

# TECHNICHE

May 2024

**SAMSUNG'S**  
NEW AI POWERED  
APPLIANCES

Rise of  
**AI**  
INFLUENCERS

**Meta Ad Library**  
*How to analyze  
Facebook Ads Library*

## Smart Farming

THE CRUCIAL ROLE OF IOT AND DRONES





**NEW  
ARRIVAL**

**50%  
OFF**

Don't miss this  
best offer!



**ORDER NOW ON amazon**



Contact Us: [natureinnovative@iemlabs.com](mailto:natureinnovative@iemlabs.com)

**nature  
innovate**

# CONTENTS

01

Explore the transformative world of IoT and AI through insightful articles

IoT/AI

07

New launches, new models, latest news from the world of technology

TECH TRENDS

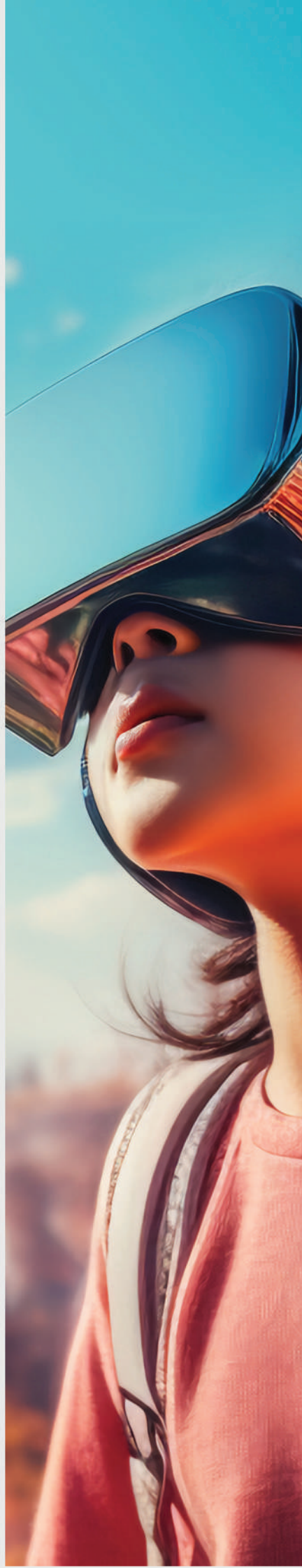

12

All about the latest and best gadgets, applications, and more

PRODUCT INSIGHTS

17

Empowering your inner creator with a blend of imagination and craftsmanship

DO IT YOURSELF

# TECH BLOGS

21

Explore the realm of IoT, AR-VR, Cybersecurity, and Cloud Computing

# CORPORATE SPHERE

33

A glimpse into the hearts and minds of innovators, entrepreneurs, and startuppreneurs

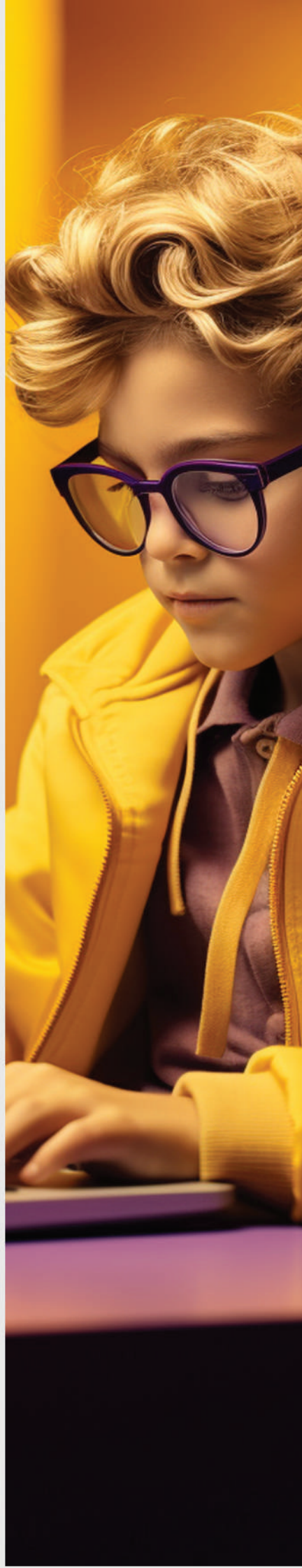

# CODING

41

Elevate your coding skills with practical examples, annotated code snippets

# REVIEWS

46

Reviews on latest tech products

# CONTENTS

# CONTENTS

**53**

Master the gadgets with our tips and hacks

**TIPS & TRICKS**

**60**

The news from the gaming and technology world

**EVENT NEWS**



**61**

A vibrant showcase of student-creativity

**STUDENTS' CORNER**

**67**

Unleash your mental prowess with brain-bending puzzles

**BRAIN GYM**

PUBLISHER:

**IEMA Research & Development Pvt. Ltd.**

# FROM THE DESK OF A VISIONARY

Dear Aspiring Techpreneurs,

I am thrilled to introduce you to the first issue of **Techniche**, a magazine that celebrates the convergence of technology and entrepreneurship. In an era where innovation is the driving force behind progress, we aim to ignite the spark of curiosity and nurture the entrepreneurial spirit within each of you.

At Techniche, we believe that technology holds the power to revolutionize industries, solve global challenges, and shape the future. However, it is the visionary minds of entrepreneurs who harness this power and transform ideas into reality. Through these pages, we endeavor to equip you with the knowledge, strategies, and inspiration to navigate the dynamic landscape of tech entrepreneurship.

Within the covers of this magazine, you will find a treasure trove of insights from industry leaders, academic experts, and successful entrepreneurs who have blazed their own trails. From ideation to product development, from coding to DIY projects, and from leadership to cutting-edge technologies, we strive to cover a comprehensive range of topics that will empower you to turn your tech-driven dreams into tangible ventures.

But Techniche is more than just a publication – it is a movement, a catalyst for change. We aspire to create a vibrant community of aspiring techpreneurs, fostering collaboration, knowledge-sharing, and the collective pursuit of innovation. Within these pages, you will find inspiring stories of resilience, case studies of groundbreaking tech ventures, and practical guidance from mentors who have navigated the intricate path before you.

We encourage you to dream big, embrace challenges, and never let setbacks define your journey. Tech entrepreneurship is a marathon, and each obstacle is an opportunity to learn, adapt, and emerge stronger. Techniche is here to be your companion, your source of motivation, and your guide towards realizing your tech-driven entrepreneurial aspirations.

Together, let us embark on this extraordinary journey, where ideas converge with technology, problems find ingenious solutions, and opportunities transform into game-changing innovations. Embrace the spirit of tech entrepreneurship, and let Techniche be your strategic partner in achieving remarkable success.

Wishing you all the best,  
**Prof. Dr. Alex Chakrabarti**  
Founder and CEO,  
Techniche Magazine



# SMART FARMING: THE CRUCIAL ROLE OF IoT AND DRONES

Agriculture, the backbone of civilization, is undergoing a revolution. Gone are the days of relying solely on intuition and experience. Today, farmers are embracing precision agriculture, a data-driven approach that leverages the power of the Internet of Things (IoT) and drones to optimize crop yields, resource management, and overall farm operations.

At the heart of this transformation lies a network of intelligent sensors deployed across the farm, collecting real-time data on various crucial aspects. Let's get into detail how IoT and drones are transforming agriculture:

## IoT with Sensors: Analyzing Soil

Healthy soil is the foundation of thriving crops. IoT with soil sensors provides a wealth of information, including:

**Moisture:** Knowing the exact moisture content allows targeted irrigation, preventing overwatering and underwatering. This translates to water conservation, reduced pumping costs, and healthier plants.

**Temperature:** Soil temperature is crucial in root development, nutrient uptake, and overall plant health. Sensors can monitor temperature fluctuations, allowing farmers to take necessary actions, such as mulching or adjusting irrigation, to maintain optimal conditions.

**Nutrient Levels:** IoT sensors can measure essential nutrients like nitrogen, phosphorus, and potassium (NPK) in the soil. This data empowers farmers to apply fertilizers precisely, avoiding waste and environmental pollution. Additionally, it helps them identify nutrient deficiencies and tailor fertilizer applications to specific field areas.



**Weather on Demand:** Forecasting for Better Yields

In agriculture, weather is a significant factor influencing crop growth and yield. Weather stations equipped with IoT sensors can monitor:

**Temperature:** Extreme temperatures can stress plants or even cause heatstroke. Real-time temperature data allows farmers to take preventive measures like frost protection or adjusting irrigation based on evaporation rates.

**Humidity:** High humidity can create ideal conditions for fungal diseases. Monitoring humidity levels allows for strategic fungicide application or adjustments to ventilation in greenhouses.

**Rainfall:** Rainfall data helps farmers determine irrigation needs and predict potential flooding risks.

## Drones in Agriculture: How Drones are Revolutionizing Smart Farming

Drones transform agriculture by giving farmers a powerful tool to increase productivity, sustainability, and efficiency. Here are some of the ways drones are used in agriculture.

### Precision Monitoring

Drones with specialized sensors and high-resolution cameras may collect precise information on irrigation systems, soil conditions, and crop health. This enables farmers to take targeted action by identifying problems early on, such as nutrient deficits, pest infestations, or irrigation concerns.

### Enhanced Productivity

Drones give farmers access to real-time data that helps them allocate resources wisely. They can apply fertilizer and pesticides more efficiently, cutting waste and guaranteeing that only the areas that require treatment are covered. This focused approach reduces environmental effects while simultaneously saving money.

### Better Decision-Making

Farmers can track crop growth and development all season long because drones can take high-resolution overhead photos of large areas. This data can be used to create comprehensive maps showing field health and forecasting possible issues. By making data-driven decisions, farmers can increase crop yields and overall farm management.

### Increased Safety

Farmers may face dangers when performing agricultural operations, such as applying pesticides across vast areas. By automating these chores, drones can protect workers from hazardous chemical exposure and maintain their safety. Drones can also be used to scout farms in remote places, which reduces the need for farmers to navigate challenging terrain.

### Streamlined Operations

Drones can now complete various jobs that used to require a lot of time or labor. They can be used, for example, to map fields, plant seeds, and monitor livestock. Farmers can concentrate on other important facets of their business with the time saved.

Although drone integration in agriculture is still developing, it is clear that drones have the potential to change the sector entirely. We can anticipate even more cutting-edge uses for drone technology as it advances, which will help ensure a more productive and sustainable agriculture in the future.





## The Benefits of Smart Farming

The adoption of IoT and drones in agriculture offers numerous benefits, including:

**Increased Crop Yields:** By optimizing soil health, irrigation, and nutrient management, intelligent farming techniques lead to larger, healthier crops.

**Reduced Resource Consumption:** Precise water application and targeted fertilizer use significantly reduce water waste and fertilizer runoff, minimizing environmental impact.

**Improved Farm Management:** Data-driven insights allow farmers to make informed decisions regarding planting schedules, resource allocation, and pest control.

**Labor Optimization:** Automating tasks like irrigation and data collection frees up valuable time for farmers to focus on strategic planning and market analysis.

**Sustainability:** Smart farming promotes sustainable agricultural practices by minimizing waste and environmental impact.

### Conclusion

The Future of Agriculture is Smart. The integration of IoT and drones is revolutionizing agriculture. By leveraging real-time data and intelligent analytics, farmers can make informed decisions, optimize resource utilization, and ensure sustainable practices. As technology evolves and becomes more affordable, smart farming has the potential to transform the agricultural landscape, ensuring food security for a growing global population.

# How The Rise of AI Influencers are Revolutionizing Social Media?

Scrolling through Insta for that fire outfit inspo or the perfect gift for your bestie? And then, BAM! You spot that ultra-glowing girl or that super suave guy all hyped up about their latest beauty haul or must-have product. You're like, "Yessss, I need that in my life!" So, you hit that follow button and become a loyal fan, right? But plot twist! What if I told you that some of your fav influencers might not be as real as they seem? Imagine finding out your ride-or-die influencer is actually a computer-generated persona programmed to chat you up and show off the latest trends. Wild, right?

Welcome to the era of AI influencers! Brands are ditching real-life peeps and creating virtual influencers that can be tweaked and tuned to match exactly what you wanna see. It's like we're living in a sci-fi movie, but this is our reality now. So, why should you care? Well, staying on top of these trends is important! Whether you're a fashionista, a tech geek, or just love a good Insta scroll, knowing what's real and what's AI can help you make smarter choices and stay ahead of the game.

## The Evolution of AI Influencers:

Let's spill some tea on the evolution of influencers. We all know and love those OG influencers, right? Like the ones who show us killer rainbow makeup looks or help us pick out the sickest projector for our gaming setups. But hold up because AI influencers are stepping up the game!

Yeah, you heard that right! These digital divas are made of pure code but look and act like they're straight out of a sci-fi movie. They've got the looks and the style, and they're always online, ready to chat about the latest trends or help you with anything, anytime, anywhere. And guess what? Half the peeps who've vibed with these AI influencers say they've had a "super positive" experience. It's like having a bestie who's always there to hype you up and share the latest details. So yeah, the future of influencing is here, and it's all about those virtual avatars bringing the heat to your feed.

## Benefits of AI Influencers:

AI influencers are revolutionizing influencer marketing by fusing novel technology with fresh, fascinating storytelling techniques. Among the key benefits for brands are:

**The cost:** By their very nature, virtual influencers are less costly than conventional celebrity endorsements. They are also extremely profitable, bringing in thousands of monthly dollars for their creators. Thanks to significant brand partnerships, Lu Do Magalu is believed to earn around \$16.2 million annually at its highest end.

**Consistency of brand:** Regardless of the content provider, virtual models are excellent at establishing a consistent brand persona across several social media channels.

**Endless options:** Due to cost or location, human influencers might not be able to create as engaging and innovative content as digital influencers can.

**Influencers beyond limits:** AI influencers are available to people anywhere in the world, regardless of where the content creator is located. Due to this, their speech and message are also easier to localize than those of human influencers in certain regions.

**Availability around the clock:** Following training, virtual influencers may interact with followers and post content anytime beyond their usual work hours.

### Issues with AI Influencers:

Even though many businesses will undoubtedly find the benefits fascinating, it's important to understand their drawbacks and obligations to customers.

**Ethical considerations:** Businesses are worried that fake influencers may dupe and mislead customers.

**Transparency:** Brands must inform consumers that their AI influencers are not human.

**Acceptance by the audience:** Since not everyone agrees with the idea of the virtual persona, businesses should expect criticism from buyers. Many see them as a threat to human originality and authenticity.

**Unusual:** The uncanny valley is one problem. Digital influencers don't age or don't experience the same daily struggles as their fans or audience. With time, users might turn away from the fake and head toward what is more authentic.

**Deviating from the norm:** Some people have a history of acting aggressively and embarrassingly out of character. Microsoft's AI chatbot Tay started sending abusive and aggressive comments via its Twitter account in 2016. Brands beware—this technology isn't flawless!

**Sexism:** A lot of famous AI figures are portrayed as female characters. Sadly, not all of this portrayal is beneficial; at worst, some of it objectifies women as sexual objects and promotes negative or false perceptions of beauty. Businesses that use virtual models to portray women must do so fairly and without turning to demeaning clichés.



## Influencers in AI in the Future:

Alright, let's dive into the future of influencing! Love them or hate them, AI influencers are here to stay. As tech like machine learning and natural language processing gets crazier advanced, these digital peeps are gonna get even more real. Imagine AI influencers blending seamlessly into our digital lives, giving us personalized shopping recs and lifestyle tips. It's like the line between the real and virtual world is getting blurrier by the day! But hold up! That doesn't mean our fav human influencers are going anywhere. Authenticity, emotional vibes, and that special human touch? That's irreplaceable.

We still gotta figure out the ethics and societal impact of AI influencers, but major brands are already hopping on the bandwagon. Ogilvy says 63% of marketers plan to use AI in their influencer campaigns by 2024! So, whether you're Team Human or Team AI, one thing's for sure – the influencer game is levelling up, and it's gonna be lit!

The rise of AI influencers is changing the game, blending tech and storytelling to give us a whole new influencer experience. But it's not all sunshine and rainbows. From ethical concerns to the need for transparency, there's a lot we need to figure out. While AI influencers bring some benefits like cost-effectiveness and round-the-clock availability, we can't forget the power of human connection and authenticity. So, whether you're all in for the digital divas or sticking with your fav human influencers, the future is gonna be wild! As we navigate this brave new world of influencing, let's keep it real, stay informed, and remember always to question what we see online.



# THE VIRTUAL EXPANSE: A SNEAK PEEK AT EPIC GTA 6 MAP

Given your intense curiosity about GTA 6 Map leaks, allow us to enlighten you with this article's comprehensive coverage of the game's map and places.

Here is an article covering all the current information about the locations and map leaks for Grand Theft Auto 6. The most recent installment in Rockstar Games' Grand Theft Auto series is Grand Theft Auto 6. Despite no official release date, the game is quite popular worldwide.



## WHAT IS THE SIZE OF THE GTA 6 MAP?

GTA 6 Map leak in 2022. The leaked information shows this map is far larger than the last one.

Vice City, also said to be the site of the upcoming gaming, is mentioned again on the map. This map will differ significantly from and be more extensive than the GTA 5 map. The recently leaked map of Vice City shows every region.

Other speculations state that Grand Theft Auto 6 is set in Miami, with certain scenes also taking place in the Florida Keys and South Everglades. The wider game environment in GTA 6 is also causing some fans to have negative concerns. The map is more significant than in the prior series. Still, only some find it repulsive!

While it's impossible to know everything about every location in the game, several have already been made public, such as Little Haiti, Malibu Club, and Washington Beach.

## LEAKS, RUMORS, AND PRESUMPTIONS

In February 2022, Rockstar Games officially announced that GTA 6 is now in active production. Nevertheless, the business experienced a significant leak that disclosed far more details about the gameplay than they would have disclosed to the public too soon.

The most recent leaks indicate that it will be launched on modern hardware. It is scheduled for release in 2024, though an official date has yet to be announced. Insiders have even conjectured that it may happen as early as 2025.

The most recent speculations about GTA 6 Maps tell a different story. Business analyst Michael Pachter believes that the new gameplay map will encompass several continents. Thus, it might be a hybrid of Europe, London, San Andreas, Liberty City, and Vice

## GTA 6 RELEASE DATE & MAP DETAILS

Excitement is building for GTA 6's release date and its richly detailed and immersive maps. According to industry insiders and rumors, the game is expected to arrive in early 2025 or 2024, despite the need for formal information about its release.

Players may anticipate a new and original terrain to traverse compared to its predecessors since the new gameplay tends to tread new ground. The Grand Theft Auto universe grows with every new version, providing players with ever-larger, more realistic areas to explore, full of fascinating side missions and tales.

Another fascinating feature of the GTA 6 Map is the inclusion of a variety of sites, both well-known and unknown. According to rumors, the game would allow players to explore a variety of bustling towns and cities, each with its unique artificial intelligence system, architecture, culture, and other social aspects.

The GTA 6 Maps offer an intriguing blend of stunning gaming environments for players to explore, whether they take in the calm beauty of a beach village or navigate the busy streets of a contemporary metropolis.



## PLACES LISTED ON THE GTA 6 MAP

Here, we'll examine the sites shown in GTA 6's updated map. Let's verify the locations on the map, even though these are merely conjectures based on the map leaks.

### VICE CITY

This city, which depicts Miami, is the leading site on the updated map. This updated map of Miami features original locations instead of those from earlier versions. Vice City is home to several notable places.

### FLORIDA KEYS

As you leave the Hamlet suburban area and head south, a highway leading to the Florida Keys is visible. The keys, which stand in for the Florida Keys, show a tiny town with a beach, an airport, and a port. Hundreds of little islands are visible above these Florida Keys.

### GRASSRIVERS

Grassrivers, often known as Grass Islands, refer to the entire western side of the island. Since there are no road signs in the region, this is the location where you guys will parade around in your airboats.

### PORT GELLHORN

The LO Prison, the LO racetrack, the Gellhorn racetrack, and St. Joseph Marina close to Port Gellhorn are all visible in the northwest region of the map.

### SUNDOWN TOWN

Gazing eastward over the mountains, you will notice Redhill, a little settlement. The Redhill Forest and Copperhead beach town are seen in the vicinity of Redhill. Sundown, named after its Sundown beach, is a nearby town of Copperhead Beach.

### MAIN ISLAND

The central portion of the island is located south of Sundown Town. There, you may see Fairyland, a small town, and the Fairyland woodland.

### AMBROSIA

The town of Ambrosia, along with the racetrack Ambrosia Tarmac and Ambrosia Farmlands, is visible next to Fairyland.

### FINAL WORDS

As far as we are aware, the official GTA 6 Map has yet to be made available to players; nonetheless, the following details about the game's map have been leaked, along with some noteworthy fan opinions. These leaks provide a fascinating look into one of the most popular game brands' futures while we await further details.

# LEVEL UP YOUR FREE FIRE MAX GAME WITH REDEEM CODES

**FREE FIRE**



Picture Courtesy: Garena

Garena Free Fire MAX, the battle royale mobile game that has taken the world by storm, offers an exciting way to test your skills and fight for survival. But what if you could enhance your gameplay and snag some awesome rewards without spending a dime? That's where redeem codes come in!

These special codes, released by Garena, grant players access to various in-game goodies, including the ever-valuable diamonds, weapon skins, characters, and more. By redeeming these codes, you can elevate your character's look, wield powerful weapons, and gain a competitive edge on the battlefield.

## What You Can Win with Redeem Codes?

The beauty of redeem codes is the element of surprise. Garena keeps the specific rewards under wraps, but generally, you can expect to score some of the following:

**Diamonds:** The in-game currency that allows you to purchase new characters, weapons, and other items.

**Weapon Skins:** Spruce up your arsenal with unique and visually striking weapon skins. These don't enhance the weapon's performance but make it look good while dominating the competition.

**Characters:** Each character in Free Fire MAX possesses unique abilities that can influence your gameplay strategy. Redeem codes might grant you access to new characters, expanding your tactical options.

**Other Rewards:** The possibilities are endless! You might score items like vouchers, consumables, and even weapon upgrades.

## Where to Find Redeem Codes?

While Garena occasionally releases codes through social media channels and official announcements, there's a dedicated redemption portal where you can find the latest codes. Here's how to access it:

Visit the official Garena Free Fire MAX redemption website (<https://reward.ff.garena.com/>).

Log in to your Free Fire MAX account using your Facebook, VK, Google, or Twitter credentials.



## TECH TRENDS

### Important Things to Remember

Redeem codes have expiration dates. Use the code as soon as possible to claim your rewards.

Codes are case-sensitive. Enter the code exactly as it appears, including any uppercase or lowercase letters and special characters.

Each code can only be redeemed once per account. Don't try to use the same code multiple times!

Codes are distributed regionally. A code that works for a player in one location might not be valid for another.

### Tips for Maximizing Your Redeem Code Experience

**Stay Updated:** Follow Garena Free Fire MAX on social media and check gaming websites regularly to stay updated on the latest redeem codes.

**Be Quick:** Redeem codes are often claimed quickly, so act fast when you see a new one!

**Share with Friends:** Spread the word! Share redeem codes with your fellow Free Fire MAX buddies so they can level up their game, too.

### Conclusion

Redeem codes are a fantastic way to enhance your Free Fire MAX experience without spending money. Following the tips above and watching for new codes, you can accumulate valuable in-game items and dominate the battlefield in style. So, what are you waiting for? Start redeeming codes today and take your Free Fire MAX game to the next level!

# SIRI 2.0? AN ON-DEVICE LANGUAGE MODEL: APPLE'S NEXT SUPERSTAR

Apple is dropping another bombshell! Get ready, as the tech giant is gearing up to unveil its next big thing: an on-device large language model. Yup, you heard it right! This new project could totally level up Apple's AI game and revolutionize how we vibe with our tech. Think Siri on steroids, but way smarter and right in your pocket. With this action, Apple hopes to alter the entire AI scene rather than just enter it. So, this is the announcement you must not miss if you love to geek out on technology and are all about staying ahead of the curve!

## What's the Buzz All About?

Bloomberg's tech guru, Mark Gurman, is revealing all! We are ready for Apple to embrace its high-risk, high-reward innovation fully. This latest attempt is a large language model made to run directly on your device rather than just another toy or gadget. Yes, Apple is turning up its AI game! With this initiative, Apple enters the ring alongside tough rivals like OpenAI and Alphabet, Google's parent company. Yes, the AI tools may be a little less potent due to the on-device operation. But remember this: we're talking about extremely quick response times and excellent user privacy. Therefore, Apple is placing an important bet on enhancing our technological interactions. These include speed, smoothness, and security—even though they may still catch up in raw power. Prepare yourself, for there will be an important shift in the tech industry!

## Why Is It Important for You to Care?

You're probably thinking, "Why should I even care?" Well, pay attention! Apple is not just playing with artificial intelligence for fun. No, they're going far beyond by highlighting how this technology can genuinely improve the quality and efficiency of our everyday lives.

Rather than just showing the raw powers of their AI tools, Apple is focusing on showcasing how this new language model could transform our daily lives. Imagine Siri being completely built into your iPhone but far smarter and more user-friendly. We're discussing more natural interactions with your gadgets, quicker responses, and customized suggestions. So, whether you're a techie who loves to use technology to simplify life or a college student balancing academics and extracurricular activities, Apple's new AI initiative is expected to significantly improve our way of life and how we interact with our gadgets.

## What to Anticipate from the Significant Announcement?

Apple has a track record of releasing products that completely revolutionize entire tech sectors. It has a history of setting trends rather than following them, starting with the Macintosh in 1984 and ending with the iPhone in 2007. What can we, therefore, hope from this much-awaited announcement?

## PRODUCT HIGHLIGHTS

**The Specifics:** Apple is expected to reveal its AI plan at the Worldwide Developers Conference (WWDC) in June of this year. This is where tech fans and developers come together to learn about Apple's latest developments. So, mark your calendars.

**The Possibility:** As per Apple's past performance, this fresh on-device language framework has the potential to alter our interactions with technology significantly. Imagine Siri with improved intelligence, more senses, and exceptional context knowledge. The endless possibilities range from more effective voice commands to customized suggestions.

## A Walk Down Memory Lane: Apple's Groundbreaking Releases:

Before delving further into the future, let us pause to recognize Apple's revolutionary accomplishments in the technology industry. Here's an overview of a few of the most famous "big things" that Apple has introduced:

**Macintosh (1984):** Steve Jobs introduced the first Apple Macintosh, which transformed personal computing with its integrated screen, mouse, and visual user interface.

**iPod: 2001:** Portable music players were changed by the iPod's sleek design and smart display.

**iPhone (2007):** The iPhone introduced us to touchscreen interfaces and app ecosystems, completely changing the smartphone market.

**iPad (2010):** With a bigger screen and more powerful hardware than a phone but less portability than a laptop, the iPad gave rise to a whole new class of gadgets: tablets.

**The 2015 Apple Watch:** The Apple Watch is a wearable smart technology that provides fitness monitoring, notifications, and more.

**Mixed Reality Headset (2023):** Apple's mixed-reality headset is predicted to bring in an entirely novel age of computing, possibly altering how we work, play games, and pass the time, even if it has received mixed reviews.

Apple is about to unveil the next big thing, an on-device language model that might significantly raise the bar for technology. Get ready to have your mind blown. We're talking about not just another awesome device but a potential groundbreaking device that could completely transform how we use technology daily. Apple is getting ready to make a splash in June at the Worldwide Developers Conference (WWDC) when they will probably publicly introduce this innovative artificial intelligence project. And let's face it, the tech world pays attention to what Apple does. You won't want to miss this news, whether you're a tech geek who is constantly searching for the next big thing, a college student trying to keep up with trends, or just someone who enjoys fascinating gadgets. We're sure that this will usher in a new era of intelligent, user-friendly technology, and you'll want to be a part of it!

# Realme 5G

## The Ultimate Budget-Friendly Phone for You

The smartphone industry is constantly changing, and 5G connectivity is the newest catchphrase. Even though flagship phones have fast speeds, their high price points may put others off. Here's where Realme comes into play, providing a selection of reasonably priced 5G smartphones without sacrificing functionality. Before choosing the best Realme 5G smartphone, explore various aspects of this.

### What Makes a Realme 5G Phone Better?

A Realme 5G phone is worth considering for several reasons.

**Affordable Priced:** The Realme phone provides 5G connectivity at a significantly lower price than some expensive flagships. This allows users to enjoy the advantages of next-generation speeds without going over budget.

**Strong Processors:** Realme equips its 5G phones with MediaTek Dimensity series processors and potent CPUs. These CPUs provide smooth performance for gaming, multitasking, and daily work.

**Powerful Batteries:** This brand knows how critical it is to maintain connectivity. Large batteries—many of which exceed 5000mAh—are found in many of their 5G phones, guaranteeing that you will have enough juice to last the entire day.

**Impressive Displays:** A strong display is crucial for any activity, including gaming, web browsing, and video viewing. It provides vivid screens with fast refresh rates for a fluid and engaging visual experience.

### Popular 5G Phones to Consider:

Selecting the best Realme 5G phone can be challenging, given the variety of models available. Let's examine a few of their best-selling products:



## PRODUCT HIGHLIGHTS

**Realme 9i 5G:** This cost-effective choice has a triple-camera setup on the rear, a powerful Dimensity 810 CPU, and a stylish appearance. It also has a sizable 6.6-inch screen with a fluid refresh rate of 90Hz.

**Realme 8 5G:** This option is fantastic if battery life is your top priority. With its large 5000mAh battery, this phone can function well for an entire day between charges. The Dimensity 700 processor also provides consistent performance for daily workloads.

**Realme 12 5G:** With its remarkable 108MP triple-camera system, this smartphone stands out for photography fans. You can take beautiful pictures and films with this phone in any lighting. The 12 5G has a clean, contemporary look and a potent Dimensity 700 CPU.

**Realme 12+ 5G:** This game will appeal to gamers. This phone's strong Dimensity 7050 processor and slick 120Hz refresh rate display guarantee a fluid and responsive gaming experience. The Sony OIS (Optical Image Stabilisation) camera on the 12+ 5G is another feature that helps it take steady, crisp pictures.

## Choosing the Right Realme 5G Model

The ideal Realme 5G phone will rely on your preferences and needs. Here are some things to think about:

**Budget:** It offers a range of 5G phones at various prices. After considering everything, choose the phone with the finest features within your budget.

**Processor:** If gaming is your top priority, choose a phone with a more potent processor, such as the Dimensity 7050 featured in the Realme 12+ 5G. The processors in other Realme 5G phones, the Dimensity 700 or 810, are more than sufficient for daily duties.

**Camera:** How many pictures do you take a day? If so, consider getting a phone with a sound camera system, such as the Realme 12 5G, which has a 108MP option.

**Battery Life:** How long do you usually use your phone during the day? If you use it frequently, Give priority to a phone with a big battery, such as the Realme 8 5G.



## Conclusion

Realme 5G phones present an alluring blend of features, performance, and cost. There is a phone that meets practically every demand, with a range of models available. Realme provides an affordable 5G experience for users on a tight budget and mobile gamers and photographers. Thus, if you want to take advantage of mobile connectivity's future without breaking the bank.

# DIY Project to Design a Circuit to Control a Multi-directional Bot through Switches



Ever wanted to build your own robot? This project will guide you through designing a simple circuit that brings a multi-directional bot to life! Using just switches and some clever wiring, you'll be able to control your bot's movement forward, backward, left, and right, giving it the freedom to roam at your command.

## Components Required

So, to get started, let's gather a few components & tools.

- 1) A Breadboard
- 2) Jumper Wires
- 3) 1 Piece of ULN2803
- 4) 2 Pieces of Toggle Switches
- 5) DC Power Supply (5V-9V)
- 6) Robot Chassis with 2 BO Motors & 2 Wheels

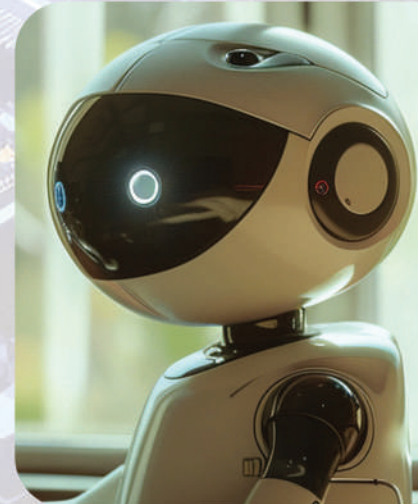

## Circuit Diagram:

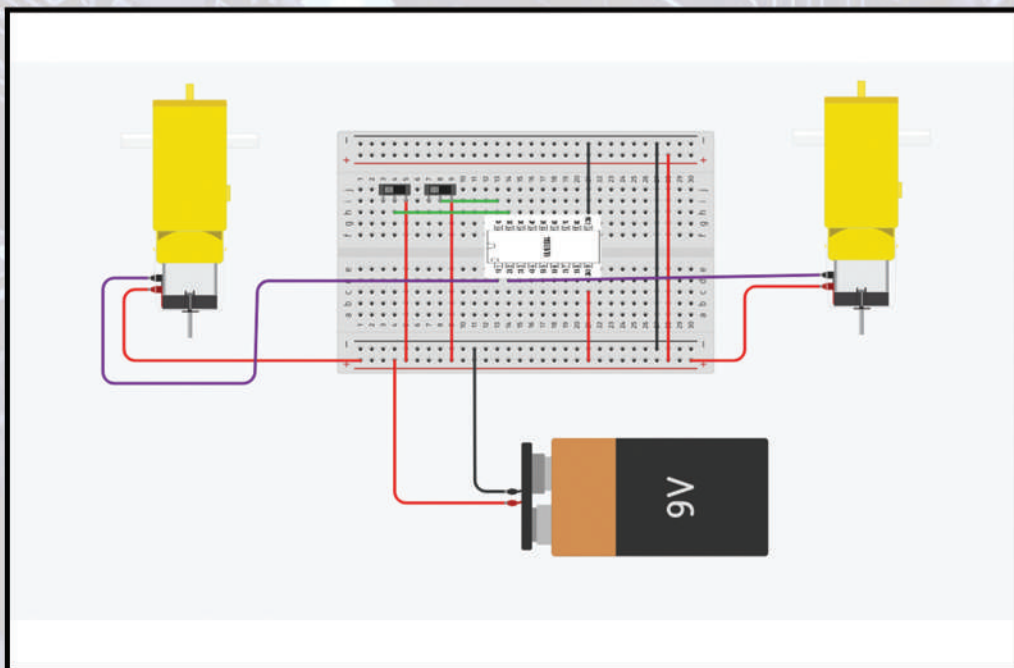

## DO IT YOURSELF

### Construction Part:

- 1) Working of the system
- 2) Overview of the components

The **ULN2803 IC** is the heart of the circuit. It is a **Darlington transistor** array IC which is capable of switching high loads with low intensity ON-OFF signals. A Darlington Transistor is an array of transistor which can amplify a very small signal into a large signal output.

Breadboard, Jumper Wires, Power Supply are required. For connecting all the modules, these are the key components required for the assembly. For Power Supply, you can purchase a 9V Battery from your nearby store.

Chassis includes the BO Motors fitted to the wheel.

Notice that we have welded the jumper wires into the terminals of the motors. Make sure that the wires are correctly connected to the board.

The battery will power the entire system.

### Main Construction

- 1) Place the switches on the breadboard like this.

These switches are a fixed position switch, so you can turn it on to one side and it will operate constantly.

- 2) Connect the 3rd pin of each switch to +ve Supply. This will ensure, that when the switch is pressed, current will flow through the switch into the circuit.

- 3) Now, let's Connect the **IC ULN2803** to the board.

This is the Darlington Transistor Array IC. It consists of multiple Input and Output ports where you can use a low level signal to turn on a much higher load, in our case, the BO Motors.

- 4) Connect Pin 9 to ground.

- 5) Connect Pin 10 to +ve Supply. This is the COM Pin and we will set it to high.

- 6) Take 2 jumper wires and connect each one to the middle of each switch.

- 7) Now, connect the other sides of those wires to IC Pin 1 & 2.

- 9) Take the positive wires and connect to +ve supply.

- 10) Connect the other 2 wires to IC Pin 18 and Pin 17.

- 11) Now, let's Check the circuit, Connect the Battery & Turn on the switches.

With a little practice and this project as your guide, you'll have a foundational understanding of how circuits control movement. This paves the way for more complex bot designs and opens the door to a world of creative possibilities!

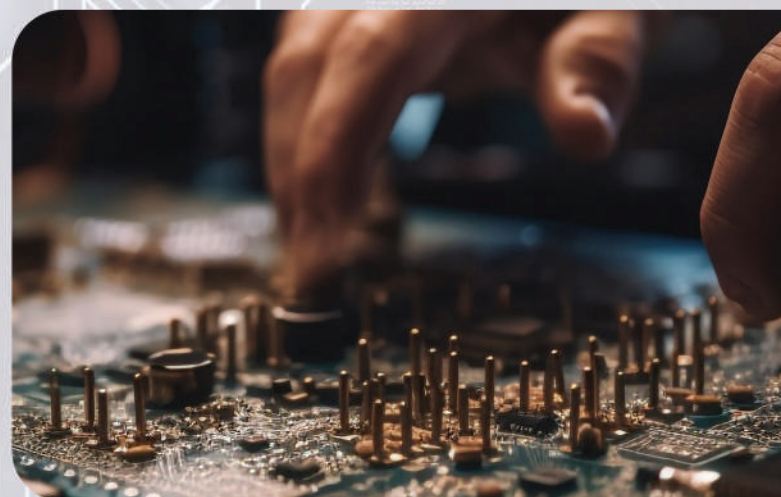
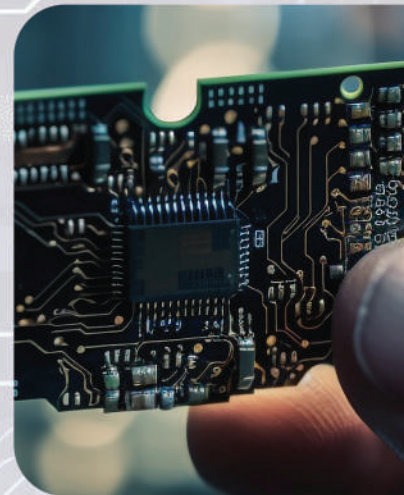



# 5-Minute Maker Hack to Build a Smart Lock Using One Transistor

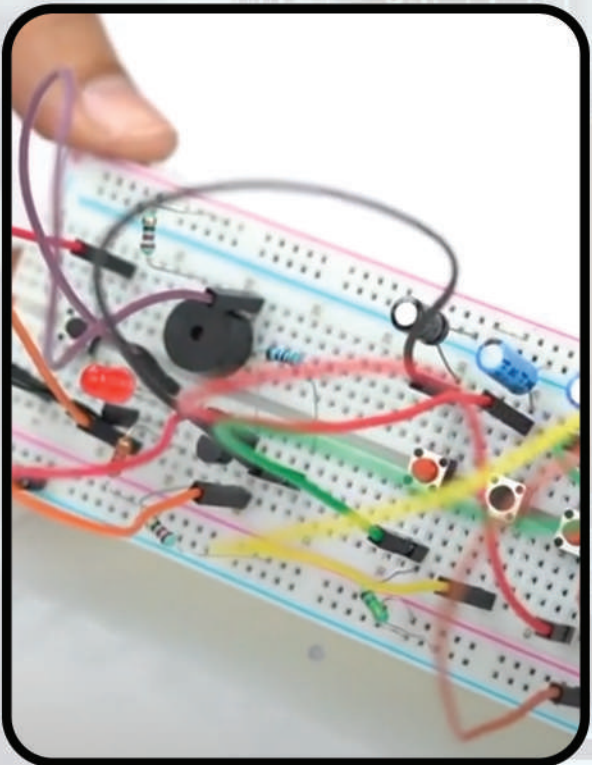
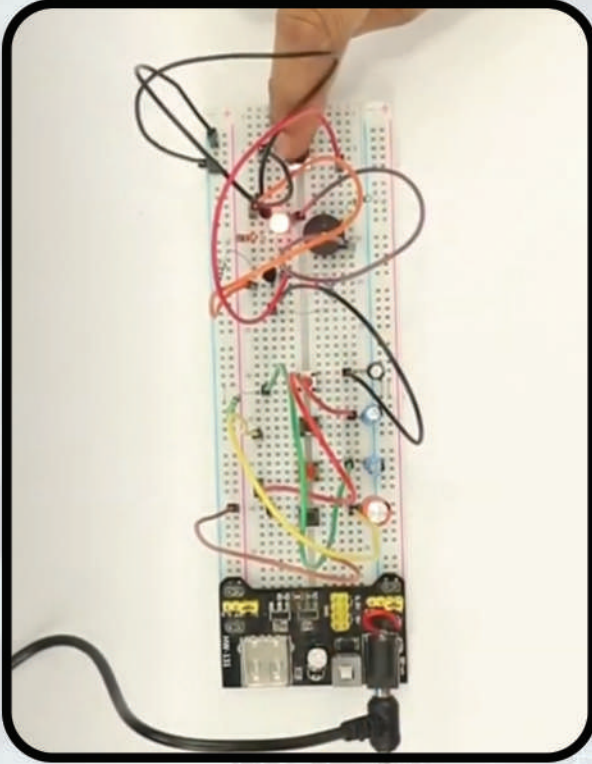

Today we will show you the process of the DIY smart lock with a 4-digit PIN Combination. You need a few components and follow our circuit to get started.

We will show you the magic of Analog Electronics circuits in this series of videos. You will learn how to use transistor logic to design interesting circuits.

Let's start.

Do it under adult supervision, if you are less than 16!

## INSIGHTS:

It can manage communications via email, answer inward-bound calls, live webchats coverage, and social media monitoring.



Small businesses can fully augment or outsource their customer service with the help of a virtual answering service.

The service complexity and the volume of the call typically are the components that decide the cost of the online answering service.

It is also known as a live receptionist, receptionist service, or virtual receptionist.

The small business that cannot afford an in-house receptionist, can use this tool for improving customer services

## Definition of Virtual Answering Service

It is a service where phone call answering can be outsourced for businesses. It covers a range of services be it as simple as message-taking or basic answering as well as delivering the entire customer service.

## The Function of Business Answering Service

A virtual answering service is a tool that is flexible relatively and businesses can tailor it according to their needs. These needs can be straightforward and simple even when it comes to being automated. Some cases might require a dedicated agent as well to carry out a conversation with callers that are guided.

This online or cloud-based service allows picking up the calls directed to one's number either through third-party operatives or an automated response to handle communication, taking messages or forwarding calls as well as handling the telephone communications.

### Components Required:

- 1) PCR406 Thyristor
- 2) BC547 Transistor
- 3) 1000uF Capacitor [x1] 4) 10uF Capacitor [x3]
- 5) Tactile DIP Switches [x5] 6) Buzzer
- 7) LED
- 8) Jumper Wires

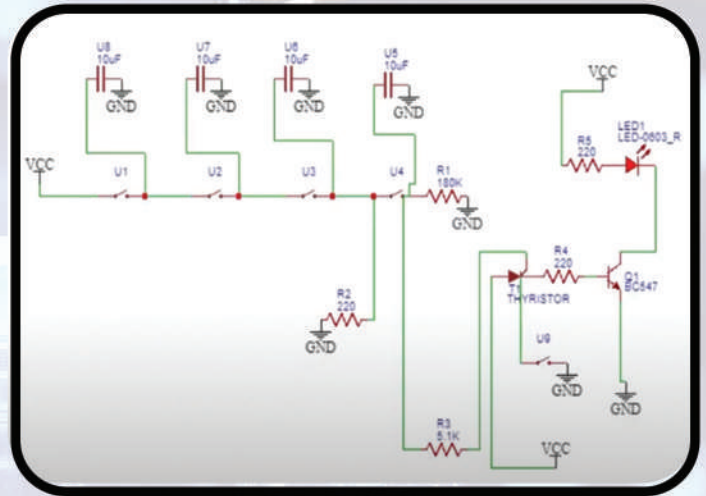

### Steps to Follow

1. Place the switches on the breadboard.
2. Place the transistor and thyristor on the breadboard.
3. Connect 180K Resistance to the 4th Switch, 220 Ohm Resistance to the other side of the switch, 5.1K Ohm Resistance to the Gate of the Thyristor, a 220 Ohm Resistance from Positive Rail to Anode of Thyristor, a jumper from Cathode to Base of BC547, Emitter of BC547 to Ground, a 1k Resistance from Positive Supply to the anode (+) of Led and Cathode of LED (-) to Collector of BC547, a 220Ohm Resistance from Positive Supply to the positive pin of buzzer and negative of the buzzer to the collector of BC547, a wire from the negative supply to the switch and another side of the switch to the Gate of Thyristor and the wiring amongst the switches.
4. Place the capacitors necessary to build the circuit on the board.
5. Check if you have connected all the wires carefully in the system. You can rewind the video or you can refer to the circuit diagram also.
6. Connect a 9V battery or a 12V Adapter to the circuit.

This is an interesting project that you can design to secure your system. You can use these DIY smart locks for many other purposes. You could also play with your friends.



## CASE STUDY

# Salesforce, Inc.

### About the Company

Salesforce, Inc. is a renowned American cloud-based software company founded in 1999 by Marc Benioff and Parker Harris in San Francisco, California. The company is recognized as a pioneer in customer relationship management (CRM) software. It has significantly impacted the tech industry with its innovative cloud computing solutions. Salesforce offers a broad range of cloud-based applications for sales, service, marketing, commerce, and analytics. It empowers businesses to streamline their operations and enhance customer engagement.

With a mission to help companies connect with their customers, partners, and employees in a whole new way, Salesforce has grown to become one of the world's largest software companies. It plays a pivotal role in shaping the future of enterprise technology.

### Timeline

#### 1999 – Founding of Salesforce

Marc Benioff and Parker Harris founded Salesforce in March 1999 with a vision to revolutionize CRM software. The company's first product, Salesforce Automation, was launched as a cloud-based CRM solution, disrupting the traditional on-premise software model.

#### 2000 – Rapid Growth and Series A Funding

Within a year of its founding, Salesforce experienced exponential growth and raised \$64 million in its Series A funding round. It was a significant achievement during the dot-com bubble.

#### 2004 – Introduction of Salesforce Platform

Salesforce unveiled its Platform-as-a-Service (PaaS) offering, known as the Salesforce Platform.

It allows developers and businesses to build custom applications on the Salesforce infrastructure.

**2006 – Initial Public Offering (IPO)**

Salesforce went public on the New York Stock Exchange under the ticker symbol “CRM” in June 2004. The IPO raised around \$110 million and marked a new phase of expansion for the company.

**2009 – Launch of Salesforce Chatter**

The company introduced Salesforce Chatter, an enterprise social networking tool enabling businesses to collaborate and share information in real-time.

**2013 – Acquisitions and Global Expansion**

Salesforce made significant acquisitions to expand its product offerings, including ExactTarget for marketing automation and Heroku for cloud application development. The company also established a strong global presence, with data centers in multiple regions to serve its growing international customer base.

**2016 – Introduction of Einstein AI**

Salesforce introduced Einstein, its artificial intelligence (AI) technology, embedded across various products. It enabled businesses to gain insights, predict outcomes, and automate tasks.

**2019 – Acquisition of Tableau**

In one of its most prominent acquisitions, Salesforce acquired Tableau, a leading data visualization and analytics company, for \$15.7 billion. Consequently, it enhanced the data analytics capabilities.

**2020 – Response to COVID-19**

Amid the COVID-19 pandemic, Salesforce demonstrated its commitment to corporate social responsibility. It provided free access to its products and resources to support businesses, nonprofits, and government organizations.

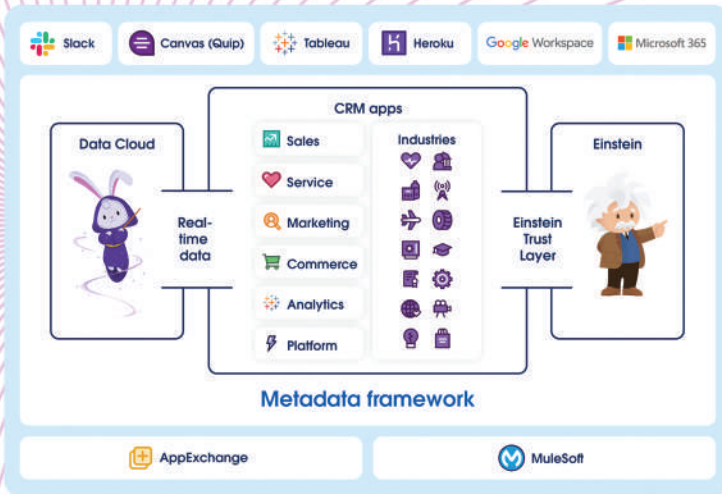

Picture Courtesy: Salesforce Inc



Picture Courtesy: Salesforce Inc

## What type of company is Salesforce, Inc. Services

It is a publicly-traded company.

### To which industry does the company belong?

The company belongs to the following industries:

- Enterprise software
- Cloud computing
- Consulting

When did the company come into existence? The company commenced operations on February 3, 1999. This was 24 years back.

### Who are the originators of the company?

The following people played a key role in establishing the firm:

- Parker Harris
- Marc Benioff
- Frank Dominguez
- Dave Moellenhoff



### Where is the headquarters of the company based?

The company has its headquarters at Salesforce Tower, San Francisco City, California.

### How many employees work for the company?

The company currently employs 79,390 workers (2023).

Salesforce, Inc. offers a wide range of cloud-based services aimed at helping businesses of all sizes manage their customer relationships, streamline operations, and drive growth. Some of the key services provided by Salesforce include:

#### Customer Relationship Management (CRM):

Salesforce is best known for its flagship CRM software, Salesforce Customer 360. This platform allows businesses to store and manage customer data, track sales lead, automate sales processes, and gain insights into customer behavior. It provides a comprehensive view of customer interactions and helps businesses personalize their engagements for improved customer satisfaction.

#### Sales Cloud:

Sales Cloud is a CRM solution designed to help sales teams manage their leads, opportunities, and sales pipelines effectively. It enables sales representatives to close deals faster, collaborate with team members, and prioritize sales activities based on real-time data.



#### Service Cloud:

Service Cloud is a CRM platform tailored for customer support and service teams. It provides tools for case management, knowledge base creation, self-service portals, and omnichannel support. Service Cloud empowers companies to deliver exceptional customer service and resolve issues promptly.

## TECH BLOGS

### **Marketing Cloud:**

Marketing Cloud is Salesforce's marketing automation platform, allowing businesses to create and execute personalized marketing campaigns across various channels. These include email, social media, and mobile. It enables targeted messaging, lead generation, and customer segmentation to improve marketing efficiency and ROI.

### **Commerce Cloud:**

Commerce Cloud provides an e-commerce solution for businesses to create and manage online storefronts. It enables a seamless shopping experience for customers and facilitates order management, inventory tracking, and personalized recommendations.

### **Community Cloud:**

Community Cloud allows companies to build private online communities for their customers, partners, and employees. These communities foster collaboration, self-service support, and knowledge sharing, enhancing engagement and loyalty.

### **Analytics Cloud (Tableau):**

Salesforce's acquisition of Tableau brought advanced data analytics capabilities to its portfolio. Tableau is a powerful data visualization and business intelligence tool that helps organizations analyze data, identify trends, and make data-driven decisions.

### **Einstein AI:**

Salesforce's AI-powered platform, Einstein, is integrated into various services, providing predictive analytics, personalized recommendations, and automation. The goal is to assist users in making smarter decisions and driving efficiency.

### **Platform as a Service (PaaS):**

Salesforce Platform provides a development environment for creating custom applications and extending existing Salesforce functionalities. It allows businesses to tailor their CRM solutions to suit their unique requirements.

### **Integration Services:**

Salesforce offers various integration tools and services to connect its CRM platform with other business applications. They allow seamless data exchange and workflow automation.

### **Mobile App Development:**

Salesforce Mobile provides tools to build custom mobile applications that enable users to access CRM data and functionalities on the go.

Overall, Salesforce's services cater to a diverse range of industries. They play a crucial role in helping businesses improve customer experiences, increase productivity, and achieve their growth objectives.



## Operations:

Salesforce's core product, Salesforce Customer 360, is a comprehensive CRM platform that integrates sales, service, marketing, and commerce functionalities. It provides a unified view of customer data. The company operates on a subscription-based model, offering different pricing tiers based on the scale and features required by customers. It primarily targets businesses of all sizes, from small startups to large enterprises.

Salesforce operates on the cloud computing model, where its software and services are delivered over the Internet. It allows customers to access and use them from any device with an internet connection. This approach eliminates the need for traditional on-premise software installations, providing customers with flexibility, scalability, and reduced IT infrastructure costs.

The company also offers various industry-specific solutions, such as Salesforce Health Cloud for healthcare organizations and Salesforce Financial Services Cloud for financial institutions. These tailored solutions cater to specific industry needs and regulatory requirements.

Salesforce's strong commitment to innovation is evident through its regular updates and improvements to existing products and the launch of new offerings. The company invests heavily in research and development to stay at the forefront of technology and to address the evolving needs of its customer base.



## Management:

Marc Benioff, one of the co-founders, serves as the Chairman and CEO of Salesforce. His visionary leadership and commitment to social responsibility have been instrumental in guiding the company's growth and success. Under his guidance, the company has become known for its philanthropic efforts and corporate activism.

The executive team at the organization consists of seasoned professionals with diverse expertise in technology, business development, and customer relations. They work collectively to drive the company's strategic direction, innovation, and operational excellence.

## Awards and Recognitions:

Over the years, Salesforce has earned numerous awards and recognitions for its innovative products, workplace culture, and corporate social responsibility initiatives. Some of the notable accolades include:

- Fortune's "Best Companies to Work For" list, where the company has consistently ranked high for its employee-friendly policies and workplace culture.
- Forbes' "World's Most Innovative Companies" list recognizes its continuous commitment to driving innovation in the tech industry.





CRM Magazine's "Market Leader" award for multiple years, establishing Salesforce as a leader in the CRM software market.

Environmental recognitions, such as being named to the Dow Jones Sustainability World Index and achieving carbon neutrality, showcase the company's focus on sustainability.

### **Controversies:**

While Salesforce has enjoyed significant success, it has not been without controversies. One of the notable controversies involved the company's contract with the U.S. Customs and Border Protection (CBP) agency. It faced criticism and protests from employees and activists, urging the company to reconsider its association with CBP amid concerns about the agency's role in immigration enforcement.

Additionally, there have been concerns over data privacy and security related to the cloud-based nature of its services. While the company invests heavily in security measures and compliance, incidents like data breaches or unauthorized access to sensitive information still occur. This potentially affects customer trust.

Salesforce, Inc. has established itself as a major player in the enterprise software market, transforming how businesses manage their relationships with customers. Through its cloud-based CRM platform and continuous innovation, the company has enabled organizations worldwide to achieve operational efficiencies and deliver exceptional customer experiences. Despite facing controversies and challenges, Salesforce's dedication to its core values and commitment to positively impacting society continue to shape its success and influence in the tech industry.

### **Acquisitions:**

Salesforce, Inc. has made several strategic acquisitions over the years to expand its product offerings, enhance its technology capabilities, and strengthen its position in the market. Some notable acquisitions include:



## Acquisitions

Salesforce, Inc. has made several strategic acquisitions over the years to expand its product offerings, enhance its technology capabilities, and strengthen its position in the market. Some notable acquisitions include:

### Tableau (2019):

One of Salesforce's most significant acquisitions, Tableau, a leading data visualization, and business intelligence software company, was acquired for \$15.7 billion. This acquisition bolstered Salesforce's analytics capabilities, allowing customers to gain deeper insights from their data and make data-driven decisions.

### MuleSoft (2018):

Salesforce acquired MuleSoft, an integration platform that enables businesses to connect various applications and data sources, for approximately \$6.5 billion. MuleSoft's technology helps Salesforce customers integrate their CRM data with other systems, facilitating seamless data flow and automation.

### ExactTarget (2013):

Salesforce acquired ExactTarget, a marketing automation and email marketing company, for around \$2.5 billion. This acquisition expanded Salesforce's marketing cloud capabilities, enabling businesses to create targeted and personalized marketing campaigns.

### Krux (2016):

Salesforce took over Krux, a data management platform, for approximately \$700 million. The acquisition helped enhance Salesforce's data management capabilities, allowing customers to manage better and utilize their customer data.

### Heroku (2010):

Salesforce acquired Heroku, a cloud-based platform for application development, for \$212 million. Heroku provides a platform-as-a-service (PaaS) solution, enabling developers to build, deploy, and scale applications without the need for managing infrastructure.

### Datorama (2018):

Salesforce took over Datorama, a marketing intelligence platform, to bolster its marketing cloud offerings. The acquisition allows marketers to unify their data from various sources and gain actionable insights into their marketing performance.





**Datora.io (2020):**

Salesforce bought Datora.io, a Brazilian technology consulting company, to expand its presence in the Latin American market and enhance its local expertise.

**Evergage (2020):**

Salesforce took over Evergage, a personalization and customer data platform, to strengthen its Customer 360 platform and provide advanced personalization capabilities to its customers.

**Financial Performance**

HEADS	AMOUNT (2023)
REVENUE	US\$ 31.35 Billion
NET INCOME	US\$ 208 Billion
OPERATING INCOME	US\$ 1.03 Billion
TOTAL EQUITY	US\$ 58.36 Billion
TOTAL ASSETS	US\$ 98.85 Billion



# Use Meta Ad Library to Get an Edge over Competitors



When you are in a business and want to retain the top spot, you must leave no stone unturned in pursuing the top spot. In this regard, the Meta Ad library is instrumental in boosting your visibility and success in business. In this article, let us find out how you can use the tool.

So, when you start searching for the ads run by your competitors, remember that their names will be the same as their Facebook page names. All you need to do is navigate to the Ad library, choose the country where your competitor has its target audience, and type in the name of the business.

From this page, you can find information about all the advertisements the competitor has run in the last seven years. While you are searching for your competitors' ads, remember that you can also access the ads in detail if you happen to use filters.

## Meta Ad Library: How to Use It?

Aside from viewing competitors' ads, let's find out why you must use the Facebook Ads library for a more in-depth analysis.

### 1. Identify or Get New Ideas

You can get ample ideas from there since you can find out the type of ads they are running for their marketing campaigns. It is not just that you can also implement a similar idea and run ads for your products and services. This is one of the ways the Facebook Ads library can help you work out plans.

### 2. Design and Adapt to Ideas to Become Unique

If you are looking for ads in the Meta Ad library, you can always tweak and incorporate a few more ideas and design the advertisement strategies accordingly. Look for the ad keywords relevant to your business and then analyze the output.



### 3. Analyzing Your Efforts

If you have not been getting the desired results from your marketing and ad campaigns all these days, you can analyze what is not right and what is not clicking. This is why you need to get the optimum yield. The only source that can help you in this regard is analyzing the competitors' strategies, which you can learn from the Facebook Ads library.

In a nutshell, use the Meta Ad library to make your ad campaigns unique. As more and more competitors rush to Facebook to make their presence felt virtual, this tool can make you a winner. The Meta Ad library is a dynamic environment where every vendor will put up his ad. You can keep tabs on each such ad and work accordingly to design your advertisements that can make you look unique.



# HOW DOES THE REACH DIRECTIVE WORK IN ELECTRONICS MANUFACTURING SERVICES?

Original equipment manufacturers (OEMs), like companies operating in many other manufacturing sectors, depend on a diverse range of chemical substances. These range from thin film metals and copper plating materials to silicon wafers, laminates, and conductive polymers. As a result, OEMs are subject to REACH, a key European Union regulation designed to safeguard human health and the environment from potentially harmful chemicals. Read this article for further details on how REACH impacts OEMs and how EMS providers can contribute to compliance with the directive.

## Registration of Chemicals

The REACH regulations, which stand for Registration, Evaluation, Authorization, and Restriction of Chemicals, require companies that introduce products to the market to record, document, and report detailed information on any chemical substances they manufacture or import into the EU if the quantity exceeds one ton per year. The report must include the specific properties of the chemicals, their uses, and guidelines for safe handling.

During the registration and evaluation process, the ECHA may raise concerns about the risks associated with the evaluated substances. In such scenarios, the Agency may require further testing. Finally, it can impose restrictions on the use of particularly hazardous substances.

## Authorization Process

If original equipment manufacturers need to use chemicals labeled as SVHCs (substances of very high concern), they must complete an additional step before including such materials in their manufacturing processes. The legal procedure in such cases involves obtaining authorization from the ECHA, which may impose specific conditions on the substance's use or restrict its application in the manufacturing processes.

## Enforced Restrictions

As previously mentioned, REACH serves as the legal basis for enforcing restrictions on using, manufacturing, and importing certain chemical substances if their assessment demonstrates that they pose intolerable risks to human health or the environment.

CMR substances suspected of causing genetic mutations, cancer, or reproductive problems, such as cadmium and lead, as well as PBT substances with high toxicity and the ability to accumulate and persist in biological organisms like mercury, are restricted according to the REACH directive.

### **Partnership with EMS Providers for Compliance with the REACH Directive**

Adhering to REACH regulations allows original equipment manufacturers (OEMs) to legally operate within the European Union while promoting their brands as global environmental and human health protection advocates in other markets.

Achieving alignment with stringent industry standards necessitates close collaboration with experienced EMS providers such as Poland-based Assel. Assel offers professional manufacturing services and ensures efficient and transparent supply chain management.

With the support of a contract manufacturer, OEMs can accurately assess whether their annual import of chemical substances exceeds the threshold levels specified in the directive. The EMS provider can assist OEMs in collecting precise and comprehensive information about chemicals eligible for the registration process mandated by REACH.

As an additional service, contract manufacturers can obtain declarations of compliance with the directive from suppliers of components and materials used in device production, further supporting alignment with the REACH regulations.

### **REACH in the EMS Sector – Conclusions**

Original equipment manufacturers must register and provide detailed information on their chemicals, undergo evaluation by the European Chemicals Agency (ECHA), and obtain authorization for substances of very high concern (SVHCs).

o streamline the complex process of adhering the device production to the REACH regulations with the assistance of a competent EMS provider, visit <https://asselems.com/en/rohs-reach-in-contract-electronics-assembly-what-is-it>



# Point of View ATMTogether.com Founder

# PAUL ALEX

## A Day in the Life of a Thriving Entrepreneur

Paul Alex didn't start his career as an automated teller machine (ATM) entrepreneur; he graduated from school with dreams of protecting his community through law enforcement. And he went on to work as a successful detective for many years before developing a side hustle related to ATMs.

He founded ATMTogether.com in January 2021 and left the law enforcement field to pursue his new passion for business. At that point, he had already built a five-figure income over five years of developing his ATM side hustle.

After becoming a full-time ATM entrepreneur, he realized he wanted to join a community of others in his field – but he quickly realized that no such community existed. So he started one online.

*"I was not on social media for seven years but decided to create a Facebook profile to network with other ATM entrepreneurs in the United States. However, I quickly realized that there wasn't a group or community where those interested or involved in the ATM business could join and share their experiences and tips with their peers and other like-minded individuals,"*

**Paul Alex explained.**





Image Courtesy: Paul Alex LinkedIn

He began by creating the “ATM Business for Beginners” Facebook™ group, which now has over 41,000 members worldwide. Founding this group provided him with much more than virtual colleagues and community. He quickly learned from the group’s members that there was no one-stop-shop to assist entrepreneurs in building their ATM businesses – but there was a need in the ATM market for location finder services.

Paul Alex built and launched the first ATM automation program to create an entire ATM business for anyone wanting to enter the ATM industry across the United States.

He christened his business ATMtogether.com as a tribute to the community he built and the teamwork he hoped to provide to aspiring entrepreneurs. Paul Alex has amassed over 1,300 clients in just a year and a half.

As a driven entrepreneur, here is a typical day in Paul Alex’s life.

## **No 2 days are the same**

*“To be fully transparent, there is no typical day. The life of an entrepreneur is basically ‘controlled chaos.’ I find it more difficult being an entrepreneur than a detective investigating criminal cases,” he said.*

One day he might walk new ATM automation clients through the onboarding process; another, he might brainstorm new sales strategies with his consultants. Of course, he also takes care of the company’s marketing, administration, and business development along with his Chief Operating Officer (COO), Gedam Yonas, and his employees.



## Being a true leader

He thrives in the high-energy, dynamic, and ever-evolving field of entrepreneurship. With a team of seventeen employees and three managers, he's learned the essential skills to motivate a team, inspire them, and keep everyone's morale up even under challenging circumstances. *"Your team will only work as hard as the leader they follow,"* Paul Alex said.

He also needed to develop skills in himself that he now teaches to his employees. For example, techniques related to problem-solving and mindset development are two topics he regularly works on with his team daily.

## When inspiration strikes

Nearly every entrepreneur talks about how they stay inspired, get their next great idea, and focus their creative energy. Paul Alex is no different and shared his favorite techniques for keeping ATMTTogether.com moving forward.

*"For me to stay disciplined and productive on a daily basis, I have several whiteboards in different rooms of my home. I also have a morning, afternoon, and evening checklist with different tasks that need to be completed daily,"* he said.

To keep track of his priorities, he always focuses on tasks that will generate revenue, placing other items lower on his priority list. He says that marketing and client acquisition trump all other categories of tasks since they are the bread and butter of his business.

With a leader like Paul Alex on their team, we're sure that any aspiring ATM entrepreneur can thrive in the unique self-employment model.

## About Paul Alex and ATMTTogether.com

Paul Alex is an entrepreneur who used to be a law enforcement officer and is experienced in the field of sales and digital marketing. Later he founded ATMTTogether.com, which is known to be an automation service that enables customers to establish their first ATM locations in different places in the United States. This organization has educated more than 41,000 rising entrepreneurs in the ATM industry. Currently, it has around 1300 clients under the ATM Automation program. To explore more, you may browse <https://go.atmtogether.com/join>.



Image Courtesy: Paul Alex Facebook

# CHRISTOPHER MITCHELL

## HIS 3 FAVORITE TIPS FOR STRUGGLING ENTREPRENEURS

Three and a half years ago, no one had ever called Christopher Mitchell the GOAT (Greatest of All Time). Why would they? He was working a traditional job in network marketing in Ohio and knew nothing about working for himself, taking a chance on his gifts, or entrepreneurship.

Today, he's a professional consultant and YouTuber, helping determined people leave the 9-5 grind and strike out on their own, to make their fortune using their smarts and talents.

His three-year-old YouTube channel boasts half a million followers, and his website has thousands of testimonials from people whose lives he has changed. But, much like most with an entrepreneurial spirit, he wants to continue to grow and scale.

He offers one-on-one coaching, his Elite Inner Circle club membership, ongoing Mastermind events, and more.

### Helping hand

Today, he helps *"everyone from single moms struggling financially that don't wanna take another part-time job to retirees and young people that simply don't want to work in offices anymore,"* he shared.





When he first started after quitting his marketing gig — much to his pregnant wife’s chagrin — he made some mistakes and ended up broke and in debt. But he never gave up on himself or his dreams. Instead, he began studying the formulas for success that could make him a winner.

With time, he regularly began making over \$100,000 monthly and reached millionaire status. He could hedge bets and leverage assets with the world’s best minds. And he decided that it was time to let others in on his secrets.

So he knows what it’s like to be a struggling entrepreneur waiting for success to happen to you.

Had he been able to go back and do it all over again, he only wished he’d had someone like himself to mentor him and show him the ropes of entrepreneurship. *“Don’t be in denial; you do need help. Find that coach. Numbers and statistics don’t lie. Unless you have a coach or a mentor with a proven track record of winning, you will keep losing. I have that recipe for success,”* he shared.

Here, the GOAT shares his three favorite tips for struggling entrepreneurs hoping that 2023 will be the year they scale.

### **Unique offer**

Mitchell shared that you must develop a solid offer based on your personal brand, beliefs, and experience. It should be carefully considered and developed — possibly with the help of a branding professional — to ensure its market resonance, evergreen appeal, and authenticity.

After putting the work into your offer, you may initially share it and get little to no reaction. *“Do not change it every week because you think it’s not working. Think about what worked for you in any area of your life and apply it to business. You have to base your offer on your experience. You have to be the expert on what you are selling,”* said Mitchell.

### **Find your tribe**

Once you start developing a client base and following, create something special for your most ardent supporters.

## CORPORATE SPHERE

A place they can feel at home and connect with other entrepreneurs, students, or learners interested in the same things.

*“Create an elite club – something special for your clients. Whether it’s a secret group, regular Zoom calls, Mastermind events, or whatever is in line with your business. The point is to make your biggest supporters feel as special as your students. Your clients are your tribe,”* said Mitchell.

## About Christopher Mitchell

Christopher Mitchell is the Top Professional Gambler and Gambling Consultant in the world. He teaches people how to find success in casinos in Baccarat, Roulette, Sports Betting, and more.



## Develop one platform

Let’s be honest. If you consistently shared high-quality content across every social media platform, you’d probably not have enough time or energy to pursue your business. Yet you do need a solid online presence.

Mitchell’s advice is to give your time to the platform that gives you joy. For him, that’s YouTube. So he develops quality content and posts consistently, and it’s paid off for him. His advice is, *“Be consistent, be recognizable, and connect with people.”*

As one of the top entrepreneurs in his field and someone who went through lean years to find success, we’ll certainly take Mitchell’s expert advice to heart.

After losing \$500,000 in the Casinos, Christopher finally figured out how to win and created his personal recipe for success, which includes specific tips, rules, and strategies to follow. He shares winning formulas with others worldwide through his private Inner Circle, exclusive Mastermind Events, and his personal one-on-one coaching program.



# Victor Orlovski

## *What Makes Successful Entrepreneurs Stand Out?*

One of the key qualities inherent in every leader is the ability to take responsibility for risks. According to expert Victor Orlovski, unlike managers, who act as links in the overall management chain, entrepreneurs generate income based on the risks they take. However, many successful individuals sometimes adhere to completely different principles in business. But which principles can lead a company to prosperity?

Victor Orlovski gives an example from the book *'The Ideal Executive: Why You Cannot Be One and What to Do about It'* by the famous strategy consultant Ichak Adizes. In the book, the author examines three main character types – the “ideal leader,” the “ideal administrator,” and the “ideal integrator”. At the same time, multiple personality traits are considered to identify the characteristics of a leader who would possess only one of the three competencies.

For a better understanding, the book provides the following example. Three people – a “leader,” an “administrator,” and an “integrator” are looking out a window. What do they see? The “leader” sees the horizon and the mountains lining it, the valleys, and a bridge that has not yet built across a river but is already at the design stage. The “administrator” notices the poor workmanship of the frame and the grime, the quality of the finishing, and other superficial features. The “integrator” does not look out the window, nor does he take note of the details of the room around him. Instead, he carefully watches the “leader” and the “administrator.”

*“The qualities and skills that give a true leader the edge necessary not just to survive, but thrive in business.”*

## CORPORATE SPHERE

Clearly, people, especially entrepreneurs, who have developed only one of the three qualities described herein do not exist in nature. But this example, according to Victor Orlovski, illustrates the strengths of leaders, which can propel them to success.

### **Types of Entrepreneurs from the Perspective of Victor Orlovski**

One of the types of entrepreneurs that Victor Mikhailovich Orlovski singles out can be called “operators.” Such executives have the necessary managerial skills to run a business since they prefer to immerse themselves in the relevant processes and build them from the ground up independently. Such an approach gives them an in-depth understanding of their business. It is difficult for them to run several businesses at once, but they can change their areas of activity quite radically. And in each case, they get completely absorbed by the project they have engaged in.

The second type is the “investors”. These are strategists who distribute their investments across profitable industries. They do not get involved in any operational aspects but instead find suitable managers or entrepreneurs ready to build the business. Victor Mikhailovich Orlovski is convinced that the “investor’s” primary role is their willingness to commit and invest in business, to risk their own or attract funds. That is why their ability to look into the future and select the right specialists as managers is of such importance. If we compare these two types of entrepreneurs, the first often concentrates on their risks, while the second tries to diversify them.

According to Victor Orlovski, the next type could be “speculators”. Despite the term’s negative connotation, such people have a quick mind and know how to coordinate their actions to get rich rather quickly. The key features of these entrepreneurs are their ability to navigate current circumstances and find effective solutions instantly. According to Victor Mikhailovich Orlovski, a speculative business is no worse and no better than any other. It requires a flexible approach and is characterized by high risks.



Orlovski Victor draws the following analogy for the types of entrepreneurs in nature – the “operators” are herbivores that can be as powerful as elephants or rhinos. The “investors” are the predators that include both small and large species. The “speculators” are scavengers, like bacteria and detritivores, which break down organic matter into constituent components and fertilize the soil. Which of these types is of greater significance? According to Victor Orlovski, each type bears its weight because they all ensure life and business continuity.

According to Victor Mikhailovich Orlovski, ideal entrepreneurs do not exist, but each may have the skills inherent in all three categories to a different extent. Of course, specific character traits influence the development of these abilities separately. The choice depends on individual goals, financial capabilities, and risk tolerance, with the determining factors being sound planning and judgment when making business decisions.

# AUGMENTED REALITY DEVELOPMENT WITH UNITY



This covers code snippets and explanations for various aspects of developing augmented reality (AR) applications using the Unity game engine, including:

## **Markerless Augmented Reality**

### **Google ARCore Plugin**

### **Vuforia Integration**

### **Mixed Reality Toolkit (MRTK)**

### **Optimization Techniques**

### **Mixamo Animations**

The content provides sample code and explanations for implementing markerless AR, using the Google ARCore and Vuforia SDKs, working with the Mixed Reality Toolkit, optimizing AR applications, and integrating Mixamo animations into Unity projects.

## CODING

**Markerless Augmented Reality:** Markerless Augmented Reality is a technique that does not require predefined markers or targets to overlay virtual objects onto the real world. Instead, it relies on advanced computer vision algorithms to detect and track real-world features, such as edges, corners, and textures, to anchor the virtual content.

```
// Using ARCore's ARPlane class for markerless AR
void PlaceObjectOnPlane(ARPlane arPlane)
{
    // Create an anchor at the center of the plane
    Pose pose = arPlane.CenterPose;
    Anchor anchor = arPlane.CreateAnchor(pose);

    // Instantiate a 3D object and parent it to the anchor
    GameObject obj = Instantiate(objectPrefab, pose.position, pose.rotation);
    obj.transform.parent = anchor.transform;
}
```

In this example, we use ARCore's ARPlane class to detect real-world surfaces and create anchors on them. The PlaceObjectOnPlane method takes an ARPlane object, creates an anchor at its center, and then instantiates a 3D object parented to that anchor. This way, the virtual object remains anchored to the real-world plane as the user moves around.

**Google ARCore Plugin:** The Google ARCore plugin for Unity allows developers to create Augmented Reality experiences on Android devices. Here's an example of how to set up and use the ARCore plugin:

```
using Google.AR.Core;
using UnityEngine.XR.ARFoundation;

public class ARCoreManager : MonoBehaviour
{
    private ARCoreSession arCoreSession;

    void Start()
    {
        // Create an ARCoreSession
        arCoreSession = new ARCoreSession();

        // Set the ARCoreSession as the active XR session
        ARCoreSessionSubsystem.SetARCoreSessionComponent(arCoreSession);
    }

    void Update()
    {
        // Update the ARCoreSession
        arCoreSession.Update();
    }
}
```

In this example, we create an ARCoreSession object, which is a component required by the ARCore plugin. We then set this session as the active XR session using ARCoreSessionSubsystem.SetARCoreSessionComponent. Finally, we call arCoreSession.Update() in the Update method to keep the AR experience running.



## CODING

**Vuforia Integration:** Vuforia is a popular Augmented Reality SDK that supports both marker-based and markerless AR experiences. Here's an example of how to integrate Vuforia into a Unity project:

```
using Vuforia;

public class VuforiaManager : MonoBehaviour
{
    private VuforiaBehaviour vuforiaBehaviour;

    void Start()
    {
        // Get the VuforiaBehaviour component
        vuforiaBehaviour = GetComponent<VuforiaBehaviour>();

        // Register for the OnTrackingFound event
        vuforiaBehaviour.OnTrackingFound += OnTrackingFound;
    }

    void OnTrackingFound()
    {
        // Get the tracked target
        TrackableResultData targetData = vuforiaBehaviour.TargetFinder.CurrentlyTrackedTarget;

        // Instantiate a 3D object at the target's position and rotation
        GameObject obj = Instantiate(objectPrefab, targetData.TargetPose.Position, targetData.TargetPose.Rotation);
    }
}
```

In this example, we get a reference to the VuforiaBehaviour component, which is required for Vuforia integration. We then register for the OnTrackingFound event, which is triggered when Vuforia detects a target (marker or markerless feature). In the OnTrackingFound method, we obtain the tracked target data and instantiate a 3D object at its position and rotation.

**Mixed Reality Toolkit (MRTK):** The Mixed Reality Toolkit (MRTK) is a cross-platform toolkit for building Mixed Reality applications. It provides a set of components, input handlers, and utility scripts to simplify the development process.

```
using Microsoft.MixedReality.Toolkit.Input;
using Microsoft.MixedReality.Toolkit.Utilities;

public class MRTKExample : MonoBehaviour
{
    private void Start()
    {
        // Register for the input events
       .MixedRealityToolkit.Instance.GetService<IMixedRealityInputSystem>().RegisterHandler<IMixedRealityPointerHandler>(this);
    }

    void IMixedRealityPointerHandler.OnPointerDown(MixedRealityPointerEventData eventData)
    {
        // Get the raycast hit information
        FocusDetails focusDetails = eventData.Pointer.Result.CurrentRaycastResult.FromRaycastHit(eventData.Pointer.Result.CurrentRaycastResult.Hit);

        // Instantiate a 3D object at the hit point
        GameObject obj = Instantiate(objectPrefab, focusDetails.Point, Quaternion.identity);
    }

    void IMixedRealityPointerHandler.OnPointerUp(MixedRealityPointerEventData eventData) { }
    void IMixedRealityPointerHandler.OnPointerClicked(MixedRealityPointerEventData eventData) { }
}
```

In this example, we implement the IMixedRealityPointerHandler interface to handle input events from the MRTK input system. In the OnPointerDown method, we get the raycast hit information from the pointer event data and instantiate a 3D object at the hit point.

## CODING

**Optimization Techniques:** Optimization is crucial for AR applications to ensure smooth performance and a great user experience. Here are some common optimization techniques:

**Level of Detail (LOD):** Adjust the mesh complexity and texture resolution of 3D objects based on their distance from the camera.

**Occlusion Culling:** Disable rendering for objects that are not visible to the camera.

**Frustum Culling:** Only render objects that are within the camera's view frustum.

**Batching:** Combine multiple draw calls into a single draw call to reduce overhead.

**Asynchronous Loading:** Load assets asynchronously to avoid stalling the main thread.

```
using UnityEngine.Rendering;

public class OptimizationExample : MonoBehaviour
{
    void Start()
    {
        // Enable occlusion culling
        Camera.main.cullingMask = ~(1 << LayerMask.NameToLayer("OccludedObjects"));

        // Enable frustum culling
        Camera.main.cullingMask |= (1 << LayerMask.NameToLayer("RenderedObjects"));

        // Set up LOD settings
        maximumLODLevel = QualitySettings.maximumLODLevel;
        LODSettings.SetLODSettings(lodBias, maximumLODLevel);
    }
}
```

In this example, we enable occlusion culling by excluding objects on the "OccludedObjects" layer from the camera's culling mask. We also enable frustum culling by including objects on the "RenderedObjects" layer in the culling mask. Finally, we set up Level of Detail settings by adjusting the lodBias and maximumLODLevel values.

## CODING

**Mixamo Animations:** Mixamo is a web-based service that provides a library of character animations that can be easily imported into Unity. Here's an example of how to import and use Mixamo animations:

```
using UnityEngine;

public class MixamoAnimationExample : MonoBehaviour
{
    public GameObject characterPrefab; // The character GameObject with the Mixamo rig and animations

    private Animator animator;

    void Start()
    {
        // Instantiate the character prefab
        GameObject character = Instantiate(characterPrefab);

        // Get the Animator component
        animator = character.GetComponentInChildren<Animator>();
    }

    void Update()
    {
        // Play the "Walk" animation
        animator.SetBool("isWalking", true);
    }
}
```



## Future of Home Living

# Samsung's New AI-Powered Appliances

Samsung, a leading global technology company, has made headlines once more with the introduction of its AI powered home appliance line, the Bespoke Series. The much-awaited Welcome to Bespoke AI event, which was hosted in three major cities—Seoul, Paris, and New York City—featured the announcement.

### AI-Powered Appliances: A Novel Era

Samsung has made tremendous progress this year by incorporating artificial intelligence (AI) into its products. This connection makes a plethora of additional features and capabilities possible, greatly improving the user experience.

## REVIEWS

To further ensure the highest level of user data privacy, Samsung has strengthened its connected appliances using the Knox security platform.

Samsung Electronics Vice Chairman, CEO, and Head of the Device Experience Division (DX) Jong-Hee Han made the announcement. He highlighted Samsung's ambition for AI-enabled appliances and how improving connectivity and leveraging AI capabilities builds on the Bespoke history.

Attendees were given a preview of the future of home living using artificial intelligence (AI) technology at the Experience Zone. Every element of the smart home experience was painstakingly designed to delight and inspire, from the Security & Easy Connection Zone—where Samsung Knox and Smart Forward guarantee seamless device upgrades and the highest security standards—to the Bespoke AI Experience Zone, which boasts user-friendly features like Tap View on the Bespoke 4-Door Flex Refrigerator with AI Family Hub™+.

## Introducing the Customized Series

With a total of 14 products released, Seoul had the most range of product lineups on display at the event. The Bespoke French Door Refrigerator with AI Family Hub, the Bespoke Cube Air Infinite Line, the Bespoke AI Laundry Combo, the Bespoke Jet Bot Combo AI, and the Bespoke French Door Refrigerator with AI Family Hub are all part of the Bespoke Series. These devices have AI chips, inbuilt cameras, built-in Wi-Fi, and compatibility with the SmartThings app.



## REVIEWS

Visitors had the chance to engage directly with the 2024 Bespoke AI goods to experience cutting-edge capabilities like AI Vision Inside for food package expiration checks and tailored recipe recommendations through Samsung Food. The Bespoke AI Laundry Combo™ and Bespoke Jet Bot Combo™ demonstrated how cutting-edge technology and user-centered design can come together to provide unmatched efficiency and ease for domestic tasks.

### Presenting New Functionalities

Samsung's Bespoke Series introduced several new features. One noteworthy feature is the AI Home, a 7-inch LCD panel integrated into several goods that enables simple access and management over the entire connected ecosystem. Users of the AI Home can play media and music, manage many appliances at once, see cooking recipes, and more.

Another cutting-edge addition is the Mobile Smart Connect capability. When a user's phone approaches a registered appliance, this feature notifies them and offers a quick control menu that allows them to perform essential tasks right from their phone. The seamless registration process for Samsung's SmartThings app has further enhanced the onboarding experience.

### Innovations Particular to a Product

Every item in the Bespoke Series has a unique set of advances. AI Vision is present, for example, in the refrigerator. The AI Home uses an inbuilt camera to recognize 33 fresh food items and suggests recipes that you can create with ingredients in the fridge.

A robot vacuum cleaner called the Bespoke Jet Bot Combo AI can identify a wide range of items. It can identify people, animals, thin phone lines, and carpets or rugs. It can also sense the kind of surface that has to be cleaned as well as the method.

The AI Energy Saving Zone and AI Technology Zone were all about energy savings. Samsung's AI Energy Mode stands out for its



The business showcased ground-breaking projects in the For a Sustainable Future Zone to further demonstrate its dedication to sustainability and innovation. The AI Inverter Compressor and microplastic-reducing filters are such examples.

### Using AI to Improve Bixby

Lastly, Bixby, Samsung's built-in voice assistant for smart home appliances, will now have generative AI capabilities.

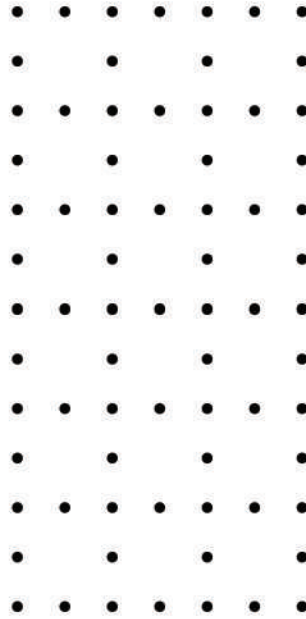

Thanks to AI integration, Bixby can now comprehend multi-layered activities, contextual requests, and complicated statements. When a user says, *“The living room feels humid,”* for instance, Bixby will recognize the situation and offer suggestions.

## Final Words

To sum up, Samsung’s AI-Powered Bespoke Series of home appliances is evidence of the company’s dedication to innovation and client happiness. They are incorporating AI into its devices. Samsung is thus changing how we interact with household appliances and improving their usefulness at the same time. Samsung is genuinely delivering the appliances of the future to our doorsteps with the Bespoke Series.

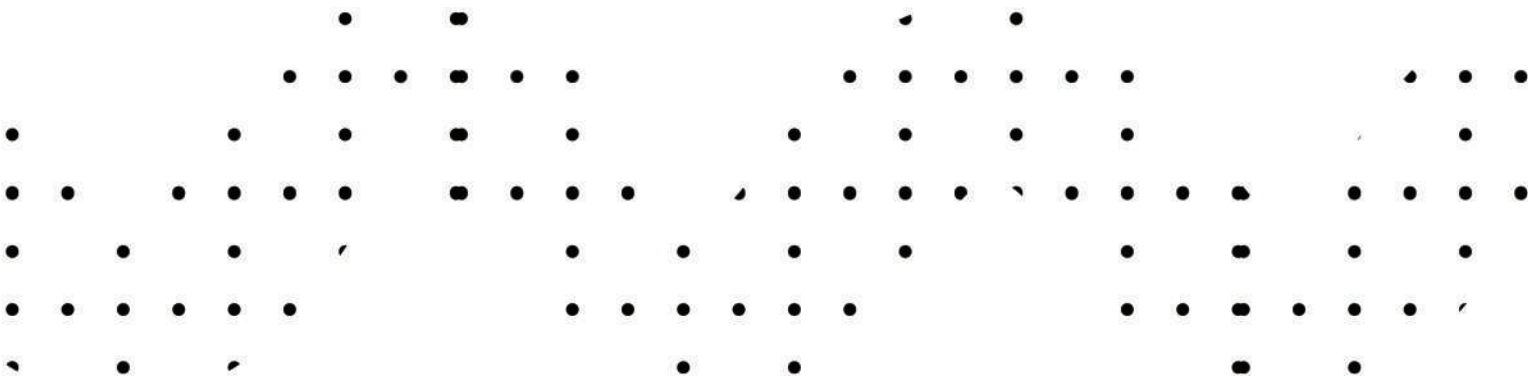

# LG vs Samsung TV

## A Comparative Analysis of TV Technologies



Choosing between many different brands and features when buying a new TV might need to be clarified. But if you're having trouble deciding between an LG vs Samsung TV, we can help. In this post, we'll contrast the two brands and discuss which provides the best value. We'll also consider other crucial elements like cost, features, and quality to help you choose the best product for your house.

This guide will assist you in selecting the ideal TV for your needs in terms of price and lifestyle. We will help you locate the best model for your requirements, whether you're searching for an expensive alternative for daily use or an elite model to enjoy your new gaming console.

### Overview of LG Vs Samsung TV

Large-scale tech companies Samsung vs LG TV offer some of the best TVs available today for both high and low-price ranges, yet many high-end models have differing panel technologies. While you don't need to know, these distinctions could be crucial. They also have a sizable install base and a wide selection of new televisions introduced annually.

Comparing prices is challenging, considering the annual volume of sets that LG and Samsung release. For super-sized sets that cost thousands of dollars or pounds, both manufacturers offer some of the best 32-inch smart TVs, some of the best 4K TVs, and even some of the best 8K TVs. Either brand will meet your needs for a new TV in size, shape, resolution, and price.

### Categories of Television

LG and Samsung offer a wide selection of televisions to meet the demands of diverse consumers. Samsung TVs come in various types, including 4K UHD HDTVs, 8K QLED models with AI upscaling technology, and fantastic outdoor TVs for entertaining on decks or patios. LG TVs are available in three different versions: 1080p LED HDTVs offer HD visual quality at a lower cost; 4 K OLED models offer remarkably vibrant color detail; and smart TVs offer integrated streaming capabilities.

### A Platform for Smart TVs

LG vs Samsung TVs each have their own in-house smart TV platform. Tizen from Samsung and webOS from LG are widely regarded as two of the greatest smart TV operating systems. There are a few variations, but they are quick and loaded with the newest apps.

LG has been at the forefront with webOS, a simplistic smart TV interface. It has a horizontal menu bar for frequently used apps, inputs, and streaming services.

The layout of Samsung's Tizen OS is similar. The OS reduces clutter, but occasionally, this makes navigation more difficult because there are many instances in which you need to search for a specific app. The primary distinction is that LG's ThinQ AI software has a better search algorithm than this one.



## REVIEWS

Google Assistant is integrated into LG's OLED and Super UHD televisions, and there is some restricted connectivity with Alexa-enabled devices. Again, limited to mid-range or premium sets, Samsung employs its own first-party Bixby assistant, with the option to use Google Assistant or Alexa through third-party devices.

## Panel Technology

The two-panel technologies used in today's premium television market are OLED and QLED.

An organic light-emitting diode, or OLED, is a type of TV panel that emits light on its own rather than allowing light to pass through it. One advantage of an OLED TV is that it allows for incredibly small TV panels and pixel-by-pixel brightness adjustment.

OLED screen "burn-in" pictures are a common topic of discussion. However, most of the information on this topic is anecdotal, and it would likely take a lot of use for this to become an issue.

Conversely, QLED is a Samsung-developed patented technology. Instead of being able to adjust brightness for every pixel on the screen, QLED uses a filter made of quantum dots to improve color and contrast. It also makes do with multiple dimming zones. Additionally, QLED TVs are far brighter than OLED TVs, so they may find it challenging to display light and dark pictures simultaneously.

OLED screens are typically best suited for high-quality video formats in dimly lit areas, while Samsung sets fall short in contrast but more than makeup for it with vivid and striking displays.

## Formats

Both TV makers support a slightly different high dynamic range (HDR) format. Samsung prefers HDR10+ for its premium TVs, while LG packs Dolby Vision into its top line of OLEDs and Super UHDs.

Both formats adjust the television's output to the content being shown using a feature known as dynamic metadata. For example, scenes depicting brightly lit drawing rooms or dimly lit underground dungeons change the television's brightness, contrast, and picture processing settings correspondingly.

Since Dolby Vision is more widely available and has a 12-bit color range as opposed to 10-bit HDR10+, it is the more sophisticated format.

While it is true that at the higher end of the price range, the preferred HDR format becomes less of an issue, large spenders should carefully consider which services they are most likely to desire HDR material on.



## Which One Should You Select?

So, which one should you pick, LG vs Samsung TV? The top brand of TVs on the market right now is Samsung, but your choice depends totally on you, your tastes, and whether any of the distinctions we've listed above are unacceptable. However, it's important to remember that you should compare like to enjoy. For example, a high-end set from Samsung could perform less well than a budget set from LG, and vice versa.

Nothing presently surpasses LG's OLED screens for color and contrast if you're searching for the best picture quality available, regardless of price.

A Samsung or an LG TV will satisfy you, but understanding the main distinctions between their smart TV platforms, display technologies, and formats should help you choose the best TV brand. After going through this on LG vs Samsung TV discussion, you can decide opt for a specific TV.



# Capturing Creativity: How to Do Pinterest Image Download

It's odd that despite having a large user base, Pinterest is one of the social media sites that gets the least attention. With its focus on images, Pinterest facilitates the discovery of original ideas. Pinterest includes everything you need, including recipes, DIY projects, quotes, clothing, and accessories. Images from Pinterest can be downloaded straight to your computer or mobile device. Videos, stories, and downloads are currently not supported on Pinterest. To learn how to do Pinterest image download, continue reading.

## Saving Pinterest Images to Your Gallery

Among the most addictive websites is Pinterest. You will want to continue using it once you start. You can save or bookmark anything interesting in one of your boards. The tools for visual bookmarking are boards. On Pinterest, you can create many Boards. These Boards can be shared with others and made public or private.

Fortunately, Pinterest has a built-in feature that allows you to save photographs. In this article, we'll explain how to do a Pinterest image download to your gallery on desktop and mobile devices.

## How to do Pinterest Image Download to an Android Gallery?

**Step 1:** Open the Pinterest app on your Android device. On your phone, open the image you wish to download.

**Step 2:** Next, tap the icon with three dots in the upper-left corner. Choose Download image from the menu that appears. If this is your initial download from Pinterest, an authorization request will be made to access the material on your device. To give permission, tap Allow. Upon downloading the image, a little popup titled "Image saved" will appear at the bottom of the screen.

**Step 3:** Next, locate the Pins folder using the Gallery app on your phone. This is where you can find the Pinterest image that you just saved. Additionally, this folder will contain all of your future Pinterest images.



## How to Get Pinterest Photos on an iPhone?

**Step 1:** Locate the image you wish to download by opening the Pinterest app on your iOS device.

**Step 2:** Tap the icon with three dots on the top bar. Choose Download Image from the pop-up menu.

If your iOS device displays a permission problem, click Phone Settings and select Privacy. Select Photos from the Privacy menu. Next, search for Pinterest and press on it. Select Read and Write on the following screen, which reads Permit Photos Access.



## Download Images from Pinterest to Your PC

Regretfully, Pinterest doesn't offer a desktop image download option. You will need to use your browser's native download function. Here are the steps.

**Step 1:** On your computer, open the Pinterest website. After that, click the picture you wish to download.

**Step 2:** Hover your cursor over the image on the next screen, then choose it with a right-click. Select Save image as. You will be required to select the image's name and download location. Click Save when you're done.

## The Process of Downloading Multiple Images from a Pinterest Board

There is a way to download several pictures from a Pinterest board to your computer. The Chrome plugin known as Image Downloader is what you must utilize. The add-on works with more than just Pinterest. It allows you to download several pictures at once from any website.

### The Steps To Download Pinterest Image Are as Follows:

**Step 1:** Launch Chrome on your computer. Then, click this link to add the Image Downloader Chrome extension. Once the extension has loaded, click the Add to Chrome button.

**Step 2:** The Image Downloader icon will appear in Chrome's top bar after installation. Open Pinterest now, and select the board where you wish to get picture downloads.

**Step 3:** Next, select the icon for the Image Downloader. You can click an image once in the pop-up window to avoid downloading it. It will no longer be available for selection.

**Step 4:** Press the Download button to finish. A popup alerting you to the possibility of additional download windows opening will appear if your Chrome setting is set to always ask the location before downloading. Hit the "yes" button if that's alright. If not, select No.

First, we must check the download settings to prevent multiple save windows. To do so, click the three dots in Chrome's upper-right corner, then choose Settings from the menu.

Click Advanced under Settings. Next, click Downloads and uncheck the box "Ask where to save each file before downloading." Proceed to steps 3 and 4 again after turning it off. Click Yes when the extension asks you to resume the download. The photos on that page will all be downloaded using Chrome.

## Get Your Pinned Interests Downloaded

You can make digital scrap boards on Pinterest by gathering pictures and videos related to different subjects. When you log in online, you can find the photos you like without constantly searching for them. They'll be directly accessible to you through the boards you follow and your own.

You can save specific images from Pinterest to your device for offline and personal usage. Additionally, you can use the Image Downloader Chrome extension to save all of the photographs from a board to your PC.

## Conclusion

Are you wondering how to get a Pinterest image download? This in-depth guide will cover all the ground, whether you're a marketer searching for graphic content for your projects or a frequent pinner looking to store ideas.



# 6 Best Free YouTube Downloaders in 2024 (MacOS & Windows)

You will all agree that YouTube is the best place to browse. When you want to unwind a little, what would you do? Browse Vlogs of internet celebrities on YouTube and watch enlightening videos on it. Since YouTube is almost connected to everything, it makes sense that you might feel the urge to download your preferred YouTube videos. But how?

This article has collected 6 of the best YouTube video downloaders for 2024 in detail, which might be helpful to you whether you use Windows or MacOS. Just buckle up and keep

Although it includes several advanced features, they are relatively easy to use. With its support for batch downloads, video conversion, audio extraction, subtitle downloads, and more, you may simultaneously download or convert all of your preferred YouTube videos, playlists, or channels. Most importantly, the download process can be completed in a short time!

The feature-full video downloader is so functional that you can download videos blocked in your area thanks to its in-app proxy setup that bypasses YouTube's regional

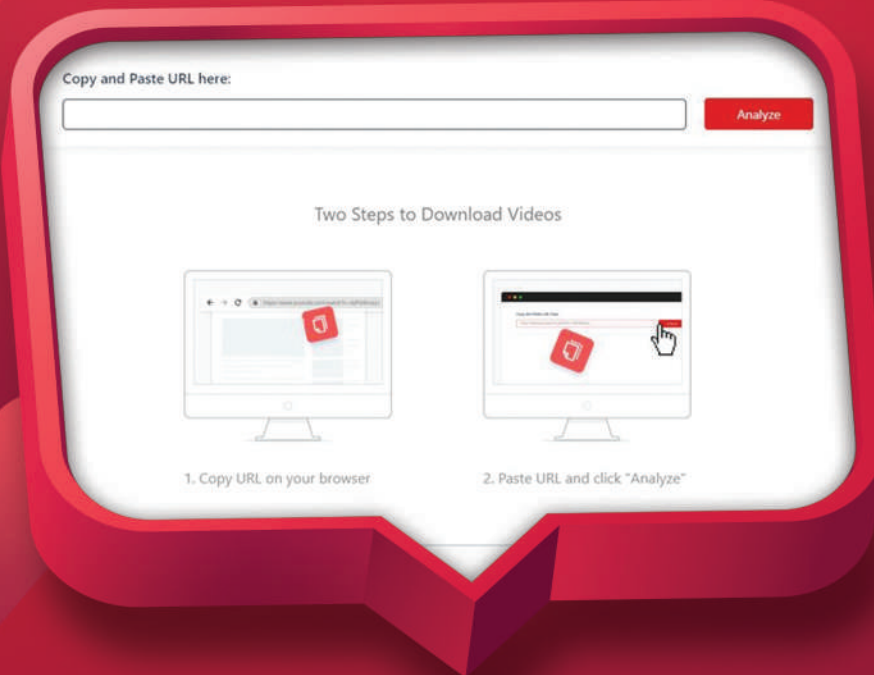

## Pros:

- Provide high-quality videos of up to 8K resolution
- Support download of subtitles
- Compatible with Windows and Mac OS
- Support download of playlists, channels
- Support batch download
- 6X faster download speed

## TOP 1. VideoHunter YouTube Downloader (Best)

**Supported Platforms: Windows, MacOS**

Your one-stop solution for downloading and converting high-quality YouTube video that's up to 8K is VideoHunter YouTube Downloader. Thanks to its many cutting-edge features, it is one of the most efficient products available today.

VideoHunter YouTube Downloader works flawlessly on all web browsers and is compatible with Mac and Windows operating systems.

## Cons:

- Only three free downloads per day.

## TOP 2. YTD Video Downloader (Windows Only)

**Supported Platforms: Windows**

YTD Video Downloader might not be the most potent free video downloader, but it allows you to download YouTube clips, full-length videos, or even movies on your device.

## TIPS & TRICKS

It also has some basic editing features that can meet your needs if you save videos to your local devices and utilize them as raw material for editing. You can keep your downloaded content high-quality, up to 4K forever. Sadly to mention is that it is only compatible with Windows right now!

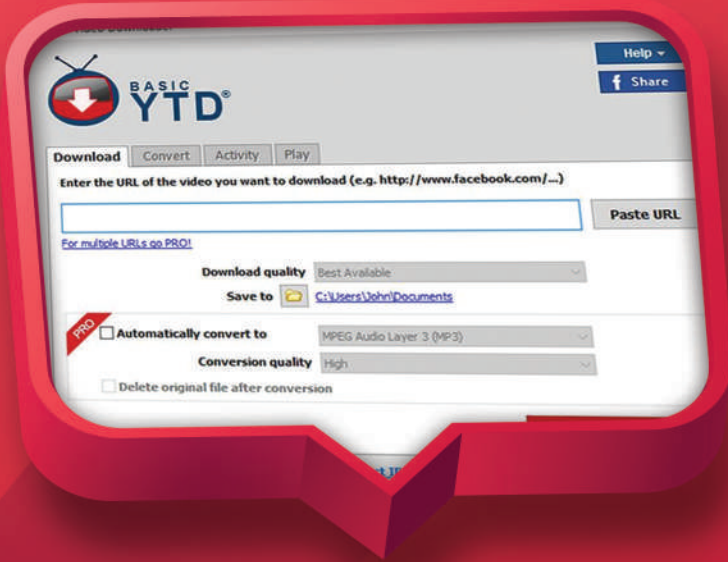

### Pros:

- Grab videos from multiple streaming platforms, including YouTube, Instagram, and Pinterest
- Preserve high-quality video up to 8k
- Provide simple editing tools

### Cons:

- Slow download speed
- Only download a video each time

## TOP 3. Any Video Converter Free

**Supported Platforms: Windows, MacOS**

Any Video Converter Free is a combination of video converter, compressor, clipper, and video cropper.

It allows you to easily download, convert, and edit videos. It can also convert YouTube videos into practically any format or resolution. Moreover, this YouTube downloader is compatible with Windows and MacOS operating systems.

It has bugs, though. Sometimes, the videos downloaded from the software appear with a blank screen, even though the interface indicates that the film is playing.



### Pros:

- Comprehensive free toolbox for video downloading, conversion, and editing
- User-friendly interface

### Cons:

- No batch downloads
- Bundled with extra software

## TOP 4. aTube Catcher (Windows Only)

**Supported Platforms: Windows**

As one of the existing video downloading programs, aTube Catcher also supports downloading YouTube videos.

## TIPS & TRICKS

It comes with an automated updater to ensure you are always running the most recent and working version of the program. You can choose an output quality of up to 4K to preserve video quality. In addition to downloading videos, other features include a screen recorder that lets you capture screen content and a CD-burning option to burn videos to discs. However, currently, the application is limited to Windows systems. Thus, Apple users may seek assistance from other tools such as VideoHunter.

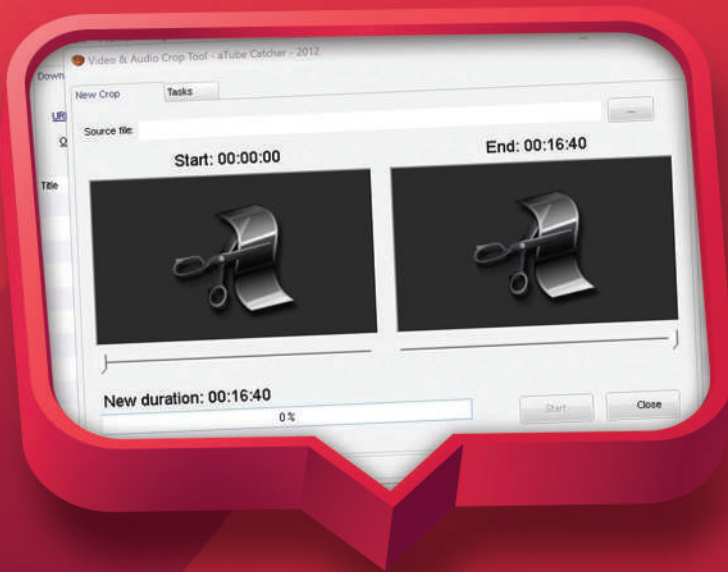

### Pros:

- Support various output format
- Update automatically
- Support download of videos from multiple streaming platforms

### Cons:

- Hard-to-use interface
- Bundled with extra software
- Only download a video each time
- Slow download speed

## TOP 5. ClipGrab (Windows Only)

### Supported Platforms: Windows

Another free video downloader that supports numerous streaming services, including Facebook, Vimeo, and YouTube, is ClipGrab. It has a built-in search engine that makes it simple and quick to locate the video to download without opening your browser. It also has a unique feature of clipboard monitoring when you intend to download a large number of videos. Additionally, it comes with a special feature that checks your clipboard.

ClipGrab will download a video automatically when you copy its link to the clipboard, sparing you the hassle of constantly switching between programs. The only video quality options available are 144p and 720p, sometimes insufficient if you seek higher output quality.



### Pros:

- Provide a built-in search function
- Automatically paste clipboard contents.

### Cons:

- Video output resolution only supports up to 720p
- Have a lot of ads
- Only download a video each time
- Slow download speed



## TOP 6. SaveFrom

### Supported Platforms: All

SaveFrom is an online video downloader that works with any device with an operating system. It allows you to download video clips from websites like YouTube and saves you the trouble of installing and opening any software. It provides multiple video output quality based on the original upload. You can save the video in the same resolution as the video owner has published.

Although there is no need to register, and the downloader is free to use, it does have many advertisements that may cause you problems. Please be aware that owing to copyright and legal concerns, SaveFrom has been no longer accessible in the United States since 2020.



#### Pros:

- Easy to use
- Support download of videos from multiple streaming platforms

#### Cons:

- Only download one video each time
- Have a lot of ads

### Final Verdict

A comparison table is provided to help you make clear the distinct features of the 6 products.

	Supported system	Download speed	Output quality
<b>VideoHunter YouTube Downloader</b>	Window, MacOS	6X faster	Up to 8K
<b>YTD Video Downloader</b>	Windows only	Slow	Up to 4K
<b>Any Video Converter Free</b>	Window, MacOS	1X	Up to 4K
<b>aTube Catcher</b>	Windows only	Slow	Up to 4K
<b>ClipGrab</b>	Windows only	Slow	Up to 720p
<b>SaveFrom</b>	As long as the device has an OS	1X	Up to 4K

EVENT NEWS

DATE EVENT VENUE TIMING CONTACT

2<sup>nd</sup> –  
3<sup>rd</sup> MAY

SUBSUR-  
FACE LIVE  
2024

Online

<https://dev.events/conferences/subsur-face-live-online-4-2024>

3<sup>rd</sup> MAY

Genera-  
tive AI Day  
2024

Sterlings  
Mac Hotel  
Bengaluru

09:30 PM –  
04:30 PM

<https://1point21gws.com/generative-ai/bangalore/nitesh@1point21gws.com>

10<sup>th</sup> MAY

Ignite your  
thoughts  
on AI/ML  
and IIoT  
2024

BS Abdur  
Rahman  
Crescent  
Institute of  
Science  
and Tech-  
nology,  
Chennai,  
Tamil  
Nadu

+91 91506 77763  
[industry4.ciic@crecident.education](mailto:industry4.ciic@crecident.education)

16<sup>th</sup> MAY

AWS

Sheraton  
Grand  
Bengaluru  
Whitefield  
Hotel &  
Conven-  
tion  
Center

10:00 AM –  
5:30 PM

Registration Link:  
<https://pages.awscloud.com/aws-summit-bengaluru-tech-edition-2024-reg.html?trk=634fd270-066a-46b2-aaf9-a8433dfe5392&trkcampaign=aws-summit>

# STUDENTS' CORNER



**Avijit Barman**  
B.Tech CSE (IoT), Semester II

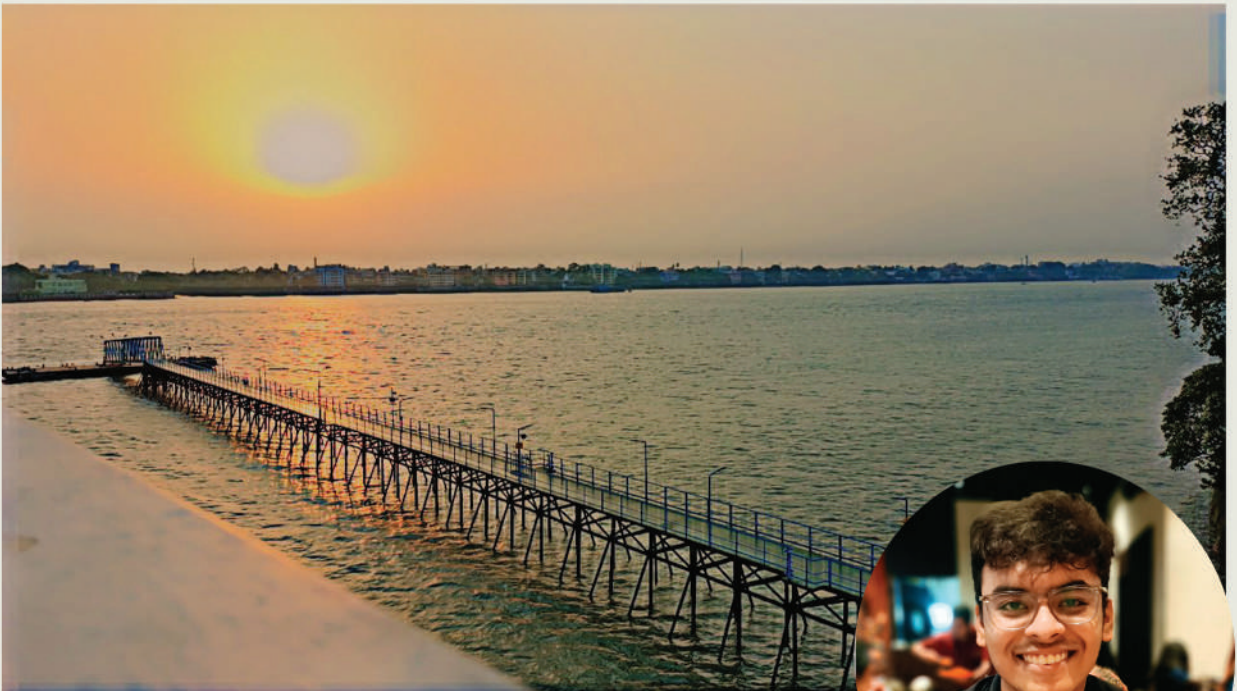

**Abhimanyu Ganguly**  
B.Tech EE, Semester II



## Electronics in Healthcare

~ Souhardya Ray – B.TECH (ECE), 1st Year

Engineering and medical science combine in the specialist field of medical electronics. It entails creating tools that can treat medical issues and enhance healthcare delivery.

The health team needs biomedical engineers because they use their understanding of biology and medicine to create novel medical gadgets. For example, they aid in creating prosthetic limbs and artificial organs.

Healthcare sector is gradually achieving digital integration at all steps of a patient's journey from lookout for symptomatic information, diagnosis, treatment and follow ups. Automation has embedded itself within various health care operations. The past two decades have seen the successful launch of various e-initiatives that've revolutionised most aspects of life, and their effects are being felt in the sphere of healthcare too. In fact, e-Health has immense potential to improve the quality and value of healthcare services delivery and, making available ample employment opportunities for engineering professionals globally.

Medical electronic devices also include in vitro diagnostic devices which help to carry out test samples like blood, tissue, and bodily fluids taken from the body. Examples of medical electronic devices are defibrillators, hearing aids, and diagnostic equipment for monitoring, recording, and measuring body functions like brain waves and heartbeat.

### Types of Medical Electronic Devices

There are different types of medical electronic devices. These devices help to treat health conditions within the human body.

#### Monitoring devices

Medical monitoring devices are widely used in various diagnostic and treatment procedures. Furthermore, they help to ensure these procedures are carefully and successfully carried out. Examples of medical monitoring devices include heart monitors, blood pressure monitors, EMG activity systems, flow rate and dispensing systems, X-ray computed tomography, and body temperature monitors.

## Medical diagnostic devices

These medical electronics are widely used in displaying, detecting, and acquiring medical images. Also, they provide vital information as regards the human body. Examples of medical diagnostic devices include magnetic resonance imaging (MRI), CT scanner, and ultrasound equipment. A CT scanner utilizes X-rays, special lenses, and computer algorithms to create images of the internal body parts of a patient. Ultrasound equipment generates sound waves that bounce off the human body. Also, this machine displays the picture of a structure and transforms it into an image.

## Implantable medical devices

Implantable devices help to replace defective organs in the human body. Also, they are directly implanted in the body of a patient. They serve as a substitute to any defective organ. Heart pacemakers, cochlear, and artificial kidneys are the most common implantable devices. Medical PCBs are a core part of these devices.

Medical electronics are majorly classified into three classes based on risks.

**Class I** medical devices are not designed for sustaining or supporting life and these devices may not have unreasonable injury risk. More than 47% of medical devices available on the market are Class I. Also, Class I devices are subject to few restrictions and regulatory requirements. However, these devices need to adhere to some general regulations like branding, adulteration, and device registration.

**Class II** medical devices has a higher risk than Class I. Also, controls differ based on the device when it comes to class II devices. However, post-market surveillance, special labeling requirements, and device performance are examples of common controls.

**Class III** devices are medical devices that support or sustain life. Also, they are usually implanted and have possible unreasonable risk of injury or illness. Therefore, these devices are highly regulated. Class III devices are usually reserved for cutting edge medical purposes. Also, Class III devices have the highest risk.

Medical electronics require high reliability and high performance printed circuit boards to function. Also, it is crucial to integrate high quality board in the manufacturing of medical electronics since these devices are mainly used for life saving purpose. With recent advancement in technology, diagnostic, research, and treatment strategies are also becoming automated. Therefore, PCBs have a great role in the production of medical electronics.

Implantable devices, diagnostic devices, and monitoring devices comprise printed circuit boards.

A medical PCB integrates electronic components. Also, this PCB offers electrical connection and mechanical support to electronic components in medical devices. This PCB encompasses the electronic components and as such, these medical devices are safe for humans. These boards are majorly designed to function in varying temperatures from  $-40^{\circ}\text{C}$  to  $140^{\circ}\text{C}$ . Also, the medical use of PCBs keeps growing as electronics advance to be better and more efficient. The increasing demand for new medical equipment has resulted in more dependency on more recent technologies like rigid-flex PCBs.

## Application of Electronics in the Medical Field

### Brain wave machine

Brain wave machine is a crucial medical electronics used in recording the scalp's electrical activity. It works by discharging neurons within the brain. Also, this machine processes the data acquired from the electrodes which are then positioned on the scalp. The brain wave machine has a screen in which it displays results. Also, this machine helps in treating brain disorders like brain death, mental unhealthiness, and sleeping disorder.

### Defibrillator

Defibrillator is very crucial in emergency situations. It is mostly used in emergency conditions such as heart attack. Also, this medical electronic device affects the heart rhythm like pulseless ventricular tachycardia, ventricular fibrillation, and cardiac arrhythmia. The defibrillator works by delivering electric shock to the heart. This then causes the heart muscles to depolarize and reproduces normal conduction of the heart's electrical pulse.

### Magnetic Resonance Imaging (MRI)

The MRI machine reviews the inner elements of the human body. This machine is widely used in radiology. Also, MRI machine work by using a strong magnetic field to create images of the body. MRI machines are diagnostic devices which have effect on identifying and treating several specialties. Also, MRI doesn't integrate radiation. Therefore, it is highly preferred to CT scanner.

### Blood gas analyser

The blood gas analyzer is the best application of electronics in the medical industry. It calculates the pressure of chemical substances like oxygen and carbon monoxide in blood. Health care providers can detect any disorder in blood by analyzing results. This machine has a chemical device strip in which it collects blood. The chemical device strip features particle selective electrodes.

### Electronic cardiac monitor

This medical electronic device helps to display the cardiac system's pressure waveforms. Health care providers insert specific electrodes on the body to obtain ECG of the cardiac system. Also, this monitor checks for any irregular activity in the cardiac system. It is widely used in medical treatment, especially during surgery.

### **Digitalization**

Digitalization is changing how medicine is developed and made available to patients in the medical sector. It improves productivity and lowers expenses by assisting medical professionals in reaching diagnostic and treatment decisions more quickly. The capacity to store and access data from anywhere at any time is only one of its many benefits.

Computational simulation is a crucial aspect of digitalization to determine device performance and durability for medical devices. For instance, finite element analysis (FEA) enables designers to model potential failure scenarios for medical devices.

Medical electronics engineers must also consider legal regulations, manufacturing certifications, validation standards, and concerns associated with obsolescence for obsolete or old components. This is particularly true given the increased desire for compact, sophisticated, connected devices that can meet various regulatory requirements and hit the market fast on the part of medical OEMs.

### **3D Bioprinting**

There are several uses for 3D bioprinting, such as disease modeling and drug screening. However, the most exciting is the use of 3D-manufactured organs for transplantation.

Patients may be able to print their organs using their cells or stem cells, doing away with the necessity for organ donors. Although printing an entire organ sounds far-fetched, developments are occurring quickly. For instance, scientists at Tel Aviv University have successfully built a 3D heart from a patient's biological components.

### **Robotics**

We can use robots for many jobs, from moving hazardous products to providing medical treatment. For example, hospitals and clinics employ them to assist medical professionals in completing activities without jeopardizing their safety and effectiveness.

Also, these robots are employed more frequently to reduce surgical human error. They can execute precise movements and take over low-level duties while the surgeon concentrates on high-level work.

Robotics training for surgeons is another usage for them. Doctors can rehearse treatments and enhance their skills using robotic controls on simulation platforms that combine AI and VR.

Safety, quality, and efficiency are crucial elements determining how robotics will develop in healthcare.

## Artificial Intelligence (AI)

A technology called artificial intelligence enables computers to learn and analyze data. AI assists medical professionals in the diagnosis and better monitoring and treatment of patients' conditions. Also, it minimizes the necessity for invasive treatments and improves specialists' decision-making.

Before they are essential in clinics and hospitals, AI solutions must overcome numerous obstacles. They include ensuring these technologies are reliable, efficient, and morally upright.

The usage of AI technology will also require training for healthcare personnel. These professionals will require the ability to evaluate data, apply it efficiently, and comprehend human-machine interaction.

## Conclusion

Medical electronics play a crucial role in the medical industry. Also, these electronics have contributed to the development of the medical industry. Designing and producing medical devices isn't a straightforward process. One major concern is reducing time-to-market. Also, medical electronics are specifically designed for life-saving purposes. Therefore manufacturers should pay attention to important details during medical device design and production.



# Brain Gym

## TECHNICHÉ

Welcome to the Brain Gym, where we put your grey matter through its paces with mind-bending puzzles, coding conundrums, and a generous dose of geek humor. Get ready to flex those neural networks and have a laugh or two along the way!

### Tech Riddles

1. I am all about places, yet I am hard to find. In a project, you always track my changes. What am I?
2. I can be cracked, made, told, and played. What am I?
3. The more you take of me, the more you leave behind. What am I?

### Code Cracker

Can you decipher this cryptic code snippet?

Copy code

```
1 int[] arr = {1, 2, 3, 4, 5};
2 int sum = 0;
3 for (int i = 0; i < arr.Length; i++) {
4     if (arr[i] % 2 == 0) {
5         sum += arr[i];
6     }
7 }
8 Console.WriteLine(sum);
9
```

What will be the output? Hint: It's an even-numbered sum.

### Logic Labyrinth

A software company has three employees: Max, Bob, and Charlie. They were asked, "Do you know how to code in Python?" Here are their responses:

Max: "At least one of us knows Python." Bob: "Exactly two of us know Python." Charlie: "None of us knows Python."

If only one person is telling the truth, who knows how to code in Python?

## Pun-derful Coding

**Q:** Why did the database administrator leave their partner?

**A:** They had too many conflicting values.

**Q:** Why did the developer go broke?

**A:** Because they used up all their cache.

**Q:** Why did the developer refuse to work on the construction site?

**A:** They didn't get concrete results.

## Brain Teasers

1. If you have a bucket that holds 5 liters and a bucket that holds 8 liters, how can you measure out exactly 7 liters of water?

2. A man wants to cross a river with a wolf, a goat, and a cabbage. He can only carry one thing across the river at a time, and if he leaves the wolf and the goat alone, the wolf will eat the goat. If he leaves the goat and the cabbage alone, the goat will eat the cabbage. How can he get all three across the river safely?

Solutions will be published in the next issue, so stay tuned and keep those gears turning!



**nature**  
innovate

**BUILD YOUR PLAYLIST**  
WITH  
NatureInnovate's

**TWS**



**LONG HOURS OF PLAYTIME....**

