

User Manual



On behalf of the entire Ori team, I'd like to welcome you to the growing Ori family – we are so excited you've chosen to live with Ori, and given us the opportunity to be a part of your life. We started Ori to improve the lives of people by helping them make better use of their living spaces. We believe that these spaces should respond to our needs and adapt to our everyday lives. And in a world of rising real estate prices and shrinking living spaces, we want to help people live large in a smaller (and smarter) footprint. That vision guides us every day.

This User Manual will introduce you to your Ori, and show you how you can find everything you need to make the most of living with Ori. Please know that the entire Ori team is ready to help, so never hesitate to reach out. We want to help you live the life you want, where you want to live it – so let's get started!



Hasier Larrea

Founder & CEO

ceo@oriliving.com

we
come
to
live

Product Overview

01

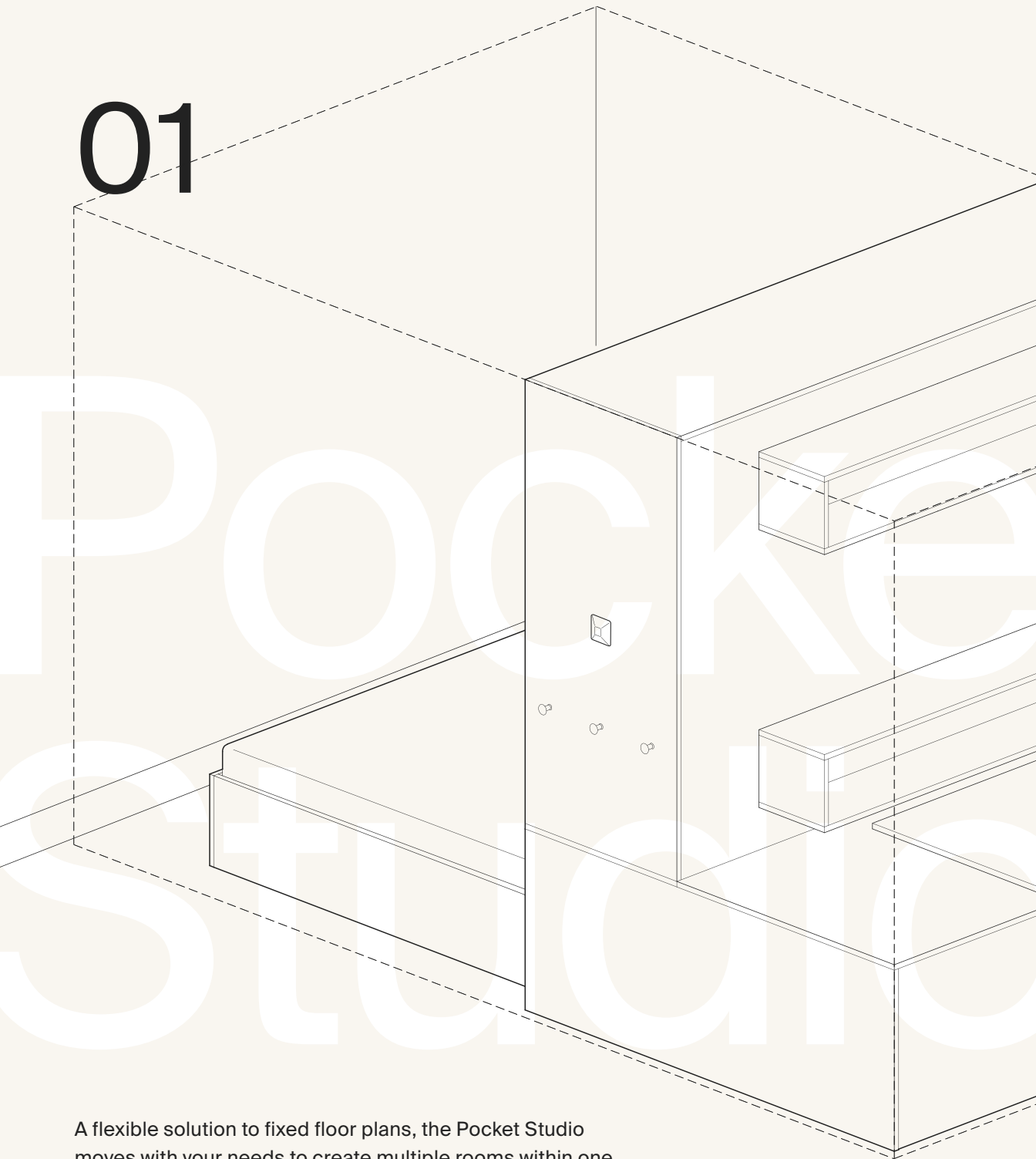

A flexible solution to fixed floor plans, the Pocket Studio moves with your needs to create multiple rooms within one space. From bedroom to private office to living room to walk-in closet, the right space is revealed when you need it.

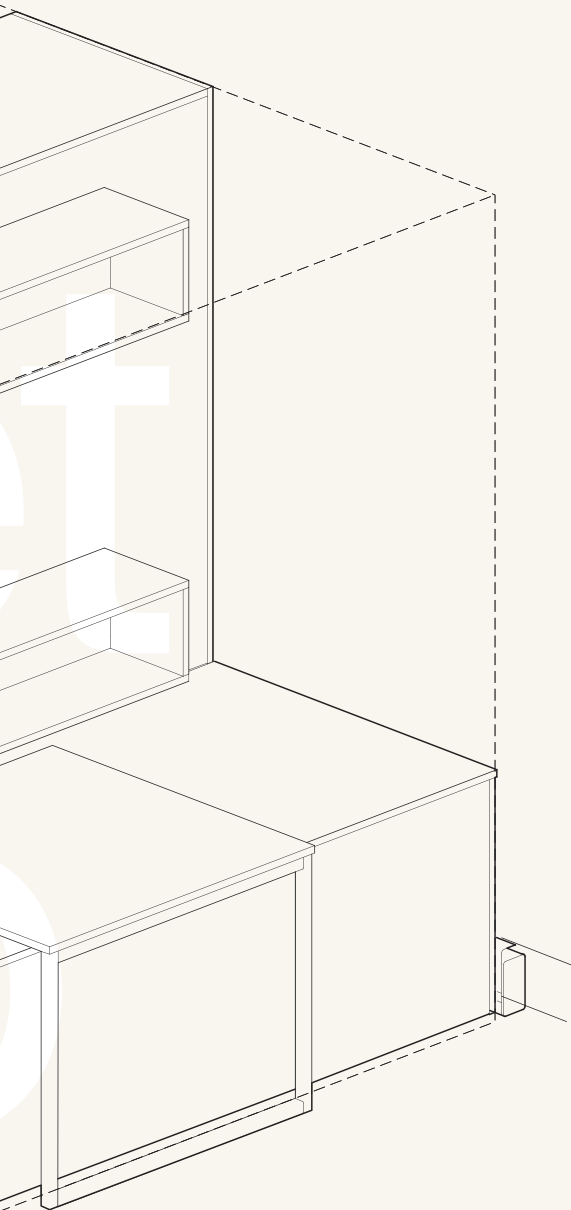

BED SIZE

Queen or Full

TRANSITION TIME

30 sec

MAX MEDIA SIZE

60" TV

BEDROOM ALCOVE

Easily create a private alcove with a comfortable, built-in queen or full-size bed.

SPACIOUS CLOSET

Enjoy double the storage of a standard apartment and cut down on clutter.

PULL-OUT TABLE

Create room for your workday or a dinner party with the multipurpose, pull-out table.

MEDIA CENTER

Showcase on the built-in display, with space for books, plants, treasures, and a 60" TV.

LED LIGHTING

Bask in the warm, ambient glow of embedded LED lights that beautifully accentuate the space and create a customizable atmosphere

The Ori Square

02

Effortless Transformation



ACTIVATE THE SQUARE

Tap the Ori logo to wake the Ori Square. You will see various icons light up.



CREATE A ROOM

Tap the icons on the bottom of the Square to create a bedroom, living room, or closet.

ADJUST THE LIGHTS

Tap the  icon to turn Ori's lights on or off. Tap  or  to adjust the brightness.

ADJUST SYSTEM POSITION

Press and hold the arrows   on either side to adjust the system's position as needed.



ORI SQUARE
TUTORIAL

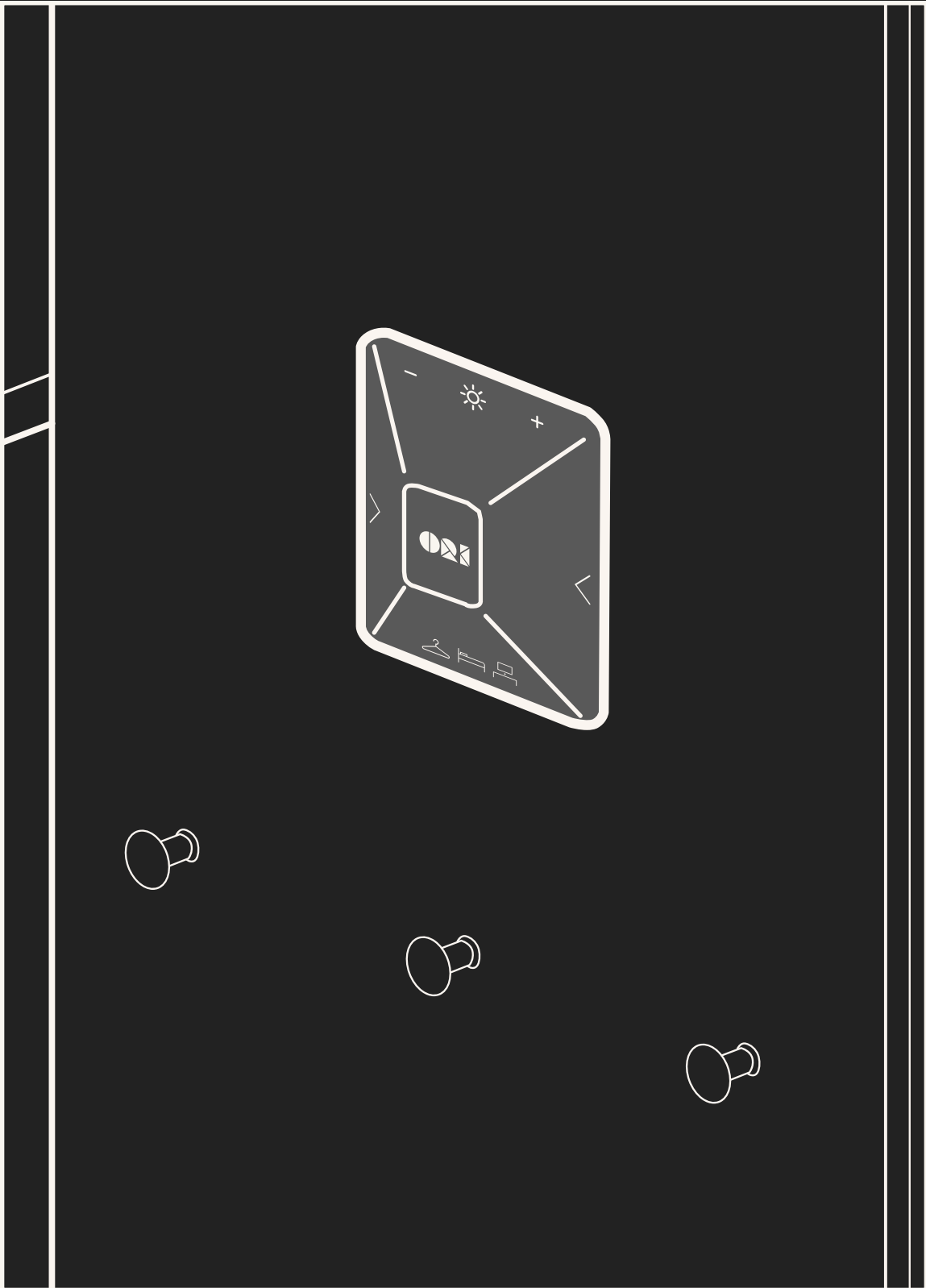

Customization & Control

03

REMOTE CONTROL APP

Download Ori App

Use the QR codes below to download the app to your phone.



Create Your Ori Account

Click “sign up” on the home screen to create your Ori account.

Connect Your System to WiFi

Follow on-screen instructions to connect to your system via WiFi.

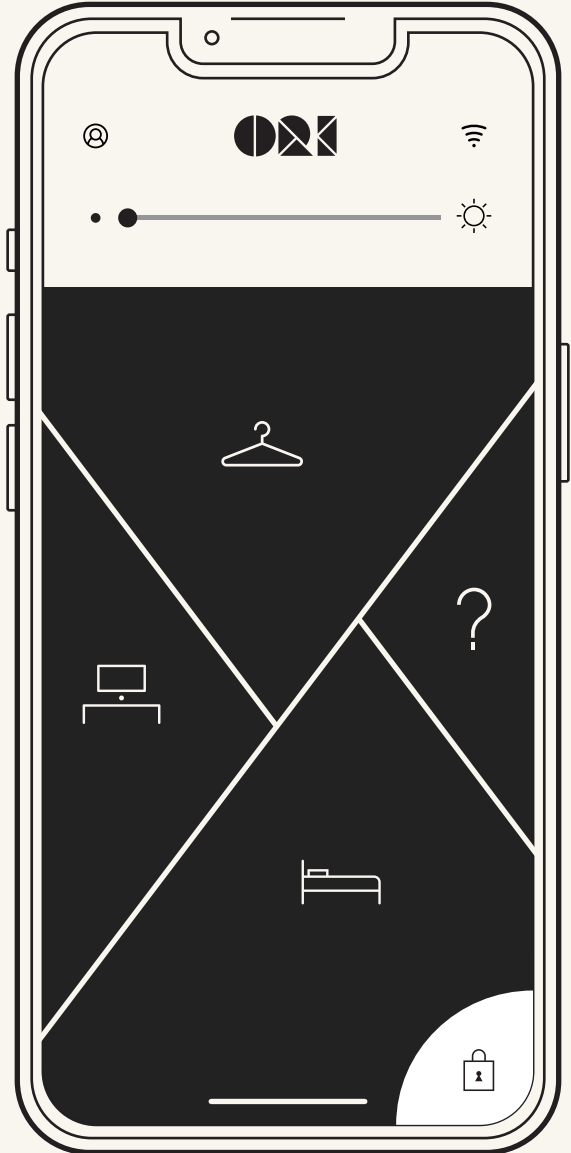

USER PORTAL

Ori's User Portal is a one-stop-shop, helping you complete your Ori setup with voice control and lock mode, routing you to our Service Portal, and giving you the opportunity to provide feedback and earn cash.

Visit user.oriliving.com for more.



USER PORTAL

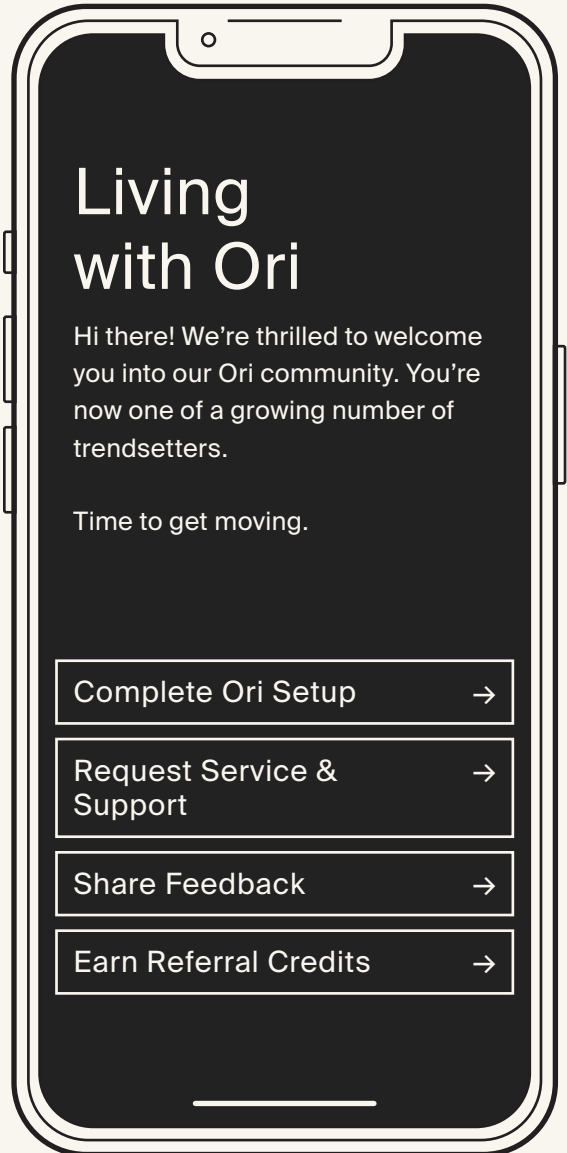

Troubleshooting & Support

04

Need help?

Ori systems are tested rigorously, so we don't expect any problems. In the unlikely event of one, our Service Portal gets you help fast. From movement issues to damage, we've got you covered.

Visit service.oriliving.com
for more.



SERVICE PORTAL

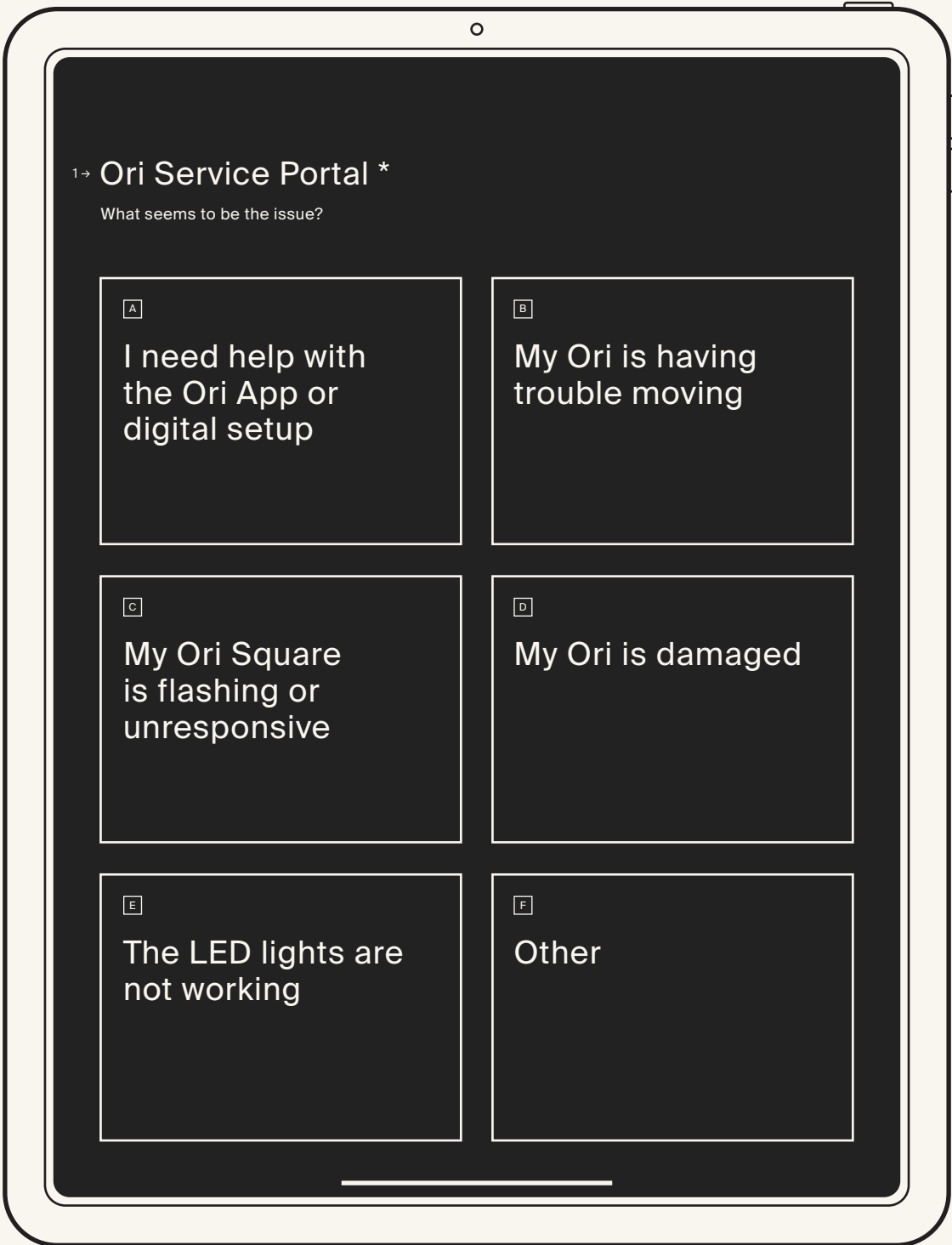

1→ Ori Service Portal *

What seems to be the issue?

A

I need help with the Ori App or digital setup

B

My Ori is having trouble moving

C

My Ori Square is flashing or unresponsive

D

My Ori is damaged

E

The LED lights are not working

F

Other

User Tips & Tricks

05

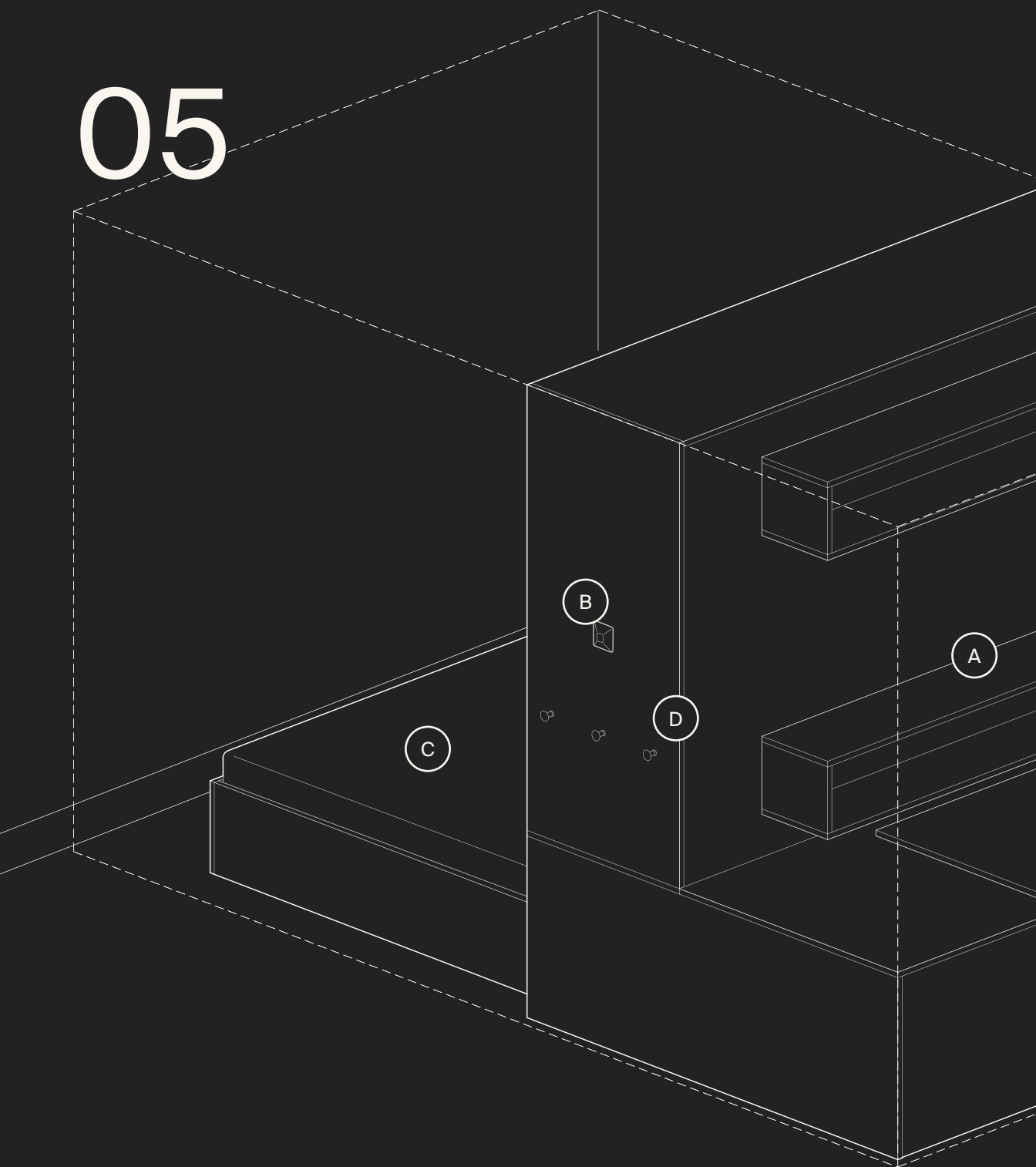

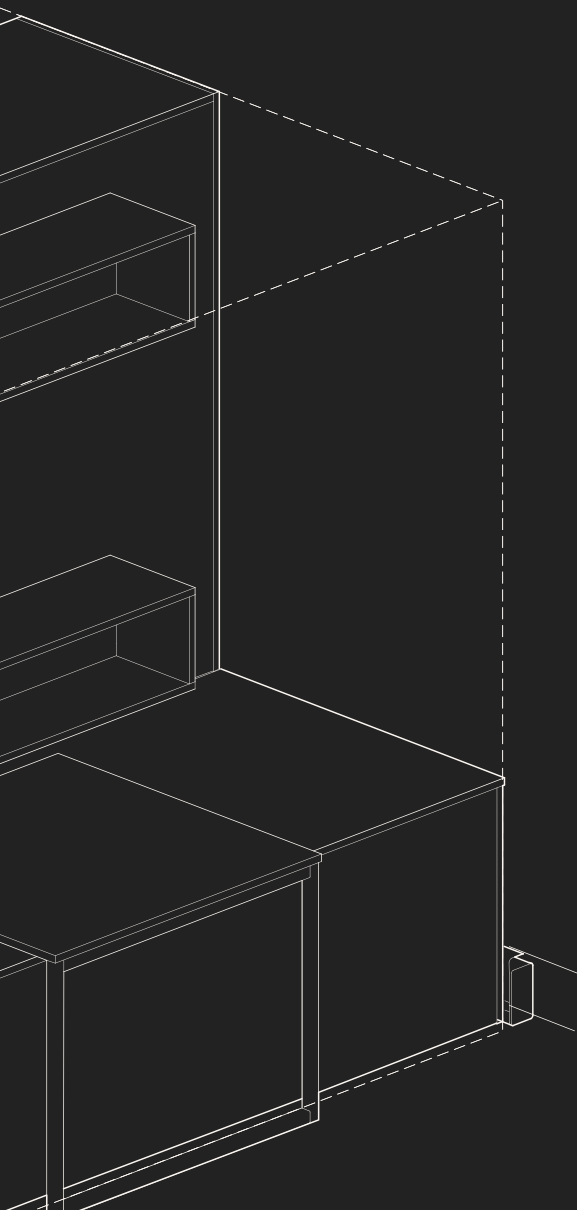

A. ADJUSTING FOR A LARGER TV

The Pocket Studio shelves can be adjusted to fit a larger TV. Please visit the Ori Service Portal for assistance.

B. ADJUSTING PRESET POSITIONS

The Ori Pocket Studio's preset positions can be adjusted or reset if necessary (for example, upon move-in or after a power outage). Please visit the Ori Service Portal for guidance.

C. MATTRESS GUIDANCE

The Pocket Studio can accommodate a variety of mattress types, ensuring you get your best night's sleep. Just keep the following guidelines in mind when selecting a mattress for your space.

- Maximum mattress weight: 160lb
- Maximum mattress height: 10"
(10" leaves clearance for pillows to stay on bed)
- Maximum load on bed: 600lb

D. MOVEMENT IN A POWER OUTAGE

If the power ever goes out, fear not. You can easily move your Pocket Studio manually. It may be helpful to grab a shelf or hanging knob when pulling the system.

If you ever need to move your system manually for a different reason, just make sure to unplug it first. Doing so disengages the motor and enables manual movement.

Safety

06

MAX LOADS/ POCKET STUDIO LITE

System Max: 445 lbs.

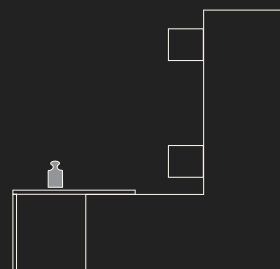
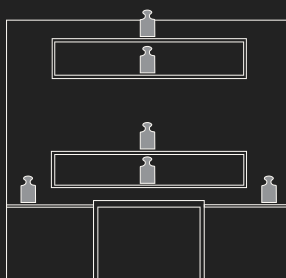
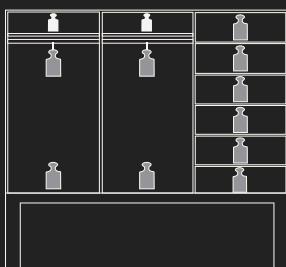

KEY

50 lbs. 

25 lbs. 

10 lbs. 

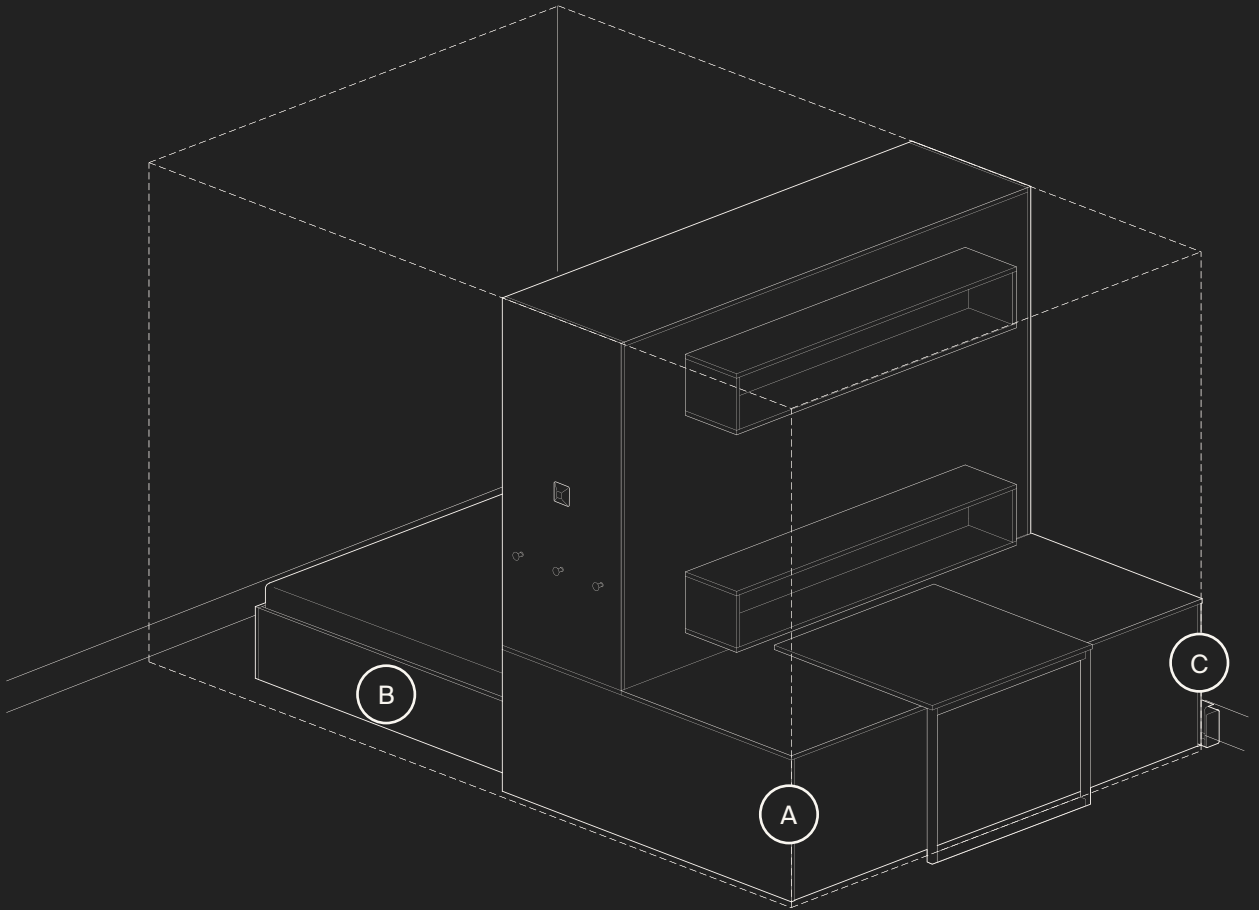

A. SAFETY-STOP

Ori comes equipped with an auto-stop feature, which automatically halts and retracts the system when it encounters an obstacle, such as a person, pet, or object. All it takes is the force of two fingers to halt any movement.

B. STABILITY FEET

The Pocket Studio's bed frame has adjustable feet that make contact with the floor when someone lies down to increase stability. At times, the feet may not be properly adjusted and will not make full contact or will rub against the floor. This misalignment can occur when new weight is added to the bed, such as a new mattress. Please check these feet if your Pocket Studio ever has trouble moving.

C. OVER CURRENT PROTECTION

If too many devices that are plugged into the Pocket Studio's outlets are in use at the same time, the system's over current protection will trigger, cutting the power. If this occurs, switch off all the plugged-in devices, reset the power by pressing the red button at the end of the guidance track, and then resume use of a fewer number of devices.

Input Voltage: 125Vac
 Input Frequency: 50/60 Hz
 Operating Power; moving: 40W
 Max Power; lights: 60W
 Max Power per power strip: 1320W
 Max Linear Speed: 4inch/s = 100mm/s

Do NOT plug vacuum cleaners or hair dryers into any outlet on your Ori system.

Safety Notices

Household/Residential Use Only - only operate on hard surfaces. Read all instructions before using the Pocket Studio. When using an electrical furnishing, basic precautions should always be followed, including the following:

DANGER - To reduce the risk of electric shock: Always unplug this furnishing from the electrical outlet before cleaning.

WARNING - To reduce the risk of fire, electric shock, or injury to persons:

1. Unplug from the outlet before putting on or taking off parts.
2. Close supervision is necessary when this furnishing is used by, or near children, invalids, disabled persons, or pets.
3. Use this furnishing only for its intended use as described in these instructions. Do not use attachments not recommended by the manufacturer.
4. Never operate this furnishing if it has a damaged cord or plug, if it is not working properly, if it has been dropped or damaged, or come into contact with water. Contact Ori Support for examination and repair.
5. Keep the cord away from heated surfaces.
6. Never operate the furnishing with the air openings blocked. Keep the air openings free of lint, hair, and the like.
7. Never drop or insert any object into any opening.
8. Do not use outdoors.
9. Do not operate where aerosol (spray) products are being used or where oxygen is being administered.
10. To disconnect, remove plug from outlet.

WARNING - Risk of Injury - Keep children away from the bed before operating. When this furnishing is in motion provide supervision and make sure that all objects, persons, and pets are free from its path.

WARNING - Risk of Electric

Shock - Connect this furnishing to a properly grounded outlet only. See grounding instructions.

WARNING - Risk of death or serious injury may occur when children climb on the furnishing. A remote control or toys placed on the furnishing may encourage a child to climb on the furnishing and as a result the furnishing may tip over on to the child.

WARNING - Risk of death or serious injury may occur due to the furnishing collapsing or over turning onto a child when relocating audio and/ or video equipment to furniture not specifically designed to support audio and/or video equipment.

WARNING - If the unit is installed within 6' of a sink, it must be plugged to a brach circuit provided with Class A GFCI protection.

GROUNDING INSTRUCTIONS

This product is for use on a nominal 120-volt circuit and has a grounding plug that looks like the plug illustrated in sketch A (see next Figure). Make sure that the product is connected to an outlet having the same configuration as the plug. No adapter should be used with this product.

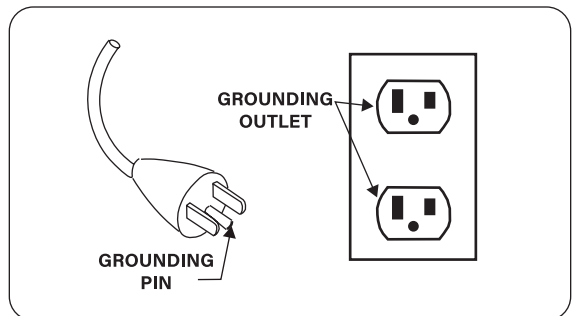

SAVE THESE INSTRUCTIONS



DOC-PL-0002 Rev C
Ori, Inc.
12 Channel St, Suite 202
Boston, MA 02210
www.oriliving.com