

Cloud Bed  
Desk Edition

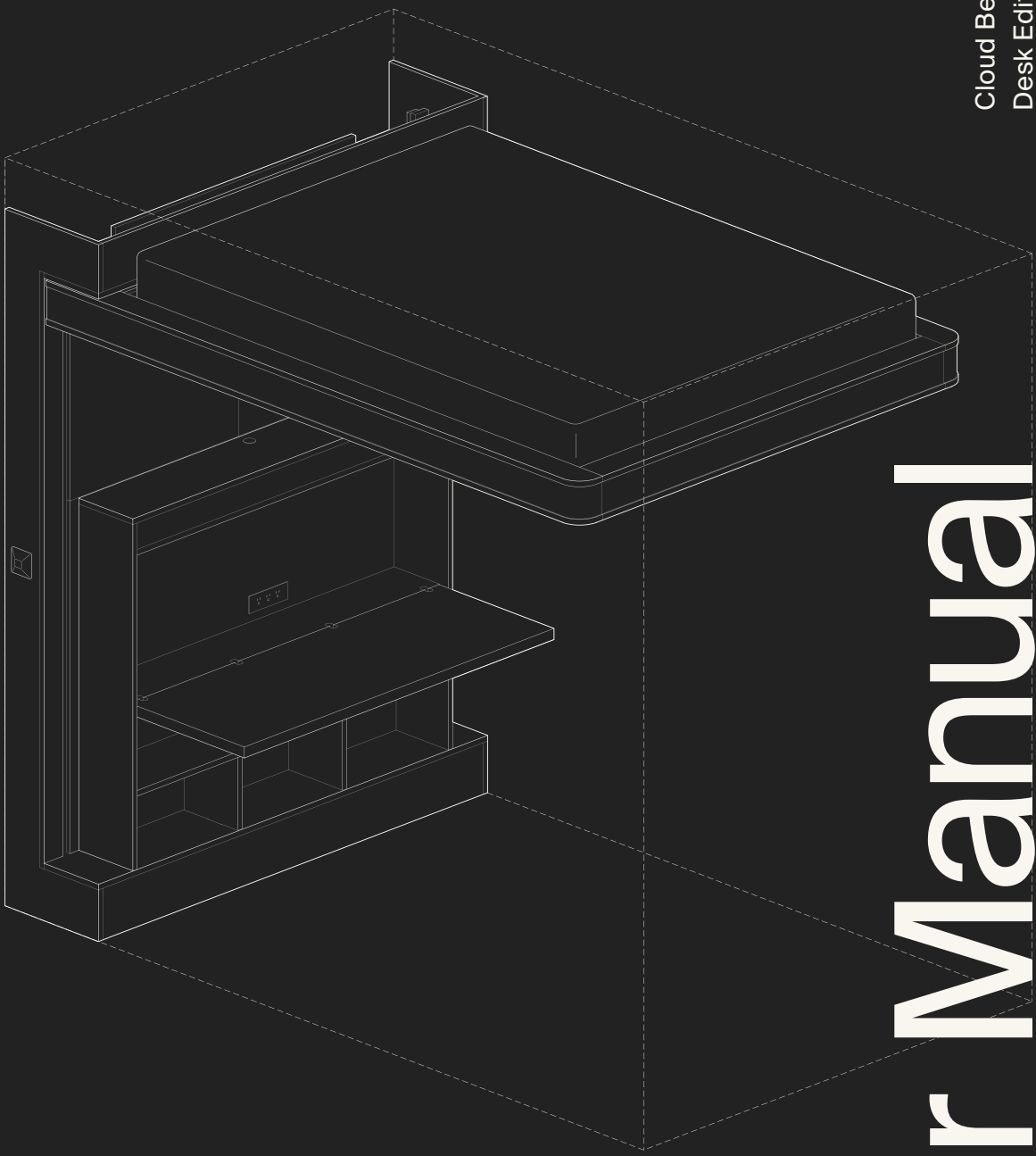

# User Manual





On behalf of the entire Ori team, I'd like to welcome you to the growing Ori family – we are so excited you've chosen to live with Ori, and given us the opportunity to be a part of your life. We started Ori to improve the lives of people by helping them make better use of their living spaces. We believe that these spaces should respond to our needs and adapt to our everyday lives. And in a world of rising real estate prices and shrinking living spaces, we want to help people live large in a smaller (and smarter) footprint. That vision guides us every day.

This User Manual will introduce you to your Ori, and show you how you can find everything you need to make the most of living with Ori. Please know that the entire Ori team is ready to help, so never hesitate to reach out. We want to help you live the life you want, where you want to live it – so let's get started!



**Hasier Larrea**

Founder & CEO

[ceo@oriliving.com](mailto:ceo@oriliving.com)



# Product Overview

# 01

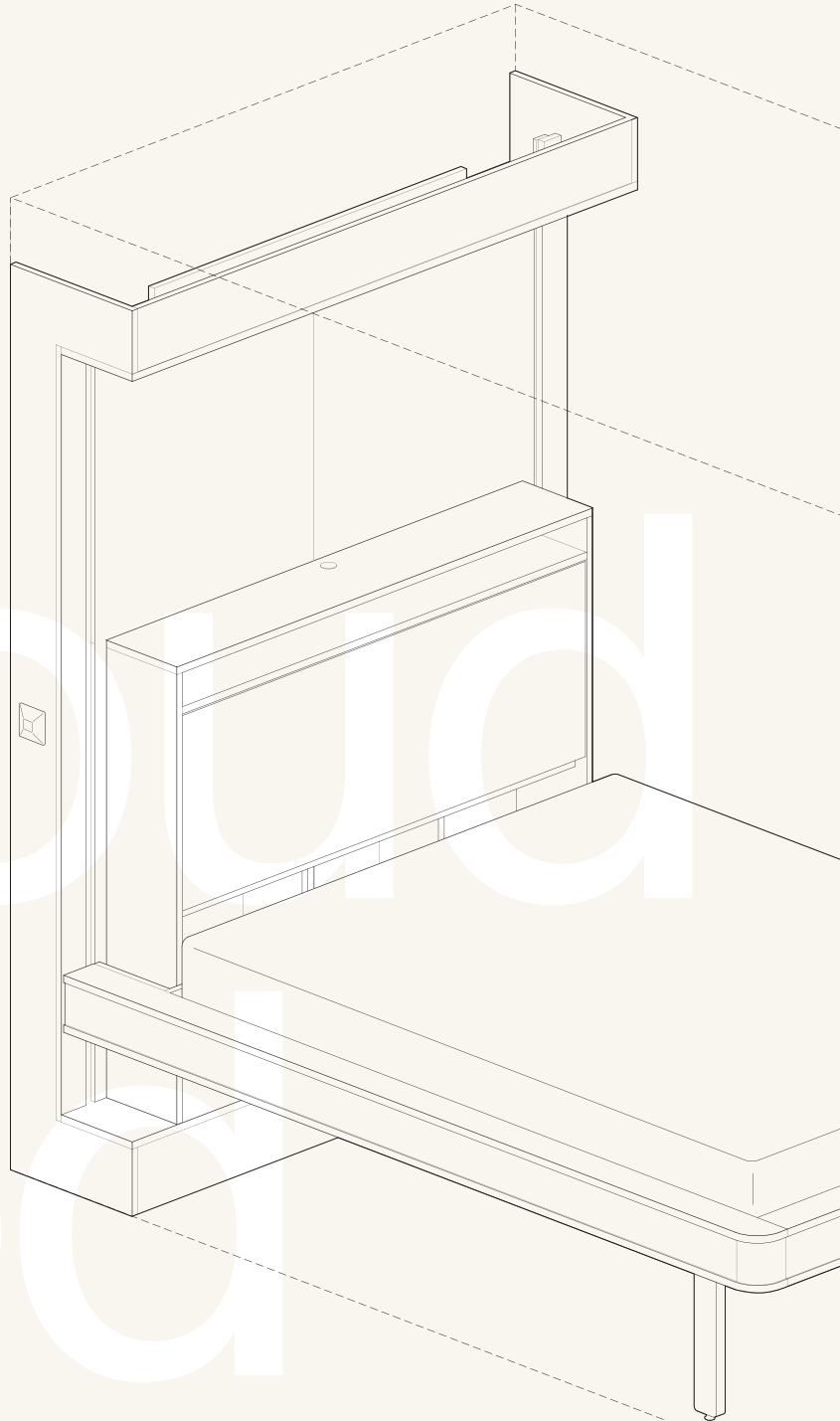

An effortless way to transform space and create two rooms within one, the Ori Cloud Bed disappears into the ceiling to reveal a practical and productive work space, complete with built-in desk and storage.

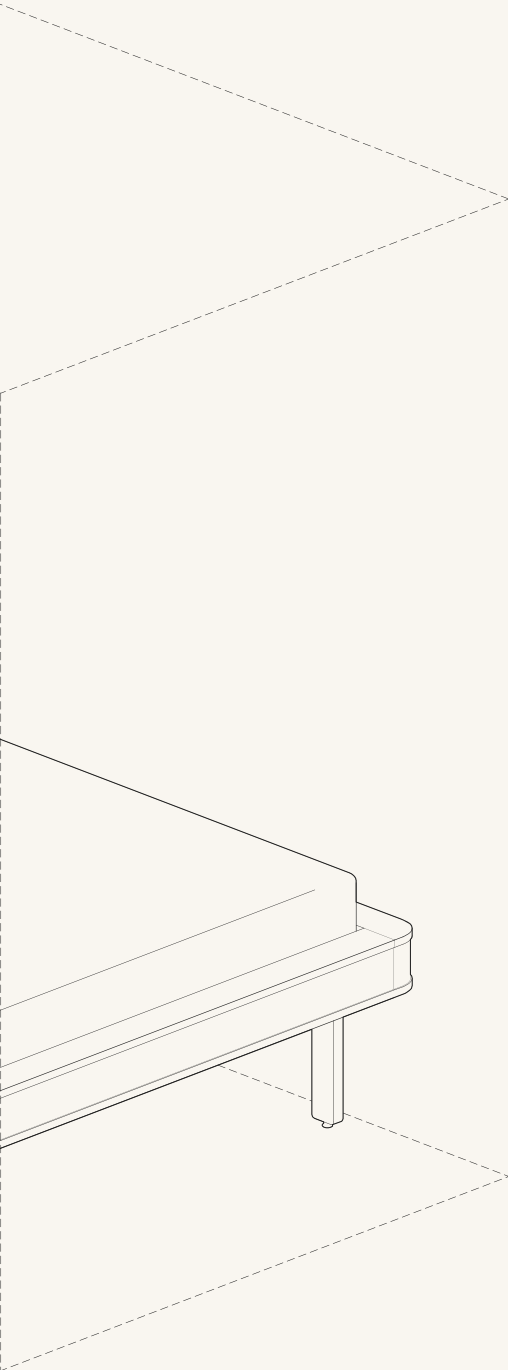

BED SIZE

**Queen**

TRANSITION TIME

**30 sec**

MONITOR CAPACITY

**2 Monitors**

DISAPPEARING BED

Enjoy the luxury of a Queen bed, without losing an inch of living space.

BUILT-IN EXECUTIVE DESK

Spread out along the 2-foot deep and 4 1/2-foot wide executive desk, with room for two monitors, plenty of paperwork, a keyboard, a mouse, and much more.

FUNCTIONAL WORKSPACE

Ample shelves and outlets make the Cloud Bed Desk a highly functional workspace, storing cords, files, and ideas comfortably out of site.

LED LIGHTING

Bask in the warm, ambient glow of hidden LED lights that beautifully accentuate the product and the space, creating a customizable atmosphere for any circumstance.

# The Ori Square

## 02

### Effortless Transformation

#### ACTIVATE THE SQUARE

---

Tap the Ori logo to wake the Ori Square.  
You will see various icons light up.



#### CREATE A ROOM

---

Tap the  icon on the bottom of the Square to hide or reveal your bed(room).

#### ADJUST THE LIGHTS

---

Tap the  icon to turn Ori's lights on or off.  
Tap  or  to adjust the brightness.



ORI SQUARE  
TUTORIAL

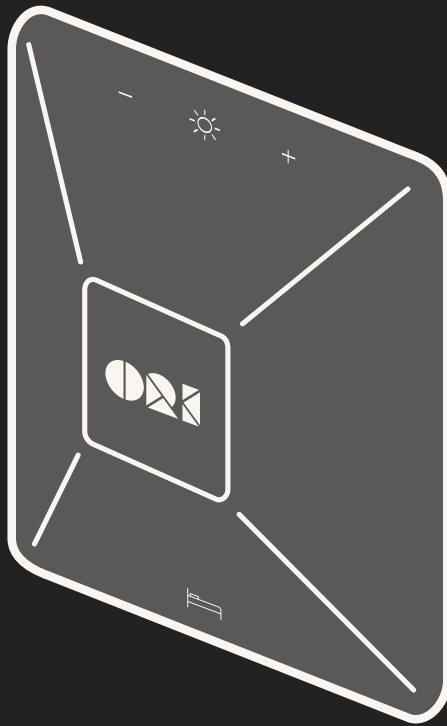

# Customization & Control

## 03

### REMOTE CONTROL APP

---

#### Download Ori App

Use the QR codes below to download the app to your phone.



#### Create Your Ori Account

Click “sign up” on the home screen to create your Ori account.

#### Connect Your System to WiFi

Follow on-screen instructions to connect to your system via WiFi.

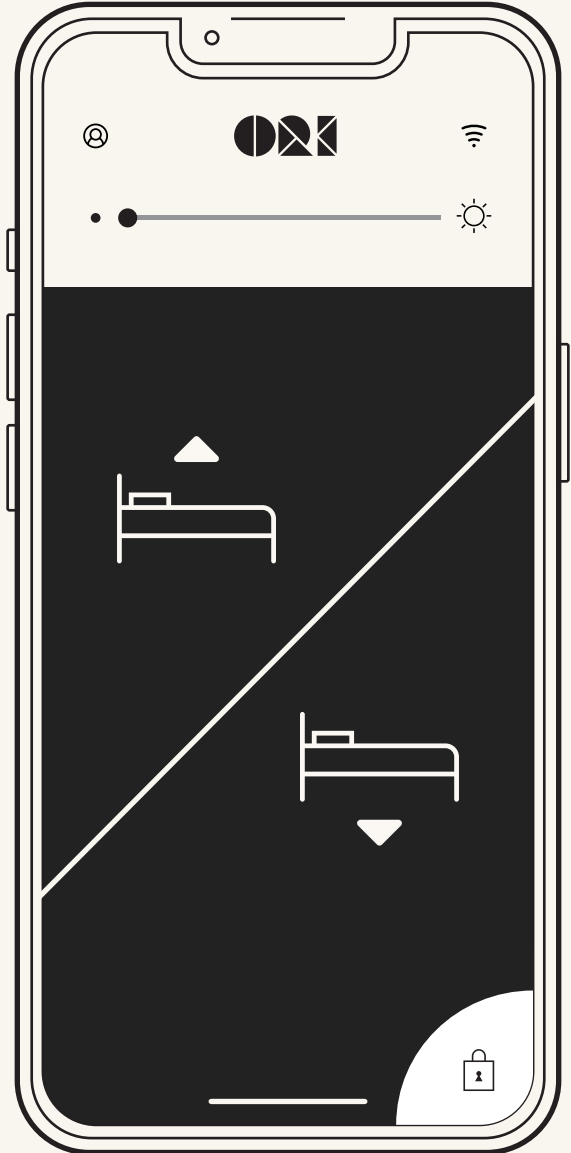



USER PORTAL

Ori's User Portal is a one-stop-shop, helping you complete your Ori setup with voice control and lock mode, routing you to our Service Portal, and giving you the opportunity to provide feedback and earn cash.

Visit [user.oriliving.com](https://user.oriliving.com) for more.



USER PORTAL

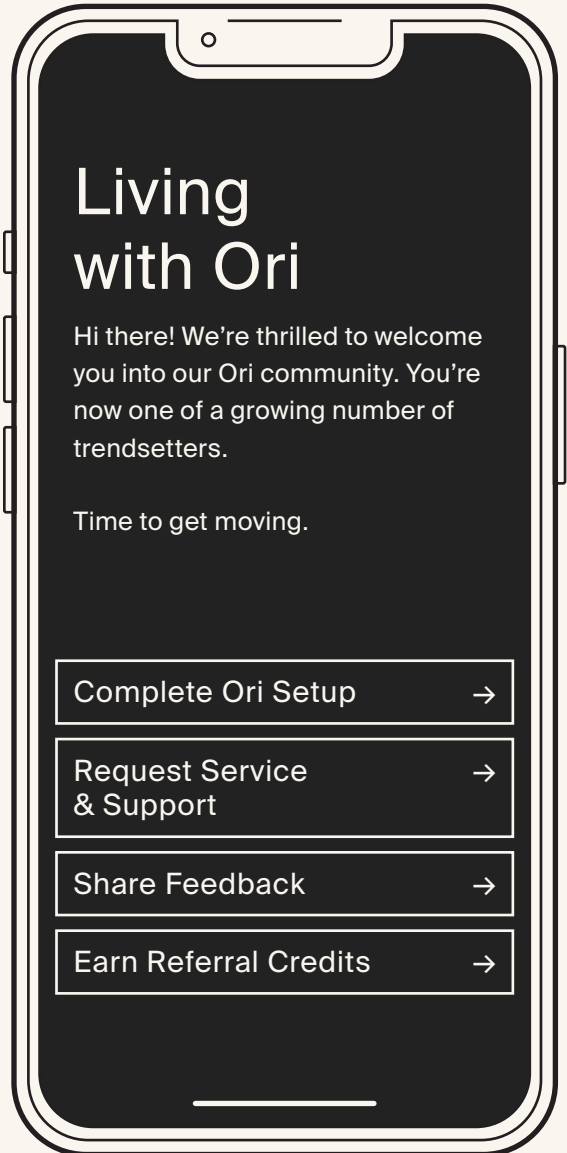

# Troubleshooting & Support

## 04

### Need help?

Ori systems are tested rigorously, so we don't expect any problems. In the unlikely event of one, our Service Portal gets you help fast. From movement issues to damage, we've got you covered.

Visit [service.oriliving.com](https://service.oriliving.com)  
for more.



SERVICE PORTAL

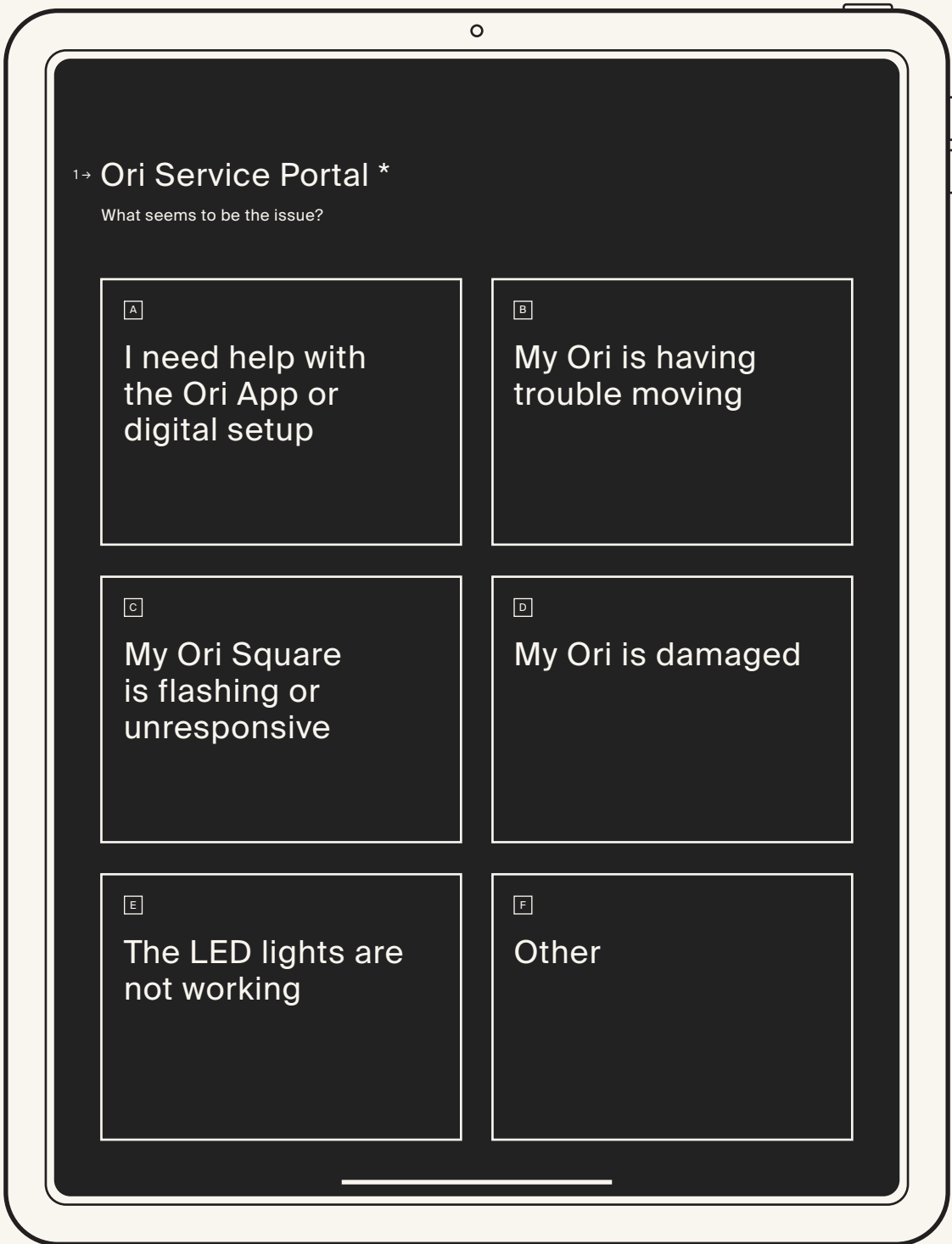

1→ Ori Service Portal \*

What seems to be the issue?

A

I need help with the Ori App or digital setup

B

My Ori is having trouble moving

C

My Ori Square is flashing or unresponsive

D

My Ori is damaged

E

The LED lights are not working

F

Other

# User Tips & Tricks

## 05

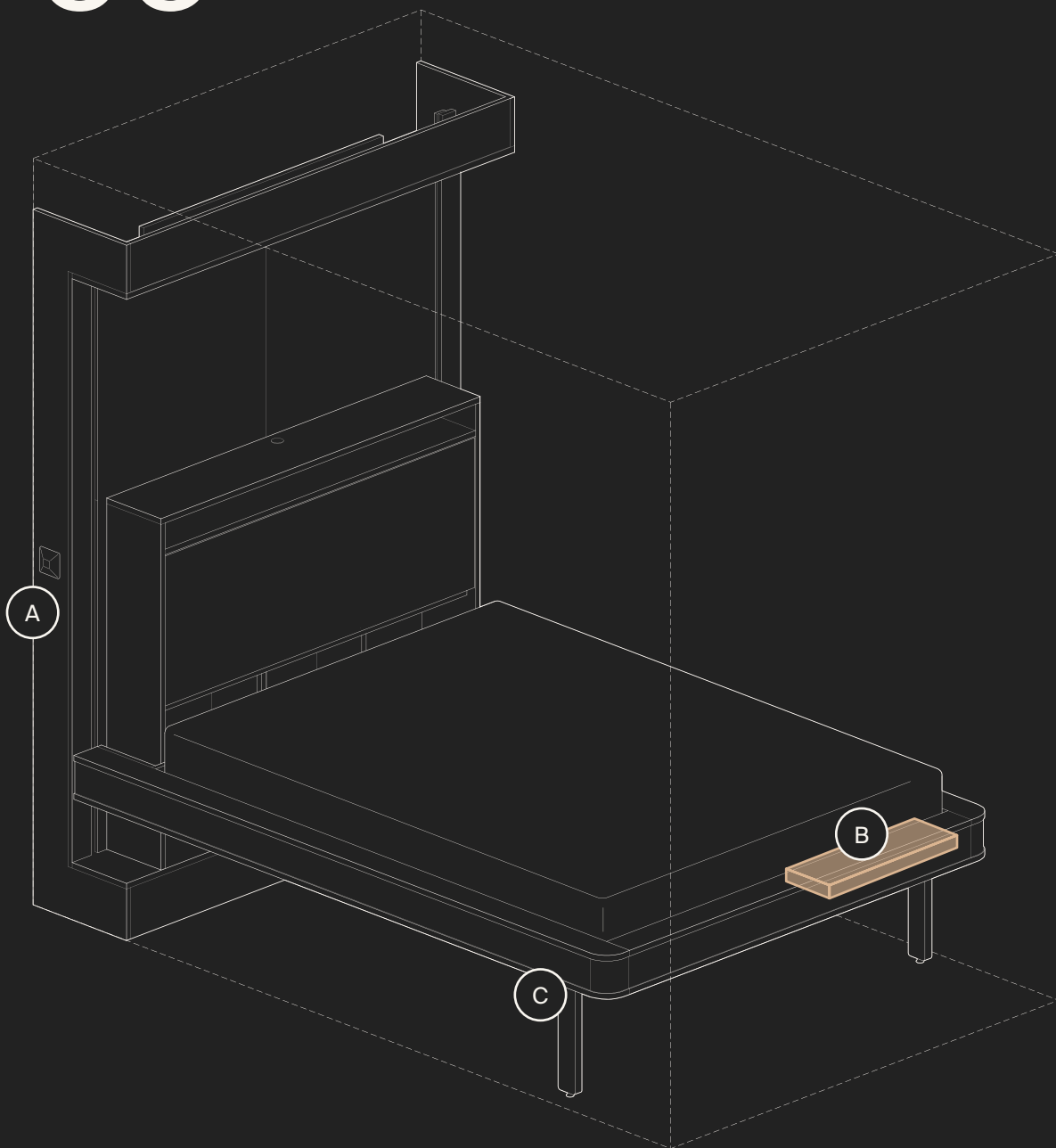

## A. RESETTING THE SYSTEM

---

The Ori Cloud Bed can be adjusted or reset if necessary (for example, after a power outage). Please visit the Ori Service Portal for guidance.

## B. ADJUSTING COUNTERWEIGHTS WITH BEDDING

---

The Cloud Bed's magic relies on a carefully balanced counterweight system, so if your bedding exceeds 30 lbs, you may experience inconsistent movement. To correct this problem and allow for smooth operation, you can remove the Cloud Bed's extra counterweight. To do so, lift the corner of the mattress where shown and remove the weight.

In the event that you remove the heavy bedding (for example, swapping out seasonal blankets in the summer), you may need to replace the counterweight. Use the guide below to check your requirements.

### SCENARIOS

**Bedding weight 0–30 lbs**

Keep bed counterweight

**Bedding weight 30–45 lbs**

Remove bed counterweight

**Bedding weight 45+ lbs**

Some bedding will need to be stored elsewhere, or contact Ori Support for help

## C. MOVEMENT IN A POWER OUTAGE

---

If the power ever goes out, fear not. The bed will NOT fall. You can gently and safely raise or lower your Cloud Bed manually. It may be helpful to grab the bed legs or bed frame when lowering the bed.

If you ever need to move your system manually for a different reason, just make sure to unplug it first. Doing so disengages the motor and enables manual movement.

# Safety

## 06

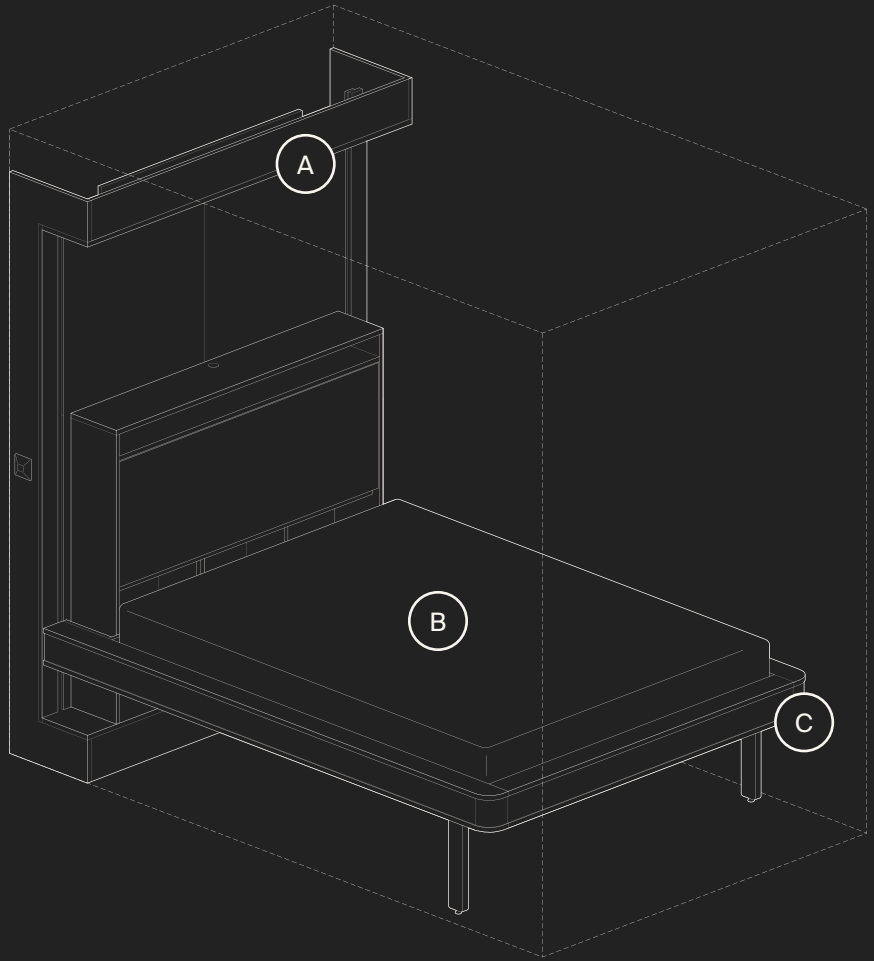

### A. CANOPY

---

Never hang or store items on the canopy. This could damage your system or cause injury or death.

### B. MATTRESS

---

Do NOT remove, flip or rotate your mattress without contacting Ori Support for guidance. The bed frame will suddenly lift toward the ceiling, which may result in injury or death, unless it is securely held in place.

### C. SAFETY-STOP

---

Ori comes equipped with an auto-stop feature, which automatically halts and retracts the system when it encounters an obstacle, such as a person, pet, or object. All it takes is the force of two fingers to halt any movement.

Note: the Cloud Bed will stop if items on the desktop or shelves get in the way. Please check for any obstructions if your Cloud Bed ever has trouble moving.

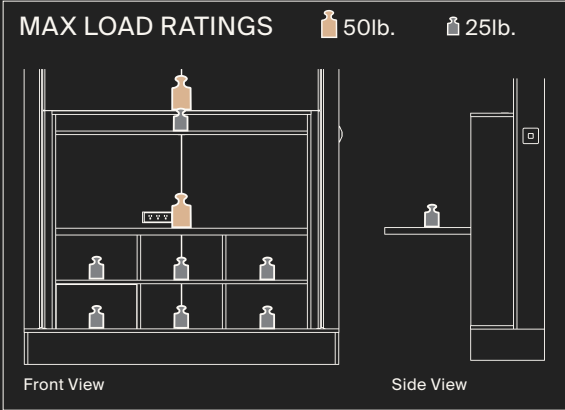
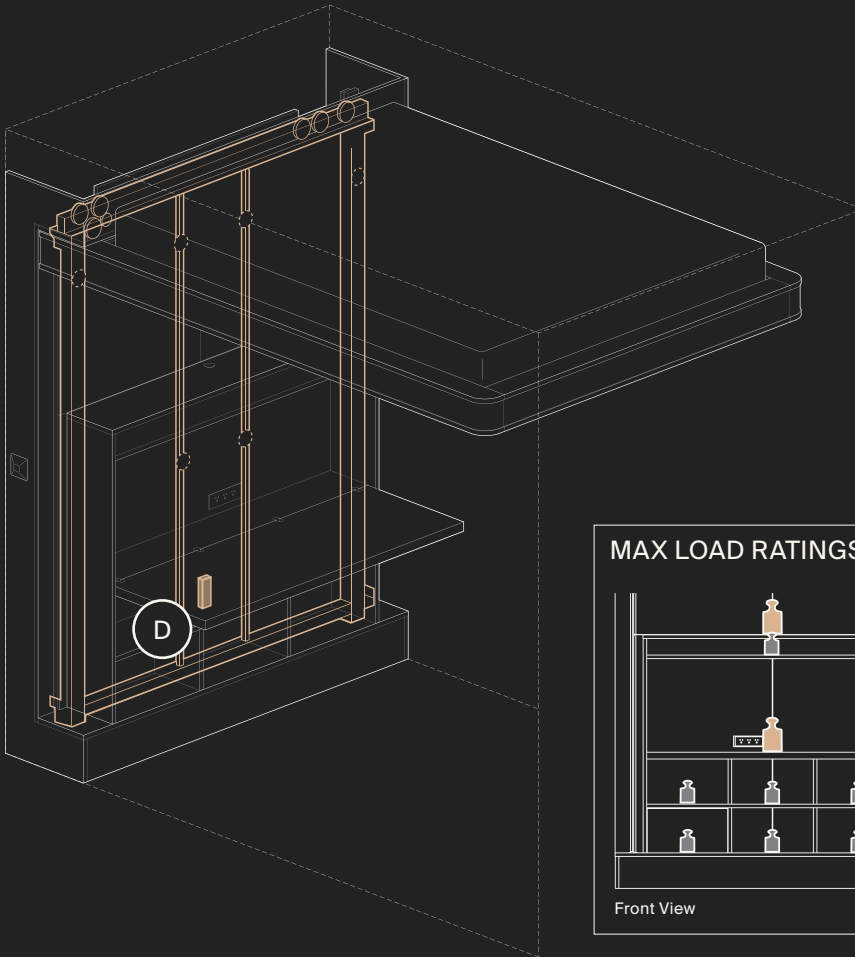

### D. OVER CURRENT PROTECTION

If too many devices that are plugged into the Cloud Bed's outlets are in use at the same time, the system's over current protection will trigger, cutting the power. If this occurs, switch off all the plugged-in devices, reset the power by pressing the red button on the control panel, and then resume use of a fewer number of devices. To access the control panel, remove the wooden back panel in the bottom-left-most shelf of the Cloud Bed's cabinet component.

Do NOT plug vacuum cleaners or hair dryers into any outlet on your Ori system.

### ELECTRICAL SPECIFICATIONS

- Input Voltage: 125Vac
- Input Frequency: 50/60 Hz
- Operating Power; moving: 55W
- Max Power; lights: 90W
- Max Power per power strip: 1320W
- Max Linear Speed: 4inch/s = 100mm/s





# Safety Notices

Household/Residential Use Only. Read all instructions before using the Cloud Bed. When using an electrical furnishing, basic precautions should always be followed, including the following:

**DANGER** - To reduce the risk of electric shock: Always unplug this furnishing from the electrical outlet before cleaning.

**DANGER** - Do not operate the bed unless you know that no child or pet is on the bed. Serious injury or death could result from a child or pet being left on a raised bed for an extended period of time.

**WARNING** - To reduce the risk of fire, electric shock, or injury to persons:

1. Unplug from the outlet before putting on or taking off parts.
2. Close supervision is necessary when this furnishing is used by, or near children, invalids, disabled persons, or pets.
3. Use this furnishing only for its intended use as described in these instructions. Do not use attachments not recommended by the manufacturer.
4. Never operate this furnishing if it has a damaged cord or plug, if it is not working properly, if it has been dropped or damaged, or come into contact with water. Contact Ori Support for examination and repair.
5. Keep the cord away from heated surfaces.
6. Never operate the furnishing with the air openings blocked. Keep the air openings free of lint, hair, and the like.
7. Never drop or insert any object into any opening.
8. Do not use outdoors.
9. Do not operate where aerosol (spray) products are being used or where oxygen is

being administered.

10. To disconnect, remove plug from outlet.

**WARNING** - Risk of Injury - Keep children away from the bed before operating. When this furnishing is in motion provide supervision and make sure that all objects, persons, and pets are free from its path.

**WARNING** - Risk of Electric Shock - Connect this furnishing to a properly grounded outlet only. See grounding instructions.

**WARNING** - If the unit is installed within 6' of a sink, it must be plugged to a branch circuit provided with Class A GFCI protection.

## GROUNDING INSTRUCTIONS

This product is for use on a nominal 120-volt circuit and has a grounding plug that looks like the plug illustrated in sketch A (see next Figure). Make sure that the product is connected to an outlet having the same configuration as the plug. No adapter should be used with this product.

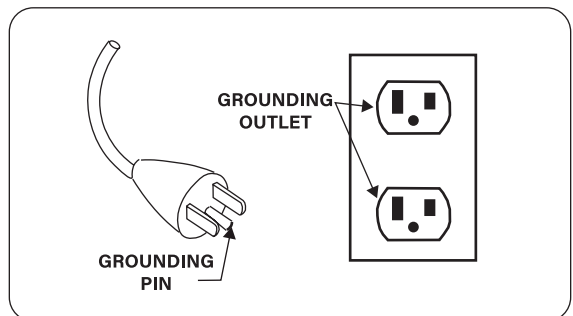

SAVE THESE INSTRUCTIONS







DOC-PLT-0105-001 Rev A  
Ori, Inc.  
12 Channel St, Suite 202  
Boston, MA 02210  
[www.oriliving.com](http://www.oriliving.com)