

*An Invitation to
History of Science*

Editor
Nagarjuna G.

**Homi Bhabha Centre for Science Education
Tata Institute of Fundamental Research**

AN INVITATION TO HISTORY OF SCIENCE

Co-ordinators Nagarjuna G.
 Arvind Kumar

Project Assistance Meena B. Kharatmal

Editorial Board Arvind Kumar
 Sugra Chunawala
 Chitra Natarajan

Script Sugra Chunawala
 V. G. Gambhir
 Nagarjuna G.
 Arvind Kumar
 Savita Ladage
 Bakhtaver S. Mahajan
 Chitra Natarajan
 H. C. Pradhan
 K. Subramaniam

Artists Anand Nakhare
 Joydeb Dasgupta
 Niaz Ali Ahmed

Cover & Layout Manoj Nair

© Homi Bhabha Centre for Science Education
Tata Institute of Fundamental Research
V. N. Purav Marg, Mankhurd
Mumbai - 400 088
www.hbcse.tifr.res.in

Contents

Chapter	Title	Page
	<i>Preface</i>	
1.	Great Leaps in Early History	4
2.	Science in Ancient Greece	16
3.	Science in Ancient India	28
4.	Science in Ancient China	40
5.	Science in West Asia	52
6.	Scientific Revolution	62
7.	The Chemical Revolution	84
8.	Physics in the Nineteenth Century	94
9.	Progress in Mathematical Thought	110
10.	Growth of Biological Thought	118
11.	Astronomy	134
12.	Linguistics	146
13.	Psychology	152
14.	Social Sciences	160
15.	Earth Science	172
16.	Physics in Twentieth Century	178
17.	Chemical and Materials Science	190
18.	Progress in Biological Thought	206
19.	Computer Science	218
	<i>Outlook</i>	226

Preface

The historical dimension of science scarcely appears in our school and college curricula. Most students tend to view science as a finished product that has been largely imported from the West. Textbooks occasionally do pay lip service to the history of science by inserting photographs of great scientists and giving their short biographical sketches. The main body of the texts, however, hardly brings out the developmental nature of science. Yet, if there is one criterion that distinguishes scientific enterprise from other endeavours, it is that with time science evolves, grows richer, becomes at once more complex and unifying, encompassing more and more domains of experience. Science is not static. It has an arrow of time in the direction of progress. Scientific knowledge is often viewed as a product of western culture alone. Yet, it is now widely appreciated that science has drawn inputs from the rich cultural experiences of the Arabs, Indians and Chinese among others. It may be possible to understand particular topics of science without reference to its history. However, to appreciate science deeply and imbibe its ethos, it is necessary to understand the cultural and historical contexts of its growth. This book is a part of HBCSE's efforts to inculcate a developmental view of science among students and to heighten their awareness of the contribution of India to the global enterprise of science. It is a modest but comprehensive exhibition that begins with the great leaps our ancestors made in fathoming nature, journeys past the different milestones in the history of science and concludes with a brief description of the monumental achievements of twentieth century science.



Science has multi-cultural origins. The arrows in the map indicate our current historical understanding of the flow of knowledge among the major ancient civilizations: Greece, India, China, West Asia and finally from Arabia to Europe (red arrow). The background map shows the Eastern Hemisphere made by **Gerard Mercator (1512-94) in 1587.**

Great Leaps in Early History

The Knowing Animal

Modern science is only about 400 years old, but the preconditions that made it possible can be traced back to our early ancestors who departed radically from other animals in their habit and habitat. This departure took place roughly 5 million years ago, when the human-like primate evolved from an ape-like ancestor. The erect posture of the human ancestors not only freed the fore-limbs from the role of supporting and walking, but also opened up several new dimensions to what an animal could do. The evolution of the human ancestor to a knowledgeable animal was driven primarily by the power of the hands in conjunction with the brain.

Unlike other animals, humans can adapt to a wide variety of habitats. This adaptive ability is the product of both biological and cultural evolution. Some of the great leaps in our early history are : fashioning the available material (wood, stone, metal etc.) in the surroundings into tools and other artifacts; building shelters;

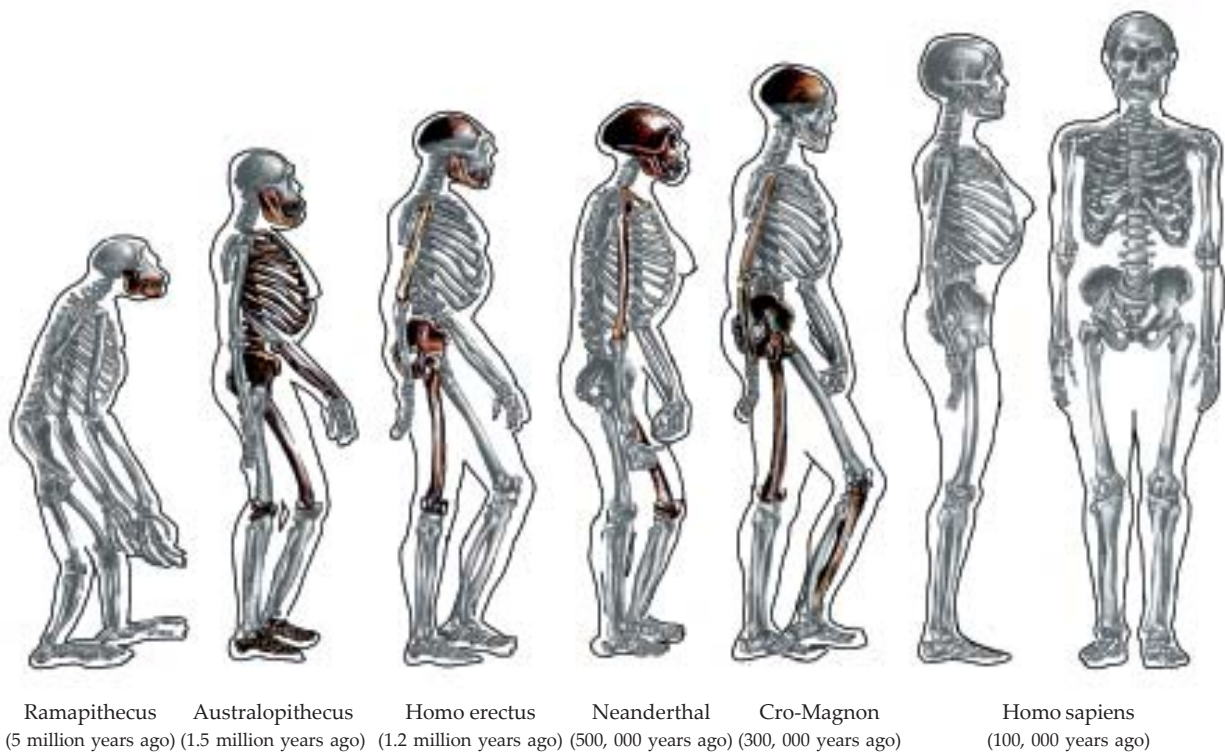

Fig 1.1: **The Evolutionary Path to Modern Human Being:** The evolutionary history of human beings has been constructed on the basis of fossils collected mostly in this century. The part of the fossil actually found is shown in brown colour, and the reconstructed part is gray in colour. The outline indicates how the animal could have looked.



Fig 1.2: The fossilized footprints of Australopithecines — two adults and a child.

making use of fire and harnessing it; cultivating plants and domesticating animals; weaving cloth; speaking and writing; creating powerful symbolic forms of expressions like paintings, dance, drama, music and so on. These different acquisitions when interwoven produced the rich and multi-dimensional social and cultural fabric of human beings, of which knowledge becomes the main thread. Scientific knowledge emerged from this rich cultural tapestry.

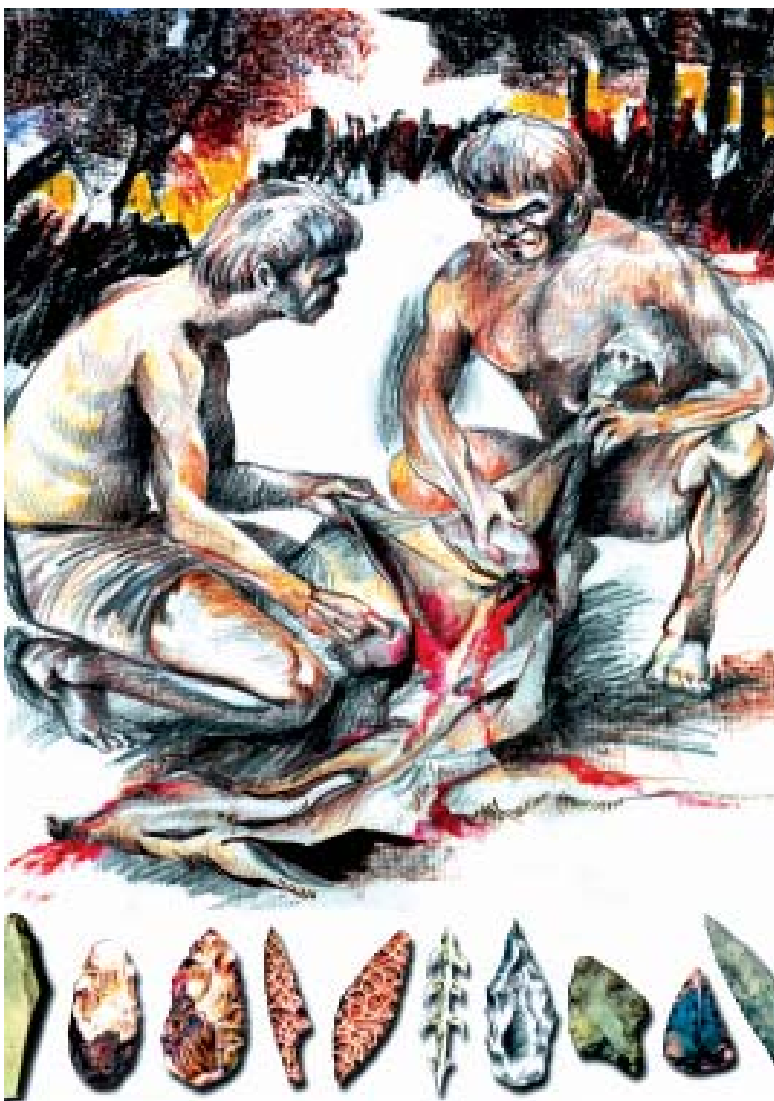

Fig 1.3: The distinctive biological assets - the brain and the hands - enabled humans to add new modes of interacting with the world around. Tools were shaped by the dexterous human hand from the naturally available sources like wood, stone, bone and clay. The picture shows the use of a stone tool for separating skin from a fresh hunt.



Fig 1.4: **Fire** may have been discovered by ancient humans accidentally from a volcanic eruption or a forest fire. The picture is an artist's impression of a group of people exploring the burnt remains after a forest fire. Humans probably discovered the usefulness of cooked food from such an exploration.



Fig 1.5: **A view of life inside a cave:** Before building artificial shelters, humans used natural caves as their dwelling during the stone age. The use of fire came in handy for driving away the wild animals from the caves.

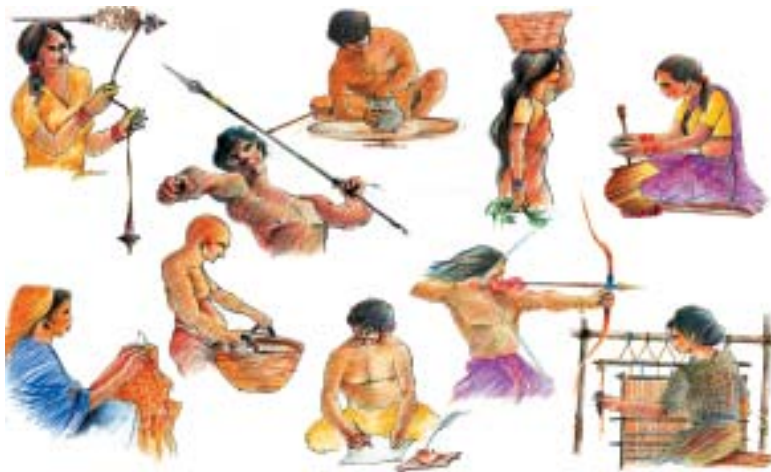

Fig 1.6: **The Roots of Human Intelligence:** The most striking anatomical asset of our body is the presence of a large number of movable and controllable joints, many of them concentrated in the two hands. The picture shows the wide variety of things human hands can do.

The Great Leaps

During the course of our history it is possible to identify a few events that have launched us to higher levels of cultural growth. Among them the most notable are: the use of tools, learning to make and manage fire, the practices of agriculture and domestication of animals, followed by the discovery of metals, and the invention of the wheel. Along the way, a distinctly human feature developed from primitive modes of animal communication: the ability to speak and much later, to write.

To the best of our present knowledge, *Homo habilis*, an ancestor of *Homo sapiens* began to shape stones into crude tools about two million years ago. The use of tools tremendously widened the scope of our interaction with the world, leading to an increase in the knowledge base. The discovery of the use of fire, possibly by *Homo erectus* who lived around 1.2 million years ago, gave humans a weapon, a weather conditioner, and an external source of energy.

A major transformation in human way of living occurred, however, only after the beginning of agriculture and domestication of animals.

Fig 1.7: **The Grain of Grass:** After our ancients discovered that cooking can transform the grains of grass weeds into valuable food, they could get food in abundance from the grass lands of the fertile river beds. Unlike other forms of food, grain can also be stored for future use. The phenomenal growth of humankind all over the globe would not have been possible without discovering the value of the grain of grass.

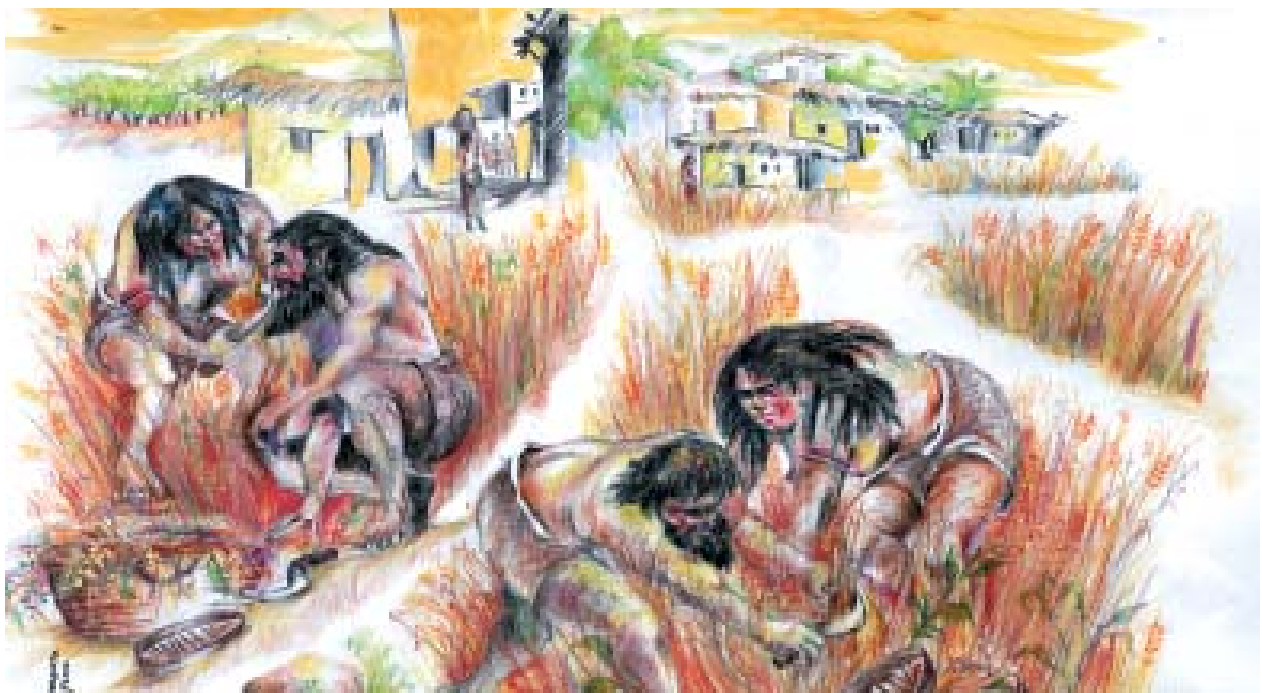

Fig 1.8: **Instances of early writings** in the form of pictographic scripts were found on tablets dating from c. 3300 BC. Pictographic scripts gradually evolved into phonetic scripts based on the source of a syllable or word not its meaning.



Agriculture brought about a new relationship between humans and nature. This was the first large-scale harnessing of the world's natural energy for the benefit of humankind. Managing agriculture called for an increase in know-how about the flora and fauna, – day-night cycles, climatic conditions, water management etc. The use of measurement must have originated in this rich setting, where the notion of property and production began to shape human relations.

Fig 1.9: **The Wheel of progress:** Following the realisation that rolling logs of wood can be transformed into a mechanism that can carry loads, the wheel has become the heart of almost every major invention. The wheel in an abstract sense is more a principle than a mere artifact. The picture shows its use in different contexts.



Fig 1.10: **Clay**, being an easily available and a highly moldable material, was used since the early days for a variety of purposes. People constructed houses out of clay, made pots for the kitchen, constructed stoves for not only cooking but even for smelting ore, made large containers for storing grain, devised toys, and shaped the clay into beautiful artistic forms. It is no surprise that the early forms of writing found their place on the surface of clay.





Fig 1.11: A Sumerian frieze of 2,500 BC depicting agricultural practices.

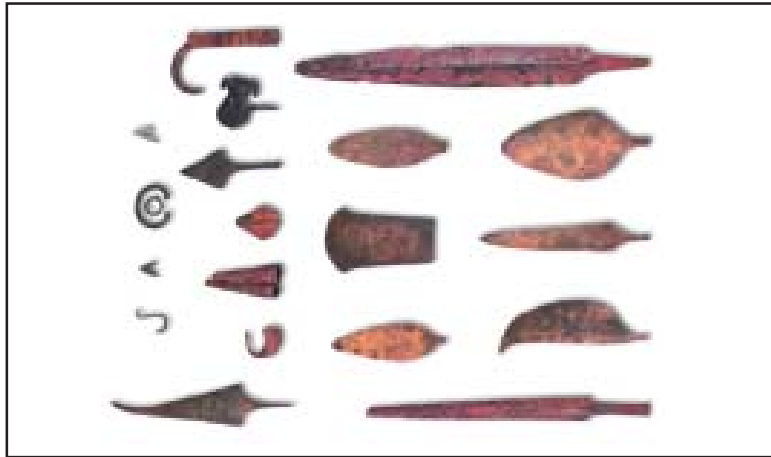
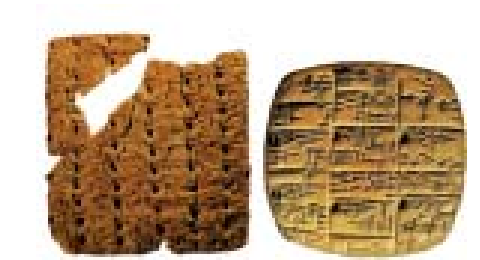

Fig 1.12: Fire continues to open up new possibilities. That fire can transform certain kinds of earth (ores) into metals like copper was realised around ten thousand years ago in the Middle East. Around 3,800 BC the extraction of bronze was discovered in Persia, but the bronze works reached their finest expression in China. The picture shows a wide variety of metal weapons found in the Indus valley.

The Early Civilisations

The discovery of agriculture posed innumerable new challenges for humans. A multifaceted activity, agriculture needed inputs from different 'corners' of the earth --- the water, the land and the sky. It provided a stable and rich socio-cultural context for generating knowledge about the world. Humans now had a greater need to take help from and communicate with each other. And, at the same time, they had more leisure to work and think on their problems. These factors spurred the development of science, technology, arts and crafts, languages, social organisation and political structures.

One of the notable outcomes of the agricultural revolution was the development of towns, particularly in the larger river valleys,



Clay tablet found in Sumeria (c. 2,360 B.C.)



Bamboo strips of China (c. 1,100 B.C.)



Silver plaque of Persia (c. 525 B.C.)



Brahmi script of India (c. 300 B.C.)

Fig 1.13: **The earliest writing** was found at Uruk in Sumeria on clay tablets dating from c. 4000 BC. A selection of writings found in other civilizations is shown above.

Fig 1.14: Civilisations of the ancient world



Fig 1.15: The valley of the river Nile nurtured the great **Egyptian civilisation** from c. 3000 BC. The Egyptians believed in the concept of divinity and immortality of their kings and queens, who were mummified and kept in the massive pyramids. The construction of a pyramid was a gigantic enterprise involving many craftsmen, surveyors, scribes and a huge work force. The largest pyramid of Giza is 146 m high and contains two and a half million blocks of limestone.

leading to the great civilisations in Mesopotamia, Egypt, India and China. Each of the early civilisations had a distinctive mark of its own, yet they had many features in common. They contributed to a wide spectrum of necessary means of measuring space and time: number systems using different bases; different standards for measuring lengths and angles; mensuration techniques leading to geometry; and different methods of measuring time based on the solar and lunar calendars.

Many of these achievements found their immediate expression in architecture and town planning. Besides the practical knowledge of arts and crafts, ancient knowledge was also abstract and metaphysical. The power of abstract knowledge began to be realised very early on. The priests harbouring this knowledge occupied crucial positions in ancient political structure, and began shielding it from others leading to a social divide. Knowledge appeared and evolved in different forms: arts and crafts, magic, rituals, religious practices and philosophical discourse.

We have come to know of the rich ancient heritage from the long lasting sculptures, metal works, inscriptions on temples and tablets, and the architectural remains. The effort to understand our past still continues.

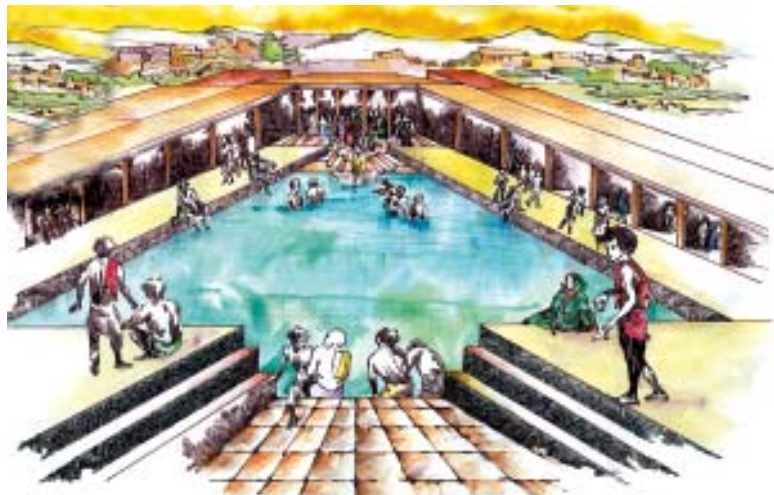

Fig 1.16: We know about the **Indus Valley civilisation** (3200-1750 BC) from the excavations of the two cities, Moenjo-daro and Harappa. These sites give evidence of the sophisticated level of town-planning and engineering techniques attained in this civilisation. The picture is an artist's impression of how the ritual bath at Moenjo-daro might have looked, based on the archaeological findings. The bath measured 39 feet long, 23 feet wide and 8 feet deep.



Fig 1.17: Egyptian tomb painting showing farm life



Fig 1.18: The **mummy cases** containing preserved dead bodies were made of wood, and were painted with pictures of gods and the hieroglyphs found on them had descriptions praising the owner. The inner coffin was often embedded in one or two outer ones.



Fig 1.19: The remarkable uniformity of length and weight measures made of stone shows the level of precision attained by the Indus civilisation. The broken ruler shown to the right of the balance has exact intervals of 0.264 inch.



Fig 1.20: The famous intricately carved **dancing girl statue**, made of bronze, measured only four-and-a-half inches.



Fig 1.21: The seals found at Moenjo-Daro carved out of soft stone have proved informative. They provide insights into the religious practices of the time and early writings, though deciphering the script continues to be a difficult challenge.



Fig 1.22: The toys of the Indus Valley, made of pottery, were ingenious with movable parts and rattling balls. Numerous stone marbles and dice were unearthed from Moenjo-Daro.



Fig 1.23: The Shang Dynasty (c. 1700 - 1100 BC) created a Bronze Age culture in the plains of Yellow River (*Huang He*) of North China. The superb craftsmanship of their ritual bronze vessels as also of their stone and jade sculptures has rarely been excelled. On the bronzes are carved intricate geometrical patterns and a variety of animal forms.



Fig 1.24: The Phoenicians (c. 1500 BC) who lived on the fertile coast of the eastern Mediterranean were shrewd traders and navigators. Their cities Tyre and Sidon were famous for expensive purple textiles.

Fig 1.25: Stonehenge: The first observatory at Britain (c. 2,000 BC)



2

Science in Ancient Greece

The Orgins of Science

The origin of science is not any singular event in history. Science is a dynamic 'multi-cultural social phenomenon to which different communities across the globe have contributed. Even in ancient times, there was considerable information exchange among different civilizations. For example, around the 7th century BC, Ionia in Eastern Greece was a centre of trade for merchants from West Asia, India and China. Trade spurred socio-cultural interactions among different people, enabling flow of knowledge.

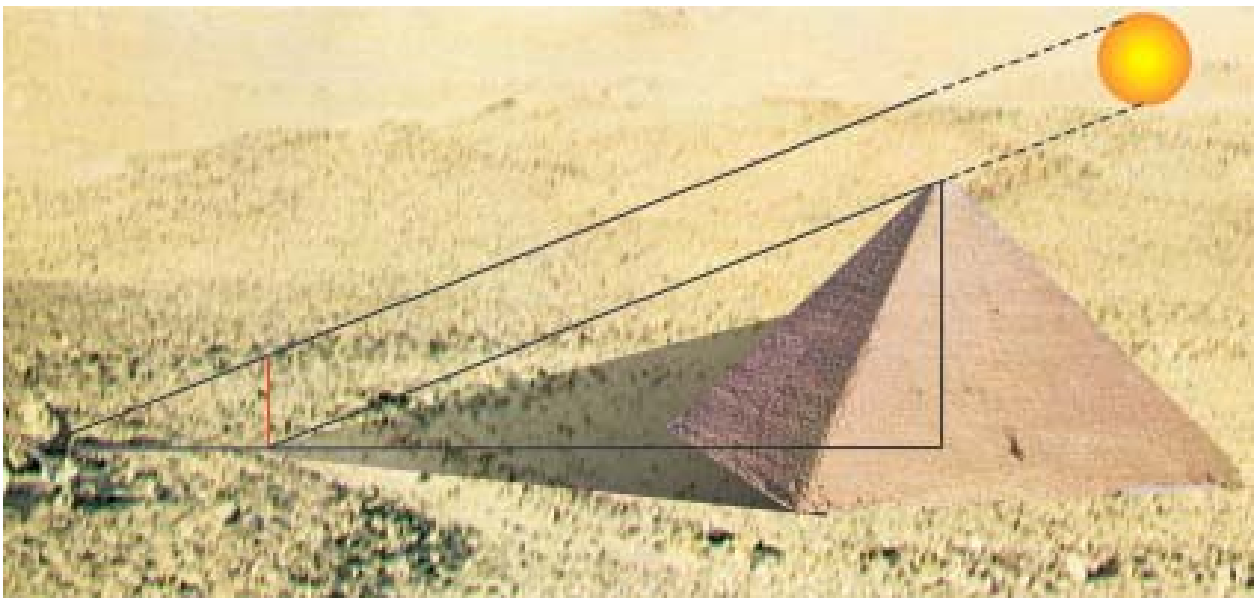

Fig: 2.1: Estimating an unknown quantity from a known quantity on the basis of the relation between the two is one of the principles of science. Thales applied this principle for estimating the height of a pyramid (unknown) by measuring the length of its shadow and the length of the shadow of a pole of known height. He generalised the principles of Egyptian geometry, and applied them in determining the distance at sea, and in (supposedly) predicting the total solar eclipse of 28 May 525 BC.

Genesis of Natural Philosophy: The thinkers of ancient Greece certainly deserve credit for sowing the early seeds of natural science, for they were the first to explain natural phenomena without recourse to myth or magic. **Thales** (c. 624-525 BC) initiated a remarkable intellectual tradition that separated investigations of the laws of Nature from religion. He also started a thread of intellectual debate based on abstract speculations about the grand structure of the world. It was common wisdom of the period that the world can be constructed out of the four elements – Earth, Water, Air and Fire. Notable thinkers **Anaximander**, **Anaximenes**, **Heraclitus**, **Pythagoras**, **Empedocles**, and **Democritus** continued the abstract speculations initiated by Thales. In modern terms, they were modeling nature on the basis of a few first principles.

While many views played a role in the debate, two distinct atomistic world views need special mention: the mathematical view of

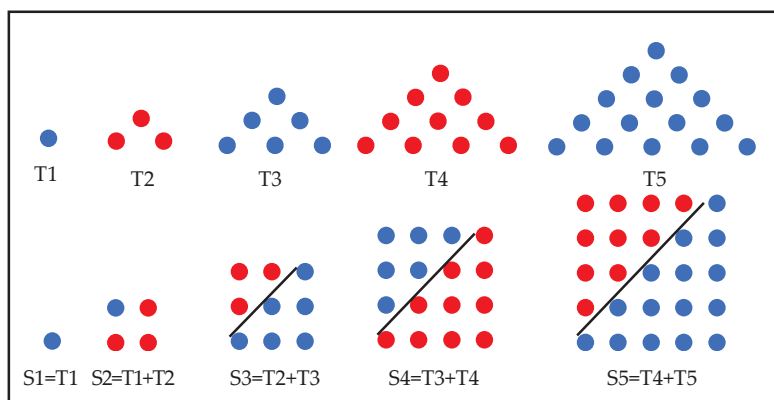

Fig. 2.2: The sum of any two consecutive triangular numbers is a square number. The discovery of this relation was attributed to Pythagoras.

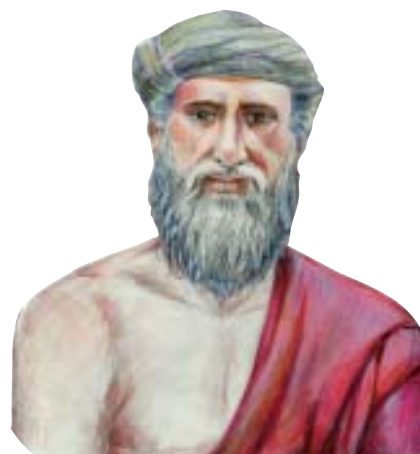

Fig. 2.3: **Pythagoras** (born c. 582 BC) was so mystified by mathematical inventions, he saw nothing but numbers in the world.

Pythagoras and the physicalistic view of Democritus. Pythagoras (born c. 582 BC) preached within an inner circle of disciples the ‘mysterious’ properties of natural numbers. He believed that every phenomenon, from matter to music, had an underlying numerical harmony. This led to the dictum: “All things are numbers.” Democritus (c. 470-400 BC) proposed that the world is made of two things, atoms and void: the indivisible lumps of material atoms in a sea of emptiness. Modern science has accommodated both these views at least in spirit.

In Athens: By about 450 BC the Greek intellectual centre had shifted to Athens. The natural philosophical tradition of Ionia did not flourish with the same vigour, with the exception of **Anaxagoras** and **Empedocles**. However, a number of systematic ideas developed by scholars in and around Athens remained part and parcel of modern science even after the dethronement of Greek Science. **Parmenides** and his follower **Zeno** strongly criticized Heraclitus’ view that everything is in perpetual change, and also the ‘mystical’ Pythagorean view of numbers. The complex and paradoxical arguments they invoked in the process generated the conceptual distinction between the subject and predicate, laying the foundations of a syntactical study of language and also logic. In this backdrop that **Socrates** (c. 470-399 BC) introduced critical thinking by raising

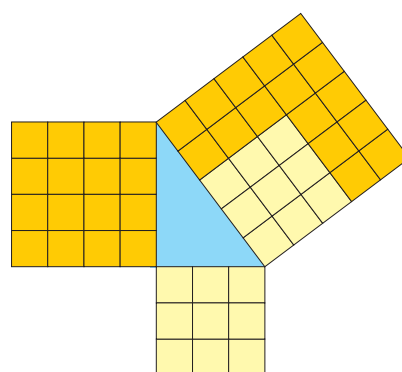
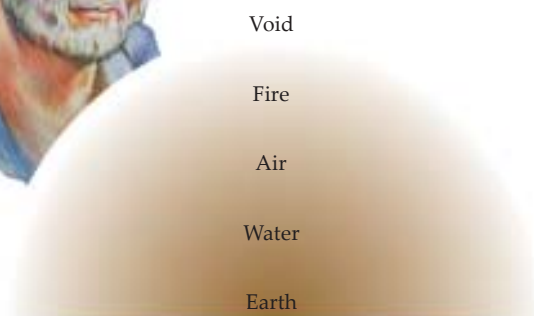

Fig. 2.4: **Pythagorean theorem:** The square on the hypotenuse of a right-angled triangle is equal to the sum of the squares of the other two sides. Though known by his name, this theorem was certainly known to his predecessors, as well as to other scholars in East and West Asia.



Fig. 2.5: According to Democritus all matter was made up of differentially spaced out atoms. It is the relative density of atoms that distinguishes one element from another. Aristotle on the other hand believed that there are four absolutely distinct substances. It was Democritus’ relativistic view that influenced later scientists, particularly Galileo, to overthrow the dominant Aristotelian world view.



Democritus’ world view



Aristotle’s world view

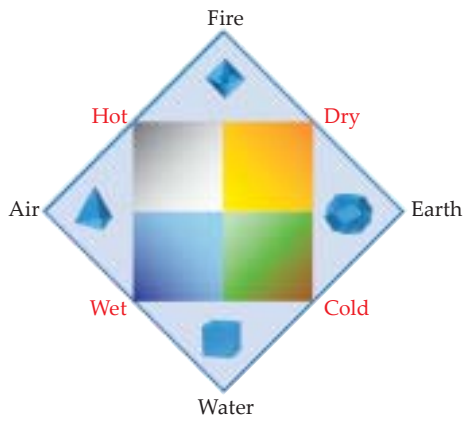

Fig: 2.6: **Empedocles' view of the world:** Greek thought was constrained by opposites and affinities. Empedocles held that all matter was composed of two opposing pairs of elements (water and fire; earth and air), and two opposing pairs of qualities (hot and cold; wet and dry). Differential combinations of these primary elements and qualities were held to produce everything in the world.

some deeper questions: What is knowledge? What is true and valid knowledge? How do we arrive at knowledge? What is virtue? Who is virtuous? And so on.

Plato (427-347 BC) developed in his own way the tradition of critical thinking initiated by his teacher Socrates, and wrote several classic dialogues on various topics. His school, *Academy*, at Athens became a centre for learning philosophy, mathematics and polity. Plato's contribution to science is mainly by way of setting the standards of systematic thinking rather than in the content of science. He introduced the need for clear definitions in a scientific discourse, laying the foundations for deductive reasoning. Plato was influenced by **Eudoxus** (c. 409-356 BC) who developed axiomatic presentation of geometric theorems, which were adopted and developed later by Euclid. Plato's student **Aristotle** (384-322 BC) developed this further into a full fledged system of deductive and inductive logic, though he abhorred mathematics.

Aristotle, unlike his predecessors, began exploring *specific problems* such as: What makes a body move? What forces act on a stone thrown upwards? Why do objects thrown upward begin to fall back? Though his answers are not in consonance with modern science, his wide ranging theories in physics and biology influenced the Western and Arabian scholars till the onset of the scientific revolution in the 17th century. Plato and Aristotle are unquestionably among the greatest thinkers of all time.

The period from Thales to Aristotle remains one of the most productive in intellectual history, giving birth to various ideas and metaphors that have directly or indirectly stimulated scientific imagination.

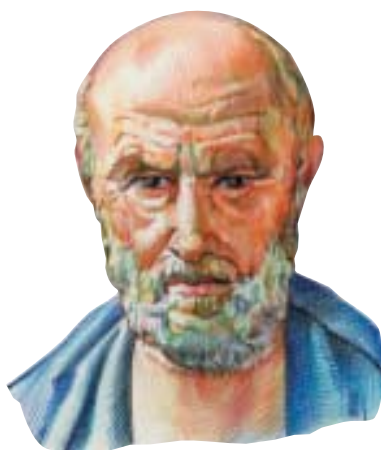

Fig: 2.7: **Hippocrates of Cos** (born 460 BC), who is supposed to have written sixty important texts known as the 'Hippocratic Corpus', preached the doctrine of 'humours'. Though this theory was not new, he rationalised it on the basis of the Pythagorean notion of 'balance as health' and Empedocles' theory of the four elements. Hippocrates is known to this day for his ethical prescription in medicine in the form of *Oaths*.

Hippocratic Oath

I swear by Apollo the physician, and Aesculapius, and Health, and All-heal, and all the Gods and Goddesses, that, according to my ability and judgement, I will keep this Oath and this stipulation to reckon him who taught me this Art equally dear to me as my parents, to share my substance with him, and relative his necessities if required; to look upon his offspring in the same footing as my own brothers and teach them this art, if they shall wish to learn it, without fee or stipulation; and that by precept, lecture, and every other mode of instruction. I will impart a knowledge of the Art to my own sons, and those of my teachers, and to disciples bound by a stipulation and oath according to the law of medicine, but to none others. I will follow that system of regimen which, according to my ability and judgement, I consider for the benefit of my patients, and abstain from whatever is deleterious and mischievous. I will give no deadly medicine to any one if asked, nor suggest any such counsel; and in like manner I will not give to a woman a pessary to produce abortion. With purity and with holiness I will pass my life and practice my Art. I will not cut persons laboring under the stone, but will leave this to be done by men who are practitioners of this work. Into whatever houses I enter, I will go into them for the benefit of the sick, and will abstain from every voluntary act of mischief and corruption; and, further from the seduction of females or males, of freemen and slaves. Whatever, in connection with my professional practice or not, in connection with it, I see or hear, in the life of men, which ought not to be spoken of abroad, I will not divulge, as reckoning that all should be kept a secret. While I continue to keep this Oath unviolated, may it be granted to me to enjoy life and practice the Art, respected by all men, in all times! But should I trespass and violate this Oath, may the reverse be my lot!



Fig. 2.8: The Greek world around 450 BC

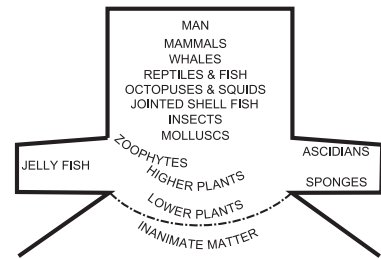

Fig. 2.9: Aristotle's famous 'ladder of nature' showing the arrangement of living species in a hierarchical order. Each species is essentially different from the other, despite affinities, and no evolutionary transformation is possible between the species.



Fig. 2.11: **Socrates (470-399 BC)**: The most revered figure in the Greek intellectual history. The conservative rulers of the time misunderstood the critical and exploratory nature of his essentially philosophical discourse. He was sentenced to death for allegedly corrupting the youth by propagating his unconventional ideas and developing questioning attitude among them.

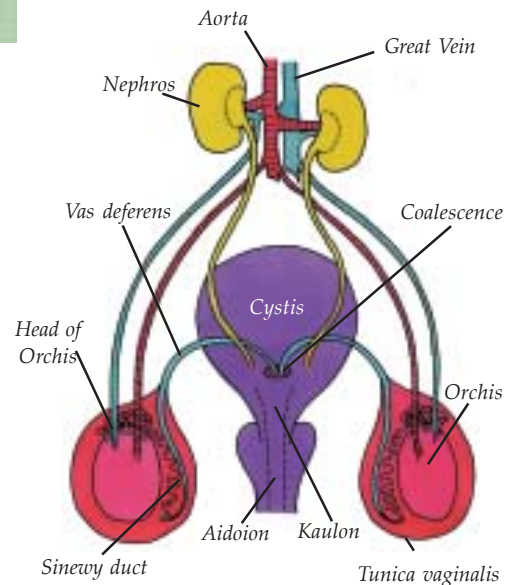

Fig. 2.10: Diagram of reproductive and excretory systems of a mammal based on the description given, by Aristotle in his book 'Historia animalium'.

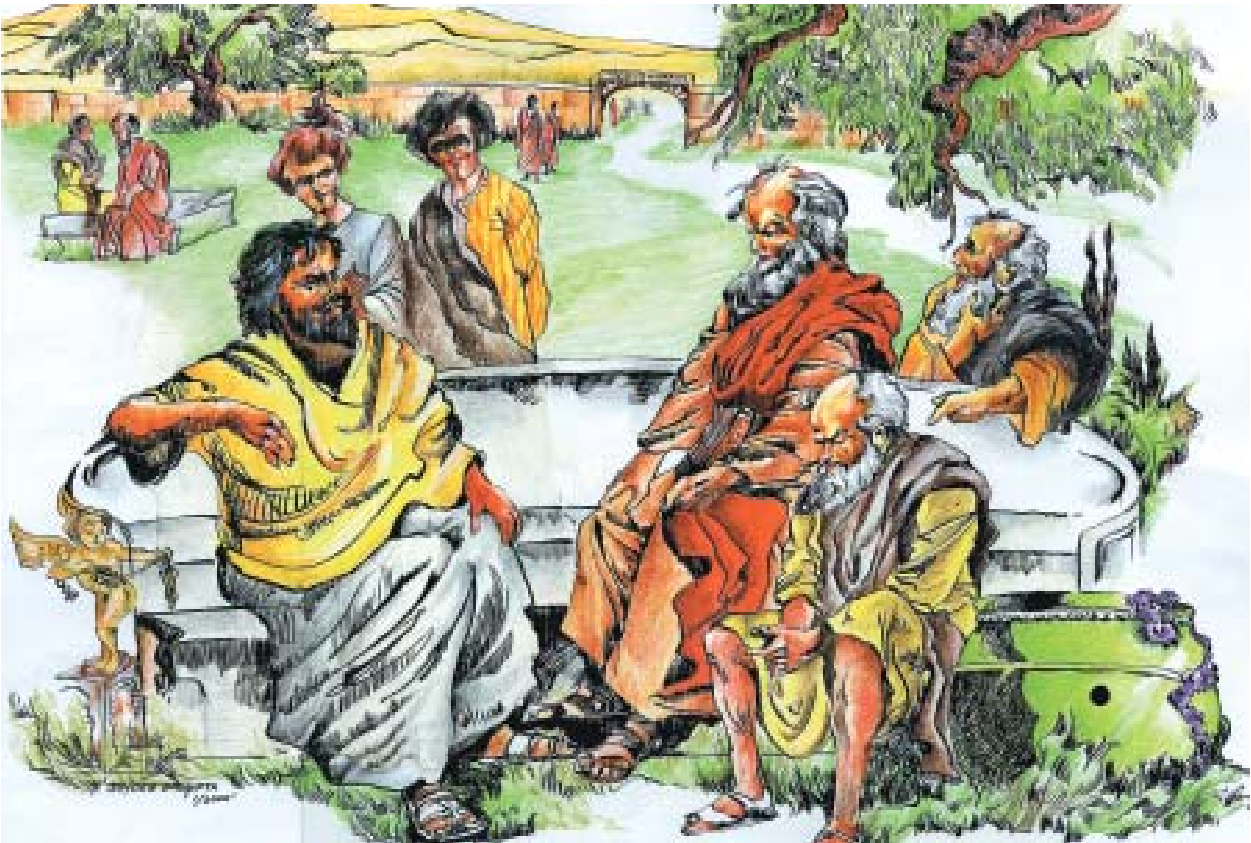

Fig: 2.12: An artist's impression of the two great philosophers engaged in a debate in the **Academy**. Plato and Aristotle held different, and often divergent views. But the critical intellectual culture of Greece at the time did not prevent them from engaging in a healthy dialogue.

Fig: 2.13: **Platonic Solids**

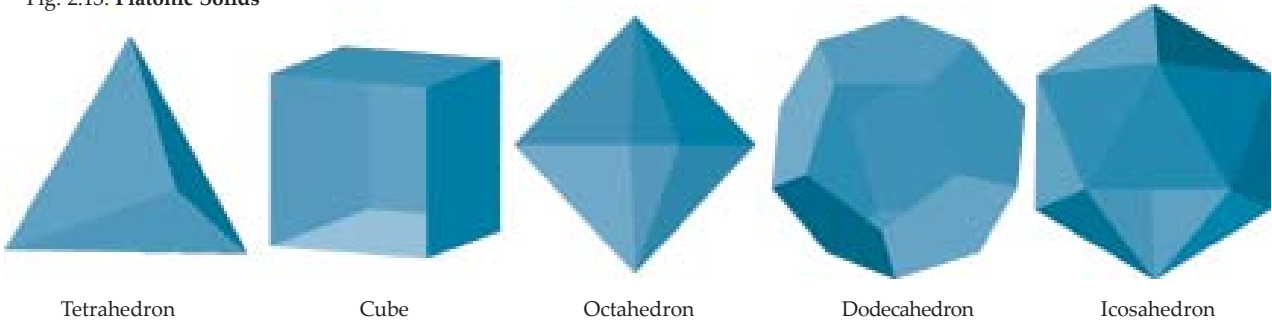

Fig: 2.14: **Euclid (c.330-260 BC)**

In Alexandria

After the death of Alexander, Egypt was ruled for three centuries by the Ptolemaic dynasty that greatly patronised learning. From 320 BC to 170 AD we see a remarkable development of systematic knowledge in and around Alexandria, where a library and museum were also founded.

A great milestone of early Alexandrian period is the monumental work by **Euclid** (c.330-260 BC): *Elements*. This work put together all the earlier knowledge of geometry, elaborated it and presented it as a logical deductive system of propositions containing axioms, postulates, theorems and proofs. The book contained, among others, the proofs of the Pythagoras theorem and the infinity of prime numbers. The influence of Euclid's work on western scientific thought was as profound as that of the Bible on western society.

Archimedes (c. 287-212 BC) was a genius, who applied Euclidean Geometry to explain how machines work by invoking the principle of balance. His discovery of the concept of specific gravity is perhaps the first measured *theoretical dimension* in the history of science. In his mathematical investigations, he came close to the concept of limit that is basic to calculus. He perfected the art of reducing the unknown to the known: a methodological principle of science. Galileo, in the 17th century, used Archimedian reasoning to overthrow the dominant Aristotelian world view. It may not be inappropriate to describe him as the father of mathematical physics.

Fig. 2.15: Conic cuts of Apollonius



Circle



Ellipse



Parabola



Intersecting lines



Hyperbola



Fig. 2.16: A page from **Euclid's Elements**: The book dealt with plane and solid geometry, proportion and properties of numbers.

Euclid's Axioms and Postulates: Axiomatic thinking was a Platonic legacy, initiated by Eudoxus, and further developed by Euclid. An axiomatic system is constructed on the basis of a few assumptions (axioms) and definitions, based on which a set of theorems can be deduced. It has become a powerful tool of science and mathematics ever since.

Euclid's Axioms

- Things equal to the same thing are equal.
- If equals are added to equals the sums are equal.
- If things are subtracted from equals, the remainders are equal.
- Things which coincide with one another, are equal to one another.
- The whole is greater than the part.

Euclid's Postulates

- A straight line can be drawn from any point to any other point.
- A finite straight line can be drawn continuously in a straight line.
- A circle can be described with any point as center, and with a radius equal to any finite straight line drawn from the centre.
- All right angles are equal to each other.
- Given a straight line and any point not on this line, there is, through that point, one and only one line that is parallel to the given line.

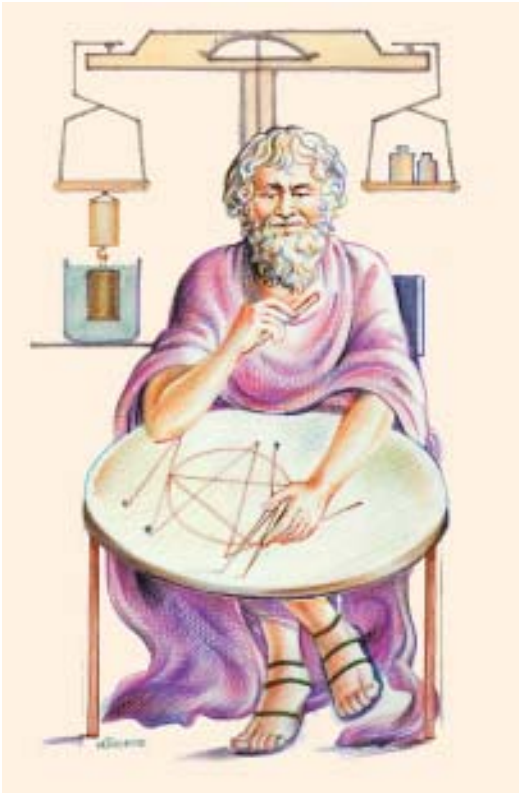
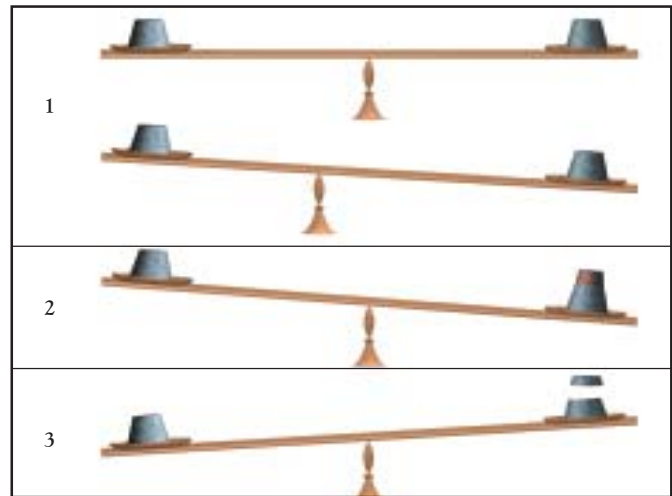

Fig: 2.18: Archimedes (287-212 BC)

Fig: 2.17: Archimedes in his treatise *On the Equilibrium of Planes* has discussed the principles of the lever and the centre of gravity. The following three postulates represent a model of equilibrium.



1. Equal weights at equal distances are at *equilibrium*, and equal weights at unequal distances are not in equilibrium, but incline towards weight which is at the greater distance.
2. If, when weights at certain distances are in equilibrium, something be *added* to any one of the weights, they are not in equilibrium, but incline towards that weight to which the addition was made.
3. Similarly, if anything be *taken away* from one of the weights, they are not in equilibrium, but incline towards the weight from which nothing was taken.

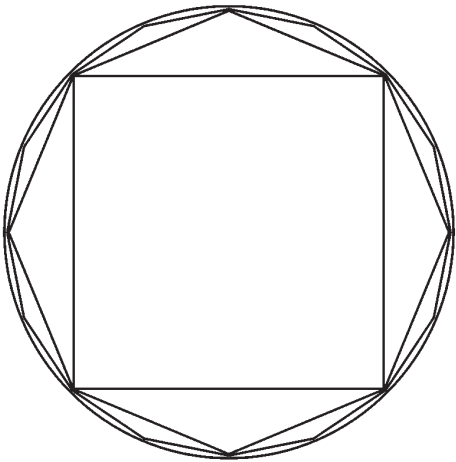
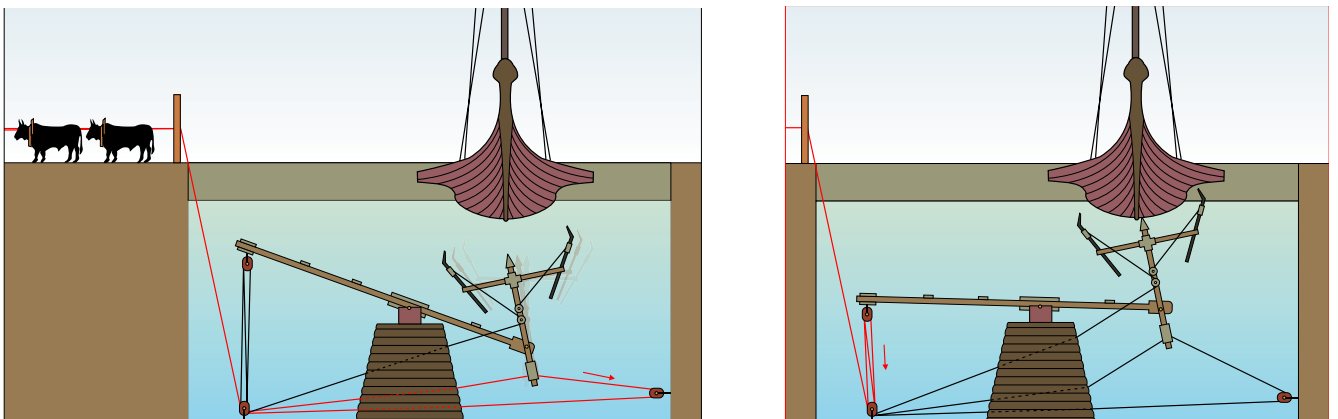

Fig: 2.19: **Estimating the Value of π using the Principle of Limit:** To find the ratio of circumference to diameter of a circle, Archimedes approximated the circle by regular polygons both inscribed and circumscribed, and tried to obtain the limits of the perimeter to side ratio, as each side became increasingly small. He found the limit to lie between $3\frac{10}{71}$ and $3\frac{10}{70}$, a good approximation to the modern value of π .

Fig: 2.20: **The Ship-shaker** designed by Archimedes at Syracuse harbour in 214 BC displays the elaborate system of levers. Many war machines designed by Archimedes were used to defend the city.



“Proposition 3: Of solids those which, size of size, are of equal weight with a fluid will, if let down into the fluid, be immersed so that they do not project above the surface but do not sink lower....”

“Proposition 4: A solid lighter than a fluid will, if immersed in it, not be completely submerged, but part of it will project above the surface....”

“Proposition 7: A solid heavier than a fluid will, if placed in it, descend to the bottom of the fluid, and the solid will, when weighed in the fluid, be lighter than its true weight, by the weight of the fluid displaced.”

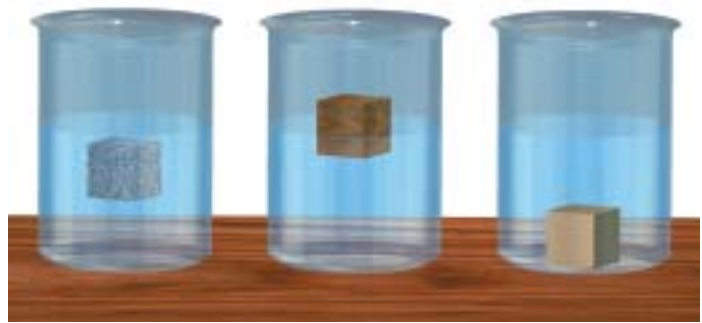

Fig: 2.21: Pictures describing the principles of hydrostatics from Archimedes' book *On floating bodies*.

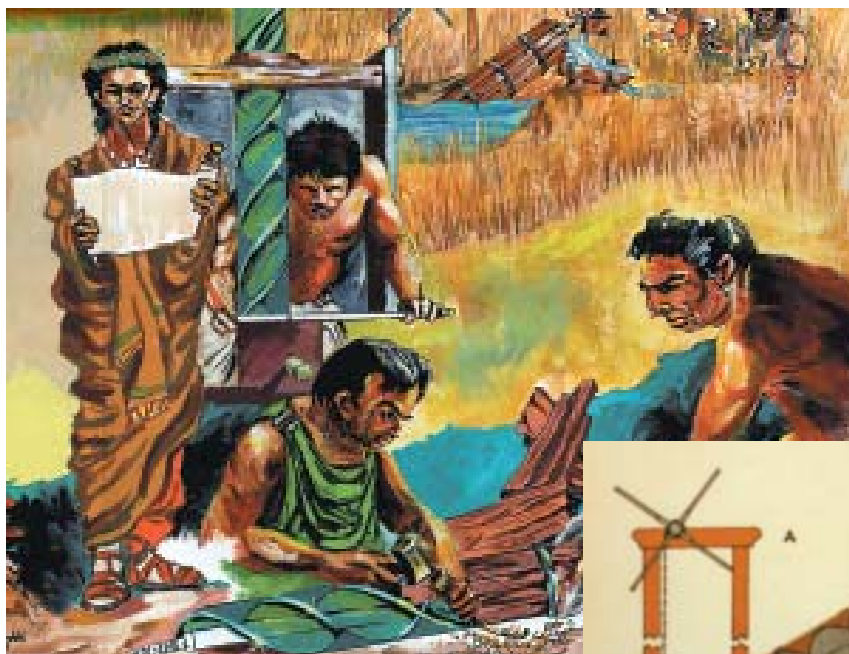
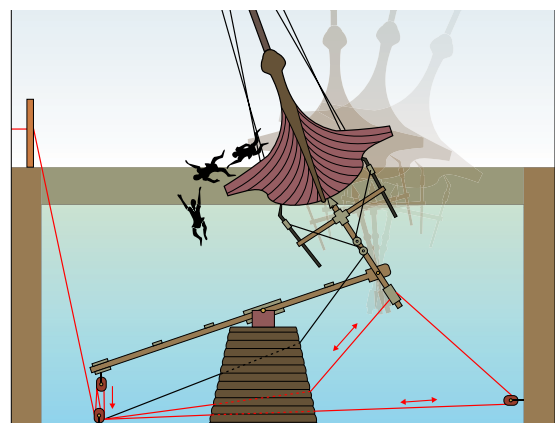
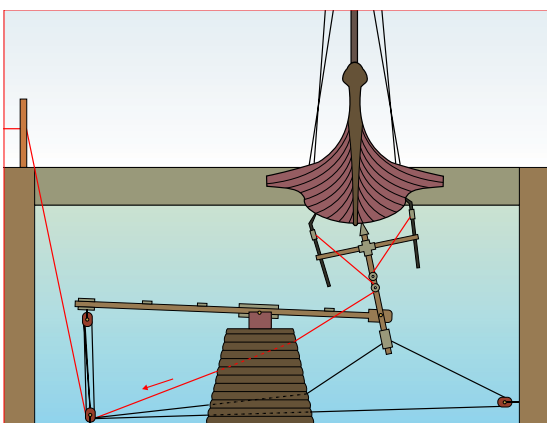
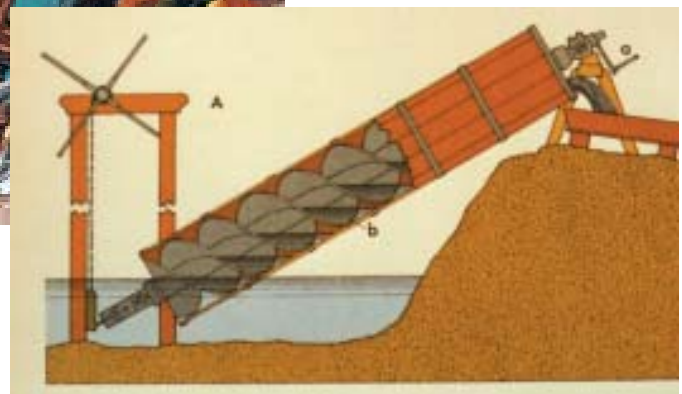

Fig: 2.22: **The Screw of Archimedes:** As the handle rotates, water is brought into the helical screw which brings it up to a trough. The method is still used in Egypt and other parts of the world for irrigating fields.



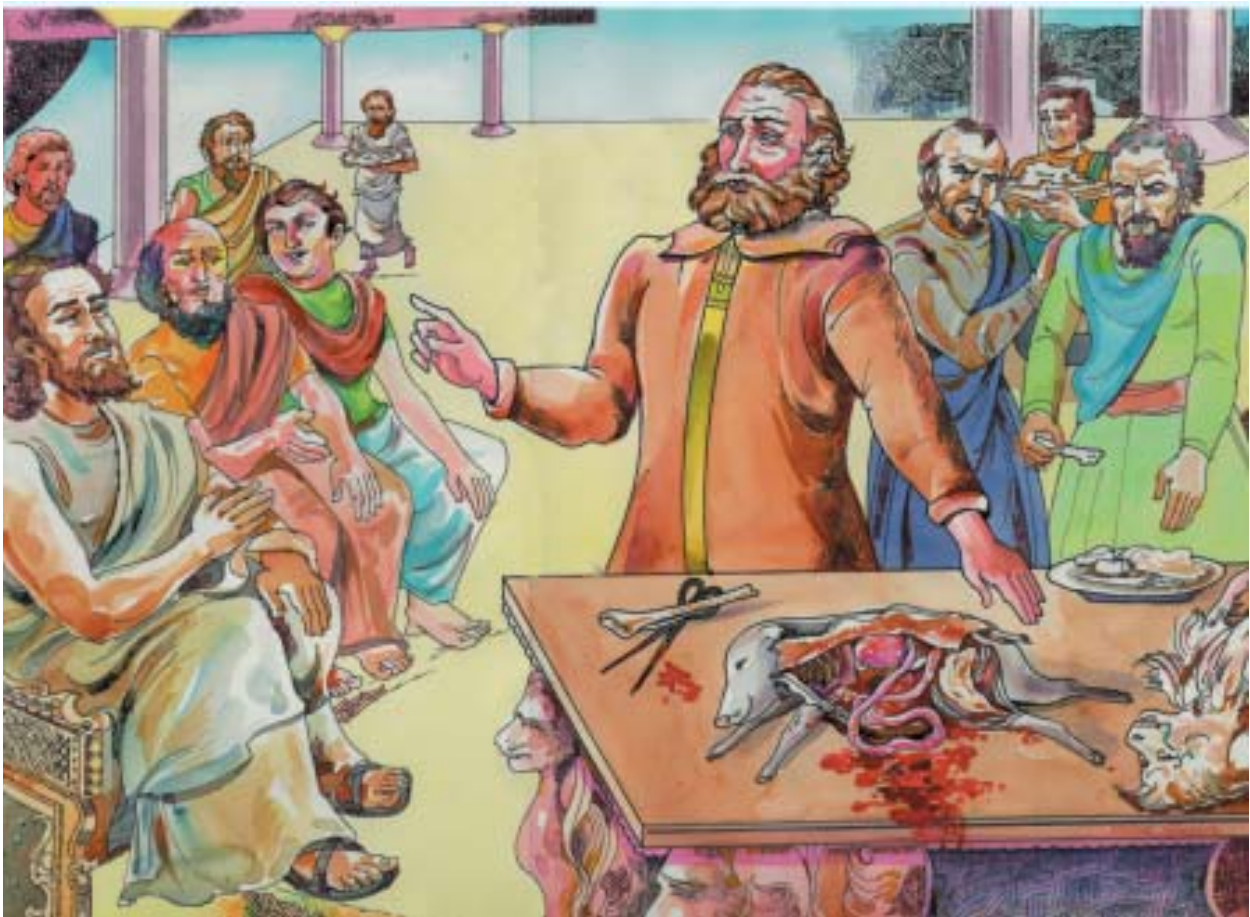

Fig: 2.23: An artist's impression of Galen performing dissection of a pig. It is known that the physicians at Alexandria used both domestic animals and dead human bodies for understanding anatomical features, and related their knowledge to various pathological conditions.

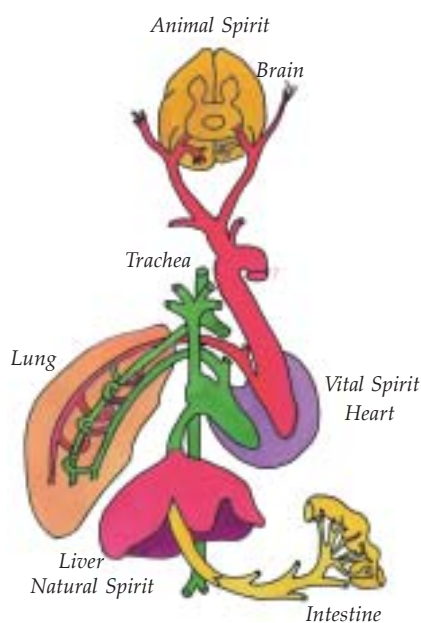

Fig: 2.24: Galen's description of circulatory system: Galen preached that 'pneuma', the natural spirit, is the living substance. So long as it is present and circulated to other parts, as suggested in the picture, the organism remains alive.

Apart from Euclid and Archimedes, Alexandria produced many notable scientists and mathematicians. **Apollonius** wrote *On Conics*, which was a study of various curves obtained by slicing a cone. He is also remembered for discovering the notion of *epicycle* for describing planetary motion. **Eratosthenes** applied mathematics to geography, considered the earth as a globe, divided it into zones, and most importantly, measured the earth's circumference using a simple but brilliant idea. **Hipparchus** developed spherical trigonometry, compiled precise astronomical data, and arrived at the important idea of the 'precession of the equinoxes'.

In medicine and physiology too, scholars of Alexandria made significant contributions. The physician **Herophilus** conducted dissections of the human body. He noted, among other things, that the brain and not the heart is the centre of the nervous system. **Erasistratus** was known for carrying out examination of dead bodies. One of the most influential medical treatises ever written was by **Galen** (131-201 AD), who documented much of the Greek medicine and physiology that we read today. His theories, though unacceptable from the modern point of view, dominated till the medieval period.

A great achievement of the last phase of science in ancient Greece was **Ptolemy's** work on astronomy. Though he also worked in developing geography, *Almagest* (*Al Majisti*) was Ptolemy's crowning glory. It was a vast compendium of Greek astronomy up to his own day, and contained results of his original work on the theory of planetary motion. It also contained a catalogue of star positions and a new extensive table of chords.

Science in ancient Greece, a monument to human intellectual creativity, came to an end with Ptolemy. In 269 AD the library in Alexandria was damaged by invasions, and was partially burnt by the Queen of Palmyra who captured Egypt. A woman mathematician and philosopher, **Hypatia**, who was the head of the museum was brutally murdered by the monks, and an incensed mob burned the library. During this uncertain period many scholars fled to Arabia, carrying with them the wealth of Greek learning. This was recovered by the Europeans during the medieval period.

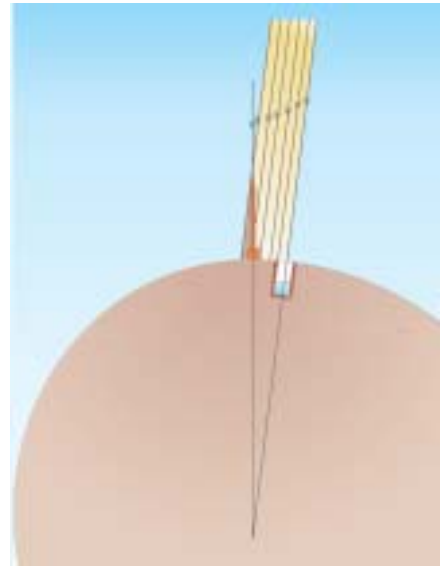

Fig: 2.25: The diameter of the earth was measured (c. 200 BC) by the Greek geographer **Eratosthenes**. On a mid-summer day, when the sun was known to be directly overhead at the Egyptian town of Syene, he measured the shadow cast by a vertical pole at Alexandria and found the angle of the sun from the vertical to be 7.2 degrees. Knowing the distance between the two towns, he estimated the circumference of the earth to be 40,555 km, close to the modern accepted value (40,074 km)



Fig: 2.26: Ptolemy (c. 85-165 AD)



Fig: 2.27: **The Ptolemaic System** was geocentric. The earth was thought to be stationary at the centre and all heavenly motions were circular. The illustration shows the orbits of the moon, the sun, the planets (Mercury, Venus and Saturn) surrounded by the stars.

Fig: 2.28: Alexandria Map





Fig: 2.29: **The Library at Alexandria** is estimated to have had a collection of more than 700,000 papyrus rolls. It was founded by **Ptolemy I**, one of Alexander's generals. A great centre of learning, influenced by the Greek tradition, Alexandria attracted leading scholars of the time.



Aelopile



Organ



Holy-water slot machine

Fig: 2.30: **Hero** was a great engineer of the Alexandrian school. One of his best known inventions, '**The Aelopile**', converted heat into mechanical energy through the medium of steam. '**The Organ**' used the pressure principles of both air and water. '**The Holy-water slot machine**' passes a little water each time a coin is dropped into it. These are just a few of the hundreds of machines invented by the Alexandrian engineers.

3

Science in Ancient India

The Vedic Period

Early systematic and deep thought appeared in the Indian subcontinent during the Vedic Period (between 1500 BC and 600 BC). The *Vedas* are verbally transmitted, codified storehouse of knowledge in the form of verses and hymns, available today as scriptures in Sanskrit. The *Vedas* are regarded in Hinduism as the ultimate source of truth, in which the spiritual and physical beliefs appear inter-mingled.

Fig: 3.1: **Lothal dock:** Archaeological excavations at Lothal show the presence of a huge dockyard near the gulf of Cambay. A rectangular structure built of baked bricks, in c. 2500 BC, spanned 37 metres from east to west and about 22 metres from north to south. The dock had been a centre for trade with ancient Egypt and Mesopotamia. It was one of the greatest products of maritime architecture of the period. The dock was used for berthing ships and had a warehouse for storing the cargo.

Unlike the Greeks and the Chinese, Indians during the Vedic period did not keep detailed records of astronomical observations, or construct any star catalogues. Only the constellations around the zodiac and a few of the bright stars away from the zodiac find mention in the texts. Astronomical observations focussed mostly on the sun and the moon for determining the calendar. A very sound knowledge of time is evident in the Vedas, in the form of calendars that were used extensively for determining the time of rituals. Around 1000 BC (Rigvedic period), people knew how to extract metals such as gold, silver and copper and make alloys like bronze. The Vedas had elaborate descriptions of human ailments, though their causes were attributed to punishment by the gods against





Fig: 3.2: **Bead making:** Bead making was developed as an industry around Lothal, a major site of the Indus Valley Civilization. The industry had a courtyard and 11 rooms, which included workers' quarters, warehouses and guard rooms. Beads were made in a chambered kiln by grinding materials, rolling them on a string and then baking them to give the required shape and size. Metal drills were used to make holes through the stone beads. The picture shows an artist's impression of a bead making workshop, and the insets show the photograph of the metal drill (obtained during the excavations) and beads in different colours and shapes.

human sins, and the treatments normally consisted of religious sacrifices. One also finds a description of anatomical features of the human body and sacrificial animals like the horse.

Indians were at their best in Arithmetic. They counted in tens, and had words for very large numbers up to 10^{12} . Sulvasutras (manuals for construction of sacrificial altars) composed in 500 BC are part of the Yajurveda. They used the Pythagorean theorem to solve difficult problems of equivalent areas. These problems cropped up in constructing altars of a given geometric shape. The Sulvasutras also contained geometrical proofs. Some operations with fractions and irrational numbers are discussed and good rational approximations for irrational numbers such as $\sqrt{2}$ and $\sqrt{3}$ are found in the sutras.

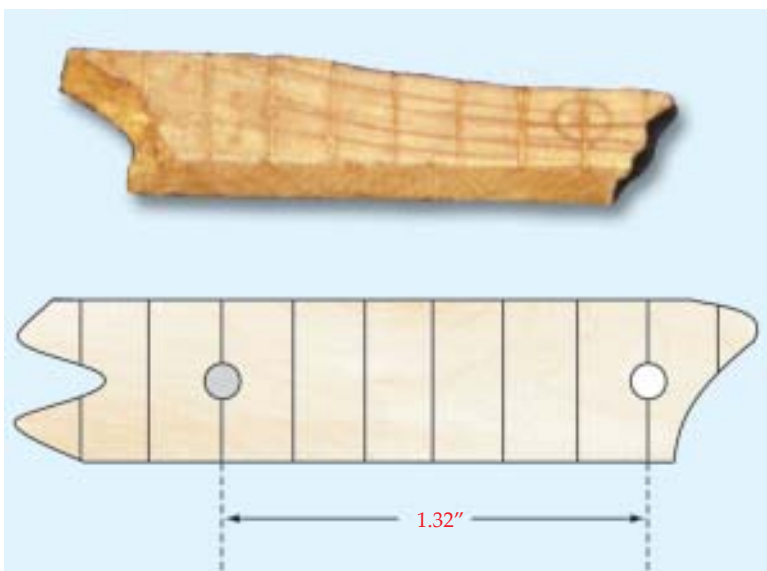

Fig: 3.3: **An Indus scale:** The wooden scale used for measurements during the Indus Valley Civilization shows nine parallel cuts, with one of them marked by a fine circle and the sixth line from it by a dot. The distance between the circle and the dot is 1.32 inches.



Fig: 3.4: Map of Ancient India

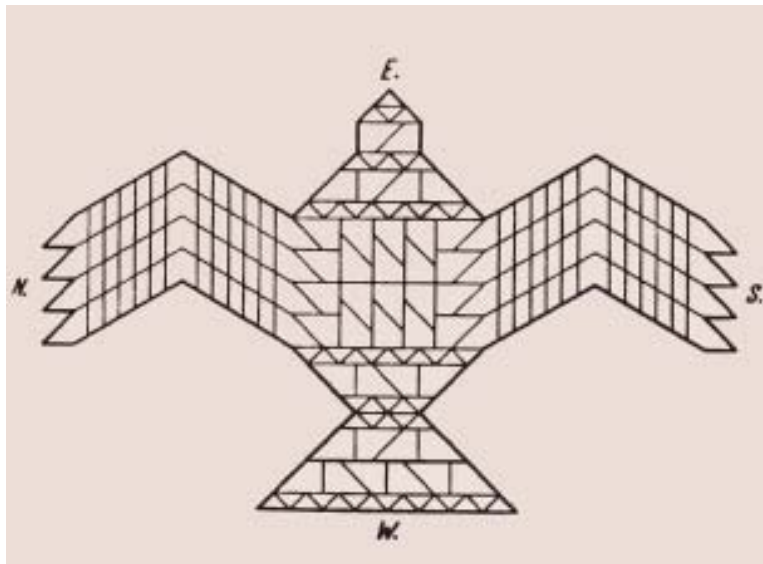

Fig: 3.5: A problem from the Sulvasutras (500 BC): Given an altar in falcon shape having an area of $7\frac{1}{2}$ purushas, to construct an altar of exactly the same shape having an area of $8\frac{1}{2}$ purushas. In the course of construction, a problem arises to construct a square equal in area to a given rectangle. This is solved first by making the rectangle equal to a difference of two squares. Next this difference is made equal to a square by using the 'Pythagoras' theorem. This construction was in all probability known before 600 BC, the time of Pythagoras.

The Post-Vedic Period

The period from 600 BC to 600 AD saw many significant developments in the Indian subcontinent both in science and mathematics. An elaborate atomic theory was developed by **Kanada** around the sixth century BC. The axiomatisation of Sanskrit grammar by **Panini** (c. 350 BC) is the first account of a structural analysis of any language. His work, *Ashtadhyaya*, was among the most influential texts in Sanskrit. Sanskrit was the chosen language for literary, religious, philosophical and scientific discourse.

Ayurveda (a comprehensive system of ancient Indian herbal and mineral medicine) developed as a subsidiary branch of *Atharvaveda*. A monumental treatise on Ayurveda, *Charaka Samhita*, was composed by **Charaka** around the second century BC. Believed to be a revision of **Agnivesa's** work, this contained eight divisions (*ashtanga*), each further divided into several chapters. **Susruta**, an expert in Ayurveda, enriched ancient knowledge by including surgery in his famous treatise, *Susruta Samhita*. The treatise contains descriptions of surgery for cataract, hernia, abdominal ulcers, haemorrhoids, bladder stones, etc., in great detail. There is also evidence of the use of mineral acids during this period. Apart from

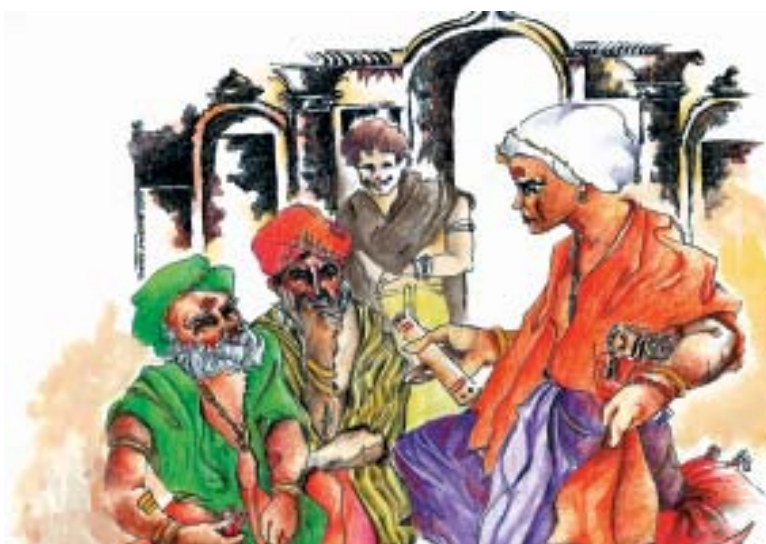

Fig: 3.6: A geometrical proof in the Apastamba Sulvasutra (600-500 BC): One draws a line from the southern *amsa* (D) toward the southern *sroni* (C), to the point (E) which is 12 *padas* from the point (L) of the *prsthya*. There upon one turns the piece cut off (i.e. the triangle DEC) around and carries it to the other side. Thus the *vedi* obtains the form of a rectangle. In this form (FBED) one computes the area.

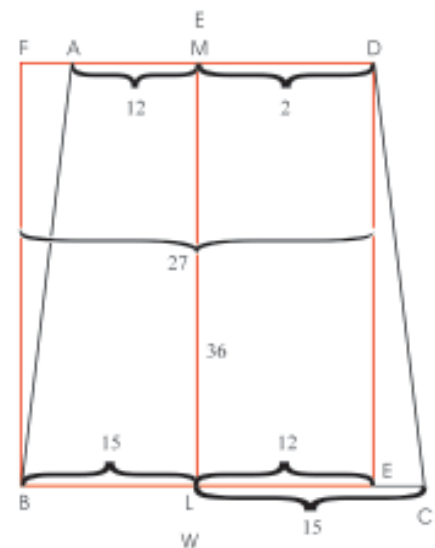

Fig: 3.7: **Aryabhata (476 AD)**: The great mathematician and astronomer worked in Kusumapura near Patna during the Gupta period. His *Aryabhatiya* is considered a mathematical-astronomical masterpiece. He obtained 3.1416 as the approximate value of π . He also gave the correct formulae for the areas of a circle and trapezium and for the sum of an arithmetic series. The modern methods of extracting squareroots and cube-roots are found in his writings. He introduced trigonometric ratios, studied the summation of arithmetic series and quadratic and linear indeterminate equations. He proposed a theory of the rotation of the earth and developed an epicyclic theory for the motions of planets.

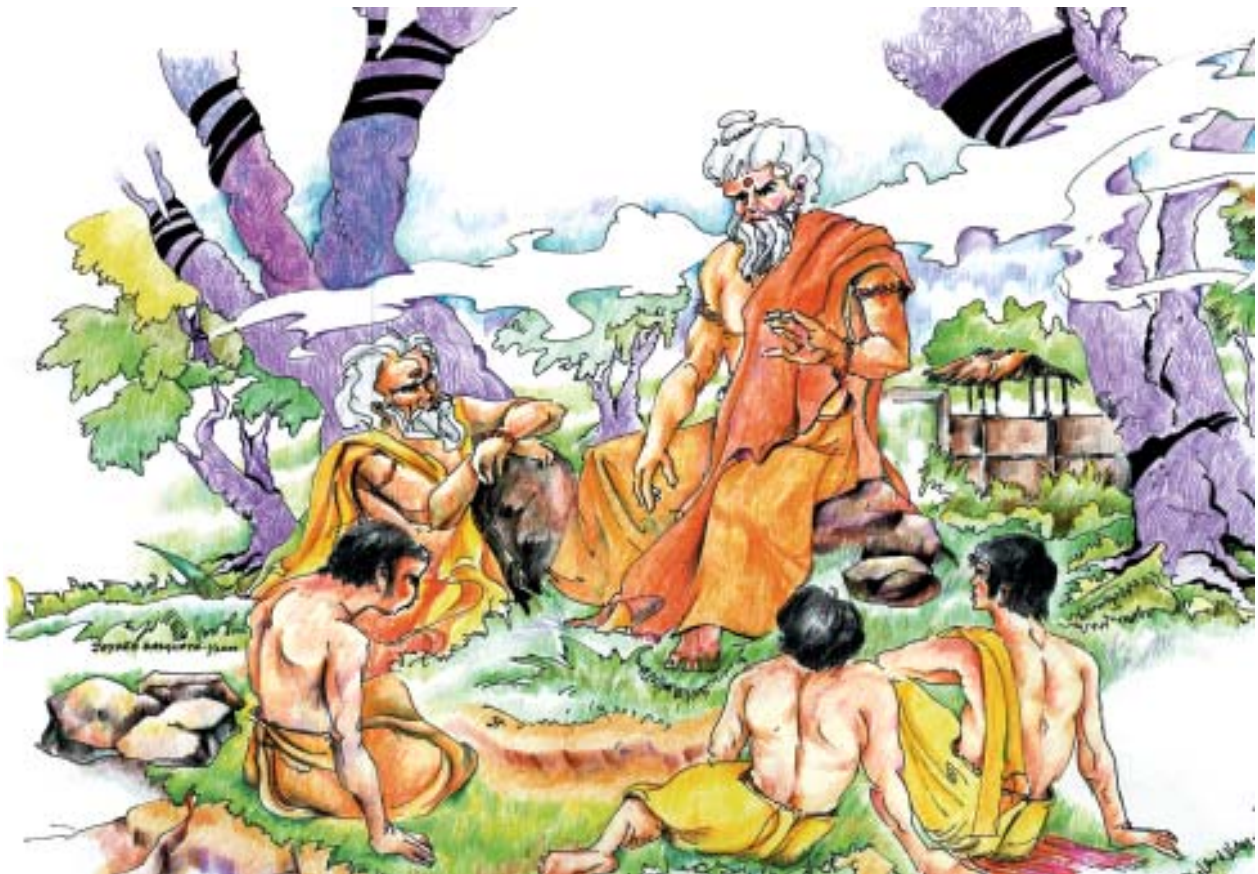

Fig: 3.8: An artist's impression of Charaka teaching the science of Ayurveda to a group of disciples: A basic principle of Ayurveda is that of *tridosha* according to which the equilibrium of the three dosas — *vata* (wind), *pitta* (bile) and *kapha* (phlegm) — keeps a person healthy.

Fig: 3.9: Copper statue of Buddha at Sultanganj (c. 500 AD): The huge statue of Buddha, 7ft. 6in. in height with a weight of one ton, is an example of excellence achieved in metal-working during this period. The statue was discovered by an engineer of East India Company in 1864 and is at present kept in the Museum and Art Gallery of Birmingham.



Susruta's detailed studies in human anatomy, **Parasara's** *Vriksayurveda*, written around first century AD, gives elaborate description and classification of plants.

The emergence of Buddhism and Jainism and the rise of the great empires transcended the Vedic roots of knowledge and spurred new developments. There were several developments in astronomy. The Jaina School (500-200 BC) discussed number theory, permutations and combinations, the binomial theorem, etc. Jaina mathematics also marked a significant change: from being a pursuit aimed at meeting the needs of religious ritual, it became an abstract pursuit in its own right. The *Bakhshali* manuscript (c. 200 AD) describes the eight fundamental arithmetic operations: addition, subtraction, multiplication, division, square, cube, square-root and cuberoot. It was probably during the period 200 AD to 400 AD that the symbol '0' for zero was first used. Other notable developments in algebra were: negative numbers, representation of unknown quantities by symbols, and solutions of simple, simultaneous and quadratic equations.

Atomism

Kanada's world-view is very comprehensive and classifies the entire universe into six broad categories: *Dravya* (Substance), *Guna* (Quality), *Karman* (Action), *Samanya* (Generality), *Visesha* (Particularity), and *Samavaya* (Co-inherence). *Dravya* is further divided into nine categories which includes *Kala* (Time), *Disa* (Space), *Mana* (Mind) and *Atman* (Soul), apart from the typical five elements *Prithvi* (earth), *Apah* (water), *Tejas* (fire), *Vayu* (air) and *Akasa* (ether). The first four elements are made of four distinct kinds of *paramanus* (atoms). According to his atomic theory, combination and separation of the basic *paramanus* gives rise to the diversity of the physical world.

Indian mathematical tradition reached a high level of maturity in the works of **Aryabhata** (b. 476 AD) and **Brahmagupta** (b. 598 AD). Aryabhata not only made great contributions to mathematics and astronomy, but also founded a rich mathematical tradition which continued right down to the Kerala School of the 17th century AD. Brahmagupta's outstanding achievement was the successful solution of indeterminate equations of the second degree (Pell's equation) and the lemmas he discovered in the course of the solution. These discoveries by Brahmagupta and later by **Bhaskara II** had great significance for number theory and were rediscovered by European mathematicians like **Fermat** and **Euler** more than a thousand years later.



Fig: 3.10: An artist's impression of **Susruta performing a surgery**: *Sushruta Samhita* discusses 14 different types of bandages, amputation of damaged limbs, and management of fractures. A pioneering development, which we now call plastic surgery, was used for repairing damaged noses, earlobes, etc. The text describes a large number of surgical instruments that includes 101 blunt instruments (*Yantra*) and 20 sharp instruments (*Sastra*), a few of which are shown above.

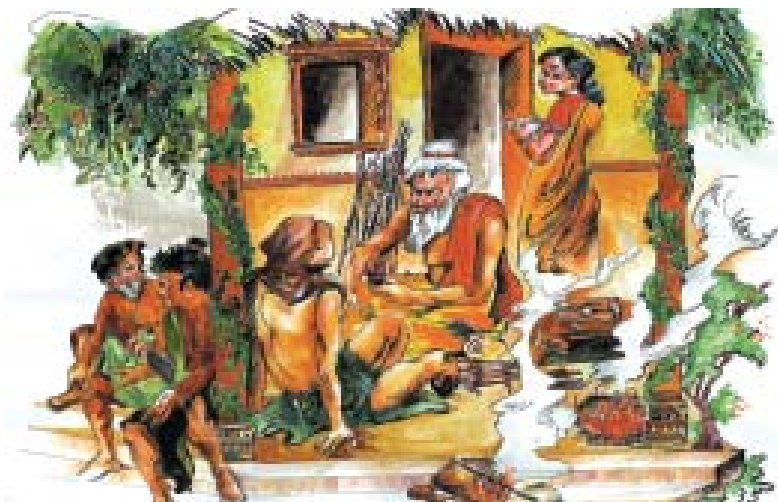

Fig: 3.11: **The Iron Pillar at Delhi (c. 400 AD)**: Located in Mehrauli near Qutub Minar, it has a height of 24ft. 3in. The weight of the pillar is more than six tons. It is made of wrought iron (99.72%) and has not shown signs of wearing away due to rust for more than 1500 years.



Fig: 3.12: **Bakhshali manuscript:** This manuscript was discovered in 1881 in a small village called Bakhshali near Peshawar, now in Pakistan. It belongs to the 3rd and 4th century AD and gives rules for arithmetic, algebraic and geometrical operations with illustrative examples and solutions. The manuscript uses the decimal place value system and the symbol for zero. It also has the first recorded use of the sign for negative numbers.

Bhakshali Manuscript

$\begin{array}{ c c } \hline 11 \\ \hline \\ \hline \end{array}$	yu	$\begin{array}{ c } \hline 5 \\ \hline \\ \hline \end{array}$	mu	$\begin{array}{ c } \hline 4 \\ \hline \\ \hline \end{array}$	means	$\sqrt{11 + 5} = 4$						
$\begin{array}{ c c } \hline 11 \\ \hline \\ \hline \end{array}$	7+	$\begin{array}{ c } \hline \\ \hline \\ \hline \end{array}$	mu	$\begin{array}{ c } \hline 2 \\ \hline \\ \hline \end{array}$	means	$\sqrt{11 - 7} = 2$						
$\begin{array}{ c } \hline 0 \\ \hline \\ \hline \end{array}$	5	$\begin{array}{ c c } \hline \\ \hline \\ \hline \end{array}$	yu	$\begin{array}{ c c } \hline \\ \hline \\ \hline \end{array}$	mu	$\begin{array}{ c } \hline 0 \\ \hline \\ \hline \end{array}$	sa	$\begin{array}{ c c } \hline 0 \\ \hline \\ \hline \end{array}$	7+	$\begin{array}{ c } \hline \\ \hline \\ \hline \end{array}$	mu	$\begin{array}{ c } \hline 0 \\ \hline \\ \hline \end{array}$
which means												
$\sqrt{X + 5} = S$						and						$\sqrt{X - 7} = t$

The Medieval Period

Besides the significant contributions in mathematics, astronomy, linguistics and philosophy, Indian contributions to metallurgy need special mention. The pre-eminence of India in making high quality steel for swords is well known. Apart from the marvels such as the Iron Pillar at Delhi and the copper statue of Buddha at Sultanganj, later developments in metallurgy gave rise to methods of extracting new metals. Recent archaeological findings at Zawar near Udaipur in Rajasthan have thrown light on the extraction of zinc on an industrial scale in the medieval period. Indians were probably the first to master this difficult metallurgical technique (around 1150 AD) which involved condensation of the vapours of the metal.

Fig: 3.13: **Lilavati**, Bhaskara II's daughter (after whom his book is named). She and her fiancé are trying to determine a chosen moment of time by observing the slow sinking of a small vessel (*ghatika*) in a tray full of water. According to the legend, a pearl from Lilavati's jewellery blocked the hole in the *ghatika* making the observers lose track of time.





Fig. 3.14: **Zawar**: The archaeological excavation at Zawar (Rajasthan) in 1983 brought to light the remains of furnaces that were used for the distillation of zinc to produce brass in the period 1150-1810 AD. The furnace had a zinc condensation chamber at the bottom and a furnace chamber at the top separated by perforated terracotta plates. Above these plates, 36 charged retorts were arranged vertically to collect the condensed zinc vapour. Extraction of zinc was mastered and undertaken on an industrial scale. Furnaces of this kind are described in *Rasaratnasamuccaya* in great detail. It is likely that the first process patented in 1748 by **William Champion** involved a transfer of technology from India.

Spinning, weaving and dyeing cotton textiles were some other skills in which Indians excelled.

Mathematics continued to be pursued by Indian scholars of this period. **Mahavira** (850 AD) systematized the work of Jaina mathematicians and gave general formulae for permutations and combinations. **Sridhara** (991 AD) gave a general method of solving quadratic equations of the type $ax^2 + bx = c$ by multiplying both sides by $4a$ and completing squares. **Bhaskara II** (1114 AD) represented a high period of Indian mathematics. He improved **Brahmagupta's** solution of **Pell's** equation by discovering the *chakravala* (cyclic) method, later discovered by Fermat as the method of infinite descent. He also gave all the correct operations with zero including division by zero, and operations with negative numbers. Another remarkable achievement is the idea of infinitesimal increase and the derivative which are implicit in his discussion of instantaneous velocity of a planet. He also wrote down the equivalent of $d(\sin x) = (\cos x)dx$.

Fig. 3.15:



Fig: 3.16: **Alchemy:** Alchemy in India was more concerned with life-prolonging processes than with the conversion of base metals into noble ones. Alchemical texts of India describe the various products used for medicinal purposes. A laboratory would be located in a place rich in medicinal herbs, and had a variety of apparatus made of earthen material. High temperature was achieved by feeding dried cow-dung cakes for several days at a stretch. The picture is an artist's impression of a *rasasala* reconstructed from **Rasaratnasamuccaya** (1300-1500 AD). In the centre of the picture is an apparatus, *kosthiyantram* in which mercury is being heated.



The great contributions made by the Kerala School of mathematicians have recently come to light showing that the high period of Indian mathematics extended well beyond Bhaskara II. The Kerala School had a series of distinguished mathematicians from **Madhava** (1340-1405 AD), **Parameshwara**, **Damodara** and **Neelakanta Somayajin** (1442-1540 AD), to **Jyesthadeva** (1500-1610 AD). The most outstanding contribution of this School is the elaboration of the power series expansions for $\sin x$, $\cos x$ and $\tan^{-1} x$, which fully anticipated European discoveries by nearly three centuries. Madhava also gave a series to obtain a rational approximation to to any needed accuracy.

The Notion of Impetus in Nyaya-Vaisesika

*When a body experiences a force, a quality of **vega** (impetus) is possessed by it; and as a result the body continues to move in the same direction; and when it encounters an obstacle, it would come to rest or continue its motion with diminished strength.*

This notion of impetus as defined in the *Nyaya-Vaisesika* system of thought is a clear forerunner of the notion developed much later in Europe. It may be noted that the concept is defined as a quality and not as a measurable quantity, unlike the later western concept. *Nyaya-Vaisesika* is a well developed and fairly dominant Indian school of thought, that professed an atomic world view. The school was founded by **Goutama** and **Kanada** sometime between 200 - 400 AD, and continued to develop till the medieval period.

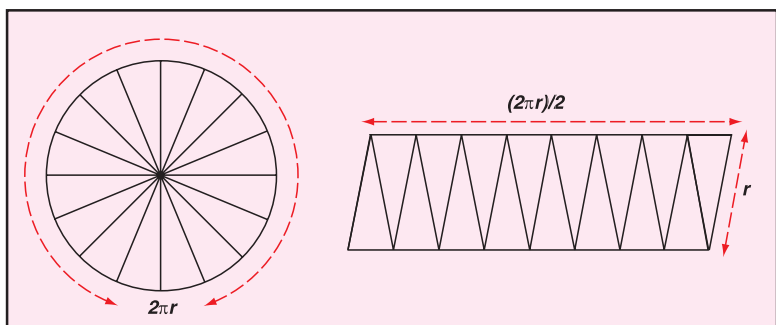

Fig: 3.17: The familiar proof of the formula for the area of a circle is found in **Ganesa's** work.

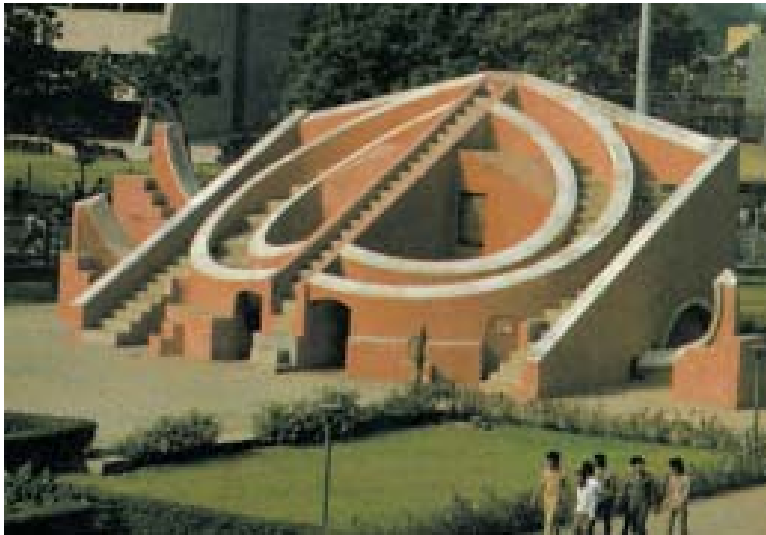

Fig: 3.18: The huge concrete astronomical observatories built by Raja Savai Jai Singh II of Jaipur. An important landmark of astronomy in the medieval period was the building of observatories. Maharaja Sawai Jai Singh II of Jaipur, a great lover of astronomy, set up five observatories, at Delhi (Jantar-Mantar), Ujjain, Banaras, Mathura and Jaipur. Massive instruments like dials, hemispherical dials, zodiac dials were built in these observatories. Extensive observations were recorded in astronomical tables, published both in Persian and Sanskrit.

Write the product of the column digit and row digit in each cell in the table in the lower right hand corner.

	1	3	5	
2	2	6	10	2
3	3	9	15	3

If the product has 2 digits, the second digit must be written in the upper left hand corner.

	1	3	5	
2	2	6	10	2
3	3	9	15	3

Now add the numbers diagonally from right to left to obtain the product. The product is 3105.

	1	3	5	
2	2	6	10	2
3	3	9	15	3

3 1 0 5

Fig: 3.19: Gelosia method: A method of multiplication as it appears in Ganesa's work (c. 1545). To multiply 135 by 23, one constructs a table of 3 columns and 2 rows (corresponding to the 3 digits of 135, and 2 digits of 23).

Pell's Equation
or
The Brahmagupta-Bhaskara Equation

$$DX^2 + 1 = Y^2$$

<p>Example 1 (Brahmagupta)</p> $67X^2 + 1 = Y^2$ <p>X = 5967 Y = 48842</p>	<p>Example 2 (Bhaskara)</p> $61X^2 + 1 = Y^2$ <p>X = 226153910 Y = 1766319049</p>
--	---

Fig: 3.20: The method to solve an indeterminate equation of the second degree, i.e. $DX^2 + 1 = Y^2$ was given by Brahmagupta (598-668 AD) and was later perfected by Bhaskara (1114-1185 AD) by using the Chakravala (cyclic) method. Euler, in the 17th century, mistakenly attributed the equation to Pell, having found it in his works.

4

Science in Ancient China

Chinese World View

A large land mass of near-continental size with diverse climates and a vast population, China developed into a great and distinctive culture. Ancient Chinese were avid observers of nature, and made significant advances in several areas of science, mathematics and technology. From the 16th to 11th century BC, during the Shang dynasty, a fully developed 'Bronze Age' culture flourished in China. The Chinese mastered metallurgy much earlier than other civilizations. They also had several kinds of decimal numeral systems starting from 1500 BC, as seen on the oracle bones. The modern Chinese numerals appeared first in the third century BC.

Confucianism and Taoism are the two main philosophical strands underlying the Chinese culture. Confucius regarded human beings as endowed with a spirit of justice, and concentrated on preaching universal education, harmony and justice in social relationships. Taoism, in contrast, preached human beings to live a natural way of life by obeying natural order, and not by trying to gain mastery over it. This philosophy was mainly responsible for encouraging a

Fig. 4.1: K'und Fu Tzu or Confucius (5th century BC) preached individual and universal education and held that the administrative positions should go to educated academics. Though Confucius concentrated mostly on social organization, he developed an abstract system of 'ladder of spirits' depicting different levels of life, as shown in the picture. Fire and water (the bottommost level) had a subtle spirit, but not life; plants and trees (the second level) had life spirit but not perception; birds and animals (the third level) could perceive, but it was only man (occupying the topmost level) who had a spirit of justice.





Fig. 4.2: **The Great Wall of China**, about 2,400 km long and 9 m high at most places, represents one of the largest building projects ever undertaken. It was built during 453-221 BC when a number of small defensive structures were built in the Warring States Period. In 221 BC, Ch'in Shih Huang Ti (Di), the first Emperor of China, connected these, extending the Wall from the Liaoning Province in the east to central Asia in the west. Originally, the structures were built of masonry and earth, with brick faces in some portions. The Wall stands as a testimony to the engineering genius of the Chinese.

highly detailed study of nature. The Taoist world view was distinctly organic and viewed everything in nature, including human beings, as a part of a grand interconnected system. Apart from these two dominant schools, there were the Mohists and the Logicians who explored experimental science, cause and effect relationship, and logic — encompassing deduction, induction, conceptual models and paradoxes.

The most outstanding contribution during the Han dynasty was *I Ching* (The Book of Changes), composed around the third century BC. The book contains a highly abstract description of Nature, and describes a theory of five elements (water, metal, wood, fire and

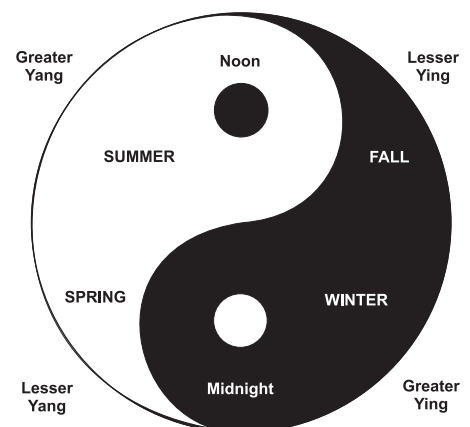
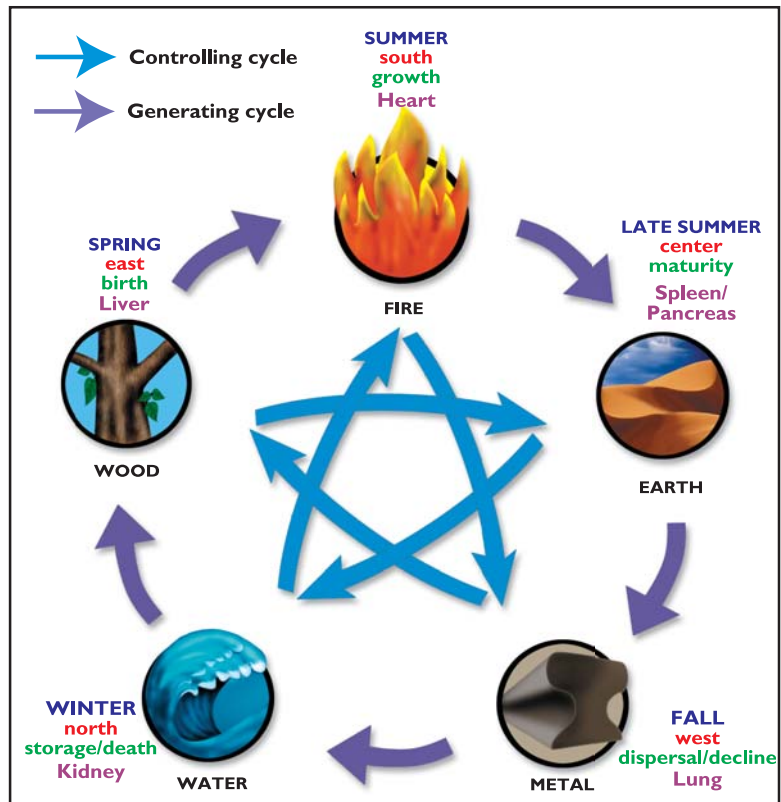

Fig. 4.3: Chinese outlook viewed the world as a process of growth and decay of the two forces, **Yin** and **Yang**. It was essentially a cyclic view, where the things and events permeating the universe undergo wave-like changes wherein objects grow and decay.

Fig. 4.4: **The Five Element Theory:** Tsou Yen (270 BC) systematized the five element theory, according to which, water, metal, wood, fire and earth were the five active elements, each with a corresponding taste: salt, acrid, sour, bitter and sweet. The elements were interrelated by the cyclic processes of 'becoming', 'producing' and 'conquering'. The blue arrows in the picture, represent conquest: wood conquers earth (wooden spade can dig up earth); metal conquers wood (metal can cut and carve wood); fire conquers metal (fire can melt metal); water conquers fire (water can extinguish fire); and earth conquers water (earth can dam water by containing).



earth). These elements were then systematically associated with the two fundamental forces — the *Yin* and the *Yang*. The elements and the forces were thought to generate the multiplicity of the substances and changes in the world. The theory seemingly threw light on every observed fact of Nature and the book became a natural reference for every scholar. The all encompassing character of the book had a major impact on the Chinese civilization, comparable to the impact of the Vedas in India.

Fig. 4.5: Buddhism entered into China from India around the first century AD. Its encounters with Taoism and Confucianism resulted in a special form of Chinese Buddhism, which had a deep influence on Chinese thought and culture.



THE CHINESE ELEMENTS & ASSOCIATIONS					
Elements	木 Mù WOOD	火 Huǒ FIRE	土 Tǔ EARTH	金 Jīn METAL	水 Shuǐ WATER
Colors	Blue/green	Red	Yellow	White	Black
Symbols	Dragon	Phoenix	Caldron	Tiger	Tortoise
Seasons	Spring	Summer	Between	Autumn	Winter
Months	1-2	4-5	3,6,9,12	7-8	10-11
Conditions	Rain	Heat	Wind	Clear	Cold
Directions	East	South	center	west	north
Mountains	Tai, Shantung	Heng, Hunan	Sung, Honan	Hua, Shensi	Heng, Hopei
Planets	Jupiter	Mars	Saturn	Venus	Mercury
Days	Thursday	Tuesday	Saturday	Friday	Wednesday
Animals	Scaled	Winged	Naked	Furred	Shelled
Peoples	Mongol	Hin	Manchu	Tibetan	Hu/Turks
Actions	Countenance	Sight	Thought	Speech	Listening
Senses	Sight	Taste	Touch	Smell	Hearing
Sounds	Calling	Laughing	Singing	Lamenting	Moaning
Notes	chiao/kaku/E	chih/chi/G	kung/ky B/C	shang/shū/D	yū/ū/A
Tastes	Sour	Bitter	Sweet	Acrid/spicy	Salty
Smells	Goatish	Burning	Fragrant	Rank	Rotten
Organs	Liver	Heart	Spleen	Lungs	Kidneys
Virtues	Benevolence	Propriety	Good faith	Righteousness	Knowledge
Emperors	Fu-hsi	Shen-nung	Huang-ti	Shao-hao	Ch'i an-hsü
	T'ai-hau	Yen-ti	Huang-ti	Shao-hao	Ch'i an-hsü
Ministers	Chi-mang	Chi-jung	Hou-t'u	Jung-shou	Hsü an-ming
OTHER CHINESE FIVES, ASSOCIATIONS UNCERTAIN					
Metals	Iron	Copper	Gold	Silver	Tin
Relations	Ruler	Father	Husband	Elder	Friend
	Subject	Son	Wife	Younger	Friend
Poisonous animals	Snakes	Toads	Lizards	Scorpions	Centipedes
Grains	Barley/wheat	Rice	Millet	Corn [millet]	Beans
Spirits	Mind	Soul (hun)	Spirit	Soul (p'ie)	Will
Punishments	Death	Life exile	Exile	Detention	Fines

Fig. 4.6: The elaborate system of generating a multitude of phenomena by associating them with the five elements.

Mathematics and Astronomy

The Chinese began to use nine numerals with a placevalue principle around the fourteenth century BC. They were adept in handling fractions and negative numbers, and were also able to handle very large numbers. Possibly, the concept of negative numbers appeared in China around the second century AD, much before it did in India. The Chinese were also famous for developing devices for calculation, such as counting rods and abacus. The oldest available document of ancient Chinese mathematics **Chou Pei Suan Ching** (fourth century BC) contains a proof of the **Kau Ku** theorem (Pythagorean theorem). Though the Chinese had no general theory of equations, by the Han period (200 BC to 220 AD), they were able to solve simultaneous linear equations with several unknown quantities, indeterminate equations and quadratic equations. They had no symbols for algebraic equations, but they used counting-rods (see picture). They also developed numerical methods of solving higher order equations. Pascal's triangle of binomial coefficients was known to them as early as 1100 AD, about five centuries before Pascal.

Fig. 4.7: **Proof of the Kou Ku ('Pythagorean') Theorem:** ABC is a space for a rightangled triangle. BCIS is the square on the **kou** (or a) while AQDC (=FERI) is the square on the **ku** (or b). From SBCFER cut off the triangle GBS and put it in the space ABC. Next, cut off the triangle EGR and place it over the triangle EAF. What we now have is the square AEGB, which is the square on the hypotenuse (or c). This completes the 'proof' of the **Kou Ku** theorem.

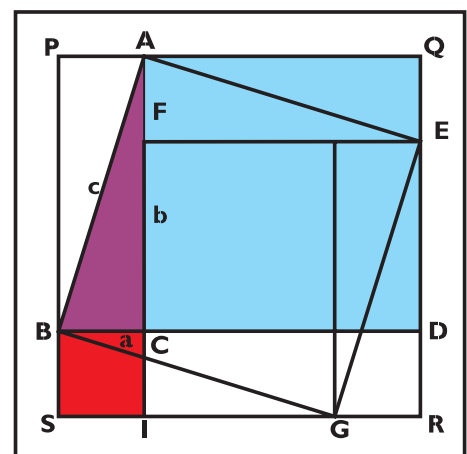



Fig. 4.8: Modern astronomers go back to Chinese records to trace astronomical events e.g. a comet's earlier movements. Star catalogues were prepared in China starting from fourth century BC.

The Chinese belief that everything in the cosmos was interconnected provided a motivation for their meticulous observation of the heavens as well as nature. Chinese astronomical observations are found to be of considerable use today by the astronomers because many astronomical events of the ancient times were recorded by them. Their records go back to 720 BC and are reliable and detailed. They recorded observations on 75 guest stars (nova or supernova) between 352 BC to 1604 AD. They used a projection method for displaying the celestial sphere on the two dimensional surface, which was similar to the projection developed almost six centuries later by Gerhard Mercator in the West in 1596. The Chinese followed a luni-solar calendar. By 1400 BC they knew that the solar year was $365 \frac{1}{4}$ days and the new moon appears every $29 \frac{1}{2}$ days. They also developed many astronomical measuring instruments such as armillary spheres and gnomon. Their time keeping instruments had undergone a major advancement by using escapement mechanism, almost seven hundred years before mechanical clocks were developed in the West.

Fig. 4.9: Simultaneous Equations with Counting Rods: The counting rods were arranged in such a way that one column was assigned to each equation, and one row to the coefficients of each unknown in the equations. The elements of the last row consisted of the entries on the right-hand side of each equation. Red rods represent positive (*cheng*) coefficients and black rods negative (*fu*) coefficients. Such simultaneous equations appeared in *Chiu Chang Suan Shu* (Nine Chapters on the Mathematical Arts) of c. 300 BC to 200 AD, composed by an unknown author. This is one of the most influential mathematical texts of ancient China.

			$2x$	$-6x$	$3x$
			$-3y$	$-2y$	$-21y$
			$+8z$	$-z$	$-3z$
			$= 32$	$= 62$	$= 0$

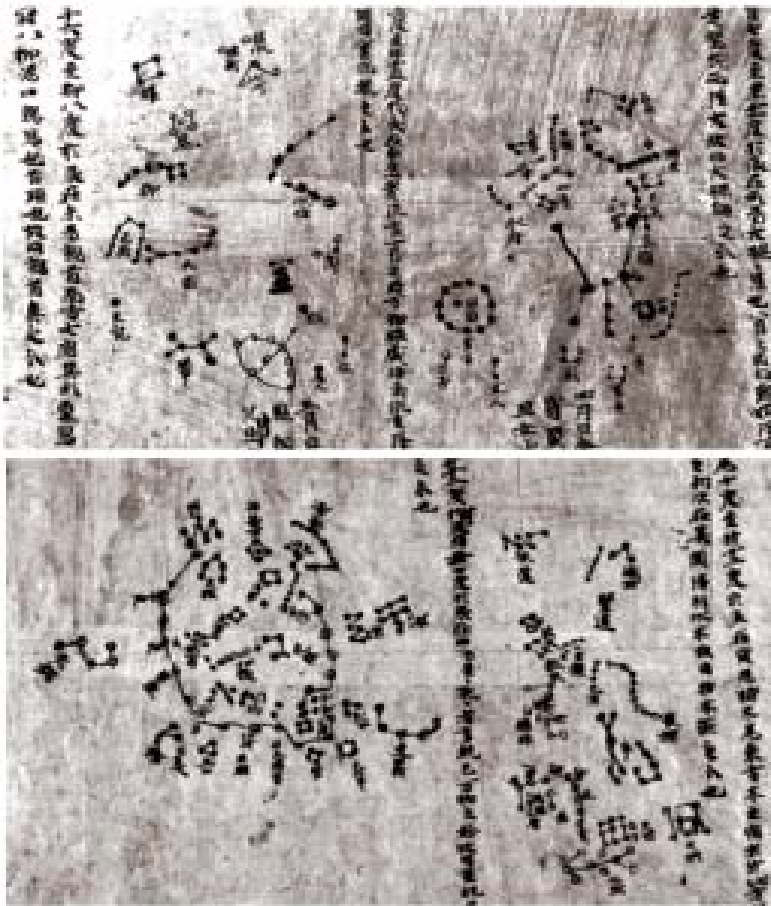

Fig. 4.10: The 'Tunhuang' star-map of Ch'ien Lo-Chih of 940 AD. The map uses a 'Mercator' projection. Current atlases and maps use this method, commonly attributed to the Flemish cartographer, Gerhard Mercator in 1596. The West's priority to this method is certainly misplaced for it is nearly 600 years after the Tunhuang star-map.



Fig. 4.11: An illustration of crude integration drawn by one of Seki Kowa's pupils, displaying the method of measuring the area of a circle with a series of rectangles. Seki Kowa was a 17th century Japanese mathematician.

Fig. 4.12: **Armillary Sphere:** It is a sphere of rings representing a skeleton of the celestial globe. The rings are often graduated for measuring the positions of stars.

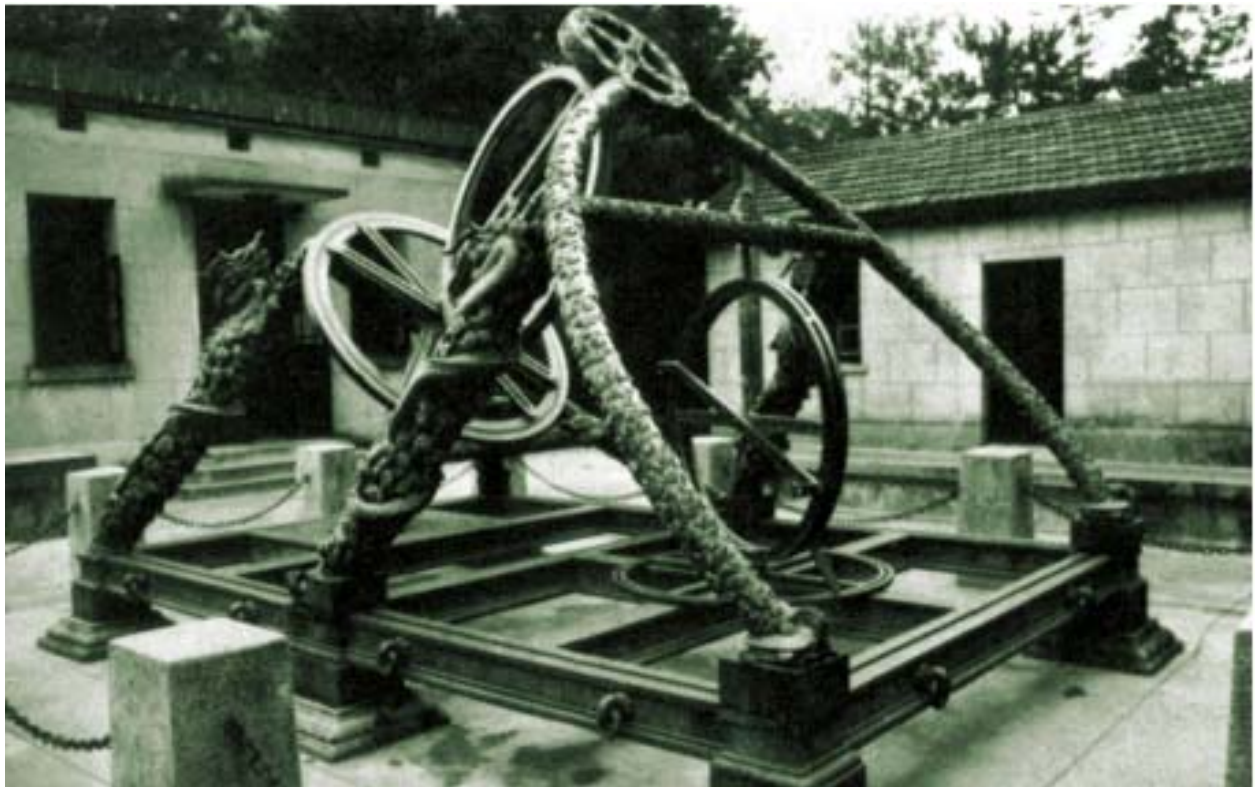

Fig. 4.13: **Suan p'an (Calculating Plate) or Chinese Abacus:** This is an evolved version of the original 'ball arithmetic,' which appeared first in a book of the sixth century AD.

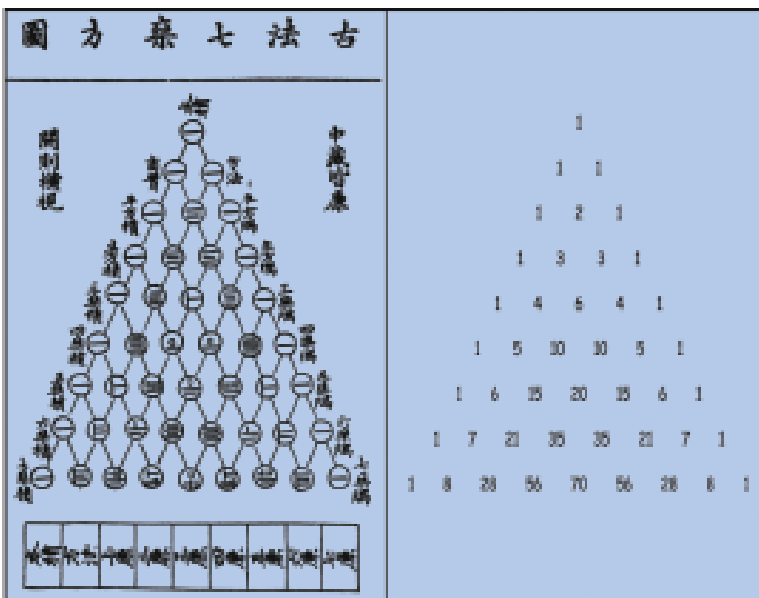

Fig. 4.14: **The Pascal Triangle** for $n = 0, 1, 2, \dots, 8$ depicted at the beginning of Chu Shih Chieh's book *The Precious Mirror of the Four Elements*. Chu also indicated how the triangle can be used for obtaining solution of numerical equations of higher order. The picture on the right is a transliteration in modern numerals. In modern terminology, the picture reads as follows: The numbers in the $(n+1)$ th row show the coefficients n of the binomial expansion of $(a+b)^n$, n being a positive integer. The unit coefficients along the extreme left slanting line (the *chi shu*) and the extreme right slanting line (the *yu suan*) are the coefficients of the first and last term respectively in each expansion. The inner numbers, '2', '3,3', '4,6,4',... on the third, fourth and fifth, etc., rows (the *lien*) are the inner terms of the binomial equations of the second, third, fourth, etc., Degree.



Fig. 4.15: A Chinese mariner's compass of the 19th century.

Natural Sciences

Along with their records of astronomical events, the Chinese also had records of rainfall, snowfall and the directions of wind. By measuring and comparing the weights of dry and wet charcoal they developed a hygrometer (to measure the water content of the air) in the second century BC. They had found and studied several fossils and their biological origins. They did 'geo-botanical prospecting' of ores: a method of locating the place where ores could be found by geological and biological indicators. They kept extensive records of all major earthquakes, the earliest one in 780 BC. Around the second century AD Chang Heng invented the first ever seismograph, 'the earthquake weathercock'.

A significant Chinese contribution to technology was the invention of magnetic compass. This instrument first appeared in the third

Fig. 4.16: A fortune teller's divining board was the precursor of the magnetic compass. The 'spoon,' made of lodestone, always pointed to the south pole. By the first century AD, the Chinese started designing and using lighter magnetic objects like thin needles mounted on wood. They used the compass first in civil engineering and by the tenth century began using it for navigation.



century BC as diviner's boards for fortune telling. The Chinese also discovered that the magnetic north/south does not coincide with the geographical north/south. Their experiments with weak nitric acid brought them in contact with potassium nitrate (saltpetre) which led them to the discovery of gunpowder. They used gunpowder for fireworks and for military purposes starting from the tenth century. It was only during the thirteenth century that its use spread to the Arabian world and subsequently to Europe in the fourteenth century. There are many other notable Chinese achievements such as chemical preservation of human bodies; study of mirrors and lenses and their use for practical purposes; development of metallurgical apparatus and the use of distillation process for extracting metals; biological plant protection; traditional silk industry; a system of healing called acupuncture; invention of movable type and printing press; paper making, etc.

The Chinese civilization thus has a distinguished record of contributions to mathematics, astronomy, science and technology that pre-empted the West in many areas. To what extent their discoveries actually influenced the rise of Western science is, however, not very clear.



Fig. 4.17: The earliest known seismometer, a device for registering seismic activity, was designed by **Chang Heng** in 132 AD. It enabled him to announce the occurrence of a major earthquake, nearly 400 km away from the capital, days before the messengers on galloping horses brought the news of devastation.



Fig. 4.18: **Acupuncture**: A method of treatment that has survived from 600 BC till today. Chinese physicians identified specific points below the skin, called acupuncture points, along twelve lines through which 'vital' energy flowed in the body. Chinese traditional medicine is a combination of herbal treatment, acupuncture and moxibustion (burning a herb called moxa on an acupuncture point).

Fig. 4.19: Processing of Silk Processing of Silk





Fig. 4.20: **Alchemy in China:** The Chinese invented several extraction and separation techniques. They invented freezing-out process for producing a very concentrated alcohol, probably in the second century AD. They used specially designed stills in their alchemical laboratories before the fourth century AD. By the seventh century, distillation process was widely practised. The picture shows an alchemist's laboratory with a still used for distillation.

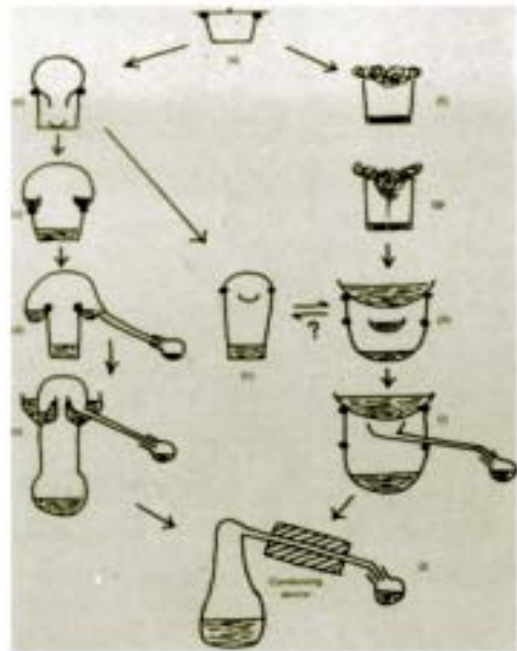

Fig. 4.21: **The evolution of the still** as captured in a conjectural drawing by Joseph Needham. The rich traditions of science and technology in China became known to the rest of the world only in the 1960s, through the scholarly works of Joseph Needham, followed by several other scholars.

Fig. 4.22: **Su Song's Clock** was built between 1088 and 1092. It had three rotating instruments: the clock, a celestial globe and an armillary sphere. All the three instruments worked in coordination with each other, driven by a single water-powered mechanism. Most notable in this engineering feat is the first appearance of an escapement mechanism for any clock.

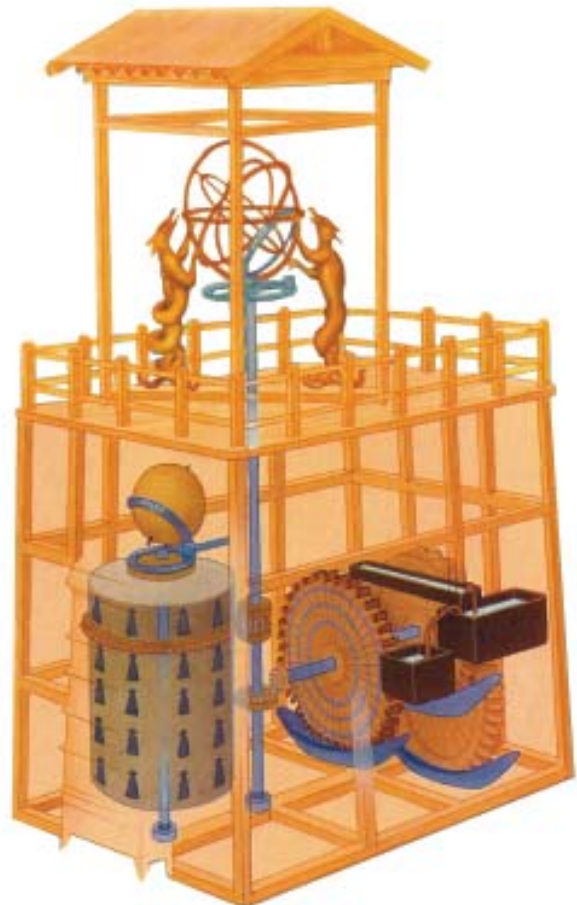
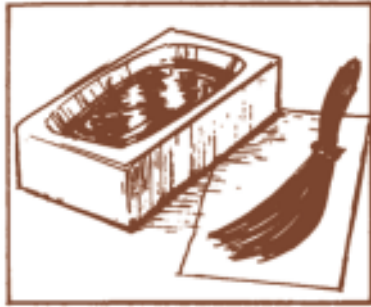

Fig. 4.23: The printing technique devised by the inventor **Bi Sheng** in the 1040s was the world's first movable type system.



To print with movable type, a brush was used to mix solid ink and water in a shallow rectangular dish.



A sheet of paper was placed over the inked characters and rubbed down gently with a pad.

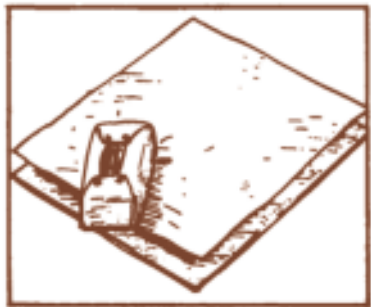

The paper was peeled away, to reveal the impression of the inked characters printed on it.

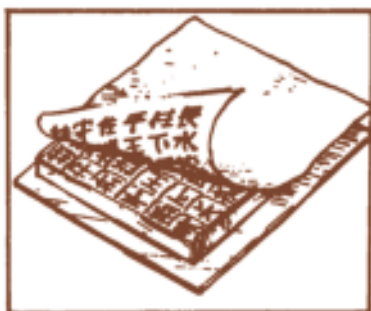

Fig. 4.25: **Paper making** was invented by Ts'ai Lun in 105 AD. He prepared a pulp of mulberry bark, hemp and rags with water, squeezed out the liquid by pressing to form a thin mat, and dried it in the sun. Around the seventh century, the technique spread to Japan, where it flourished and developed. In 751 AD, during the Samarkhund war, the Arabs took the Chinese papermakers as prisoners. From Arabia it went to Europe through Spain in 1009 AD. The picture shows an artist's impression of an ancient Chinese paper industry.

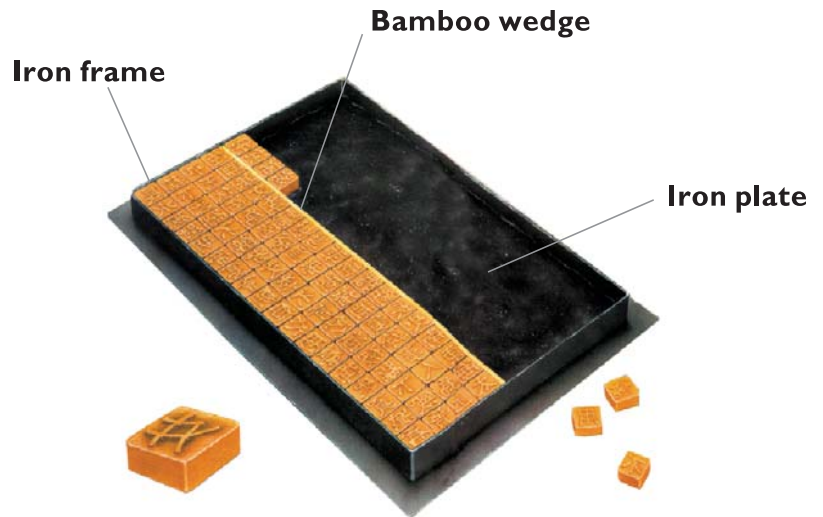

Fig. 4.24: **Making of Artificial Magnets:** The Chinese discovered around the sixth century that small iron needles could be magnetised by stroking them with a piece of lodestone. By the eleventh century, they had developed the technique of magnetising iron by raising it to red heat and then cooling it while it was held in a north-south direction.



5

Science in West Asia

Astronomy and Mathematics

After the decline of Greek Science, Europe passed through a millennium in which theology was the primary concern and science took a back seat. In contrast, following the Islamic conquest of western Asia and northern Africa, there was spectacular progress in Arabian Science from about 700 AD to 1200 AD. Abbasid caliph's ambitious cosmopolitan institute, *Bait al-Hikma* ('House of Wisdom'), was an intellectual centre of the Arab world for more than 200 years. It had scholars who translated scientific works from Sanskrit, Pahlavi, Syriac and Greek into Arabic. The broadminded and influential philosopher **al-Kindi** (born c. 801) studied and encouraged learning from all sources within the 'House of Wisdom'.

Arabian mathematics was a blend of Babylonian, Indian and Greek mathematical traditions. After the seventh century, when Abbasids came to rule Baghdad, Indian numerals and astronomical texts came to Arabia. **Severus**, a Syrian bishop, wrote in praise of Indian numerals, but they were not widely accepted till **al-Khwarizmi** promoted their use. A systematic beginning was made to synthesize geometry and algebra by al-Khwarizmi and **Omar Khayyam** (1044-1123), who gave geometric solutions to quadratic equations and cubic equations. Omar extended the concept of a number to include positive irrational numbers. It is believed that the idea passed through **al-Tusi** (1201-74) to European mathematics.

Al-Battani (858-929) was the first to replace the use of Greek chords by Sines, an idea believed to have come from the Indian astronomical texts. **Abul Wafa** (940-998) did pioneering work in trigonometry by using Tangent function, compiled tables for Sines and Tangents and introduced the secant and cosecant functions. **Al-Hasib** (c.850)

Fig 5.1: Al-Khwarizmi (c.780-850)



Al-Khwarizmi reduced all algebraic equations into six types. The unknown quantity was referred to as 'roots' and the constants as 'numbers'.

1. Roots equal squares: $bx = ax^2$
 2. Roots equal numbers: $bx = c$
 3. Squares equal numbers: $ax^2 = c$
 4. Squares and roots equal numbers: $ax^2 + bx = c$
 5. Roots and numbers equal squares: $bx + c = ax^2$
 6. Squares and numbers equal roots: $ax^2 + c = bx$
- where a , b and c are positive integers.

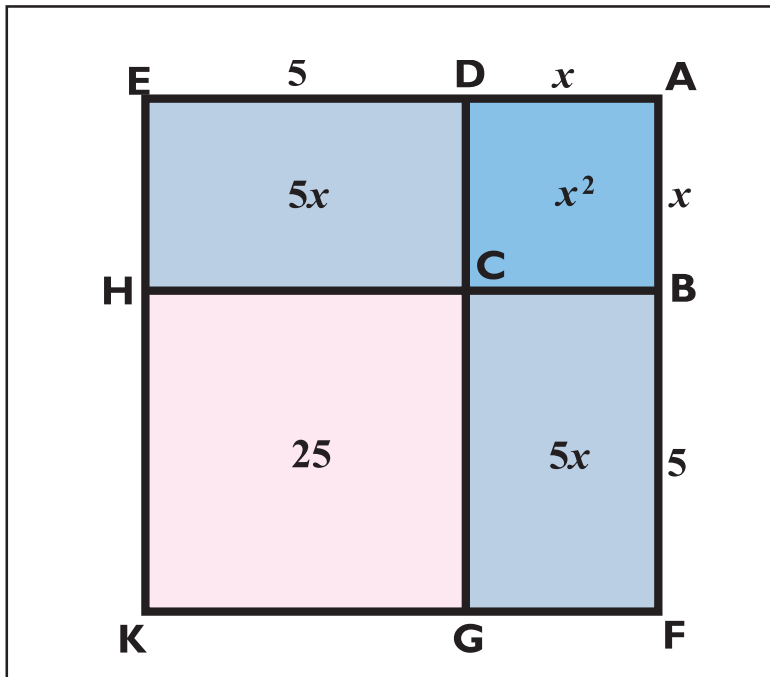

Fig 5.2: Al-Khwarizmi geometric solution of a quadratic equation: ABCD is a square of side x . AD and AB are extended to E and F such that $DE = BF = 5$. The square AFKE is completed, and DC is extended to G and BC to H. Then the area of AFKE is equal to $x^2 + 10x + 25$, or $(x + 5)^2$. Adding 25 to both sides of the equation $x^2 + 10x = 39$ gives $x^2 + 10x + 25 = 39 + 25 = 64$ from which one of the sides of AFKE, say EK is found to be $x + 5 = 8$, and so $EH = x = 3$.

extended the work by constructing the first sine and tangent tables at intervals of 1 degree, accurate to three sexagesimal (nine decimal) places. The astronomer **Ulugh Beg** (1394-1449) reduced the intervals and increased the accuracy of these tables. **Al-Kashi** (c. 1380-1429), a brilliant mathematician, calculated the value of π to sixteen decimal places, wrote an exposition of decimal fractions and calculated trigonometric values to nine sexagesimal (sixteen decimal) places. Both trigonometry and algebra developed by the Arabian mathematicians played a direct and significant role in the scientific revolution in Europe. Their role in passing the Indian numerals to the whole world is, of course, well known.

The Arabs made careful observations of the sky and drew detailed celestial maps. Their need to establish the correct coordinates of cities so that they could determine the direction of Makkah for prayer provided motivation for a difficult problem to solve. With the establishment of observatories and the influx of Greek astronomical texts, serious development of indigenous Islamic astronomy coupled with advances in mathematics began to take place. Preparation of

Fig 5.3: Solving the equation: mal and 10 root equals 39 (in modern notation $x^2 + 10x = 39$)

AL-KHWARIZMI'S EXPLANATION	EXPLANATION IN MODERN NOTATION
1. You halve the number of roots: Result 5.	$x^2 + 10x = 39$
2. This you multiply by itself: Result 25.	
3. Add this to 39: Result 64.	$(x + 5)^2 = 39 + 25 = 64$
4. Take the square root of this: Result 8.	$x + 5 = 8$
5. Subtract from 8 the result given in Step 1: Result 3.	$x = 3$

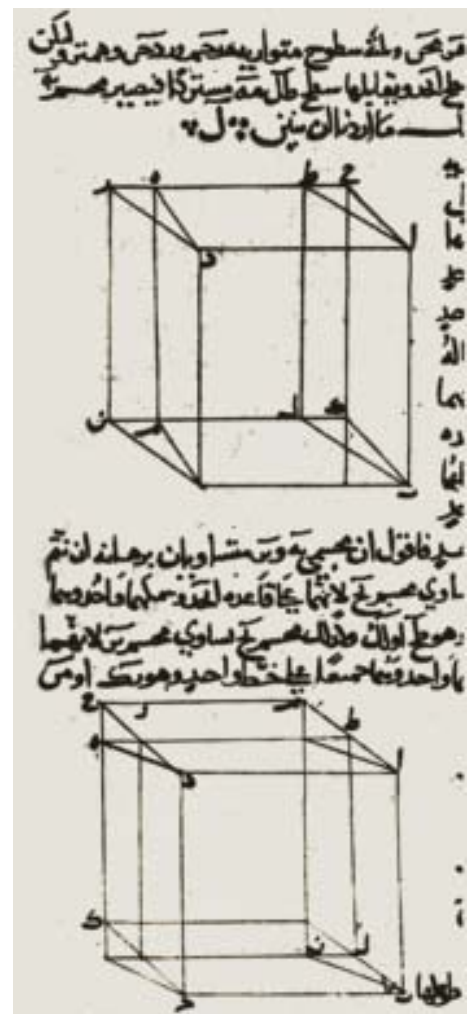

Fig 5.4: The illustration depicts a 9th century manuscript of Euclid's Elements in the version revised by **Thabit ibn Qurra** (826-901). Ibn Qurra was the first great Arab mathematician. Well versed in Greek, Syriac and Arabic, he made many contributions in mathematics. As a translator he wrote Arabic editions of all the works of Archimedes and the work of Apollonius on conic sections as well as Euclid's geometry. He wrote on the theory of numbers and extended their use to describe the ratios between geometrical quantities a step not taken by the Greeks.

astronomical tables (Zij) of future planetary and stellar positions was an important activity of most astronomers. Al-Battani detected elliptical orbit of the earth and made important corrections to Ptolemy's *Almagest*. Islamic scholars were the first to detect problems in the Greek astronomy dominated by the Ptolemaic system. **Al-Haytham** argued contrary to the Greeks' belief that the milky way was very far from the earth. He even estimated the height of the atmosphere to be 52,000 paces (approximately 52 km), which is close to the modern estimate.

Fig 5.5: The Arab astronomer **al-Hasib**, during the ninth century, examined the length of the shadow of a rod of unit length horizontally mounted on a wall when the sun was at a given angle to the horizontal.

In figure 1 the length of the shadow (s) can be calculated as

$$s = \sin a / \cos a = \tan a$$

where a is the angle of elevation of the sun above the horizon. The length (t) of the shadow cast by a vertical rod in figure 2 is

$$t = \cos a / \sin a = \cot a .$$

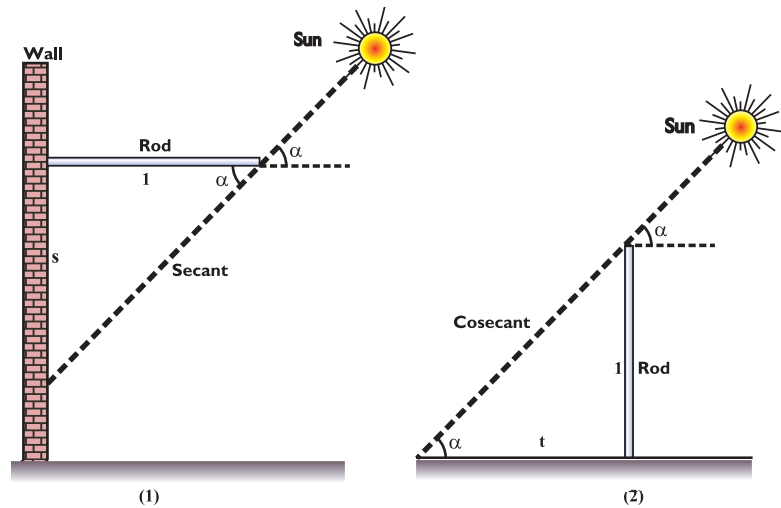

Type ($a > 0, c > 0$)	Method
1 $x^3 + c$	Intersection of two parabolas
2 $x^3 + ax = c$	Intersection of circle and parabola
3 $x^3 + c = ax$	Intersection of hyperbola and Parabola
4 $x^3 = ax + c$	Intersection of two hyperbolas
5 $x^3 + ax + c = 0$	No positive roots

Fig 5.6: **Omar Khayyam's** (1048-1122) work can be considered as the culmination of the geometric approach to the solution of general cubic equations. The table is a summary of his solutions of cubic equations.

Fig 5.7:



Fig 5.8: **The Greek astrolabe** was an instrument that Islam was to make its own. Built of brass it was flat and circular. In the centre was a disc engraved with indicator lines whose positions were worked out mathematically. This disc rotated in a holder, one side of which had a fret of thin pieces of brass ending in points that represented the stars. By rotating the inner disc it was possible to find rising and setting times for celestial bodies and determine the occurrence of astronomical events. In this respect the astrolabe was a graphical computer. The other face of the holder carried scales and a sighting arm. By its aid, the altitude and azimuth (position along the horizon measured from true north) of a celestial body could be determined. Such a way of measuring the altitude and azimuth was a specifically Arabian system. The word azimuth is itself of Arabic origin.



Fig 5.9: Separated components of an astrolabe



Fig 5.11: **Armillary sphere:** By aligning the top rings of an armillary sphere with various celestial bodies, Islamic astronomers could calculate the time of the day or year, or measure the tilt of the earth's axis or the height of the Sun. The astrological and astronomical computer, which was something like an automatic calendar, was made in Baghdad in the thirteenth century.

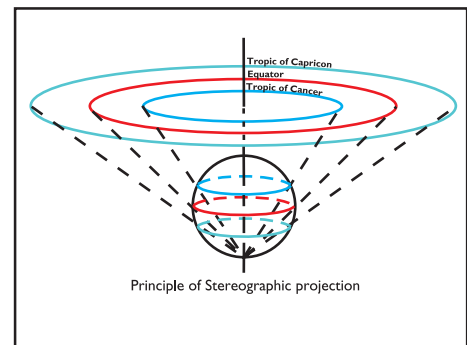

Fig 5.10: **Stereographic projection** is the principle of the plane astrolabe: a way of plotting the surface of a sphere on a plane. The instrument consists essentially of a circular star map which can be rotated about its north pole resting on a plan of the sky as seen by an observer at a given latitude.

Fig 5.12: The picture depicts astronomers using various instruments, including compass, a globe of the world, astrolabes and a mechanical clock, for measuring the position of celestial bodies at the observatory founded in 1575 at Istanbul.

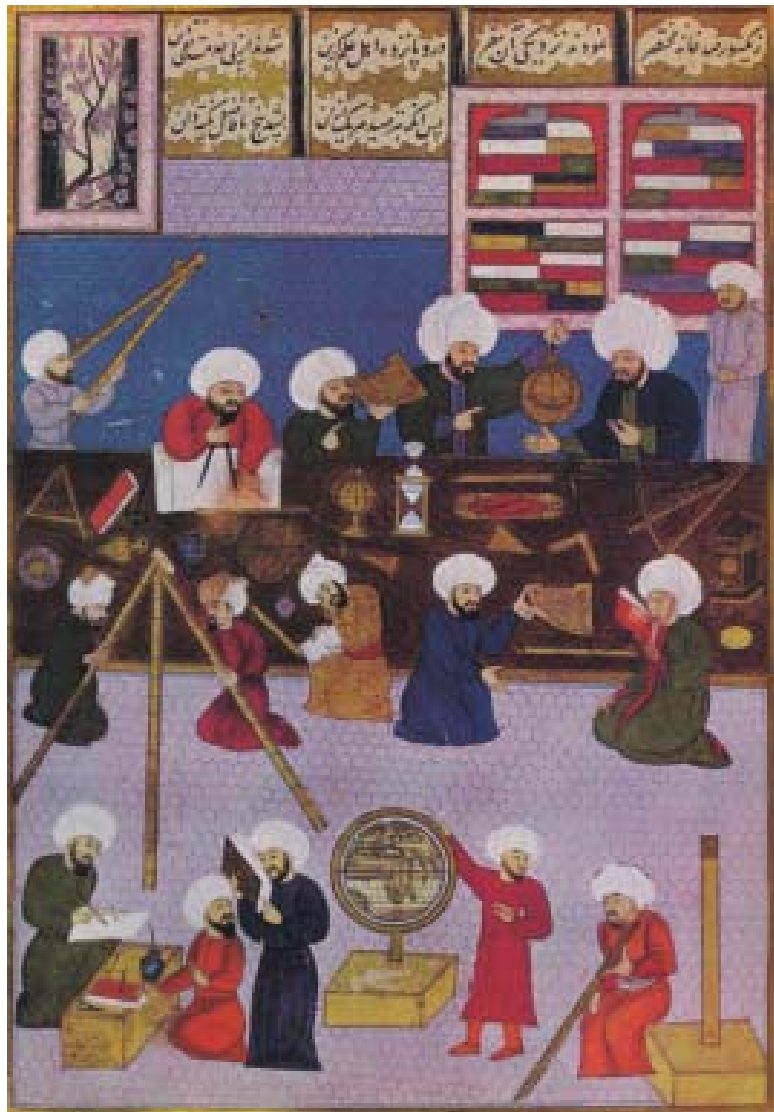

Fig 5.13: **Jabir ibn Hayyan (c. 721- c. 815)**, known by the name of the alchemist Geber of the Middle Ages, is generally regarded as the Father of Chemistry. He wrote more than one hundred monumental treatises, of which twenty-two deal with chemistry and alchemy. He introduced experimental investigation into alchemy (derived from the Arabic word *al-Kimiya*). Jabir's major achievement was the discovery of minerals and acids. Among his various breakthroughs is the preparation of nitric, hydrochloric, citric and tartaric acids.



Science and Medicine

Jabir ibn Hayyan of the eighth century, the first notable Arabic-writing alchemist, modified the Greek doctrine of the four elements. He considered sulphur and mercury as embodying combustibility and metallic nature respectively. Other metals could be formed by their combination. Thus lead could be separated into mercury and sulphur, which when recombined in a suitable proportion would make gold. Though these ideas on transmutation of elements were wrong, as we now know, Jabir did make genuine chemical discoveries. **Al Razi** (860-932), also called Rhazes, another noted Arabic alchemist and a writer on medicine, was the first to distinguish between smallpox and measles. **Avicenna**, (Ibn Sina) a great thinker and man of medicine, wrote a gigantic masterpiece: *Canon of Medicine*.

In the ninth and tenth centuries, Islamic medicine was more than just a revival of Galenic medicine. Rhazes was a successful physician who wrote many comprehensive manuals and specialized works including a book titled *Doubts Concerning Galen*. Another great physician of the time was **Al-Quff** who was a teacher, surgeon, writer and editor of medical texts and is remembered today because

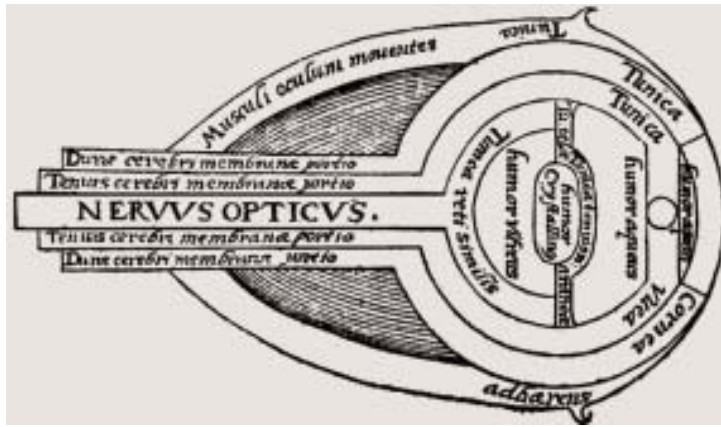

Fig 5.14: A 16th Century Western edition of Al-Haytham's Optics.



Fig 5.15: Al-Haytham (965-1040), made major contributions to optics, astronomy and mathematics, his most important contribution being a seven volume work on optics, *Kitab al-Manazir*. It introduced the idea that light rays emanate in straight lines in all directions from every point on a luminous surface.

of his description of capillaries and the use of cardiac valves. Another notable surgeon **Ibn al-Nafis** (1213-88), a prolific writer, is remembered for his discovery of the lesser circulation of the blood, i.e., the circulation between the heart and the lungs. The Arabs made significant advances in Physics also. The versatile Persian scholar **al-Biruni** made precise determination of the specific gravity of precious stones and metals. The important work of **al-Haytham** (al-Hazen) on Optics dealt with reflection, refraction, optical illusions and vision. Al-Haytham's works preached empirical evidence as a methodology of scientific investigations, which influenced European scholars and promoted the rise of humanism, and in turn the scientific revolution. It was al-Haytham who introduced the concept of 'ray of light'. Herejected the Greek idea of vision as something emanating in the eye and drew upon his physical theory of rays and mathematical construction of their paths to explain what is seen.

Fig 5.17: *Canon of Medicine* deals with general medicines, drugs (seven hundred sixty), diseases affecting all parts of the body from head to foot, specially pathology and pharmacopoeia. On the right hand page is a drawing of Avicenna lecturing to students; on the left, is a rendering of the body.



Fig 5.16: Ibn Sina (980-1037), known in the West by the name of Avicenna, was the most famous physician, philosopher, encyclopedist, mathematician and astronomer of his time. His major contribution to medical science was his famous book *al-Qanun fi al-Tibb*, known as the 'Canon' in the West. He created a system of medicine in which medical practice could be carried out and wherein physical and psychological factors, drugs and diet were combined. He made rich contributions to anatomy, gynaecology and child health.



Fig 5.18: During the tenth century, surgeons in Arabia performed caesarian operations. The picture is an artist's impression of a surgeon performing a caesarian.

The Arabs, as the above account illustrates, were not mere custodians of learning from other cultures; they played a vital role in the creative synthesis of Indian astronomy and arithmetic with that of Ptolemaic astronomy and Euclidean geometry. Arabian scholars made numerous original contributions to modern science, particularly in astronomy, optics, physiology, trigonometry and algebra.



Fig 5.19: **Al-Biruni (973-1048)** was an outstanding astronomer, mathematician, physicist, physician, geographer, geologist and historian. His contributions in physics include work on springs and accurate determination of the specific weight of eighteen elements and compounds including many metals and precious stones.



Fig 5.20: Arabic study of plants in biology and the medical sciences was largely based on their use in agriculture or medicine. An exception to this medical bias of botany originated with the *Ikhwan as Safa* or Brethren of Purity which was an esoteric sect. In their Epistles, enlightenment was taught through a study of the natural sciences. In botany this led them to examine the form and structure of plants and their growth which was a valuable contribution to knowledge.

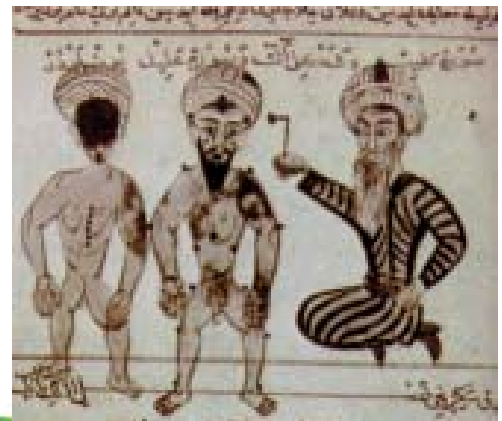
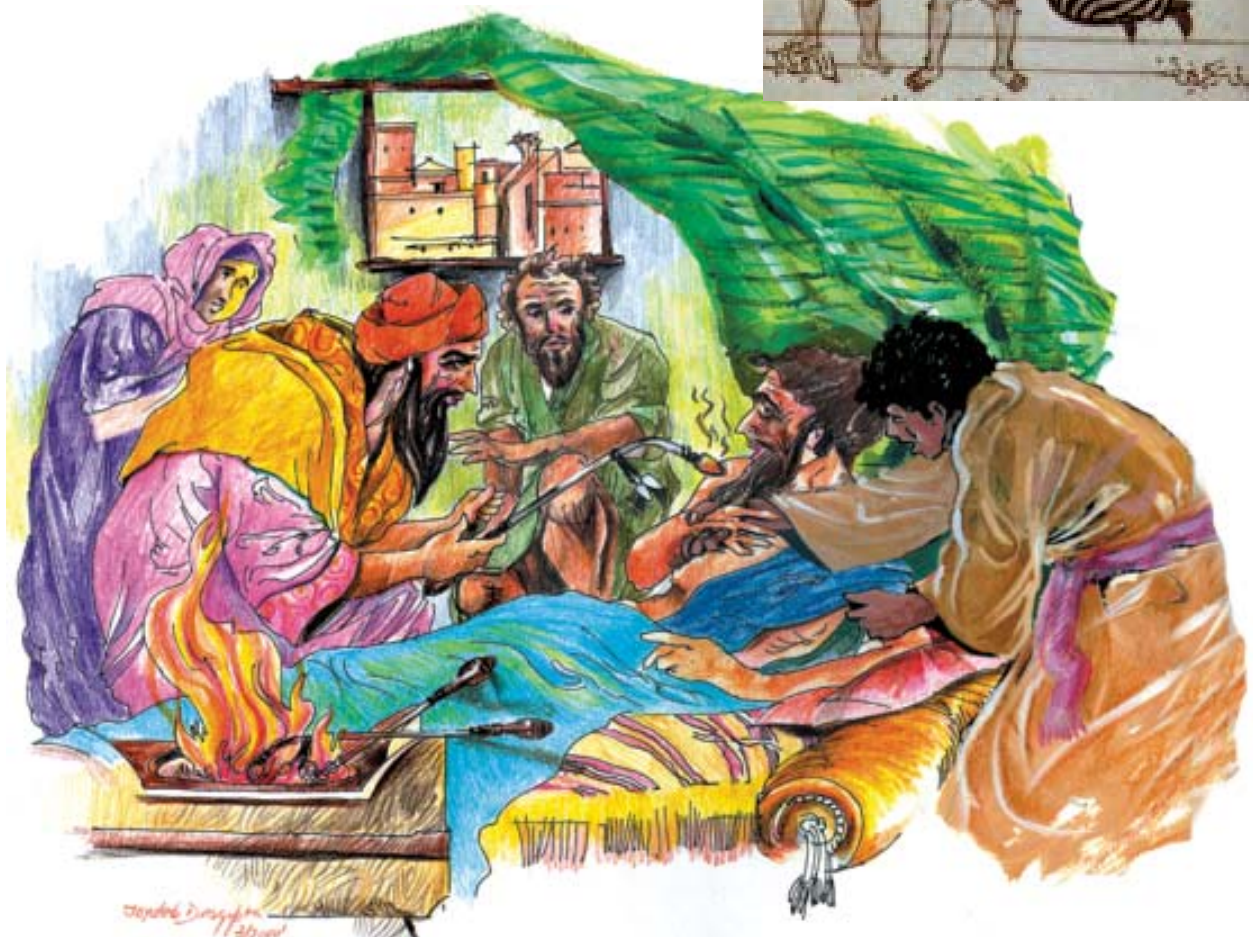

Fig 5.21: The picture is an Artist's impression of a physician treating a patient using cauterisation method.



6

Scientific Revolution

The Rise of Humanism

After Galen and Ptolemy there was a long period of 'silence' in the western world largely due to the negative attitude of the Romans towards speculative and experimental studies. Christianity, the official religion of the Roman Empire, was ambivalent towards science. The dominant group of theologians believed that secular studies would contaminate the Christian mind, while another group, though in a minority, held that understanding God's world was a way of reaching Him. From the period of **St Augustine** (354-430) to **St Thomas Aquinas** (1225-74), there was a constant tension to assimilate Greek learning into Christianity and produce an acceptable amalgam. Aquinas successfully fused Christianity with Greek and Arabic sciences. **Roger Bacon** (1214-94) further argued that even pursuing experimental science, which was banished till then, could lead to knowledge of the Creator.



Fig 6.1: A weight-driven astronomical clock constructed by Giovanni de Dondi: The upper dials trace, from the left, movements of Mars, the Sun and Venus; the lower dial is a 24-hour clock. The early mechanical clocks were regulated by a *verge* and *foliot* escapement. It was driven by a weight that hung down below the clock as shown at the bottom of this panel.

Latin translations of the Greek classics from Arabic began appearing in Islamic Spain from the twelfth century. **Adelard of Bath** translated Euclid's *Elements*, **Gerard of Cremona** translated Ptolemy's *Almagest* and **Michael Scot** translated several works of Aristotle. This corpus of secular knowledge started affecting the intellectual atmosphere of the newly formed universities of Paris and Oxford. **Robert Grosseteste** and **Roger Bacon** taught at these universities and spearheaded the new intellectual movement called *humanism*. Most notable among those who took to humanism and studied natural science at Paris and Oxford during the fourteenth century were **Thomas Bradwardine**, **Jean Buridan** and **Nicole Oresme**. Oresme (1325-82) opposed black magic and astrology. His views, which opposed Aristotle's theory of static earth, anticipated Galilean kinematics and Copernican cosmology to some extent .

Meanwhile, several technological innovations began to appear in Europe. The mariner's compass, essentially a Chinese invention, was added to the core of navigators' equipment, boosting sea trade and large scale exploration of seas, leading to the discovery of new routes and continents. By 1300, Venice had become a centre of the glass industry, and the art of lens making made the early

Fig 6.2: An old quadrangle of the Merton College, Oxford.



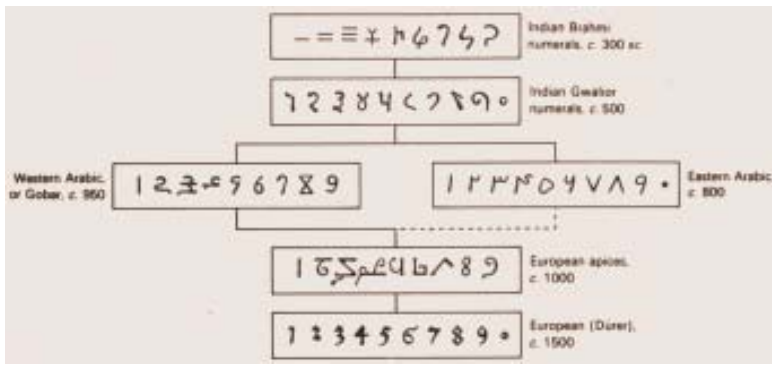

Fig 6.3: **Leonardo Fibonacci (Leonardo of Pisa) (1120-1245)** introduced the use of Indian-Arabic numerals, which included zero, to the western world. His treatise, the *Liber Abaci* (Book of computation) is based on the mathematical works of Arabic scholars. He is best remembered for the Fibonacci numbers (1, 1, 2, 3, 5, 8, 13, 21 ...)

development of optics and subsequent inventions of microscope and telescope possible. The technology of mechanical clocks was becoming increasingly refined, and this had a decisive impact on later developments in science. The alchemists, though guided by impossible aspirations, discovered important chemical processes and developed new materials and equipment. Perhaps the single greatest technological development that triggered the scientific revolution in Europe was the innovative use of movable types of cast metal for printing, by **Johannes Gutenberg** in 1447. This development led to an unprecedented activity in arts and literature, and ushered in rapid social changes.

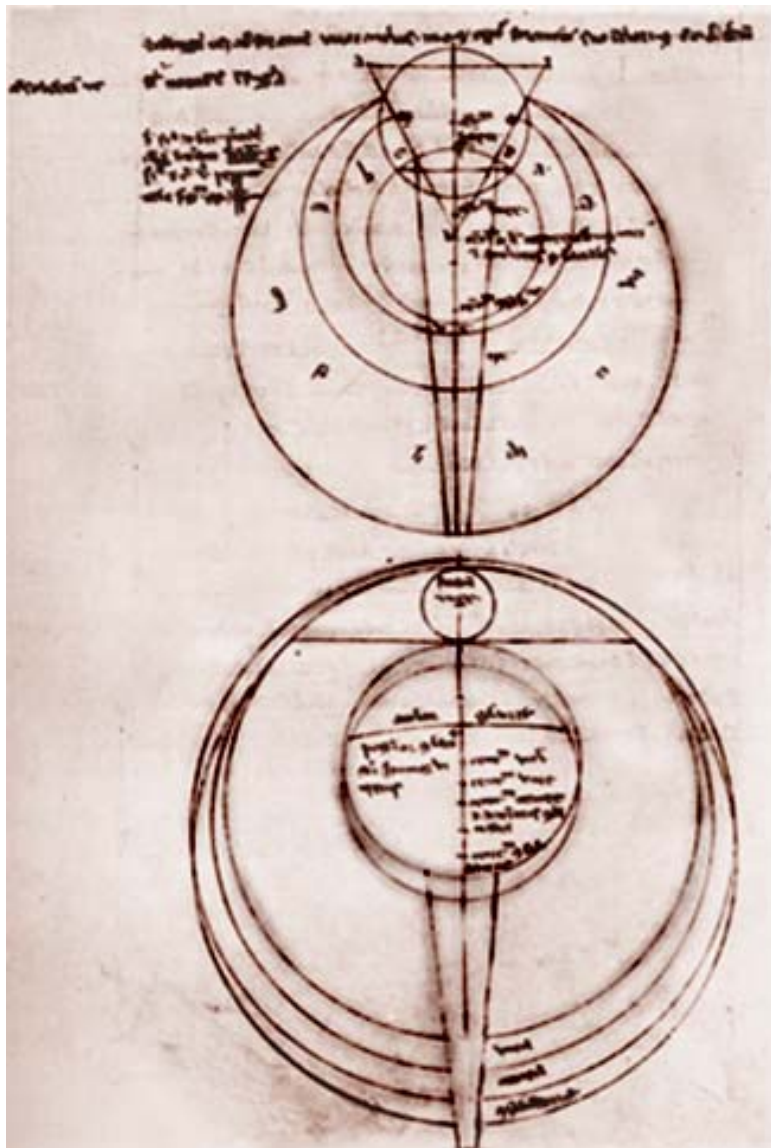

Fig 6.4: **Roger Bacon's** study of the internal structure and optics of the eye.

Fig 6.5: **Roger Bacon (1214-94)**: Influenced by Grosseteste, Bacon devoted his life to experimental science and for promoting the study of languages, mathematics, and especially optics. He indicated the possibility of combining lenses and was the first to mention the use of lenses for correcting vision.





Fig 6.6: Oresme (1325-82), a French Aristotelian scholar, economist and mathematician, helped develop analytic geometry. His mobile earth theory preceded that of Copernicus. Galileo adopted his method of measuring uniform acceleration. He worked in the court of Charles V of France, introduced coinage and brought in major changes in financial matters.



Fig 6.7: The picture shows a medieval alchemist's laboratory. The alchemists perfected the processes of distillation, crystallization, smelting and alloying of metals. They discovered the five elements Antimony, Arsenic, Bismuth, Phosphorous and Zinc as well as alcohol and many acids.



Fig 6.8: **Medieval Universities:** Several universities were established in Europe from the 12th century onwards. The earliest universities were in Bologna (1150), Paris (1200) and Oxford (1220). Though, to begin with, the universities taught mainly religious studies, languages and mathematics, natural philosophy was introduced later. Institutionalisation of education played an important role in the scientific revolution.

Fig 6.9: Mechanical clock regulated by verge and foliot escapement driven by a weight.

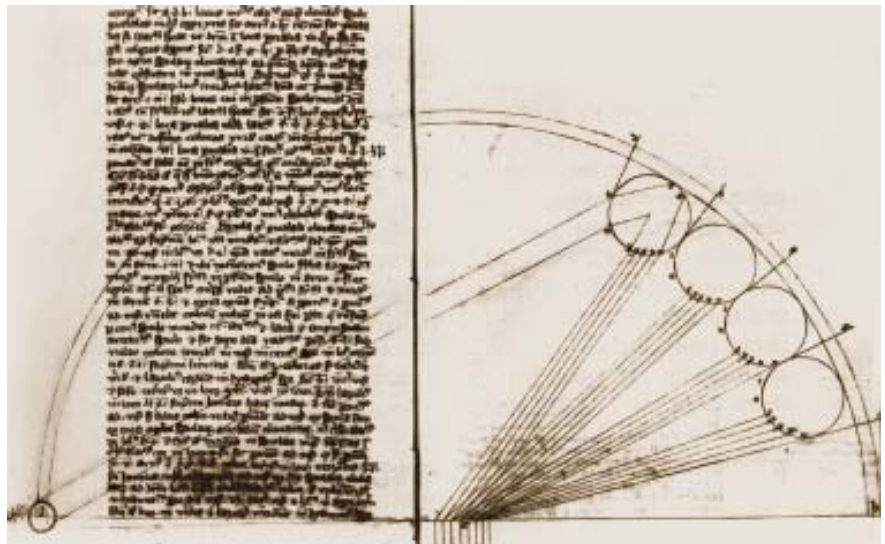
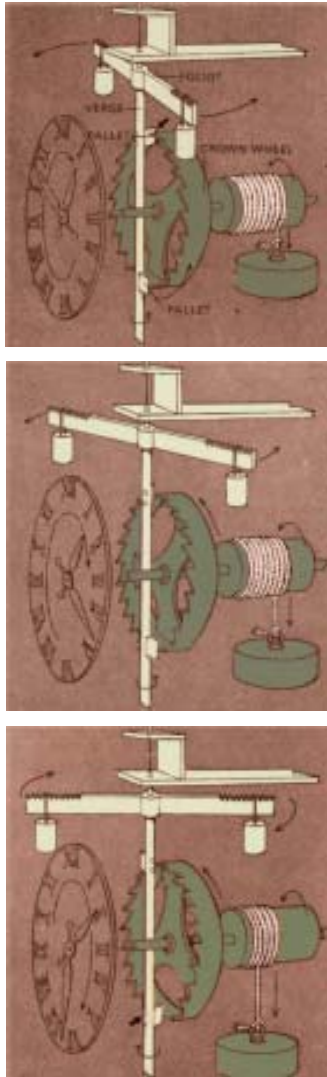

Fig 6.10: **Theory of the rainbow by Theodoric of Freiberg:** The drawing shows how two refractions and an internal reflection within individual water drops can produce a rainbow. The sun is shown at the lower left, at the upper right are raindrops, and the observer is located at the centre.

Fig 6.11: **Printer's workshop:** About 1438 the German metal worker Johannes Gutenberg invented type casting, a method of making movable type from molten metal. This invention was responsible for the rise of humanism by making the classics available to a larger number of people.



The Renaissance and the Copernican Revolution

Around the fourteenth century was the beginning of Renaissance in Europe a burst of unprecedented activity in literature and arts. The original Greek literary works were revived through translations in Latin. The laws of perspective were discovered by the Italian architect **Alberti**, which had vital influence on the work of the great Renaissance artists. Some of these artists also had an avid interest in the study of nature and human anatomy. The versatile genius **Leonardo Da Vinci** demonstrated his superb scientific skills in fields ranging from ballistics to physiology.

Renaissance was about a change in the view of not only what humans are but also about the world in which they lived. The discovery of the New World (America) by **Christopher Columbus** in 1492, was a totally unexpected event for the Europeans, and it had profound repercussions on the outlook of that time. The fallibility of ancient scholars was proved beyond doubt. The event brought into question the scholastic beliefs in every domain, and encouraged exploration.

The heliocentric theory of **Nicolas Copernicus** published in 1543, had the potential to shatter the Ptolemaic geocentric theory. However, the time was not ripe. The theory needed further support from other observations and theories by **Kepler** and **Galileo**.

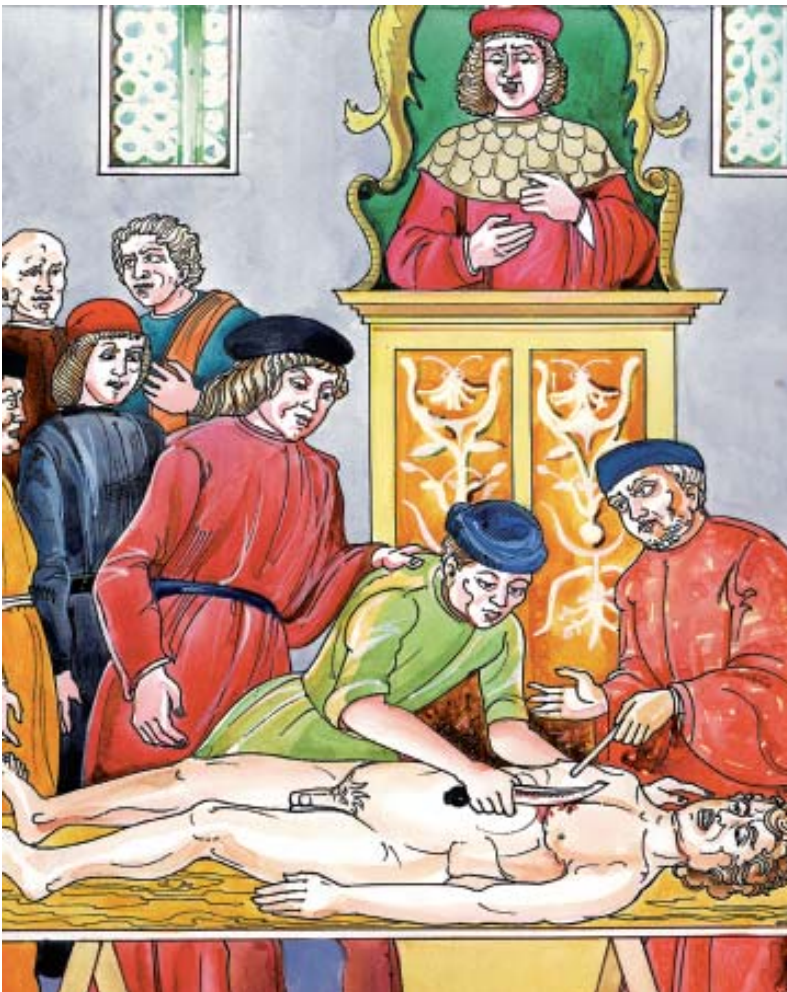

Fig 6.12: An Anatomy class at Padua in the 15th century: The professor in a red robe lectures on Galen's description, the assistant demonstrates the description, while a barber-surgeon dissects the body.

Fig 6.13: Some of the 15th century surgical instruments.





Fig 6.14: The map of the world after Christopher Columbus' discovery of America drawn in 1500 by the ship's pilot. Inset shows the mariner's compass and other map making instruments used by the navigators of that time.



Fig 6.15: Two pages from the *De Revolutionibus Orbium Coelestium*, a truly revolutionary work by Copernicus.



Fig 6.16: Nicolas Copernicus (1473-1543) and his system of the universe with the earth and other planets revolving around the sun.

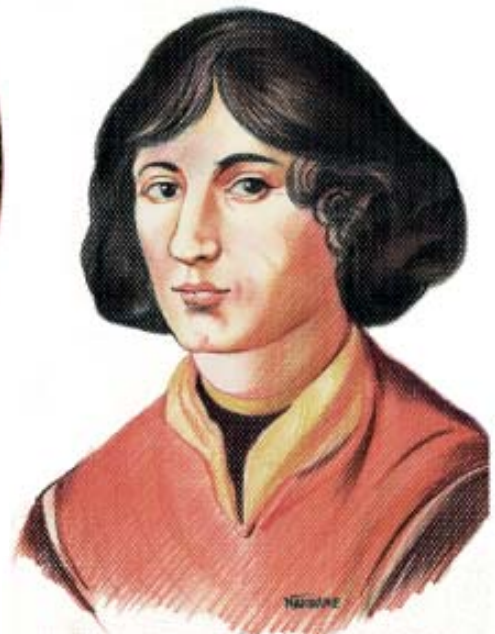

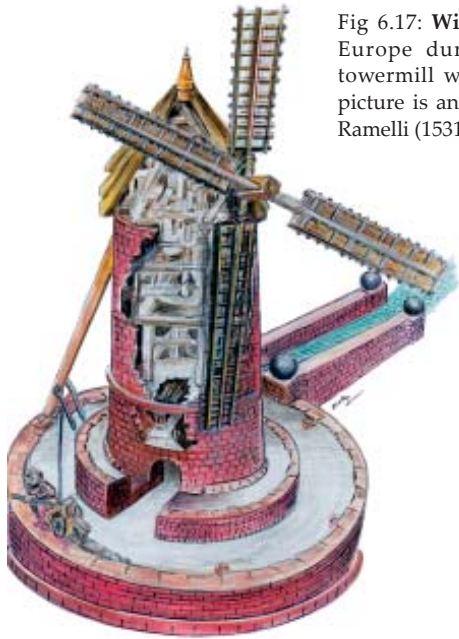

Fig 6.17: **Windmills** were widely used in Europe during the 14th century. This towermill was used to pump water. This picture is an illustration made by Agostino Ramelli (1531-1600) showing the mechanism.

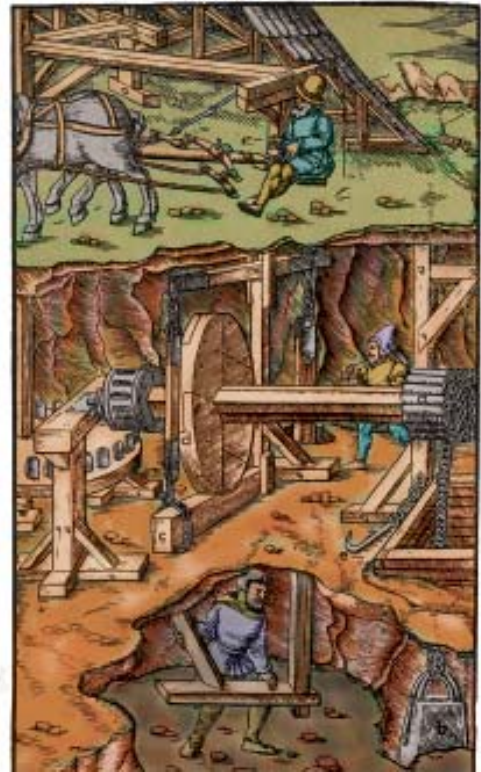

Fig 6.18: A 16th century mine from *De Metallica* of Georgius Agricola (1494-1555): Considered the founder of geology, Agricola paved the way for further systematic study of the Earth and its rocks, minerals and fossils. He made fundamental contributions to mining, metallurgy, and alaeontology.



Fig 6.19: **Leonardo da Vinci (1452-1519)** was a colossal genius. He excelled as a mathematician, painter, sculptor, architect and engineer. He constructed models of various machines, but probably none of these were ever built to full scale. He mastered the theoretical principles of perspective.

Leonardo da Vinci's sketches.

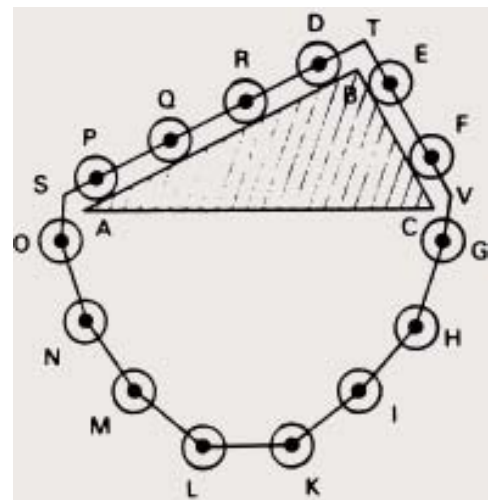

Fig 6.20: Simon Stevin's (1548-1620) demonstration of the law of the inclined plane with a string of spheres: The law states that the pull downwards towards the centre of the Earth is inversely proportional to the length of the inclined plane.

Astronomical Breakthrough

A radical departure from Greek astronomy came in the beginning of the 17th century when, based on the astronomical data of **Tycho Brahe** (1546-1601), **Johannes Kepler** discovered the mathematical laws of planetary motion. **Brahe** had meticulously recorded the observations of the positions of planets continuously unlike earlier observers who took records at predetermined astrologically or astronomically significant times.

Kepler (1571-1630) was Brahe's junior by twenty five years. A man of outstanding mathematical ability, he taught mathematics at the reputed Lutheran School at Graz. Kepler fell in love with the Copernican cosmos when he discovered that the five Platonic solids fitted exactly into the spaces between the spheres of the six planets. Kepler's calculation of the path of Mars around the Sun was a major breakthrough. He demonstrated not only that Mars' orbit is an ellipse, but also that the planet accelerates as it approaches the Sun (perihelion) and decelerates as it moves away (aphelion). These were the first observational evidences against the views of the past. He later discovered that other planets followed similar elliptical orbits, and moved with non-uniform velocities in their path.



Fig 6.21: **Giordano Bruno** (1548-1600) championed the idea of uniform infinite universe in space and time and the possibility of life in other worlds, and supported Copernicus' heliocentric theory. This was against the prevailing orthodox notion of finite hierarchical universe. For his heretical views, Bruno was burnt at the stake.



Fig 6.22: **William Gilbert** (1544-1603) laid the foundation of a systematic study of magnetism. He hypothesized that the earth was a giant magnet.

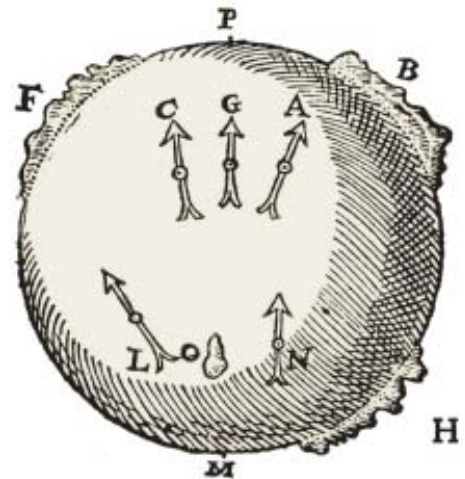

Fig 6.23: Gilbert's diagram of earth as a magnet: Shown in the illustration is a globe shaped magnet with lumps of iron to represent mountains, used by William Gilbert to demonstrate the north-seeking properties of the magnetic needle.

Fig 6.24: Instruments used for astronomical observations

Altitude sextant



Altazimuth semicircle



Solar quadrant



Altazimuth quadrant





Fig 6.25: Tycho Brahe (1546-1601) made observations of the sky with the naked eye, and recorded precise data on the motions of planets.



Fig 6.26: Tycho's Mural Quadrant, a huge brass arc of 6 feet radius was built in his observatory in 1576



Fig 6.28: Andreas Vesalius (1514-64)



Fig 6.29: Andreas Vesalius performing dissection of a human corpse



Fig 6.30: Johannes Kepler (1571-1630) discovered that the five Platonic solids fitted exactly into the spaces between the spheres of the six planets as shown in the picture.

Kepler's three laws of planetary motion

LAW I: Each planet moves in an ellipse with the sun at one focus.

LAW II: The line joining the sun to a planet sweeps out equal areas in equal times.

LAW III: The squares of the times of revolution of the planets are proportional to the cubes of their average distance from the sun. (R^3/T^2 is the same for all the planets).

Fig 6.31: Kepler's laws

Paving the path

The real credit for the overthrow of Aristotelian science goes to **Galileo Galilei** (1564-1642). Galileo's experimental research on motions of bodies upset Aristotelian mechanics in a fundamental way. Galileo introduced the basic kinematic concept of acceleration. He contradicted the Aristotelian notion that a force is required to keep a body in uniform motion, and that heavier bodies fall faster under gravity. The Galilean revolution saw science abandon teleological and metaphysical reasoning. Mechanics was reduced to a study of measurable motions of bodies under the action of definite physical forces.

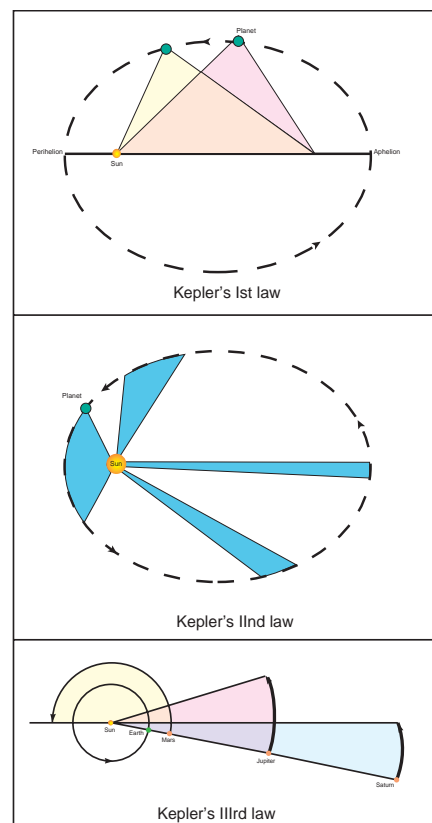



Fig 6.32: Galileo Galilei (1564-1642)



Fig 6.33: Through his telescope with improved magnification, Galileo, in 1610, observed and sketched the moon, showing its craters and mountains. He also calculated the height of the mountains on the moon.



Fig 6.34: Galileo's pendulum clock: Galileo discovered the constancy of the period of the pendulum and devised an idea for adapting a pendulum to control clockwork, although it is not known for certain whether he ever made such an instrument.

Galileo's discoveries in astronomy were equally revolutionary. In 1609, he designed the first telescope and used it to make a number of startling observations. The surface of the moon was seen to be dotted with mountains and depressions. Galileo discovered the moons of Jupiter, observed Venus and the dark spots on the Sun. His telescope also revealed a large number of stars in the Milky Way, which are not visible to the naked eye. These observations, together with Kepler's discoveries, finally spelt the doom for ancient and medieval astronomy based on idealistic and speculative conceptions of the heavens.

With Galileo came a turning point in the very method of rational inquiry of nature. Science was no longer limited to mere observations and qualitative reasoning. Science meant planned experimentation to verify or refute theories. Science meant measurement of physical quantities and a search for mathematical relations between them.

The methodology of science was expounded by two important contemporaries of Galileo: **Francis Bacon** and **Rene Descartes**. Bacon launched a strong attack on the scholastic method and expounded a method of science based on observations and inductive inference. Descartes set forth the reductionist view of science. His discovery of coordinate geometry played a crucial role in the later development of science.

Fig 6.35: Painting showing Galileo's demonstration of motion on an inclined plane



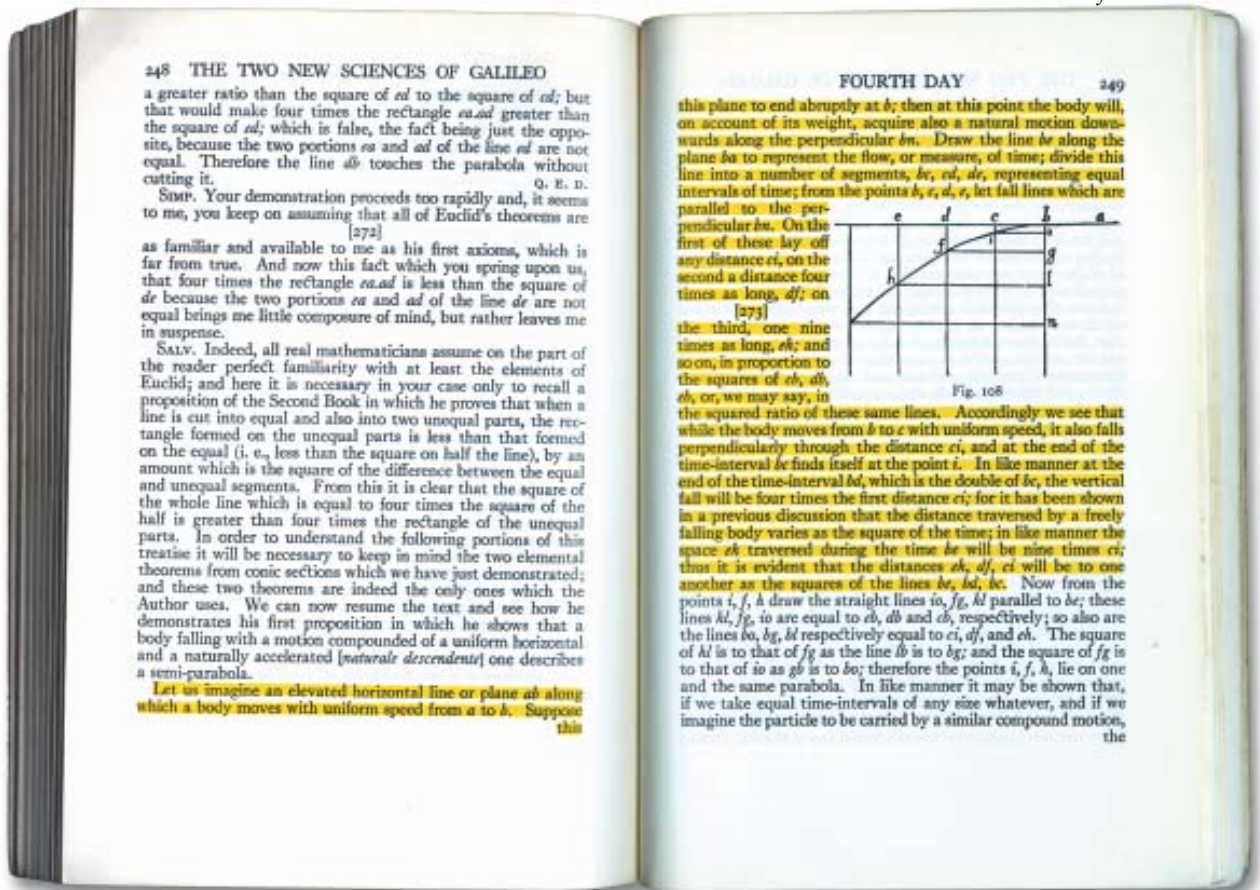

Fig 6.36: The highlighted passage from Galileo's Dialogues Concerning Two New Sciences (1632), in which he announces the relation between time and distance of a projectile.

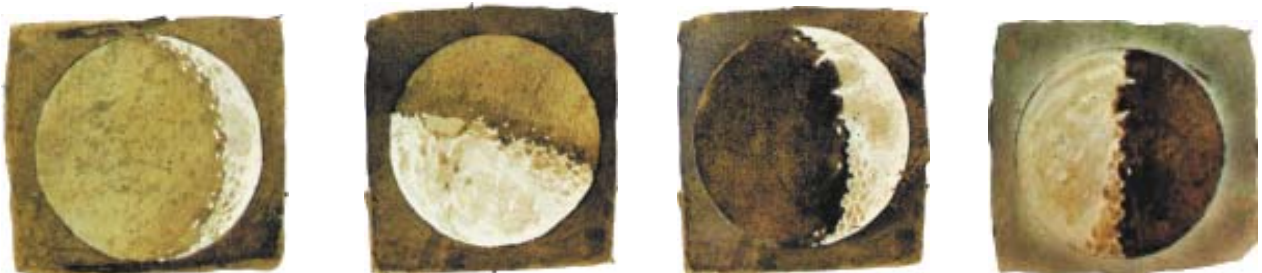

Fig 6.37: Galileo's sketches of the phases of the moon



Fig 6.38: Rene Descartes (1596-1650), a French philosopher and mathematician, created co-ordinate geometry.

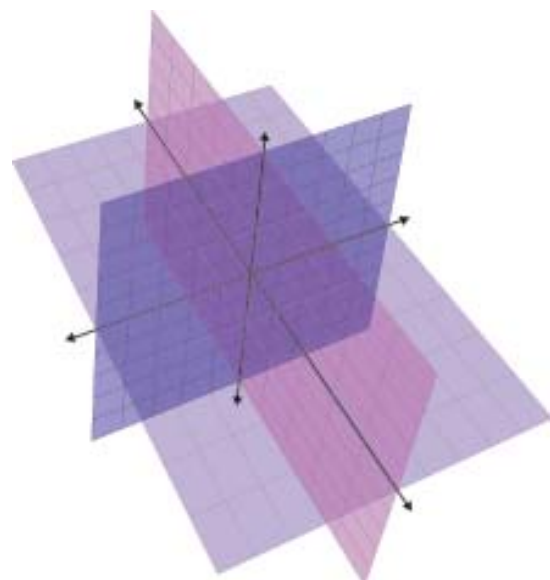

Fig 6.39: Co-ordinate geometry of Descartes

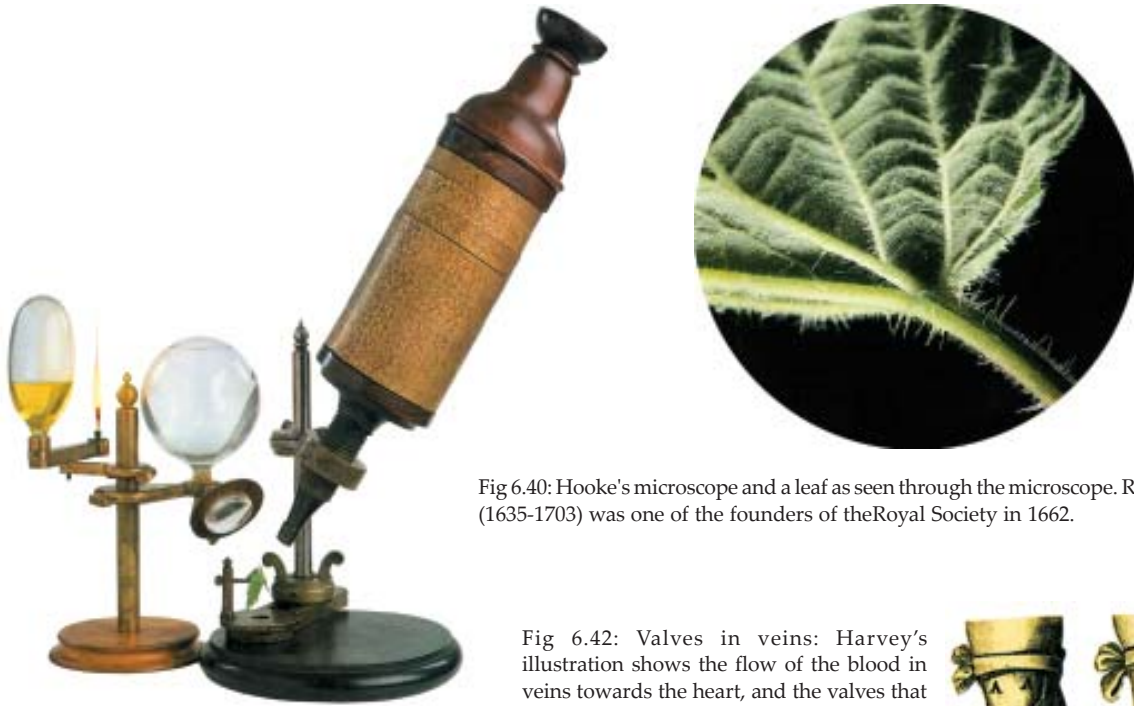

Fig 6.40: Hooke's microscope and a leaf as seen through the microscope. Robert Hooke (1635-1703) was one of the founders of the Royal Society in 1662.

Fig 6.42: Valves in veins: Harvey's illustration shows the flow of the blood in veins towards the heart, and the valves that stop the flow in the wrong direction.

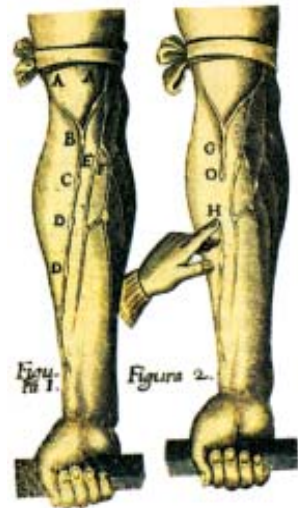

Fig 6.41: Evangelista Torricelli (1608-1647), Galileo's student, invented the mercury barometer in 1644 and discovered the notion of atmospheric pressure.



Fig 6.43: William Harvey (1578-1657), an English physician, explained the circulation of blood in the human body.



The Scientific Revolution

The Aristotelian science was a magnificent all-embracing world view that survived for two millennia. The work of **Copernicus**, **Kepler**, **Galileo** and **Descartes** exposed its inadequacy to describe the universe. But this was not enough. An alternative edifice of equal grandeur had to be erected to replace it. Remarkably, this task was accomplished almost single-handedly by one of the supreme intellects of all time, **Isaac Newton**.

Newton was born in England in 1642, the year in which Galileo died. In 1665, an outbreak of plague caused Newton to return from Cambridge to his mother's farm. There, in two years of solitude,



Fig 6.44: Artist's impression of how Newton dissociated a white beam of light into its component colours and then associated them back to the beam of light.

his dormant genius burst forth in an unprecedented flood of fundamental discoveries. He discovered the Binomial Theorem for negative and fractional exponents and perceived the first glimpses of calculus. He discovered the underlying principle of gravitation that applies uniformly to 'the fall of an apple' as well as to the orbiting planets. He also performed his classic experiment on dispersion of sunlight by a prism, which showed that white light is

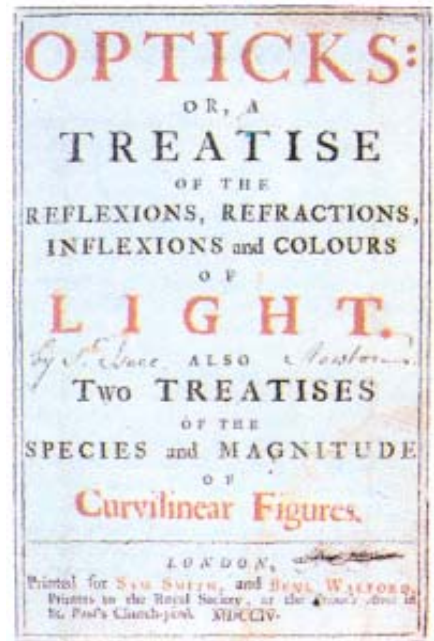

Fig 6.45: The front page of Newton's book *Opticks*.

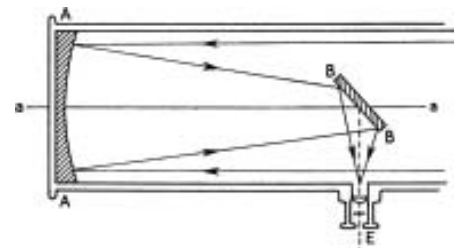

Fig 6.46: Newton's design of a reflecting telescope, which he built in 1668. The incoming light is gathered in the mirror, and then reflected by one or more small mirrors into the observer's eye.



Fig 6.48: Newton's telescope



Fig 6.47: Sir Isaac Newton (1642-1727)

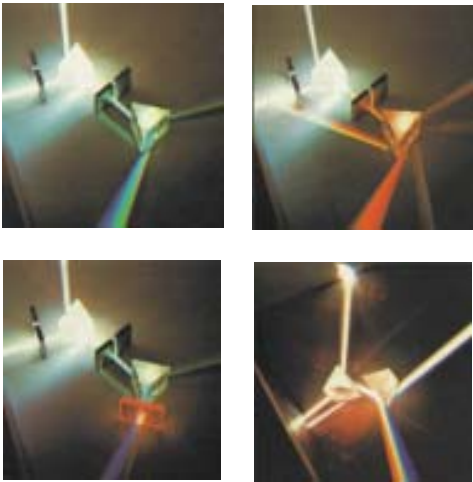

Fig 6.49: Newton's experiment demonstrating dispersion and composition of light.

Newton's experiment demonstrating dispersion and composition of light

'Then I placed another Prisme so that the light might pass through that also. This done, I took the first Prisme in my hand and turned it to observe to what places on the wall the second Prisme would refract them.'

'When any one sort of Rays hath been well parted from those of the other kinds, it hath afterwards obstinately retained its colour.'

'I have transmitted [light] through coloured Mediums, and diversly terminated it; and yet could never produce any new colour out of it.'

'I have often with Admiration beheld, that all the Colours of the Prisme being made to converge, and thereby to be again mixed, reproduced light, intirely and perfectly white.'



Fig 6.50: Newton's diagram of the flight of a cannon ball: He explained mathematically that the cannon ball, if fired from the top of a mountain with sufficient speed, can be made to orbit the earth.

a mixture of different colours. Returning to Cambridge in 1667, Newton pursued his interests in optics and built the first reflecting telescope.

Newton published his masterpiece, *Principia Mathematica* in 1687, in which he formulated Galileo's findings in terms of three laws of motion, enunciated the universal inversesquare law of gravitation and used it to explain all of Kepler's laws of planetary motion. The book was packed with a host of other awe-inspiring achievements: basic principles of fluid dynamics, mathematics of wave motion, calculation of the masses of the earth, the sun and other planets, explanation of the precession of equinoxes, the theory of tides, and so on. In 1704, Newton published another significant book, *Opticks*, that dealt with his work on light and colour. Newton's corpuscular theory of light held sway over **Christiaan Huygen's** (1629-95) wave theory of light for a long time, more due to the preeminence of Newton than due to its merit.

The scientific revolution, begun by Copernicus and completed by Newton, gave a world view that was fragmentary in one sense and unitary in another. It rejected the ancient unified system in which moral and physical philosophy were integrated. It decoupled rational understanding of physical universe from moral and metaphysical considerations. Yet the new era of science brought its own supreme unification: celestial motion and terrestrial motion were found to be governed by the same laws of nature. *The Age of Reason* had been inaugurated.

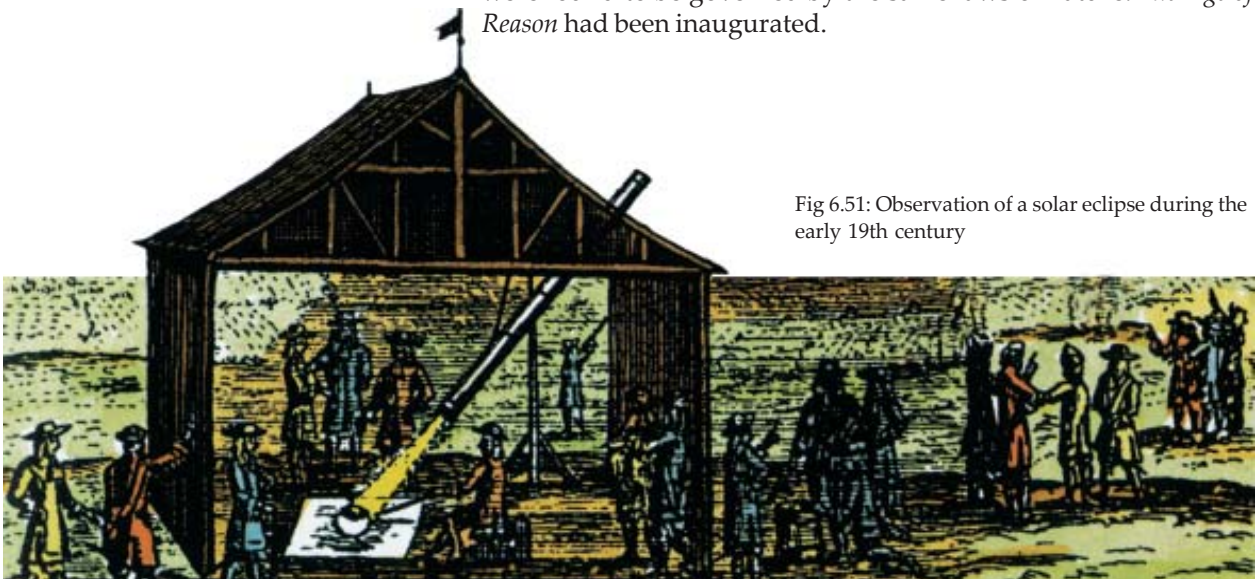

Fig 6.51: Observation of a solar eclipse during the early 19th century



Fig 6.52: Gottfried Wilhelm Leibniz (1646-1716), a German philosopher, psychologist, theologian, historian, jurist and a distinguished mathematician who independently developed calculus.



Fig 6.53: **Edmund Halley** (1656-1742), using Newton's newly formulated laws of motion, predicted that the comet seen in 1531, 1607, and 1682 would return in 1758. The comet was later named in his honour.



Fig 6.54: Halley's Comet, as seen from the Greenwich Observatory in 1836.

The Birth of Modern Mathematics

The European Renaissance did not contribute much to the growth of mathematics. The concept of perspective in Renaissance art, however, did give rise to *Projective Geometry*. With the Galilean revolution in science, mathematics began to be perceived as the soundest form of knowledge, and the stage was set for its dramatic progress.

Pierre de Fermat (1601-65), a noted mathematician of the 17th century, made important discoveries in number theory. Of decisive significance to science was the founding of coordinate geometry by **Fermat** and **Descartes**. This marked the beginning of the dominance of algebraic over geometric reasoning in mathematics. The practical problems of treating motion with variable velocity, finding out the length of a curve, its tangent at any point and its maxima and minima led **Newton**, and **Leibniz** independently, to the greatest creation in mathematics: calculus.



Fig 6.55: **John Napier** (1560-1617), a Scottish mathematician developed logarithms. Kepler used logarithms for performing the laborious calculations at the suggestion of Henry Briggs of Oxford. He invented a series of rods, known as "Napier's Bones", engraved with numbers that could be set side by side for doing complex multiplications and divisions .



Fig 6.56: Napier's Bones

The 18th century saw a rapid growth in different areas of calculus: ordinary and partial differential equations and differential geometry. The Brachistochrone problem was the source of a new discipline, calculus of variations, that was to play a major role in classical and modern science. The key mathematician of this century was **Leonhard Euler** (1707-1783). His numerous contributions include the famous formula:

$$e^{i\theta} = \cos\theta + i \sin\theta$$

the rule $V - E + F = 2$ connecting the numbers of vertices, edges and faces of a simple polyhedron, as well as his proofs of some of Fermat's theorems and his discoveries in infinite series, infinite products and continued fractions. The Euler constant,

$$\gamma = \lim_{n \rightarrow \infty} \left(1 + \frac{1}{2} + \frac{1}{3} + \dots + \frac{1}{n} - \ln n \right) = 0.5772$$

that he introduced in connection with certain integrals is the most important special number in mathematics after p and e .

Carl Gauss is generally regarded as one of the greatest mathematicians of all time. At the age of 24, he published his famous treatise '*Disquisitiones Arithmeticae*' that marked the birth of modern number theory. It contained the first proof of the '*Fundamental Theorem of Arithmetic*'. In his doctoral dissertation (1799) Gauss proved the '*Fundamental Theorem of Algebra*' and inaugurated the age of existence proofs. Gauss was equally superb in applied work too, and contributed to astronomy and magnetism. A mundane governmental assignment to supervise a geodetic survey of the country led Gauss in a few years to one of the most profound mathematical ideas, namely that all the geometrical properties of a surface, including its curvature, can be derived from the definition of distance (metric) on it without any reference to the surrounding space in which the surface is embedded. Thus was founded a new discipline: the intrinsic differential geometry of general curved surfaces.



Fig 6.57: **Pierre Fermat** (1601-65) wrote his last theorem in the margin of one of his books, adding "I have found a truly wonderful proof which this margin is too narrow to contain." Mathematicians tried in vain to prove this theorem for three centuries. At last its proof was found in 1994.

1. **Fermat's Two Square Theorem:** Every prime number of the form $4n + 1$ can be written as the sum of two squares in one and only one way.
2. **Fermat's Theorem:** If p is any prime number and n is any positive integer, then p divides $n^p - n$.
3. **Fermat's Last Theorem:** If $n > 2$, then $x^n + y^n = z^n$ cannot be satisfied by any positive integer x, y, z .

Fig 6.58: Co-ordinate geometry of Descartes

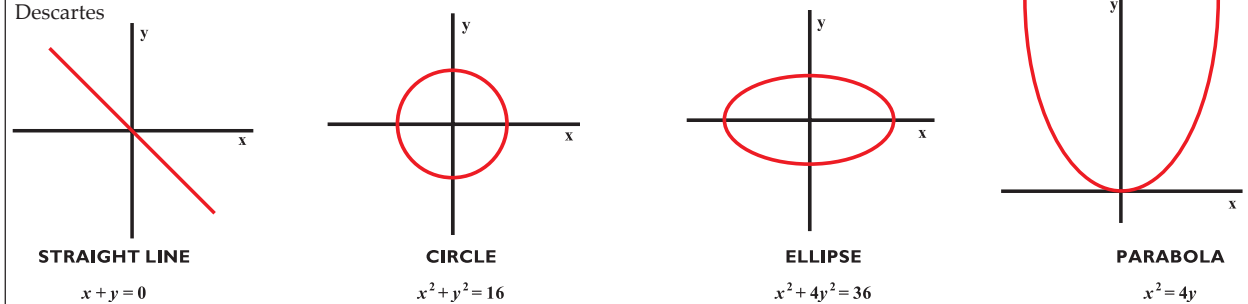

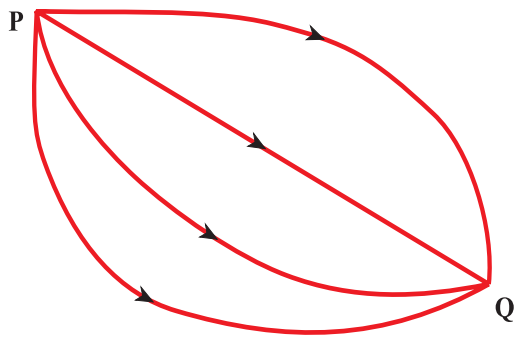

Fig 6.59: **The Brachistochrone Problem:** (brachistos = shortest, chronos = time) Imagine a bead descending along a wire bent into the shape of an arbitrary curve between two points P and Q. Which shape of the curve will give the shortest time of descent? This famous Brachistochrone problem was proposed in 1696 by Johann Bernoulli (1667-1748) as a challenge to the mathematicians. It was solved by Newton, Leibniz, as well as by the Bernoulli brothers (Johann and Jacob). **The answer:** The required trajectory is a cycloid - the curve traced by a point on a rolling circular ring.



Notion of a Functional, $y = f(x)$:

$$J = \int_a^b F(x, y, dy/dx) dx$$

y is a function of x ; to each value of x , there corresponds a value of y . J is a functional; to each function in the integral, there corresponds a number. Functionals appear in problems of calculus of variations. Jacob Bernoulli (1654-1705) and Johann Bernoulli invented the calculus of variations where the value of an integral is thought of as a function of the functions being integrated. Functional analysis is a major theme of contemporary mathematics and physics.

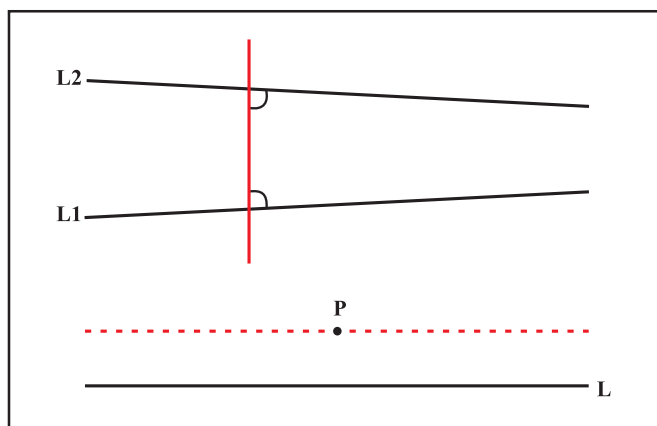
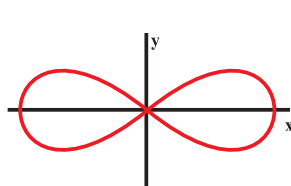
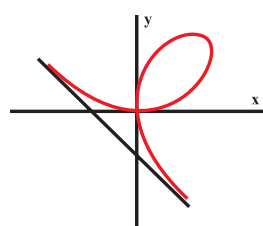

Fig 6.60: **Euclid's Fifth (Euclid's parallel postulate):** If two straight lines lying in the plane are met by another line, and if the sum of the internal angles on one side is less than two right angles, then the straight lines will meet if extended sufficiently on the side on which the sum of the angles is less than two right angles. The parallel postulate (combined with other postulates of Euclidean Geometry) is equivalent to the Playfair Axiom: Given, in a plane, a line L and a point P not on L ; then through P there exists one and only one line parallel to L . Attempts to derive this axiom from the other axioms failed. This failure led in due course to the creation of Non-Euclidean geometry.

Fig 6.61:



THE LEMNISCATE OF BERNOULLI
 $(x^2 + y^2)^2 = a^2(x^2 - y^2)$



THE FOLIUM OF DESCARTES
 $x^3 + y^3 = 3axy$

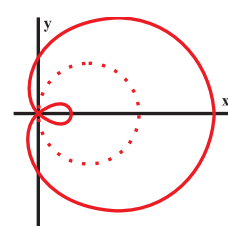

THE LIMACON OF PASCAL
 $(x^2 + y^2 - ax)^2 = b^2(x^2 + y^2)$

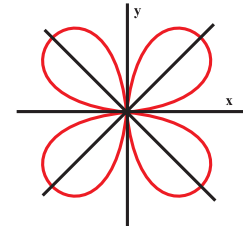

A ROSE OF GRANDI
 $(x^2 + y^2)^3 = 4a^2xy^2$

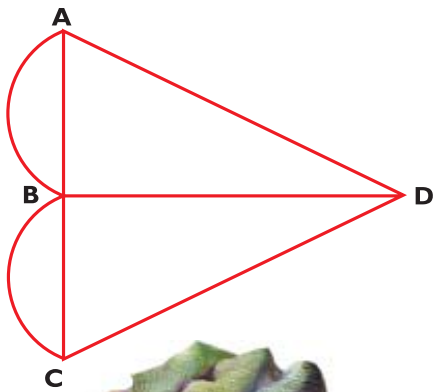

Fig 6.62: Leonhard Euler (1707-83)

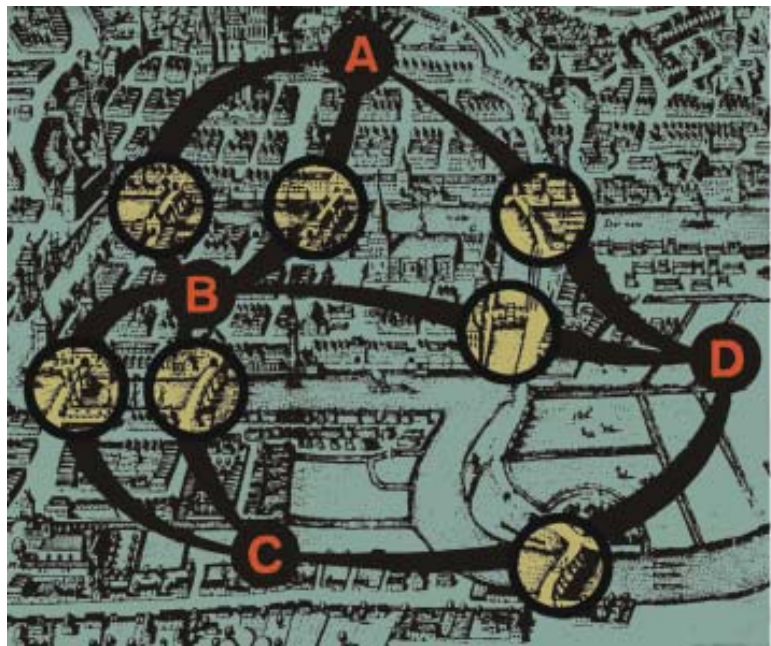

Fig 6.63: **The Königsberg Bridge Problem:** In a river flowing through Königsberg, there are two islands and seven bridges. Is it possible to cross all seven bridges in one continuous path without recrossing any one? Euler proved that it was not possible. He pointed out that some retracing is inevitable whenever there are three or more points at which an odd number of pathways converge.

Fig 6.64: **The creation of calculus:** Newton interpreted y in the figure as the rate of change of area z at any x , and realized that by reversing the process of finding a rate of change, area can be obtained. He thus glimpsed what is now called the fundamental theorem of calculus. Newton called a variable a 'fluent' and its rate of change the 'fluxion'. Leibniz arrived at much the same idea independently. The notation for integral is due to Leibniz.

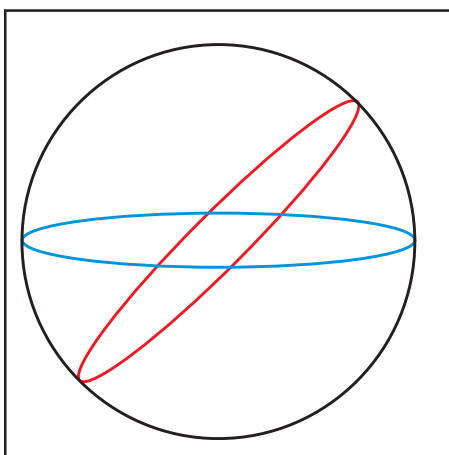
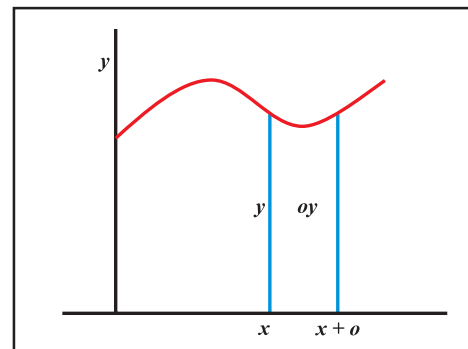

Fig 6.65: **The straight line on a sphere:** A straight line between two points in ordinary space is a curve of the shortest length. A geodesic is the generalization of the notion of a straight line that applies to any space. On the two-dimensional space of the surface of a sphere, a geodesic between two points is the arc of the great circle passing through the points.

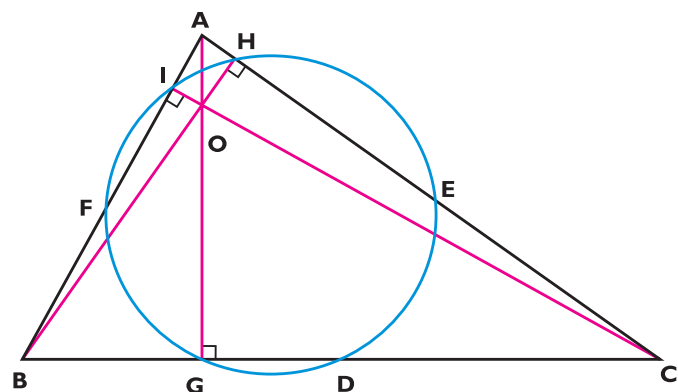

Fig 6.66: **Nine-point circle:** With every triangle are associated nine particular points: the mid-points of the sides, the feet of the three altitudes, and the mid-points of the segments which join the vertices to the point of intersection of the altitudes. All the nine points lie on one circle, called the nine-point circle. There are many references in the history of mathematics to the nine-point circle. Feuerbach and Euler are among those who referred to it.



Fig 6.68: Eight year old Gauss pictured sampling a cherry while he was a student at St. Katherine School in Brunswick, Germany. Being a child prodigy he was specially tutored in advanced mathematics in the school.



Fig 6.67: Carl Gauss (1777-1855)

Fundamental Theorem of Arithmetic:

Every integer ($n > 1$) can be expressed uniquely as a product of primes.

Fundamental Theorem of Algebra:

Every polynomial equation with real or complex co-efficients has a real or complex root.

Fundamental Theorem of Calculus:

If $F(x) = \int_{x_0}^x f(x) dx$, $F'(x) = f(x)$

7

The Chemical Revolution

Preludes to the Chemical Revolution

During the Renaissance chemical research continued to be influenced by the alchemists, who wanted to keep their secrets away from the gaze of common folk. Despite the esoteric, enigmatic and elusive nature of their knowledge, the positive contribution of the alchemists was the gradual development of effective and elaborate chemical apparatus. Practical chemistry also grew during this period as a result of developments in mining, production of gunpowder and metallurgy. **Biringuccio** (1480-1540) published a famous and important book called *Pirotechnia* describing the methods of distillation, manufacture of gunpowder, metallurgy, and casting of fonts for the printing industry.

Robert Boyle (1627-91), influenced by Newton's atomist world view wrote a path breaking book, *The Skeptical Chymist*, which spurred the development of atomistic experimental chemistry in the 18th century. The most notable chemist in the beginning of the 18th century was **Georg Stahl** (1660-1734). In his book *Fundamentals of Chemistry*, he initiated analysing compounds into their elements and studying their combinations, which provided a clear direction to experimental chemistry. He also introduced a great unifying concept phlogiston (burning principle) for explaining combustion,

Fig 7.2: The Alchemists' Laboratory with flasks, retorts and a balance was the precursor to the newly emerging experimental chemistry.

Fig 7.1: **Paracelsus** (1493-1541), though in many ways an alchemist, opposed the dogmatic scholarship of the middle ages. He burnt the works of the Greek Galen and the Arab Avicenna, and bravely proposed a departure from the 'four elements' theory of Greek philosophy.



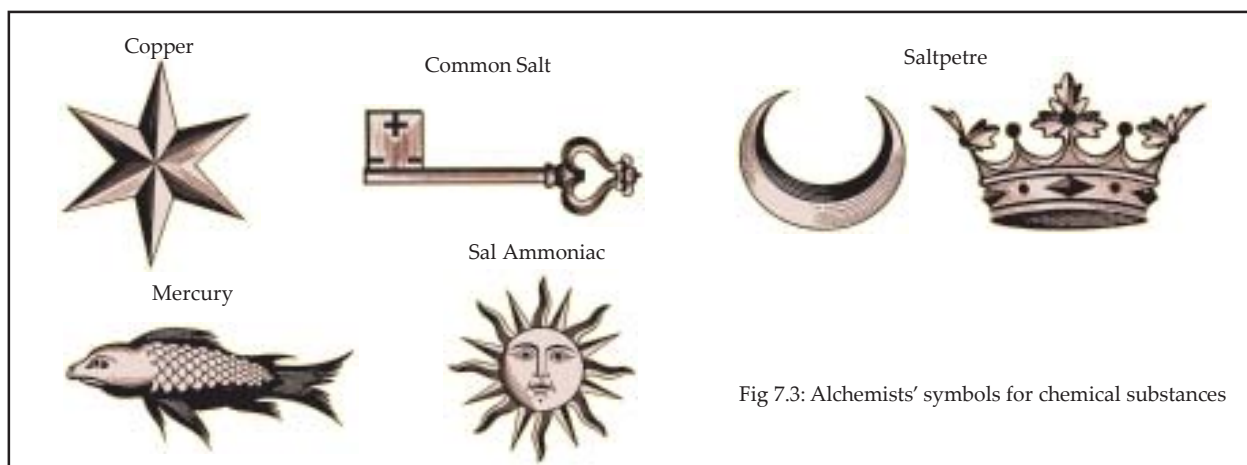

Fig 7.3: Alchemists' symbols for chemical substances

respiration and calcination, thus hinting at a deeper connection between different kinds of chemical reactions.

Joseph Black (1728-99) in the middle of the century, proposed that air was not one single substance by discovering a component of air called 'fixed air' (carbon dioxide) produced during respiration, combustion and fermentation. The ancient view that air is one of the four basic elements was challenged. Soon **Henry Cavendish** (1731-1810) reported to the Royal Society in 1766, the discovery of 'inflammable air' (hydrogen), adding another component to air.

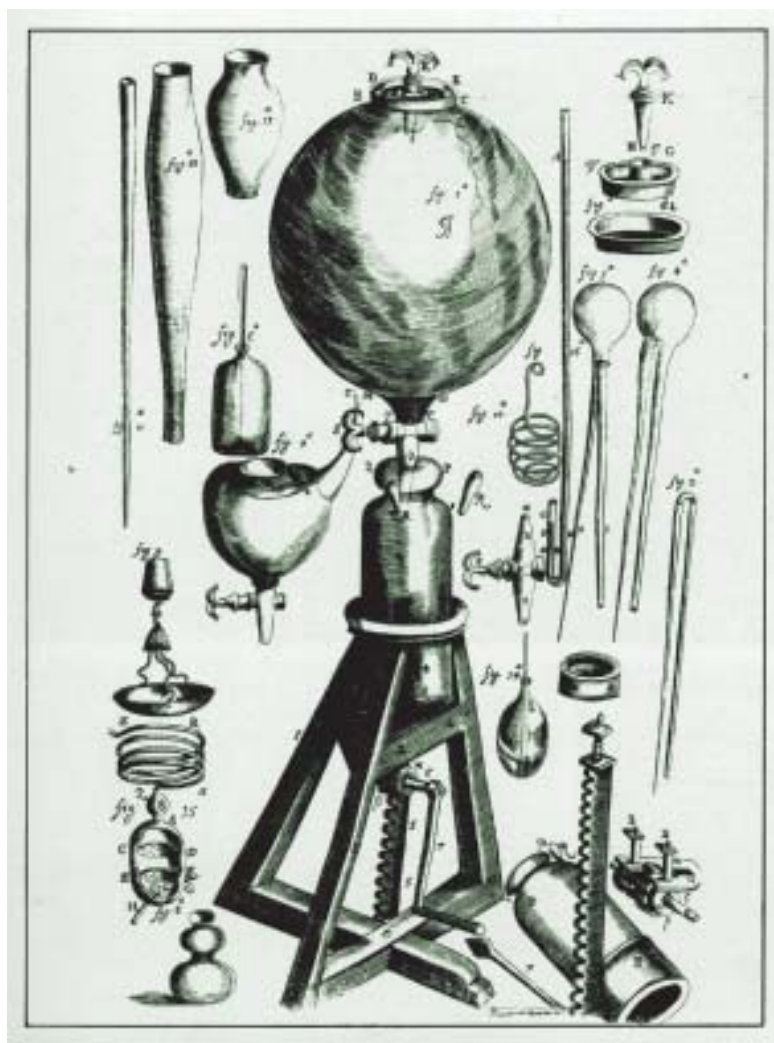

Fig 7.4: Air-pump built by Robert Boyle and Robert Hooke for creating vacuum.

Fig 7.5: **Robert Boyle** (1627-1691), a member of the British aristocracy, was responsible for making chemistry a respected discipline. Boyle also introduced and devised experiments for the study of physical and chemical properties of gases. These have led to the foundation of physical chemistry.





Robert Boyle on Elements:

"And, to prevent mistakes, I must advertise you, that I now mean by elements, as those chymists that speak plainest do by their principles, certain primitive, and simple, or perfecting unmingled bodies; which not being made of any other bodies, or of one another, are the ingredients of which all those called perfectly mixt bodies are immediately resolved: now whether there be any one such body to be constantly met with in all, and each of those that are said to be elemented bodies is the thing now in question."

From *The Sceptical Chymist* (1661)

Fig 7.6: **Joseph Black** (1728-1799), a Scottish scholar, produced a gas called 'fixed air' (carbon dioxide) from limestone. This was the first component of air to be isolated and studied in detail.



Fig 7.7: **John Mayow** (1640-1679)

Fig 7.8: John Mayow demonstrated that both respiration and combustion consumed some substance from the air. The picture shows his apparatus for collecting gases over water.

The Chemical Revolution

Joseph Priestley (1733-1804), an able experimenter, identified 'dephlogisticated air' in 1774, which was later to be called 'oxygen' by **Antoine Laurent Lavoisier** (1743-1794). Lavoisier experimentally proved that water, another of the four 'basic elements', is a compound of hydrogen and oxygen. He further proved that metals, such as mercury, iron, etc., are elements, not compounds. He introduced the principle of conservation of the weight of reactants and products, heralding the modern quantitative chemistry. He introduced the method of analysis and synthesis as the criterion for determining the elemental nature of chemical substances.



Fig 7.9: **Joseph Priestley** (1733-1804)

Chemistry in the 19th century grew on the certain and firm foundations laid by Lavoisier. The century began with the announcement of an atomic theory by **John Dalton** (1766-1844). **Gay-Lussac's** (1778-1850) law of combining volumes and **Avogadro's** (1776-1856) hypothesis that equal volumes of gases contain equal numbers of molecules gave further support to Dalton's

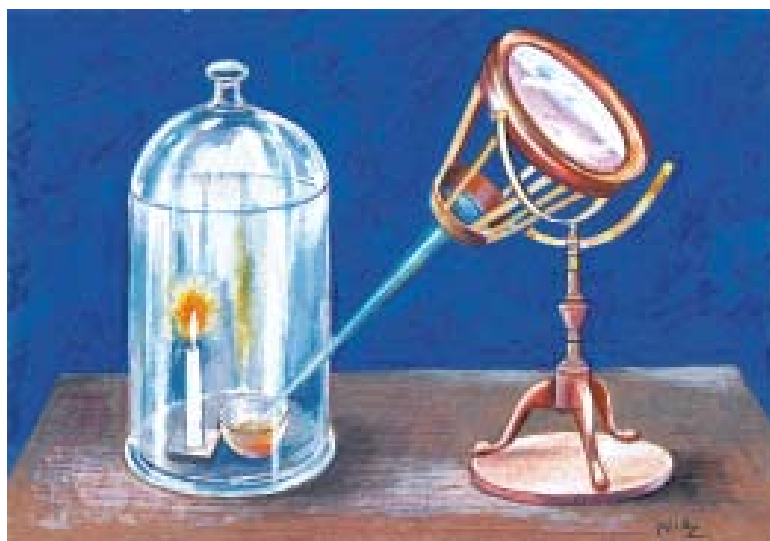

Fig 7.10: **Priestley's Experiment:** As a concentrated beam of sunlight heats a basin of mercuric oxide (calx), beads of mercury form and the candle in the bell jar burns with 'a remarkably vigorous flame'. This experiment performed by Priestley in 1774 was crucial to his eventual discovery of 'dephlogisticated air'.



Fig 7.11: **Sir Humphry Davy (1778-1829)** devoted his time to the study of electrochemistry and discovered new elements such as sodium, potassium, strontium, calcium, barium and magnesium. Together with **Michael Faraday**, he analysed diamond by combustion and concluded that it was made of pure carbon.

theory. All these developments enabled **Cannizzaro** (1826-1895) to measure the atomic weights of chemical substances. The Swedish chemist **Berzelius** (1779-1848) refined the methods of ascertaining atomic weights, and invented a convenient symbolism for all the elements, which is still in vogue. Using the technique of electrolysis invented by **Alessandro Volta** (1745-1827), **Humphry Davy** (1778-1829) decomposed many chemical solutions, such as caustic potash and soda, which eventually led him to correct Lavoisier's oxygen-based theory of acids.

Fig 7.12: **Antoine Lorent Lavoisier (1743-1794)**, architect of the chemical revolution.

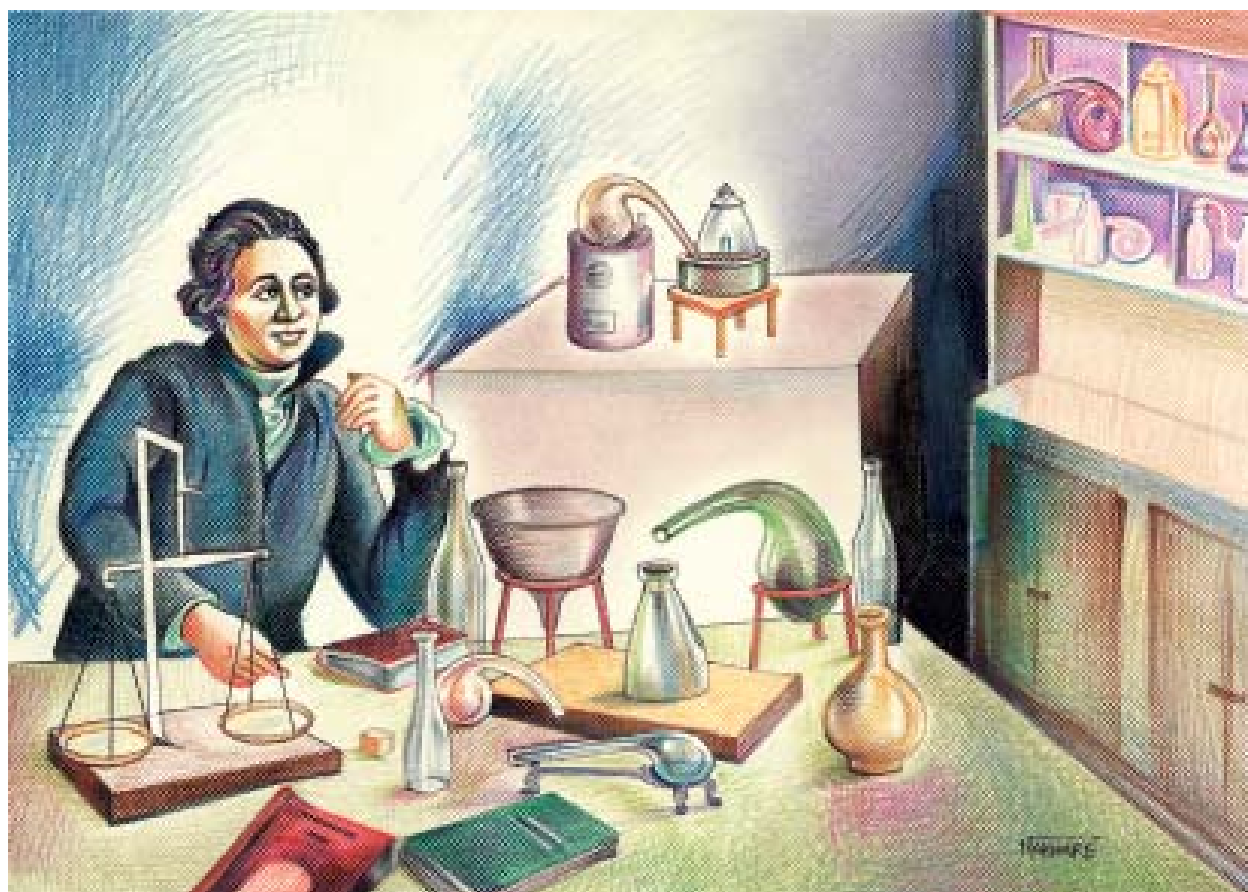



Fig 7.13: Dalton's drawings of different kinds of atoms of "elastic fluids" (gases)



Fig 7.15: Jons Jacob Berzelius (1779-1848) established the system of chemical nomenclature that we use today and also built up a table of atomic weights.



Fig 7.14: John Dalton (1766-1844), son of a poor weaver, left school at the age of 11 and worked as a village school teacher. He suggested that the gases in the atmosphere were mixed and not chemically combined. According to his atomic theory, all elements are composed of atoms of their own kind, and in a chemical reaction, atoms separate and unite.

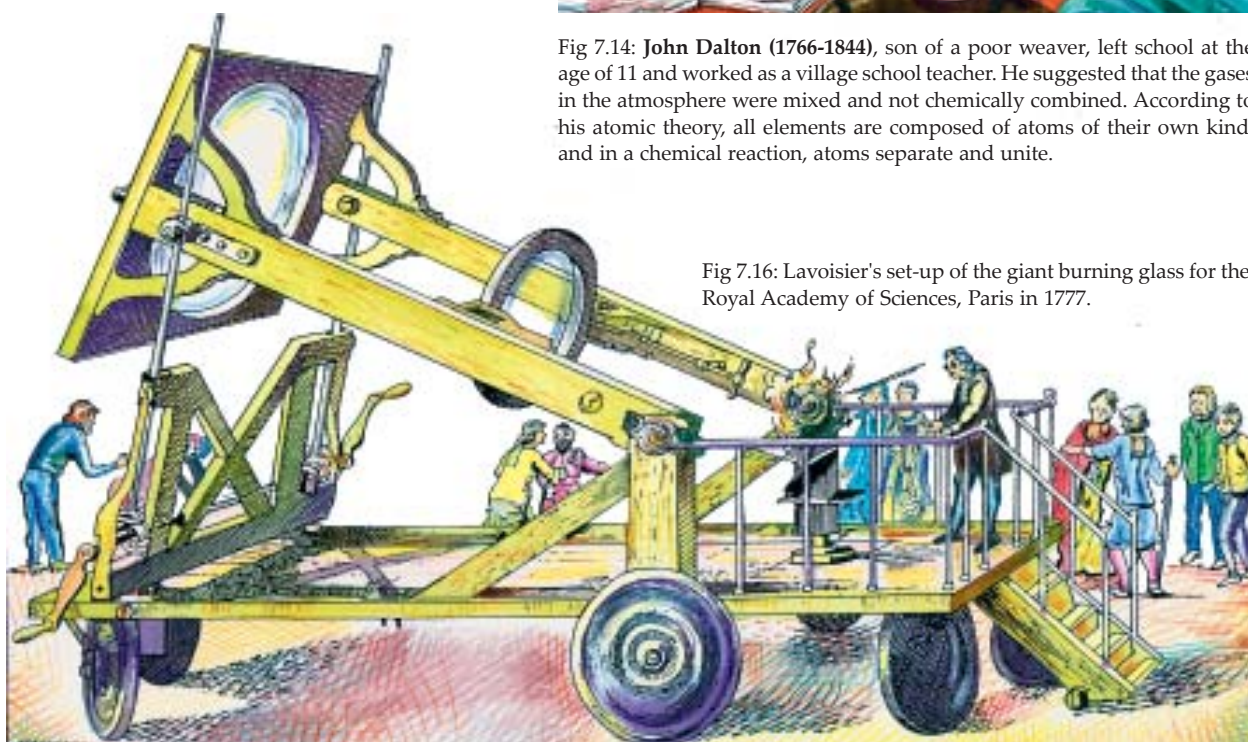

Fig 7.16: Lavoisier's set-up of the giant burning glass for the Royal Academy of Sciences, Paris in 1777.

Periodic Table and Birth of Organic Chemistry

As more and more elements were discovered, chemists began reclassifying the elements. Finally, a fundamental classification based on the atomic weights of the elements was proposed by the Russian chemist, **Dmitri Mendeleev** (1834-1907). Since elements when arranged according to their atomic weights exhibit a remarkable periodicity in their properties, the classification arrived at was aptly called the periodic table.

Surely, chemists did not stop at analysing only the inanimate matter. Organic chemistry, the chemistry of carbon compounds, was born in the 19th century. The most revealing discovery was made by the German chemist **Friedrich Wohler** (1800-82) that urea, an organic compound found in the urine of mammals and other animals, could actually be synthesized from ammonium cyanate, an inorganic compound. This suggested that the chemicals of the living world were indeed composed of the 'ordinary' chemical substances.

Further impetus to this new branch of chemistry was given by the encyclopaedic scholar **Justus von Liebig** (1803-73), who worked with Wohler. Liebig, a great teacher, had many notable organic chemists as his students: **Hofmann** who extracted benzene from coal tar, **Perkin** the founder of the dye industry, and **Kekule** the discoverer of the basic structure of benzene ring. Kekule (1829-96) discovered that the combining power of elements lies in their valency, and that carbon is tetravalent has a fourfold combining power which allows carbon to form long chains (aliphatic) as well as ring compounds (aromatic). Kekule's contribution was fundamental to the phenomenal growth of organic chemistry and biochemistry in the 20th century.

Fig 7.17: The Russian Chemist **Dmitri Mendeleev** (1834-1907) who in 1869 classified the chemical elements in the form of a periodic table.



PERИОДИЧЕСКАЯ СИСТЕМА ЭЛЕМЕНТОВ Д.И.МЕНДЕЛЕЕВА																	
1 H																	2 He
3 Li	4 Be											6 B	7 C	8 N	9 O	10 F	11 Ne
12 Na	13 Mg											14 Al	15 Si	16 P	17 S	18 Cl	19 Ar
20 K	21 Ca	22 Sc	23 Ti	24 V	25 Cr	26 Mn	27 Fe	28 Co									
29 Cu	30 Zn	31 Ga	32 Ge	33 As	34 Se	35 Br	36 Kr										
37 Rb	38 Sr	39 Y	40 Zr	41 Nb	42 Mo	43 Tc	44 Ru	45 Rh	46 Pd								
47 Ag	48 Cd	49 In	50 Sn	51 Sb	52 Te	53 I	54 Xe										
55 Cs	56 Ba	57 La	58 Hf	59 Ta	60 W	61 Re	62 Os	63 Ir	64 Pt								
69 Au	70 Hg	71 Tl	72 Pb	73 Bi	74 Po	75 At	76 Rn	77 U									
79 Fr	80 Ra	81 Ac	82 Ku														
LANTHANIDES																	
Ce	Pr	Nd	Pm	Sm	Eu	Gd	Tb	Dy	Ho	Er	Tm	Yb	Lu				
ACTINIDES																	
Th	Pa	U	Np	Pu	Am	Cm	Bk	Cf	Es	Fm	Md	(No)	(Lr)				



Fig 7.18: **Friedrich Wohler (1800-1882)** extracted and crystallised urea from a dog's urine and also synthesized urea from nonorganic sources. He and Liebig showed that simple elements can combine in several ways to produce a variety of compounds.



Fig 7.19: **Wohler's Laboratory** was equipped with the finest apparatus of the time. It served as a model laboratory for other universities in the 19th century.



Crystals of Urea

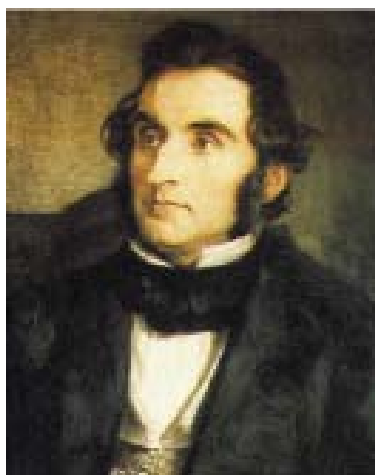

Fig 7.20: **Justus von Liebig (1803-1873)**



Fig 7.21: **Liebig's laboratory at the University of Geissen** attracted chemists from all over Europe and America. Liebig was one of the greatest practical chemists of the 19th century. He developed methods for the exact analysis of organic compounds. In his later life, he worked on the use of chemicals in agriculture.

Fig 7.22: Evolution of a few chemical symbols.

	1500s	1600s	1700s	1780	1800s	1818
GOLD						Au
MERCURY						Hg
LEAD						Pb

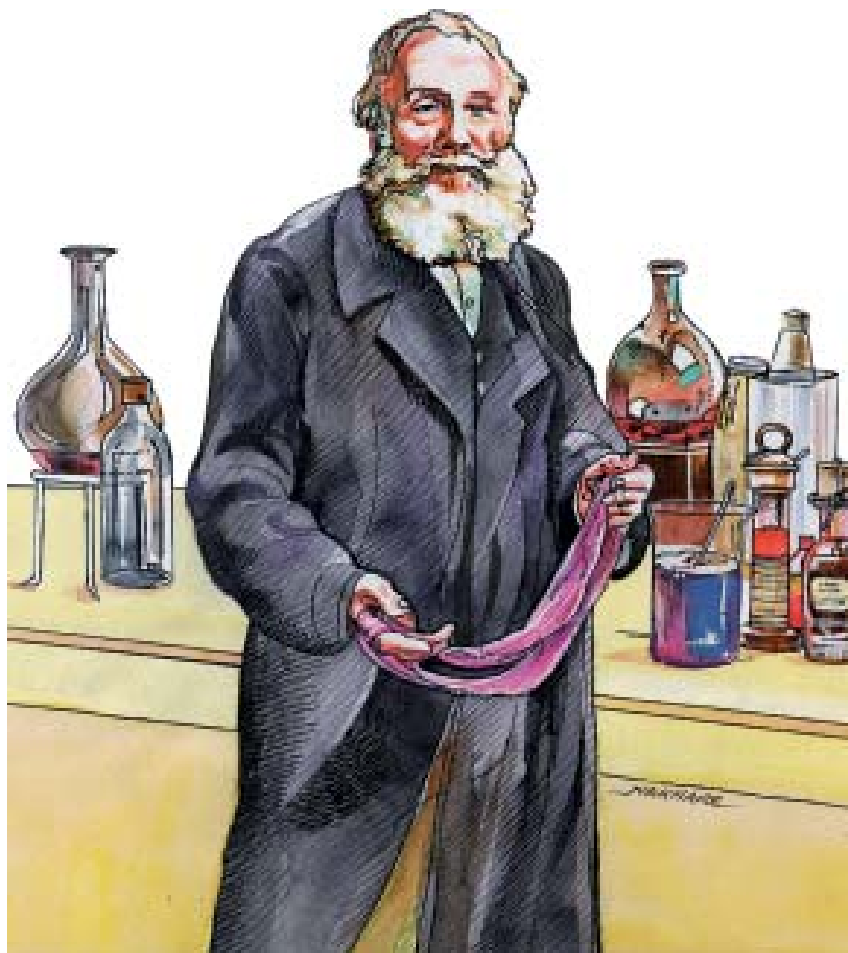

Fig 7.23: **William Henry Perkin's (1839-1907)** discovery of the dye, aniline purple, heralded the birth of the synthetic chemical industry. The first scientist entrepreneur in the western world, he synthesised many chemicals from coal tar including a red dye alizarine, and the first perfume coumarin.

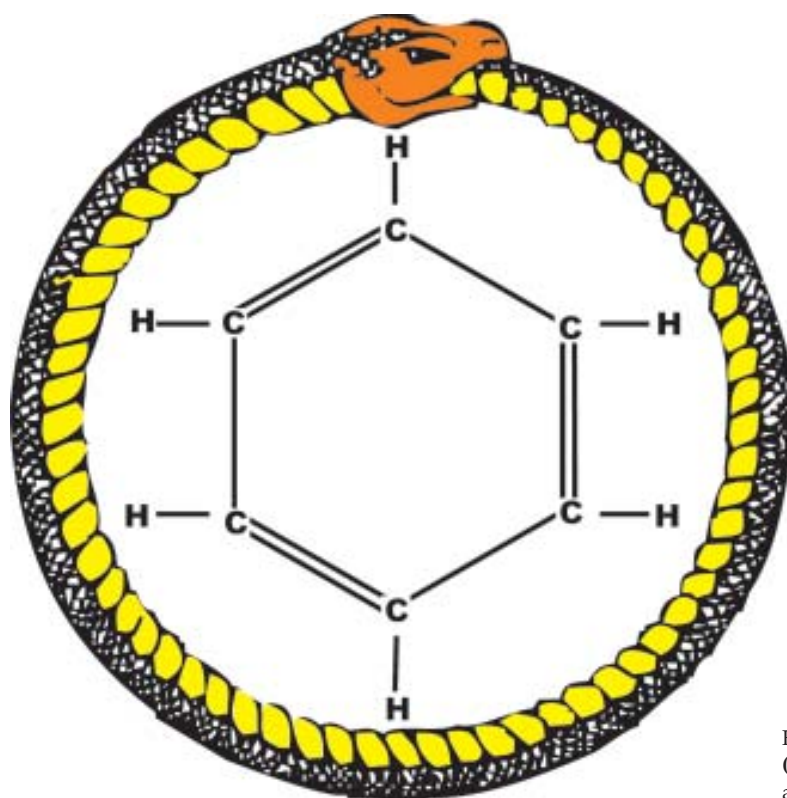

Fig 7.24: **Friedrich August Kekule von Stradonitz (1829-1896)**, proposed the cyclic structure of benzene and stated that carbon is tetravalent.

8

Physics in the Nineteenth Century

Optics

Optical instruments like telescopes and microscopes continued to be developed during the seventeenth and eighteenth centuries. Soon speculations about the very nature of light began to engage every physicist. **Rene Descartes** believed that light was a force caused by the vibrations of particles and suggested that it travelled slower in rarer media like air and faster in denser media. **Christiaan Huygens** (1629-1695) theorised that light is a series of shock waves through aether, an all pervading invisible medium. Huygens argued, contrary

Fig 8.1: **Olaus Roemer** (1644 - 1710), a Danish astronomer, worked in the Royal observatory at Paris. He noticed that the time elapsed between the eclipses of Jupiter's moons by Jupiter became shorter as Earth moved closer to Jupiter and became longer as Earth and Jupiter drew farther apart. He deduced that the difference was caused by the time needed for light to cross the increased distance between the two planets. In 1676 using this observation he estimated the speed of light as 225,000 km per second (modern measurement is 299,792 km per second). This contradicted his contemporaries who believed that light travelled with infinite speed.

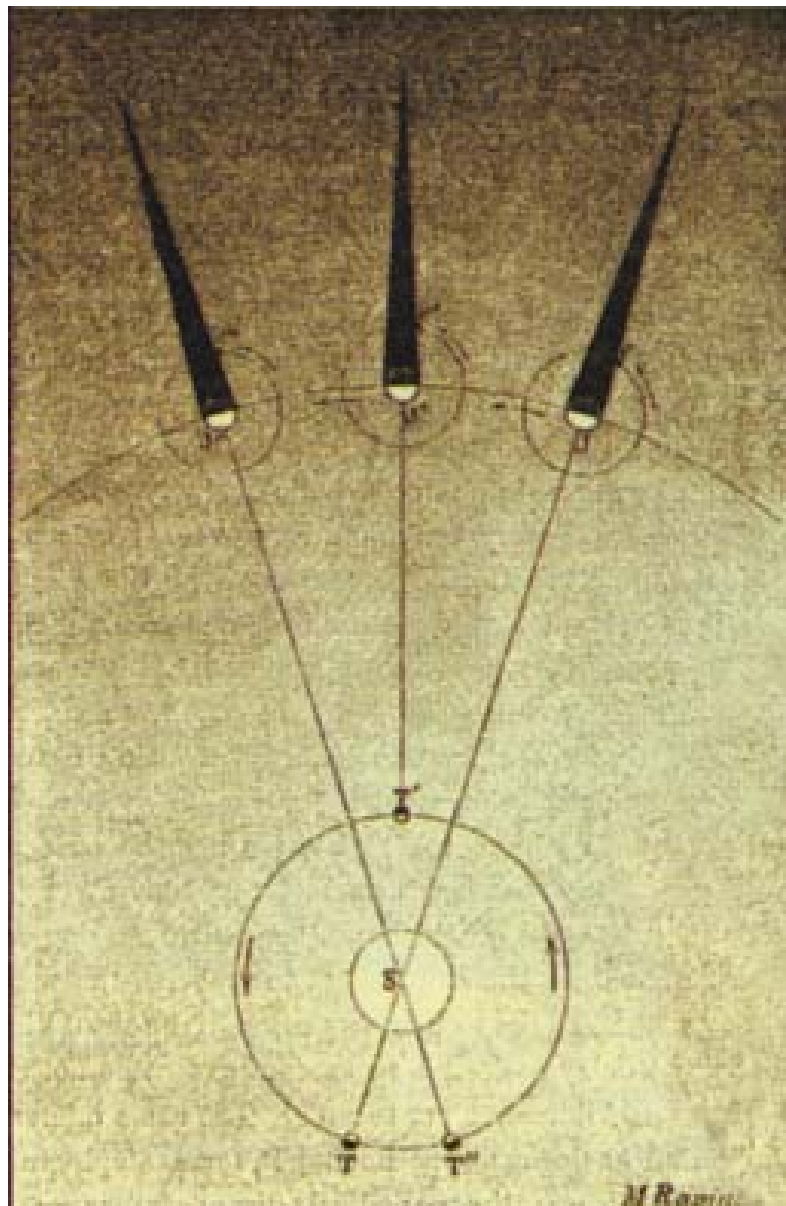

to many of his contemporaries, that light did not travel with infinite speed. **Isaac Newton** and **Edmund Halley** criticized Huygens' theory, for it could not explain double refraction. Newton's view was that light is a stream of 'corpuscles'. The view gained wider acceptance because of the atomic world view that was steadily gaining greater ground among scientific circles. Also, Newton's successful results on the composition of light, his invention of the reflecting telescope, and the influence he enjoyed, prevented many from seeing the truth of the wave nature of light until the nineteenth century.

The first breakthrough in favour of the wave theory was due to **Thomas Young**, who explained all the effects of reflection and refraction using wave theory. He proposed that the colour of light is due to the specific wavelength of its waves. He further discovered and explained the phenomenon of 'interference of light', which could not be explained by the corpuscular theory. But the phenomena of 'double refraction' and 'diffraction' still needed explanation. The *Academie des Sciences* in 1808 offered prizes to anyone who could come up with a theory to explain these phenomena. Two years later **Etienne-Louis Malus** (1775-1812) discovered 'polarization', a special effect of 'double refraction' and explained it on the basis of corpuscular theory and won the prize. But soon **Augustin Fresnel** (1788-1827) explained 'diffraction' using wave theory and also won the prize of the Academy. Later, Fresnel and Young jointly proposed the idea that light waves are transverse and not longitudinal in nature. Using this idea they could explain most of the experimental results on light.



Fig 8.2: **Christiaan Huygens** (1629-1695) was a brilliant Dutch mathematician, physicist and astronomer. He rejected Newton's particle theory of light and put forward the wave theory of light in 1690. He is also known for inventing a pendulum clock with increased accuracy.

Fig 8.3: **An experiment performed by Thomas Young showing interference of light:** Light of a particular wavelength passes through the slit (S) and is intercepted by two other slits (P1 and P2), about 1mm apart, which act as secondary sources of coherent, semi-cylindrical waves of light. The waves combine to form an interference pattern on the plane screen.

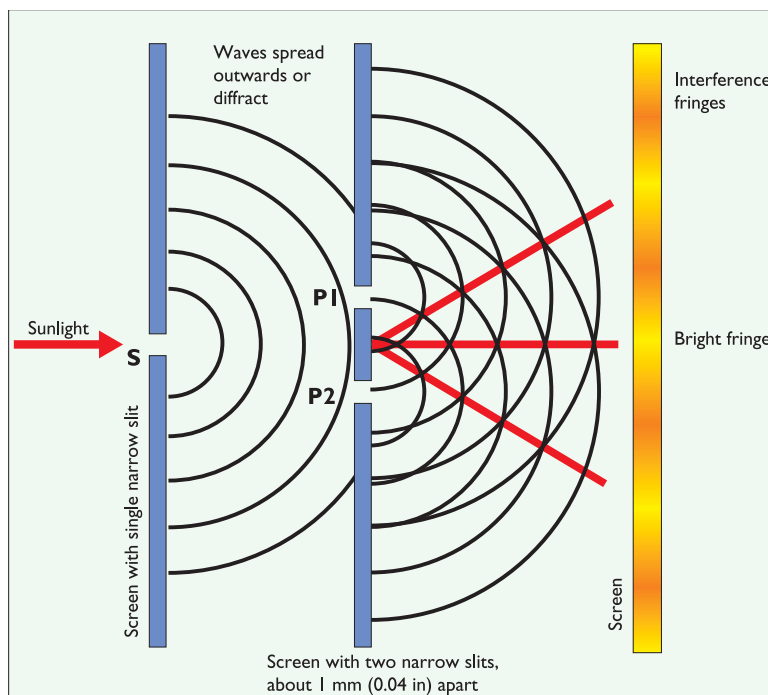

Fig 8.4: **Thomas Young** (1773-1829), an English physician as well as a physicist worked with Fresnel to demonstrate that light travels in the form of transverse waves, thereby disproving the corpuscular view of light. He discovered the phenomenon of interference and explained it using the wave theory of light.





Fig 8.5: **Augustin Jean Fresnel (1788-1827)** was a French physicist credited with the invention of unique compound lenses designed to produce parallel beams of light widely used in lighthouses. He explained the phenomenon of diffraction and won the prize of the French Academy of Sciences.



Fig 8.6: **Joseph von Fraunhofer (1787-1826)**: A son of a poor glass-grinder, Fraunhofer, shown left in the picture, plotted the Sun's spectrum in 1814.

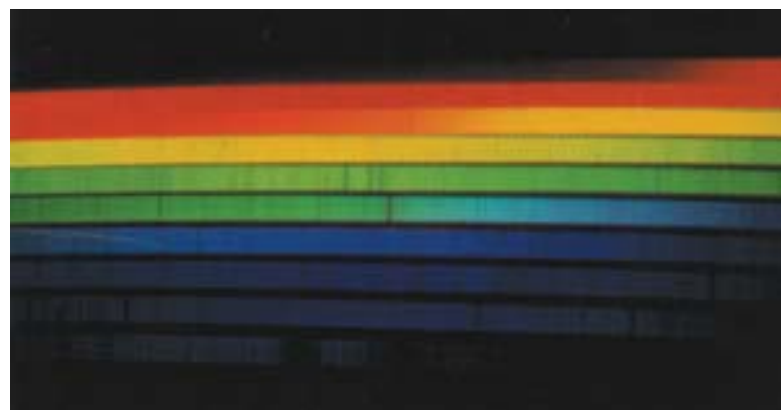
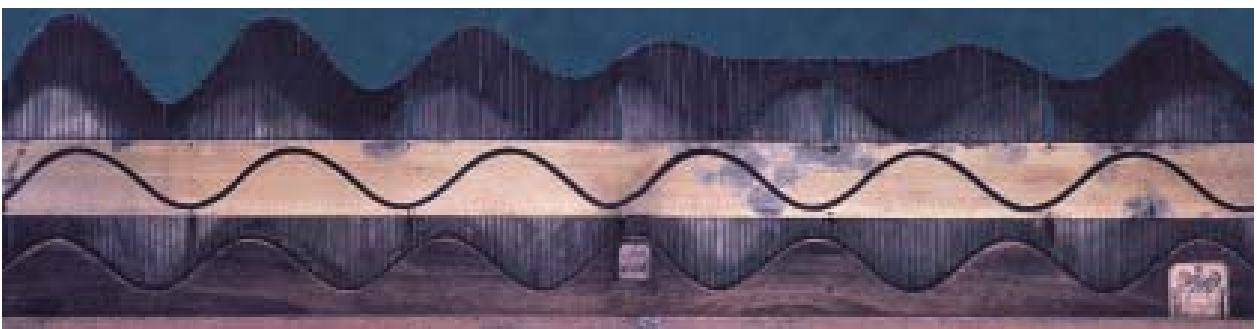

Fig 8.7: **Fraunhofer lines**: When light travels through cooler atoms in the Sun's outer atmosphere, some of its wavelengths are absorbed. Each kind of atom in the outer atmosphere absorbs specific wavelengths of light producing characteristic gaps in the absorption spectrum.

Fig 8.8: An 18th century apparatus showing the interference effect.



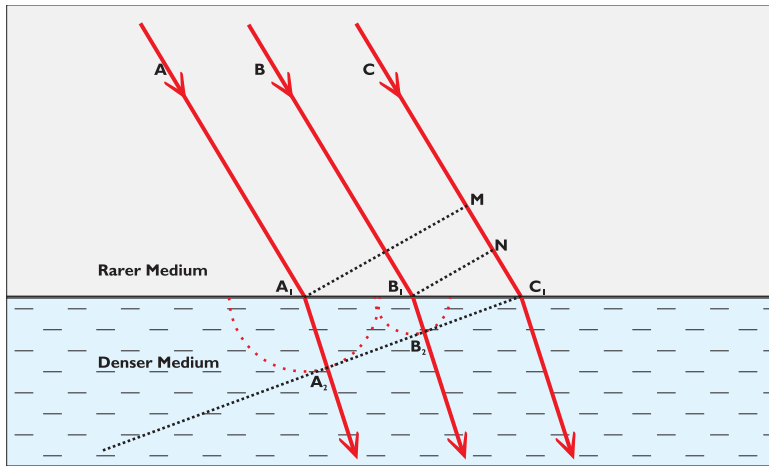

Fig 8.9: **Willebrord van Roijen Snell (1580-1626)**: In 1621, this Dutch mathematician and astronomer discovered the simple relationship between the angle of incidence and the angle of refraction for a ray of light crossing from one medium to another. Later, Descartes defined the refractive index of a medium based on Snell's discovery.

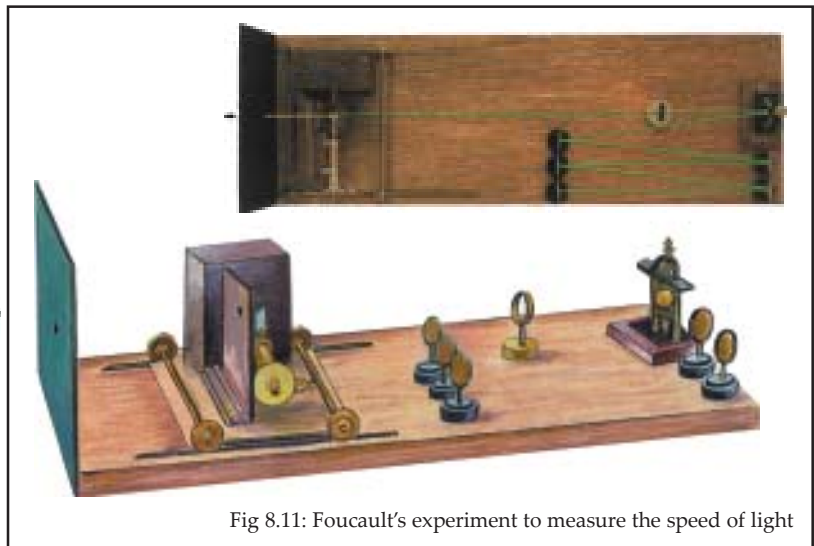

Fig 8.11: Foucault's experiment to measure the speed of light

Fig 8.10: **Leon Foucault (1819-1868)**, developed a way to measure the speed of light with extreme accuracy. He proved that the speed of light is greater in air than in water.

Electricity and Magnetism

Notions of electricity and magnetism existed even before the experimental study of static electric charges began during the 17th and 18th centuries. Devices such as the Leyden jar were developed by the amateur scientists and in 1752 **Benjamin Franklin** demonstrated that the electricity in the atmosphere could be conducted to the ground through metallic wires. Extensive experimental work by **Otto von Guericke (1602-86)**, **Stephen Gray (1666-1736)**, **Henry Cavendish (1731-1810)**, **Charles Coulomb (1736-1806)** and **Luigi Galvani** preceded **Alessandro Volta's** first chemical cell using copper and zinc disks separated by moist cardboards.

The concept of electric current was developed mainly through the efforts of **Georg Ohm (1789-1854)** and **Gustav Kirchhoff**. **Hans Oersted (1777-1851)** discovered the magnetic effect of electric current in 1820. This magnetic field 'without a magnet' intrigued many scientists, and the relationship between electric current and



Fig 8.12: Lightning conductor



Fig 8.13: **Benjamin Franklin (1706-90)**, an American statesman and inventor, studied the nature of electricity. He suggested the names 'positive' and 'negative' for the two opposite charges.



Fig 8.14: **Franklin with kite**: In 1752, Franklin proposed that lightning was electricity and proved it by hanging a key (lightning conductor) from a kite in a thunderstorm. Fortunately, the experiment did not kill him.

Fig 8.15: **Electroscope** is an important instrument for detecting electric charge. A positively charged resin rod is held near the top of the electroscopes. The metal rod of the electroscopes gets negatively charged, leaving excess positive charges on the gold leaves, as a result of which the leaves repel each other. The electroscopes were originally invented by **William Gilbert** who also coined the term electricity in the seventeenth century.



magnetism became a serious area of investigation. It led **Michael Faraday** to probe the converse phenomenon, namely, the electric effect of magnetism. Faraday did not find any effect with stationary magnets, but when he moved a magnet near a loop of wire, a current was generated in the loop. This was the electromagnetic induction discovered by Faraday in 1854.

Taking clues from Faraday's work, **William Thomson (Lord Kelvin)** used the analogy of an elastic medium (aether) to explain the propagation of electric effects. **James Clerk Maxwell** developed an outstanding mathematical treatment on the subject: the theory of electromagnetic radiation. In 1888, **Heinrich Hertz (1857-94)** demonstrated the existence of electromagnetic waves as predicted by Maxwell's equations. He showed that these waves are reflected, refracted and diffracted just the way light is. This unified not only electricity and magnetism but also light. While Newtonian mechanics had to be modified with the advent of Einstein's theory of special relativity, Maxwell's theory not only survived, but served as a basis for Einstein's theory of relativity.

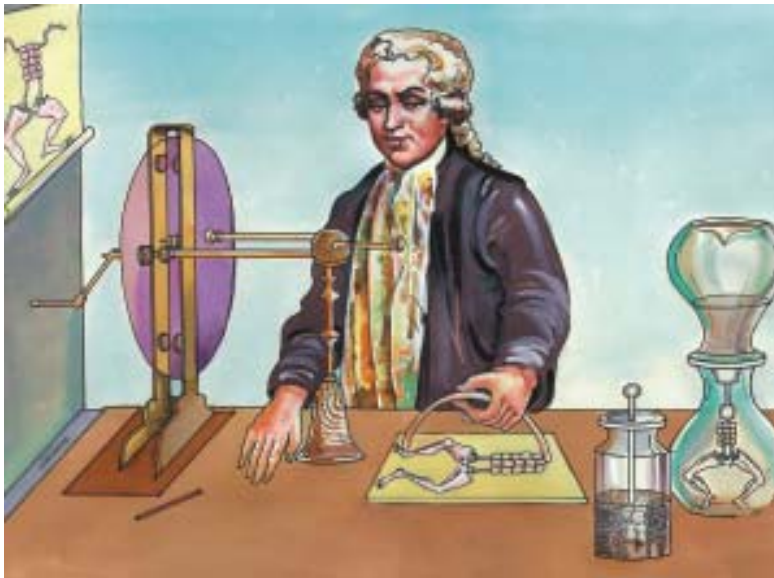

Fig 8.16: **Luigi Galvani (1737-1798)**, an Italian anatomist, while dissecting and studying a frog, noticed that when his sharp scalpel touched the nerves in the frog's leg, the leg twitched. He experimented further to explain the electricity in the frog's muscles. Galvani thought that this electricity came from animals' bodies, and he called it animal electricity. Also shown in the picture is a Leyden jar, used by Galvani for the supply of electricity.

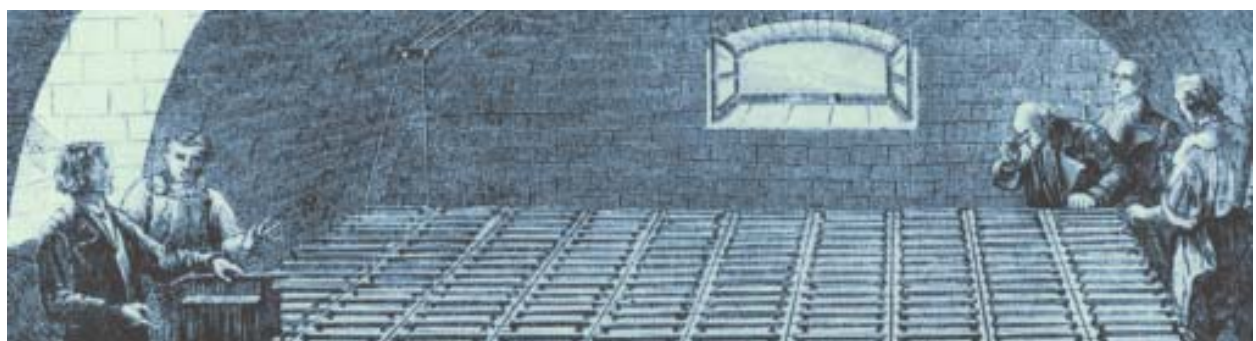

Fig 8.17: **Leyden jar**



Fig 8.18: **Alessandro Volta (1745-1827) and the Pile:** Volta used three components to make a cell: zinc, cardboard/leather (soaked in a salt solution or vinegar) and copper. He piled these cells and produced the first chemical battery in 1800.

Fig 8.19: A room full of 2000 cells used by Humphry Davy to produce electricity.



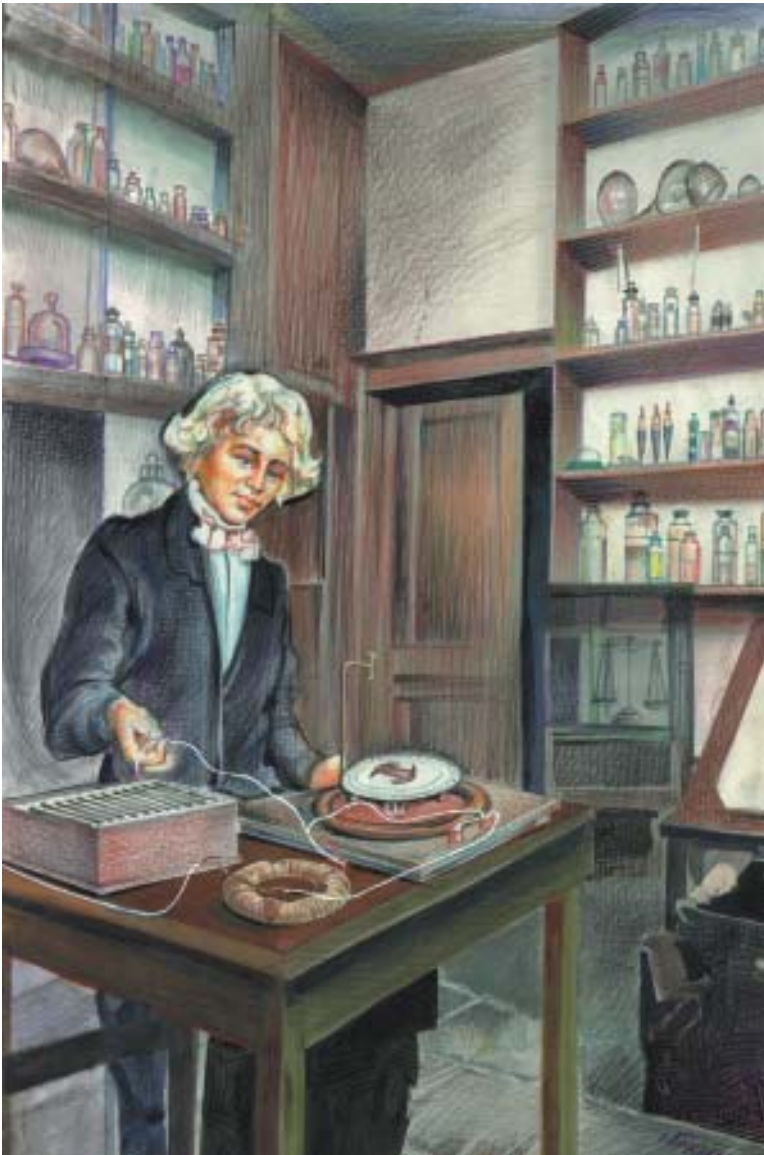

Fig 8.20: Induction coil (Faraday's Ring)

Fig 8.21: **Michael Faraday (1791-1867)**: Faraday is regarded as one of the most outstanding experimenters of all time. Son of a blacksmith, he started work as a bookbinder's apprentice at the age of 14. This gave him the opportunity to read books and soon science began to fascinate him. He initially worked as an assistant to **Humphry Davy**, and rose to become the Director of the laboratory at the Royal Institute in London. Among his several pioneering discoveries is the law of electromagnetic induction. The picture shows the induction coil which he constructed for demonstrating magnetic effects of electric current.

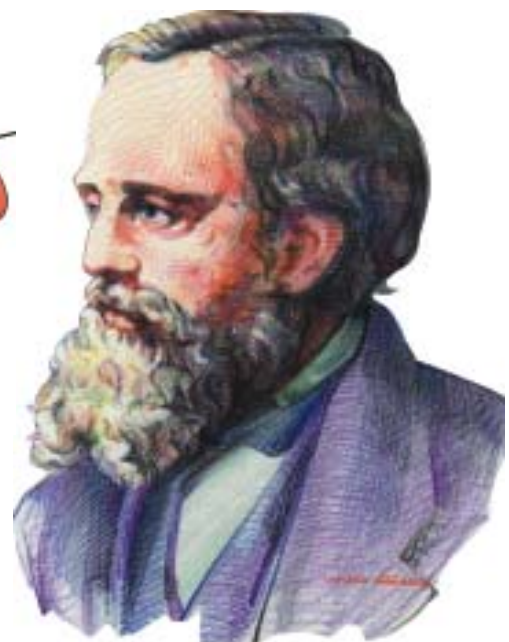
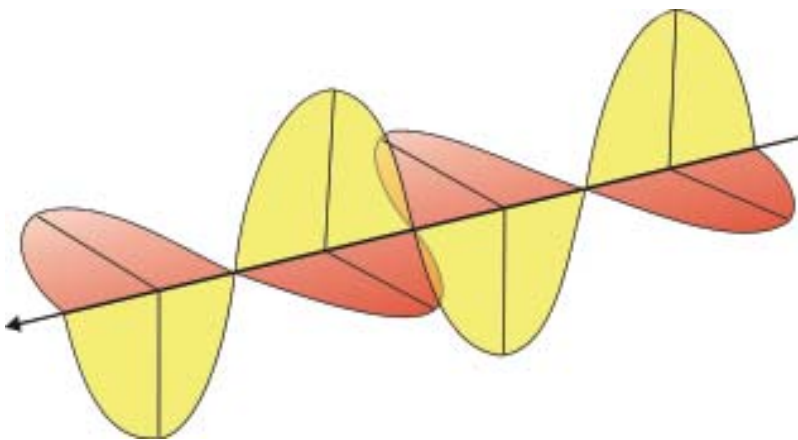

Fig 8.22: **James Clerk Maxwell (1831-1879)**, gave the mathematical theory of electrodynamics, and proved that light is electromagnetic radiation. In 1865, he predicted the existence of invisible electromagnetic radiations. The successful production of radio waves in 1880 by Hertz was a triumph of Maxwell's theory. The theory spurred fundamental development that eventually led to Einstein's special theory of relativity with which it is consistent.

Thermodynamics

The early scientific study of heat consisted in inventing a method of measuring it. Though attempts to measure heat began with **Galileo Galilei**, the breakthrough was made by **Olaus Roemer** who constructed an alcohol based thermometer with upper and lower fixed points. All subsequent thermometers, developed first by **Daniel Fahrenheit** (1686-1736) and later by **Anders Celsius** (1701-1744) and **Rene-Antoine Ferchault de Reaumur** (1683-1757) were based on Roemer's idea of the two fixed points. The original Celsius scale used 0 degree for the boiling point and 100 degrees for the freezing point of water. The scale was later inverted by the Swedish biologist **Carl Linnaeus** to give us the present Celsius thermometer.

The development of thermometry stimulated quantitative research in heat despite disagreements on its nature. **Pierre Gassendi**, **Francis Bacon** and **Robert Hooke** argued that heat originated due to vibrations of the parts of a substance, while **Antoine Lavoisier** and **Claude Louis Berthollet** (1748-1822) among several others held that heat is an 'imponderable' fluid called 'caloric'. The earlier belief that different bodies at the same temperature hold the same quantity of heat was falsified by the experimental work of **Joseph Black**. He defined the concept of 'specific heat' and 'latent heat'. Black's work aided the invention of steam engine by **James Watt** (1736-1819).



Fig 8.23: Galileo's thermoscope

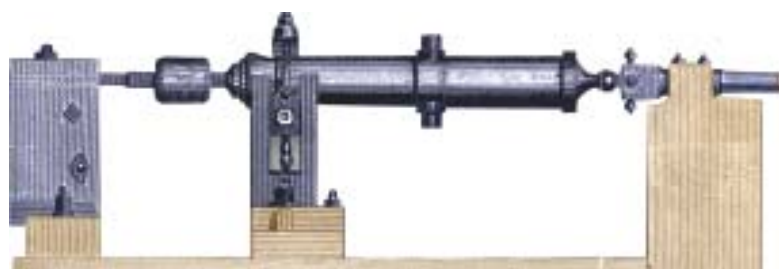

Fig 8.24: Count Rumford (1753-1814) and his apparatus

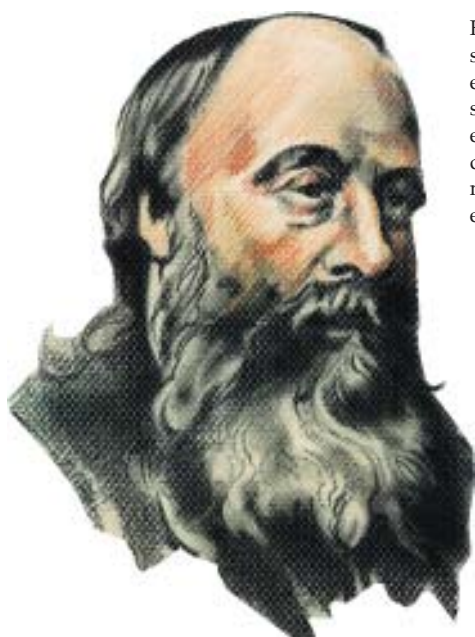

Fig 8.25: **James Prescott Joule** (1818-1889) studied under Dalton and started experimenting on the constitution of gases. He studied the work done by a gas when it expands and the heat generated when it is compressed. His work formed the basis of the modern concept of energy. Hence the unit of energy has been named as 'joule' after him.



Fig 8.26: Joule experimentally measured the work required to generate heat. Falling weights turned the paddles in a container of water. The water became hot due to friction. Joule measured the rise in temperature of the water and calculated the heat generated.



Fig 8.27: Rudolf Julius Emanuel Clausius (1822-1888) was a German theoretical physicist who made important contributions to thermodynamics. He worked with the results of Joule and Carnot and formulated the first two laws of thermodynamics.

The first blow to the caloric theory came at the end of the eighteenth century when **Sir Benjamin Thomson (Count Rumford)** experimentally demonstrated that an inexhaustible amount of heat can be produced by mechanical work done against friction. **Sadi Carnot** furthered the progress by analysing the energy dynamics of steam engines. He stated that the mechanical work an engine does is due to the fall in its temperature and not due to loss of the 'caloric'. He further asserted that in an ideal engine heat is neither created nor destroyed, and believed that heat is nothing but 'motive power'. Through a series of careful experiments, **James Joule** conclusively identified heat as a form of energy. **Julius Robert von Mayer** (1814 -1878) proposed that heat and work are interchangeable and in 1842 derived the value for the mechanical equivalent of heat. **Lord Kelvin** attempted to formulate Joule's work in precise mathematical terms, and in the process invented the independent absolute scale of temperature. Around 1850 the German physicist **Rudolf Clausius**, while investigating the relationship between the flow of heat and mechanical work on the lines suggested by Carnot, formulated the two laws of thermodynamics. The work of Clausius and Kelvin made it clear that heat was not a mysterious fluid but a form of energy.

Ludwig Boltzmann utilized statistical methods to show how the second law of thermodynamics can be explained by applying the laws of mechanics and the theory of probability to the motions of atoms, the constituents of matter. He thus founded the discipline of statistical mechanics. This discipline was greatly extended through the work of **Josiah Willard Gibbs** (1839-1903) who successfully applied it to chemical phenomena. The techniques of statistical mechanics established by these pioneers have survived the revolutionary transition from classical to quantum physics and remain useful till today.

Fig 8.28: **Carnot Cycle**: In process **A → B**, the gas expands isothermally while in contact with a reservoir at T_h . In process **B → C**, the gas expands adiabatically ($Q=0$). In process **C → D**, the gas is compressed isothermally while in contact with a reservoir at $T_c < T_h$. In process **D → A**, the gas is compressed adiabatically. The arrows on the piston indicate the movements of the piston.



Fig 8.29: Nicolas Leonard Sadi Carnot (1796-1832): His approach to the study of heat and motion led to the second law of thermodynamics.

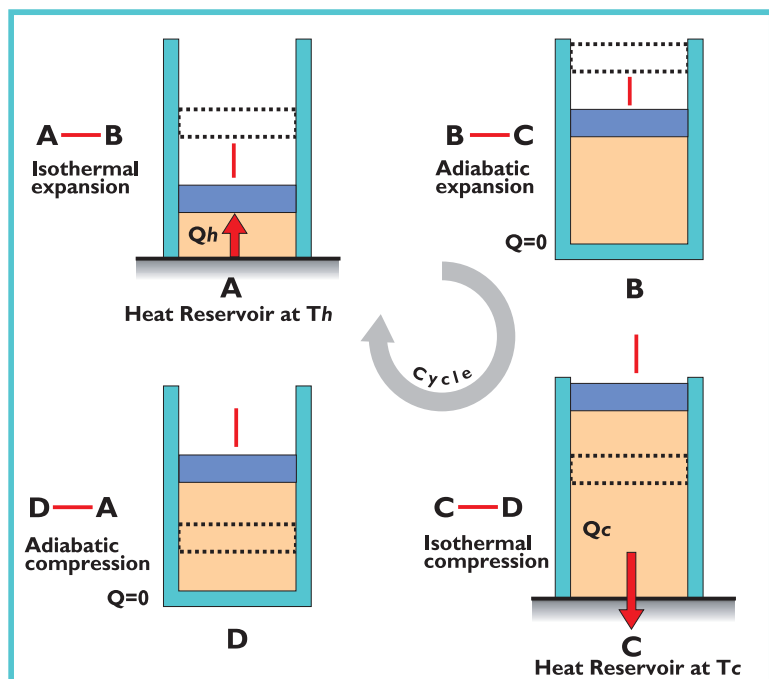



Fig 8.30: Otto von Guericke's experiment to demonstrate the strength of a vacuum, using two 'Magdeburg' hemispheres of brass from which air had been exhausted.

Second Law of Thermodynamics:

According to Kelvin: No process is possible whose sole result is the absorption of heat from a reservoir and the conversion of this heat into work.

According to Clausius: No process is possible whose sole result is the transfer of heat from a cooler to a hotter body.



Fig 8.31: **William Thomson (Lord Kelvin) (1824-1907):** He introduced the absolute scale of temperature in 1847, later known as Kelvin scale. His work in thermodynamics helped him establish the law of conservation of energy which was proposed by Joule. He was also the co-discoverer of what is known as the "Joule-Thomson Effect" in gases.



Fig 8.32: **Ludwig Boltzmann (1844-1906)** discovered the links between thermodynamics and the kinetic theory of gases. His work in statistical mechanics is a bridge between the classical physics of the 19th century, and the quantum physics of the 20th century.

Fig 8.33: **Hermann Ludwig Ferdinand von Helmholtz (1821-1894)** expressed the relationship between mechanics, heat, light, electricity, and magnetism by treating them all as divisions of a single force. He presented a mathematical proof for his 'Law of Conservation of Force' in 1847. His use of the word 'force' corresponds to what later became known as energy.

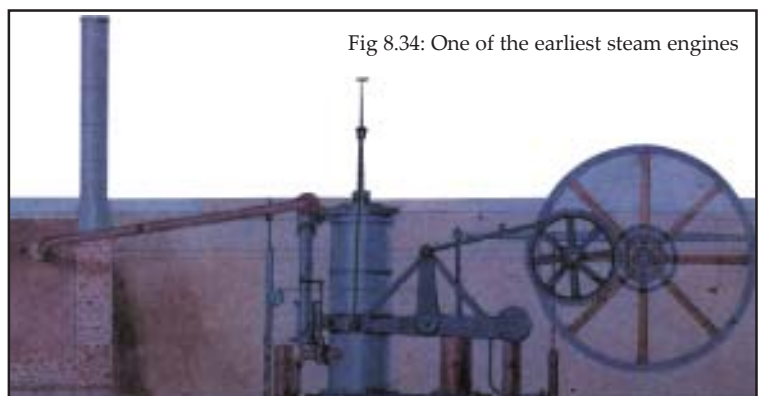

Fig 8.34: One of the earliest steam engines



Fig 8.35: Sir William Crookes (1832-1919) followed the observations made by Faraday in 1838 by passing electricity through highly evacuated discharge tubes. He named the stream of particles that came out of the negative end of the tube as 'cathode rays'. Also shown in the picture is the apparatus used by him to demonstrate that cathode rays can cast shadows.

The Beginnings of Atomic Theory

A spate of events in close succession beginning 1895 marked the birth of modern physics. Among them were the discoveries of X-rays, electron, radioactivity and, somewhat later (in 1911), the discovery of the nuclear model of the atom. These developments were rooted in more than half a century of experiments on discharge of electricity through liquids and gases. Faraday established the elegant vocabulary for the subject in terms of 'electrolysis' 'cathode,' 'anode,' 'ions' and many others, and discovered the quantitative laws of electro-chemical decomposition in 1833. In 1838 he studied electric discharges in a vacuum and discovered the "Faraday dark space" near the cathode. **George Johnstone Stoney** (1826- 1911) measured the unit of electrical charge in 1874, but it was not associated then with the electron.



Fig 8.36: **John Joseph Thomson** (1856-1940) was the professor of physics at the Cavendish Laboratory at Cambridge University. His experiments with the cathode tube yielded pioneering results including the ultimate discovery of electron in 1897. Shown in the picture is the discharge tube used by him with the additional setup to study the electromagnetic effects on the cathode rays.

The invention of new vacuum pump by **Heinrich Geissler** (1815-79) in 1855 helped **Julius Plucker** (1801-68) to show that there is an extended glow on the glass walls of the discharge tube at very low pressures. This was attributed to some radiation (cathode rays) impinging on the walls of the tube. Further experiments by **William Crookes** demonstrated that the cathode rays were negatively charged particles, and they cast shadows. **J. J. Thomson** measured their velocity and found that it was 1600 times slower than light, resting the view that cathode rays are a kind of electromagnetic radiation. He also measured to reasonable accuracy the charge to mass ratio (e/m) of the proposed particles. This proved beyond doubt that there existed particles smaller than atoms.

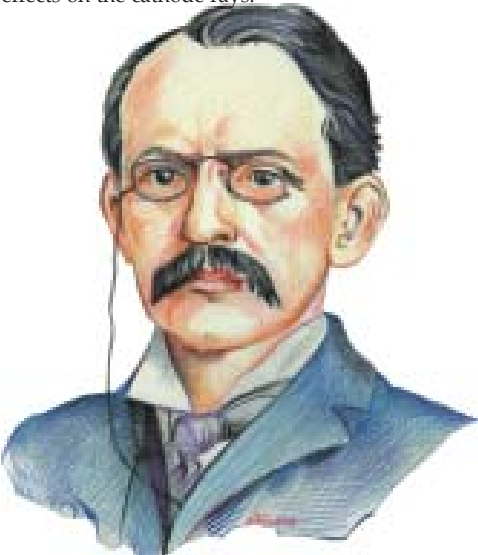

In 1895 **Wilhelm Roentgen** accidentally discovered X-rays by impinging cathode rays upon metals. **Henri Becquerel**, a French physicist, discovered that the heavy element uranium was continuously emitting rays. **Ernest Rutherford** figured out in 1903 that radioactivity produced two kinds of rays, and **Frederick Soddy** (1877-1956) confirmed that they are actually particles. Rutherford collaborated with **Hans Geiger** (1882-1945) and performed the famous scattering experiment of alpha particles, which suggested that most of the atom is empty. The once 'indivisible' atom was seen to have an inner structure.



Fig 8.38: The first X-ray picture made by Roentgen of his wife's hand showing the bones and the ring.



Fig 8.37: **Wilhelm Konrad Roentgen (1845-1923)**, a professor of Physics at Wurzburg, accidentally discovered that some rays were escaping the cathode ray tube which could fog photographic plates covered through black paper. He called them 'X-rays'. J. J. Thomson discovered later that Xrays are generated when fast moving electrons strike on metals.

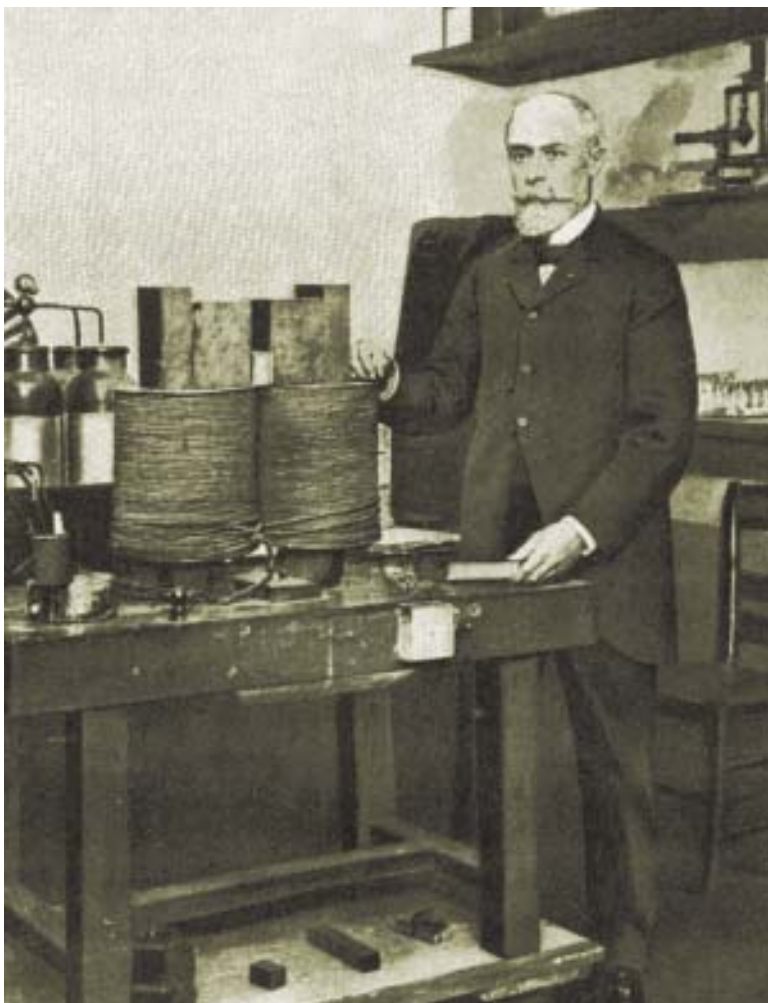

Fig 8.39: **Henri Becquerel (1852-1902)** at the the hint of Henri Poincare, the famous French mathematician, looked for any connection between X-rays and phosphorescence. He discovered that the rays emanating spontaneously from uranium nitrate were also capable of penetrating matter like X-rays. This phenomenon was later called 'radioactivity' by the Curies.

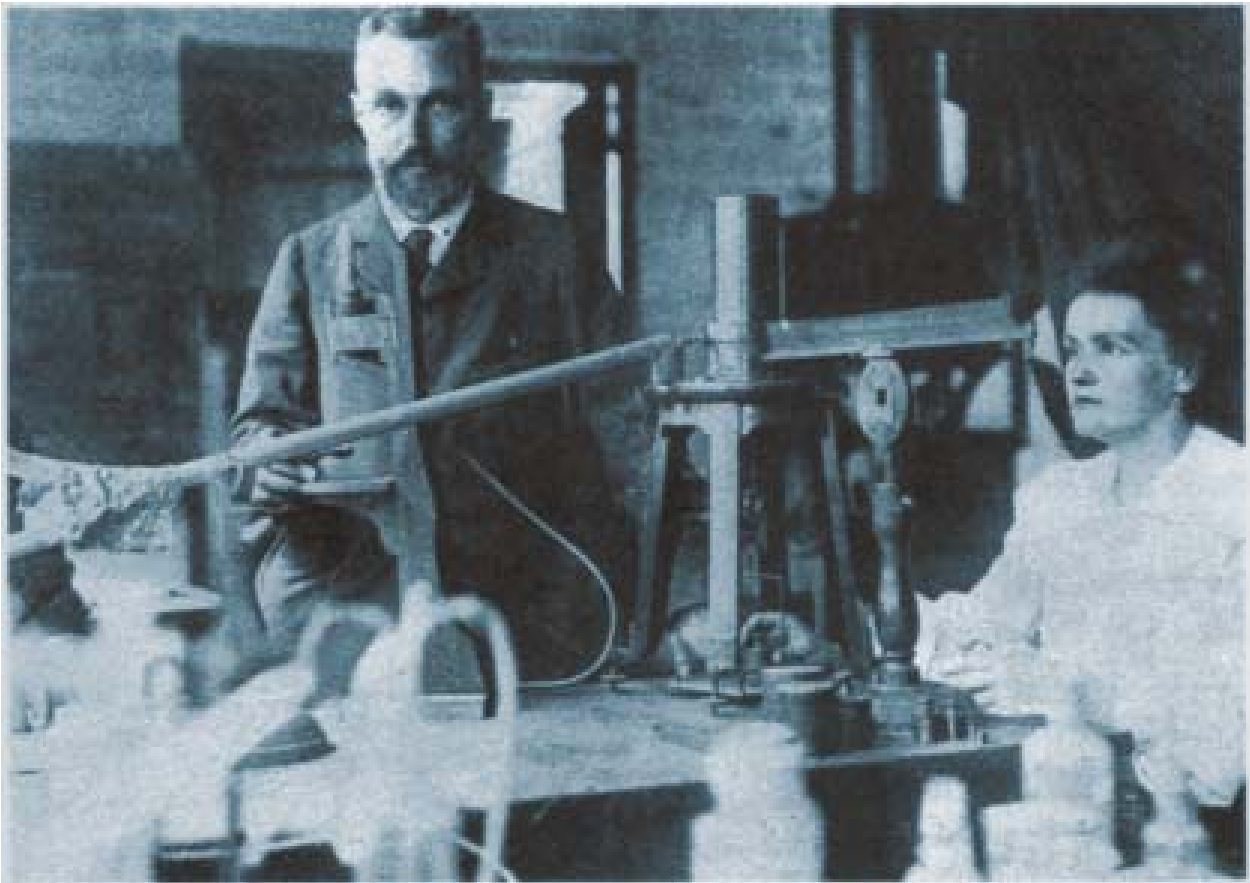
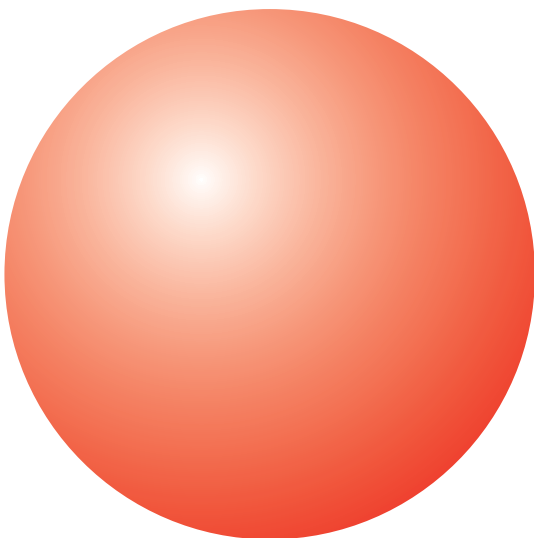

Fig 8.40: **Pierre Curie (1859-1906) and Marie Curie (1867-1934)**, the husband and wife team, working in a laboratory at the School of Physics and Chemistry in Paris, discovered radiation from the mineral pitchblende. After prolonged painstaking chemical extraction process they managed to isolate two radioactive elements, which they named 'polonium' and 'radium.'

Fig 8.43:

Dalton: 'Billiard ball' 1803



Thomson: 'Plum pudding' 1901

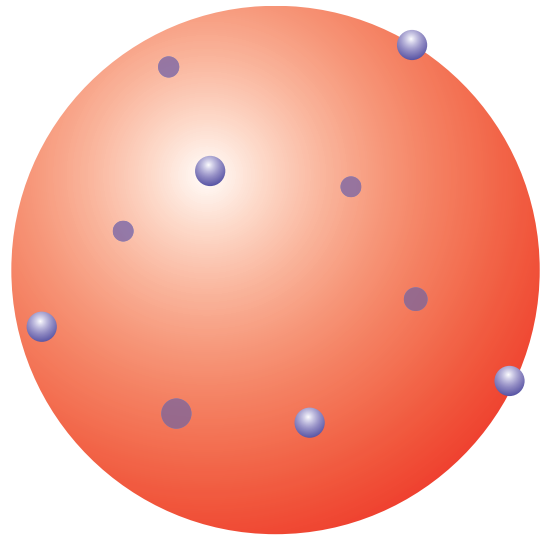

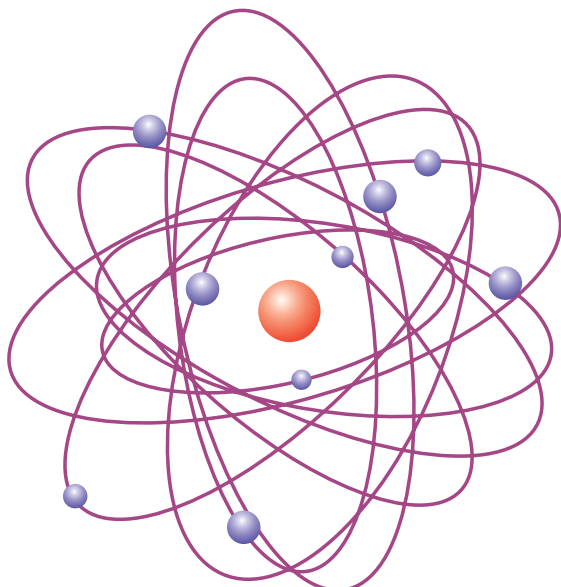

Fig 8.41: The Cavendish Laboratory, where Ernest Rutherford and J. J. Thomson did their experiments

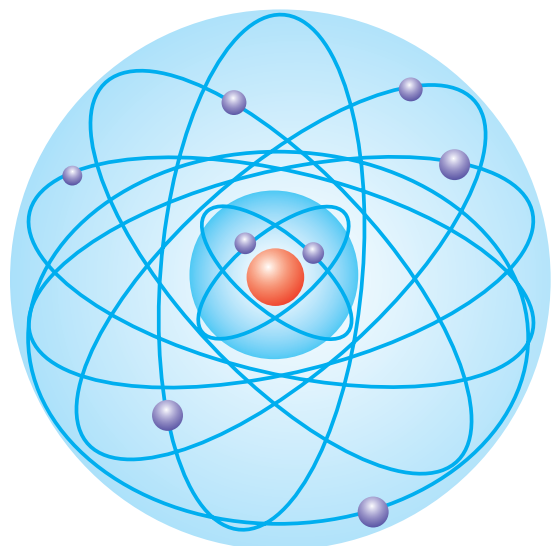

Fig 8.42: **Lord Rutherford (1871-1937)** worked at J. J. Thomson's laboratory at Cambridge, where he experimented extensively on radioactivity, and discovered the alpha and beta 'rays.' With his collaboration with Frederick Soddy he realized that the 'rays' coming out of radioactive substances included particles.

Rutherford: 'Nuclear Model' 1911



Bohr: 'Shell' 1913



9

Progress in Mathematical thought



Fig: 9.1: **Sophie Germain (1776-1831)** was a renowned French mathematician. She won the *Grand Prix* of the Parisian *Academie des Sciences* in 1816 for her work in number theory and elasticity. Sophie had to do her course work under a masculine pseudonym as the *Ecole Polytechnique* in Paris was closed to women at that time.

Mathematics in the nineteenth century and beyond underwent an explosive growth. Complex function theory founded by **Augustin-Louis Cauchy** (1789-1857) to which **Karl Weierstrass** (1815-97), **Niels Abel** (1802-29), **Carl Jacobi** (1804-51) and **Bernhard Riemann** (1826-66), among others, contributed, was the most important technical achievement of the century. Progress was made on a variety of fronts. Algebraic number theory was inaugurated through the work of **Ernst Kummer** (1810-93), **Richard Dedekind** and later by **David Hilbert**. The theory of forms systematised by Gauss became a major area of work. Attempts to prove the prime number theorem brought analysis to number theory.

In geometry, synthetic projective geometry was revived by **Gaspard Monge** (1746-1818) and his pupils **Lazare Carnot** (1753-1823) and **Jean Poncelet** (1788-1867). In parallel, the use of algebraic methods to treat the same subject initiated by **August Mobius** (1790-1868) and **Julius Plucker** (1801-68) ultimately came to dominate the field. In time, through the work of **Arthur Cayley** (1821-95) and later by **Felix Klein** (1849-1925), projective geometry acquired a basic status, and the various metric geometries (**Euclidean** and **Non-Euclidean**) were seen to be subsumed by it. Each geometry came to be associated with a group of transformations and their invariants. The study of algebraic invariants under more general transformations than linear transformation eventually led to a most subtle field of contemporary mathematics: algebraic geometry.

Some of the most consequential thoughts of 19th century mathematics concerned the possibility of Non-Euclidean geometry conceived by **Carl Gauss**, **Nikolai Lobachevsky** and **Farkas Bolyai** (1775-1856). This followed from the realization that Euclid's parallel axiom could not be proved from his remaining axioms. Replacing this axiom by another could, therefore, generate new geometries

Fig: 9.2: **Nikolai Lobachevsky (1792-1856)**



Non-Euclidean Geometry:

1. The angle sum of a triangle is less than (greater than) 180 degrees in Lobachevskian (Riemannian) geometry.
2. The formula $C = 2\pi r$ for circumference of a circle of radius r is replaced by: $C = \pi k (e^{r/k} - e^{-r/k})$ (k , constant) in Lobachevskian geometry. The Riemannian formula for C cannot be expressed in simple terms.

Non-Euclidean geometry was created mainly by Gauss, Lobachevsky, Bolyai and Riemann.

Prime Number Theorem :

There are no simple formulae for the n th prime and for the exact number of primes among the first n positive integers. The following statement conjectured by Gauss and others, and later proved by Hadamard and by Charles- Jean dela Vallee Poussin is known as the prime number theorem. If $p(x)$ is the number of primes not exceeding x , then

$$\lim_{x \rightarrow \infty} \frac{\pi(x)}{x/\log x} = 1$$

of space. **Riemann**, one of the deepest mathematical thinkers of the century, generalized Gauss's differential geometry to a space of arbitrary number of dimensions. Half a century later, Riemannian geometry was the frame-work employed by **Albert Einstein** for formulating the general theory of relativity.

The rapid and unwieldy growth of mathematics prompted the beginning of the axiomatic movement in mathematics in the later part of the 19th century. Real analysis, that encompasses notions of limit, function, continuity, derivative, integral, infinite series and the myriad theorems that involve them, was put on a rigorous basis through the work of **Bernard Bolzano** (1781-1848), **Cauchy**, **Abel**, **Lejeune Dirichlet** (1805-59) and **Weierstrass**. The real number system itself, always taken for granted, came under close scrutiny. The understanding of rational and irrational numbers, algebraic and transcendental numbers, was improved. **Georg Cantor** founded the theory of sets and introduced fundamental notions concerning infinite sets. The study of sets of discontinuities of functions led to the notion of measure and eventually to a generalization of the notion of integral by **Henri Lebesgue** (1875-1941). The theory of integral equations was developed through the work of **Vito Volterra** (1860-1940), **Erik Fredholm** (1866-1927), **Hilbert** and **Erhard Schmidt** (1876-1959). The notion of function was generalized to a functional leading to an important branch of mathematics: functional analysis that has great contemporary significance. The study of invariants in differential geometry gave rise to Tensor Analysis. The beginning of Topology arose from the realization that certain properties of figures such as connectedness or lack of it are more primitive than their metric properties. Topology was to be a major force in 20th century mathematics.

Fig. 9.5: **Morley's Theorem:** In 1904, **F. Morley** discovered the theorem that if the angle trisectors are drawn at each vertex of a triangle, adjacent trisectors meet at the vertices of an equilateral triangle.

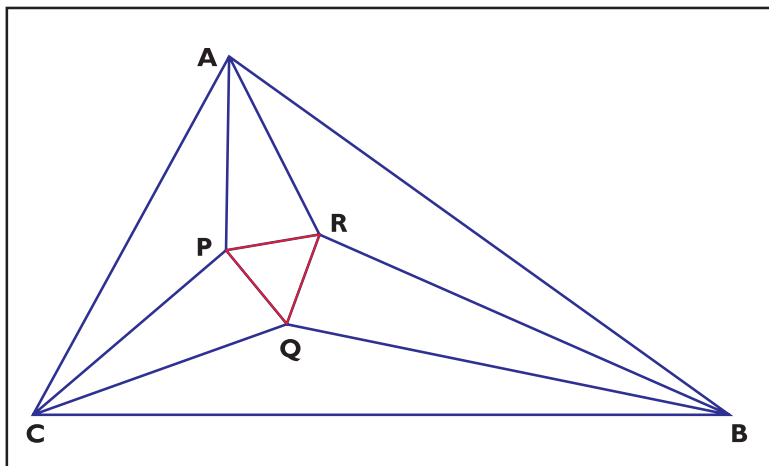
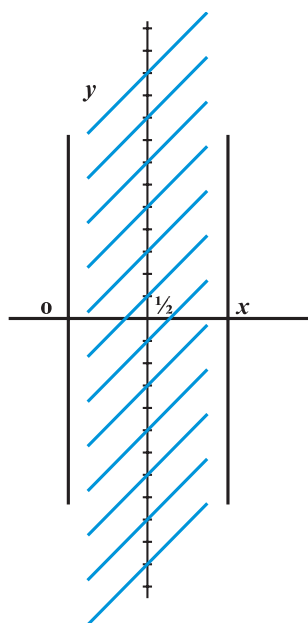

Fig. 9.3: **Sir William Rowan Hamilton** (1805-1865) invented the algebra of matrices which played an important role in Hamilton's mathematical treatment of optics and mechanics and also in quantum mechanics.

Fig. 9.4: **Karl Weierstrass** (1815-1897) had set the standard for rigour and precision in mathematical reasoning. His areas of work include number theory, complex variables, real analysis, symbolic logic and foundation of mathematics. He was a purist who pursued mathematics for its own sake.





Riemann hypothesis:
 Riemann zeta function $\zeta(s)$ is defined as:
 $\zeta(s) = 1 + 1/2^s + 1/3^s + \dots$
 If $s = x + iy$, all the zeros of $\zeta(s)$ in the strip
 $0 \leq x \leq 1$
 lie on the line $x = 1/2$.
 This is the famous Riemann hypothesis that remains unproven so far. Riemann introduced this function in connection with his work on the prime number theorem.

Fig: 9.6: Bernhard Riemann (1826-66)

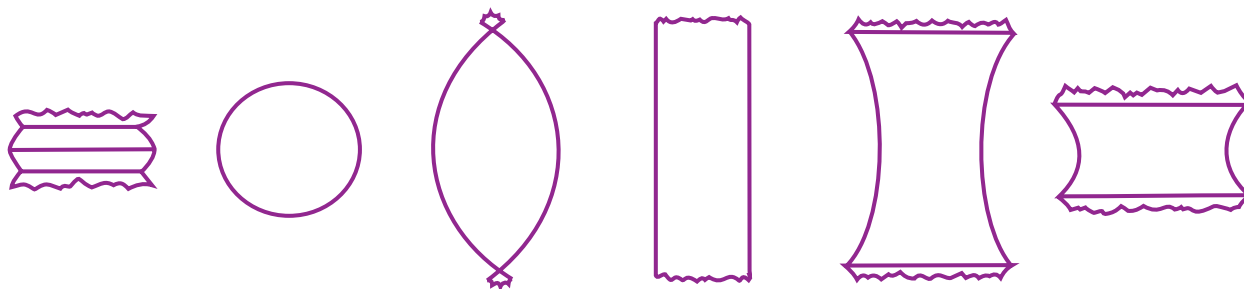

Fig: 9.7: In a Riemannian Geometry the first three objects have positive curvature, the fourth has a zero curvature and fifth and sixth have negative curvature.

Mathematics since Plato has been concerned with abstractions. Yet until the last century, the abstract objects of mathematics derived in some way from the real world. 19th century mathematics radically transformed this conception of mathematics. The creation of Non-Euclidean geometry, as also the introduction of different algebraic systems (e.g. Hamilton's quaternions, vectors, matrices) gradually led to the view that mathematics was man-made, a study of structures with arbitrary (but internally consistent) rules. This realization engendered one of the most fertile fields of modern mathematics: *abstract algebra* that deals with different systems: groups, fields, rings, non-associative algebra, etc, each with its own well-defined axioms.

The paradoxes of set theory triggered deep questions on the foundations of mathematics and its relationship to logic. The logicist school led by **Gottlob Frege** (1848-1925) attempted to build mathematics on logic, a programme pursued also by **Bertrand Russell** (1872-1970) and **Alfred Whitehead** (1861-1947) in their '*Principles of Mathematics*'. The intuitionist school founded by **Luitzen Brouwer** (1881-1966) challenged the role of logic and believed that mathematical ideas arise prior to language, logic and experience. The formalist school led by **Hilbert** sought to demonstrate the consistency of formal systems but met an anticlimax: **Kurt Godel's** (1906-78) incompleteness theorem which stated that any system embracing logic and number theory must contain an undecidable proposition.

A number that is a root of :

$$a_0x^n + a_1x^{n-1} + \dots + a_n = 0 ; a_0 \neq 0$$

where a_i 's are integers, is called an algebraic number of degree n . A number that does not satisfy any polynomial equation is called a transcendental number. π and e are examples of transcendental numbers. Introducing new algebraical structural notions of fields, rings and ideals, Dedekind founded the Algebraic number theory, which in this century has come to occupy a position intermediate between number theory and abstract algebra.



Fig: 9.8: Richard Dedekind (1831-1916)



Fig: 9.10: **Cantor's set - a Fractal:** Take a line segment. Divide it into three parts and remove the middle part. Divide each of the two remaining parts into three sub-parts and remove the middle sub-part. Iterate the process ad infinitum. The resulting set of points on the original line segment is called Cantor's set.



Fig: 9.9: **Georg Cantor (1845-1918):** One of the giants of mathematics in the later part of the last century, Cantor made fundamental contributions to the theory of infinite sets. He introduced the notion of cardinality: two sets have the same number of elements - the same cardinality - if the elements in the two sets can be matched one for one.



Fig: 9.11: The most generic topological surfaces from which many every day objects can be obtained by transformations. Topology is based on the notions of continuity and connectedness which are more primitive than the notion of distance (metric). It is concerned not with sizes and detailed shapes of geometrical objects, but whether they have knots or holes, etc. For topology, a sphere is equivalent to a cube but not to a torus.



Fig: 9.12: **Sofya Kovalevskaya (1850-91)**, born in Moscow, was a talented mathematician famous for her unique solutions to difficult problems such as the problem of rotation of a rigid body, the existence theorem for a set of partial differential equations, etc. She won the prestigious *Prix Bordin* of the *Academie des Sciences* in 1886.

20th century mathematics is so gigantic an enterprise that no single individual can hope to master even a small fraction of it. **Henri Poincare** (1854-1912), the great French mathematician, who made immense contributions to several areas of mathematics is said to be the last man who had working knowledge of nearly all of the mathematics of his time. Pure mathematics now is a completely autonomous activity with not even a semblance of connection with the applied. Yet astonishingly, time and again, products of pure mathematics are found to be of decisive use to science. As the scientist, **Eugene Wigner** (1902-95) put it: mathematics is unreasonably effective in describing nature.. Nobody really knows why.



Fig: 9.13: **Henri Poincare (1854-1912)**, was a distinguished mathematician and a theoretical physicist who also wrote on philosophy of mathematics and science. Besides his pioneering work in mathematics, he contributed to celestial mechanics, fluid mechanics, and the special theory of relativity.



Fig: 9.14: **David Hilbert (1862-1943)**: A German mathematician who worked on foundations of geometry. The famous 'Hilbert space' was the basis of the mathematical structure of quantum mechanics. Hilbert is also known for subjecting the axioms of Euclidean geometry to serious scrutiny. He applied the calculus of variations to the general theory of relativity enabling the derivation of Einstein's field equations from a generalised principle of least action.

A definitive generalization of the notion of integral was developed by Lebesgue. Consider the highly discontinuous function $f(x)$ defined over the interval $0 \leq x \leq 1$ as:

$$f(x) = \begin{cases} 1 & \text{if } x \text{ is a rational number} \\ 0 & \text{if } x \text{ is an irrational number.} \end{cases}$$

The integral of this function over the interval $[0,1]$ is not defined in the conventional (Riemann) sense. Its Lebesgue integral, however, is well-defined and equals zero.



Fig: 9.16: **Srinivasa Ramanujan (1887-1920)**: An Indian mathematician with deep mathematical intuitions, who churned out about 4000 original theorems in mathematics. A child prodigy, Ramanujan was one of India's greatest mathematical geniuses. He made substantial contributions to number theory and worked on elliptic functions, continued fractions and infinite series. The International Journal, *The Ramanujan Journal*, is devoted to the areas of mathematics influenced by Ramanujan.



Fig: 9.15: "The question of the ultimate foundations and the ultimate meaning of mathematics remains open; we do not know in what direction it will find its final solution or even whether a final objective answer can be expected at all. 'Mathematizing' may well be a creative activity of man, like language or music, of primary originality, whose historical decisions defy complete objective rationalization." **Herman Weyl (1885-1955)**



Fig: 9.17: **Kurt Godel (1906-1978)** is well-known for his work on Foundations of Mathematics.

10

Growth of Biological thought

Natural History



Fig: 10.1: **John Ray (1627-1705)** formalized the concept of species, as “a collection of individual animals or plants that reproduced among them”. In his book *The Wisdom of God* (1691), however, he says that the immutable species is the creation of God. William Paley in his *Natural Theology* popularized this argument.

Before modern biology took shape as a distinct discipline in the twentieth century, fundamental contributions to biological thought began to emerge sporadically and slowly from about sixteenth century onward. Some of the significant discoveries are: **Vesalius’s** detailed pictorial description of human anatomy, **Harvey’s** discovery of the mechanism of blood circulation, **Hooke** and **Leeuwenhoek’s** observations of cells and microbes, and **Redi** and **Spallanzani’s** demonstration that maggots do not arise spontaneously from meat and organic matter. None of these discoveries, however, could develop as unifying theories in biology.

The character of biology changed gradually with contributions from **Carolus Linnaeus** (1707-78), **Baron Cuvier** (1769-1832), **Jean Baptiste de Lamarck** (1744-1829) and others. Linnaeus, a Swedish natural historian, developed an artificial system of hierarchical classification based on the floral characters of plants. He also developed an elaborate terminology of plant morphology including a popular method of naming organisms: binomial nomenclature. Cuvier studied the anatomical features of a range of organisms pointing out the underlying architecture and how the organs get

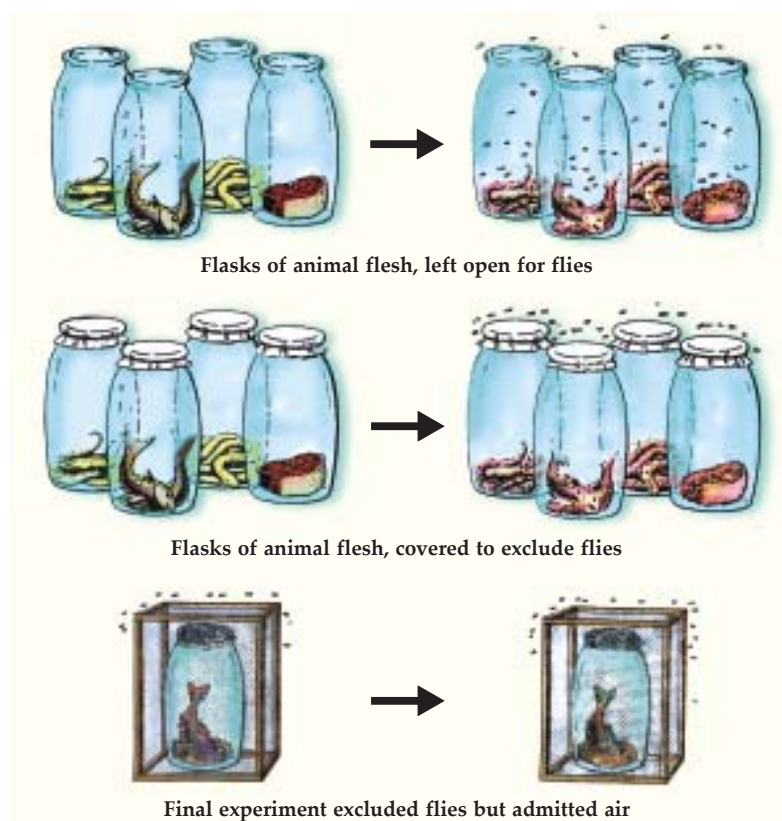

Fig: 10.2: **Redi’s experiment: Francesco Redi (1626-1697)** demonstrated that maggots do not appear spontaneously in meat, but they develop from eggs laid by flies. **Lazarro Spallanzani (1729-1799)** disproved the theory of spontaneous generation in a similar fashion.

together to form a “unique and perfectly integrated whole.” He used this knowledge to reconstruct the entire organism from the features of a single fossil bone. Species, a collection of individuals that can reproduce among themselves, was believed to be immutable by most naturalists of this period, including Linnaeus and Cuvier.

Palaeontology

Biblical sources mention the age of the earth as 6000 years, and the state of the earth is explained to be a result of catastrophic events like the Biblical Flood. **James Hutton** (1726-97) contested this view by suggesting a very long history to the earth on the basis of uniformitarianism. According to this view the geological processes (erosion, transportation, deposition, sedimentation and volcanism) occur in a cyclical manner and with the same intensity. Eventually **William Smith** (1769-1839) discovered a remarkable progression from the simple to the complex fossil forms in the strata of the sedimentary rocks. He used this discovery in the construction of geological maps. The studies of **Charles Lyell** (1797-1875) refined uniformitarianism and established geology as a science. These discoveries played a crucial role in the development of the theory of organic evolution.



Fig: 10.3: Comte de Buffon's (1707-1788) interests shifted from physics and mathematics to natural history. His forty four volume *Histoire Naturelle* was extremely popular and caught the attention of many intellectuals. He proposed the 'natural system' of classification. Unlike Linnaeus, Cuvier and many of his other contemporaries, he emphasized mutability and the continuity of species, and believed that the earth must be much older than 6000 years.

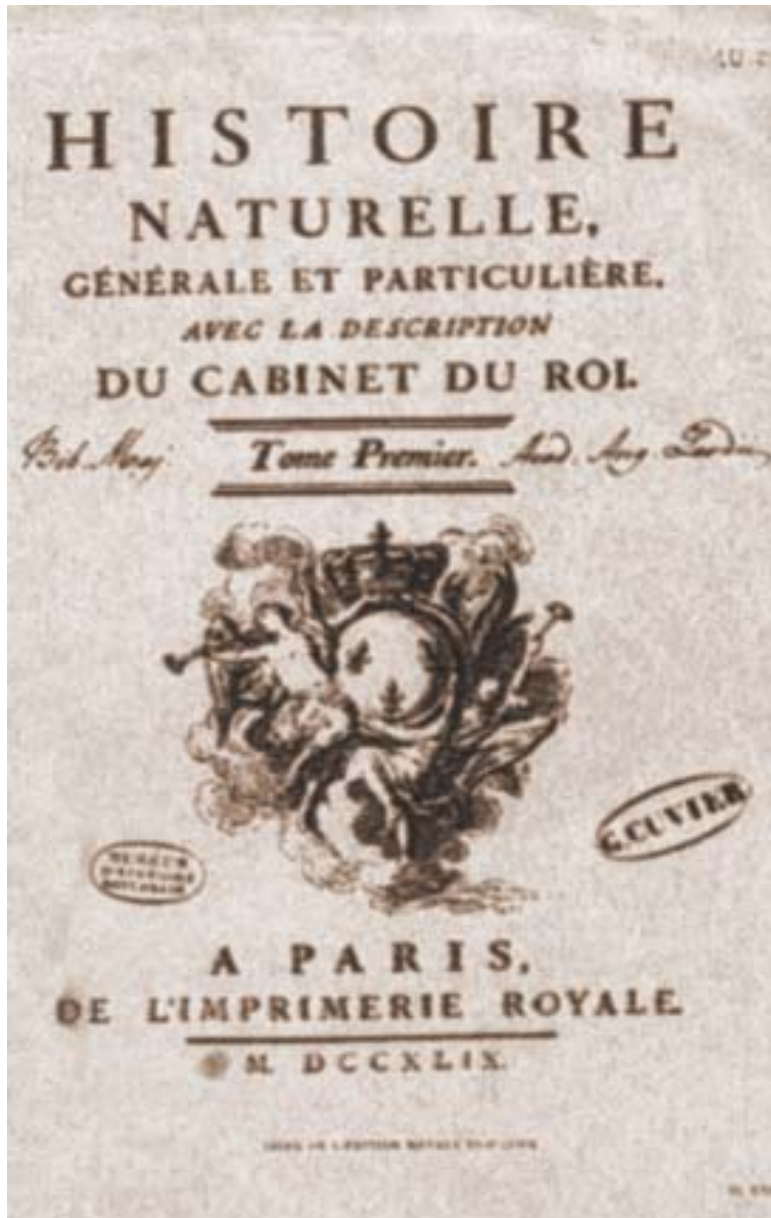

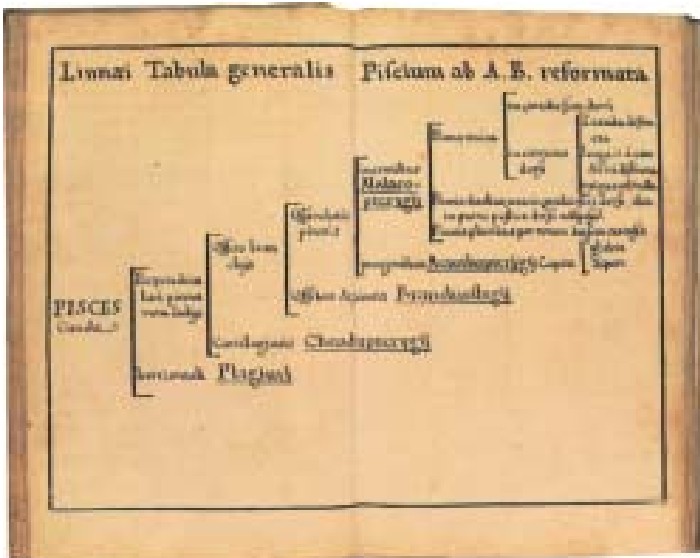

Fig: 10.4: Carolus Linnaeus (Carl von Linné) (1707-1778) well known for his contributions to plant taxonomy also made important contributions to biogeography and ecology. He was a Professor of Medicine and later occupied the Chair of Botany at Uppsala University.



Fig: 10.5: Abraham Gottlob Werner (1750-1817), a German mining teacher, investigated rocks and minerals and was the first to classify them systematically.



Fig: 10.6: James Hutton (1726-1797) believed that the earth must have witnessed a past of immense duration. His *Theory of Earth* (1788) ends: "...we find no vestige of beginning, no prospect of an end."

Fig: 10.7:

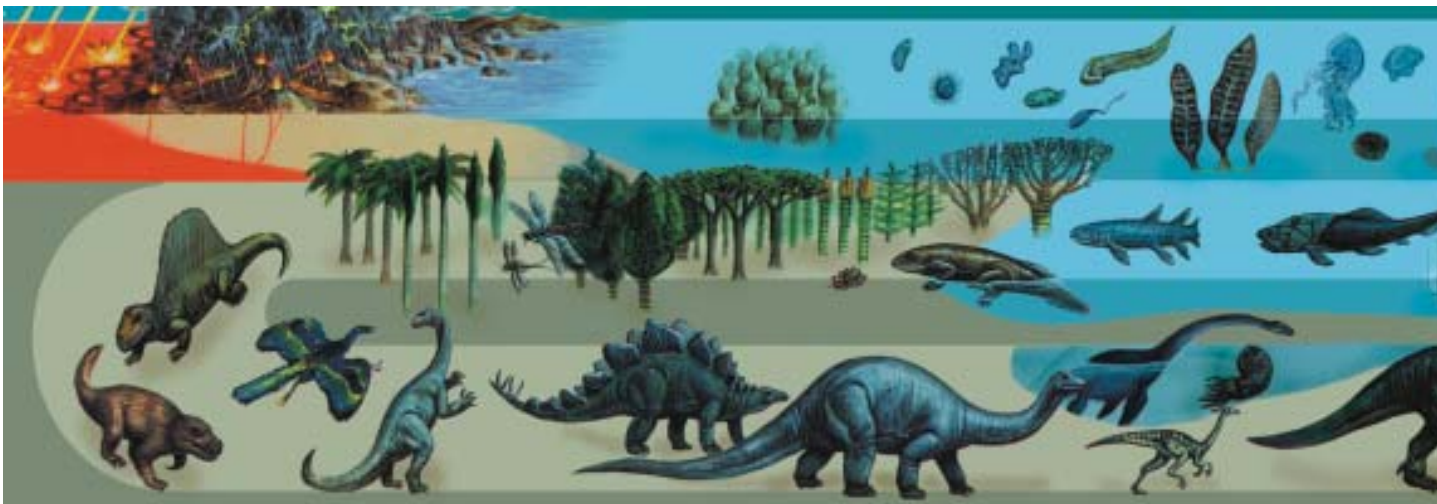



Fig: 10.8: The arrangement of fossils in the stratified rocks indicated the order of the geological time scale and helped in ascertaining the age of the earth. The arrangement of fossils in the stratified rocks indicated the order of the geological time scale and helped in ascertaining the age of the earth.

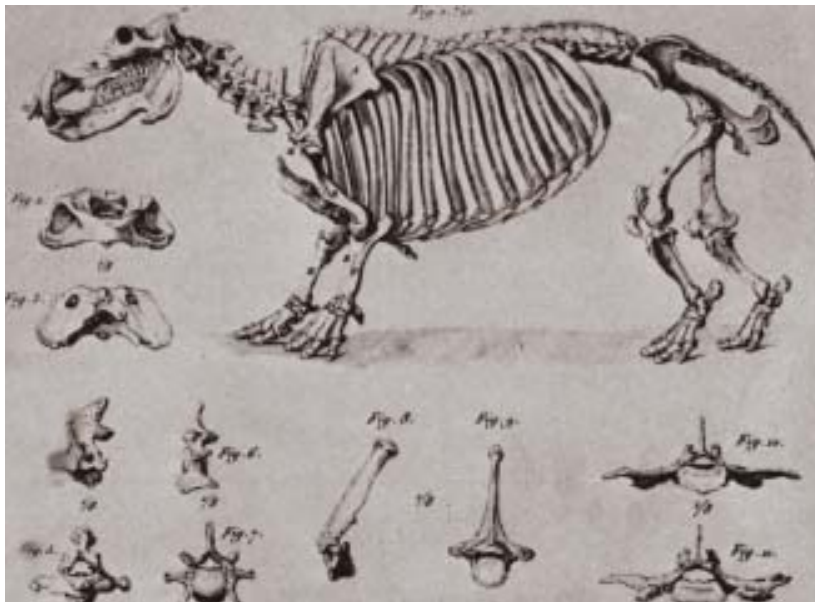

Fig: 10.9: **Baron Cuvier (1769-1832)** was a highly respected figure in French society and science. He was Professor of Anatomy at *Muse'um d'Histoire Naturelle* in Paris. He studied many fossils as also the geological history of the stratified sedimentary rocks of the Paris basin, and established the thesis that some species had become extinct.





Fig: 10.10: **William Smith (1769-1839)** studied fossils covering most of England and Wales, and published a geological map. This was a great contribution to the establishment of a geological timescale.

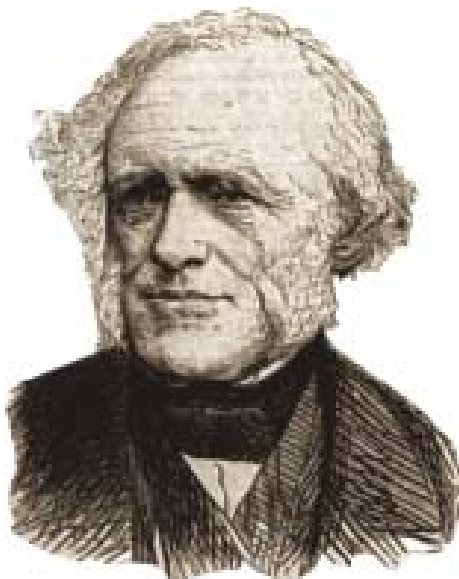

Fig: 10.11: **Sir Charles Lyell (1797-1875)** was a Professor of Geology, at King's College, London. His three volume book *Principles of Geology* (1830-1833) provided major inputs for Darwin's theory of evolution.

Evolution, Microbiology and Cell Theory

Jean Baptiste Lamarck (1744-1829) studied variations in invertebrate fossils and proposed the first organic theory of evolution. The theory proposes that organisms have an innate potential to become progressively complex in an ever changing environment, so as to achieve a harmonious balance between the environment and the organisms. The idea of evolution, however, was not widely accepted till **Charles Darwin (1809-82)** and **Alfred Wallace (1823-1913)** independently proposed the theory of natural selection as a mechanism of evolution. The idea of evolution not only provided a unifying framework for biology, but also had far reaching religious, philosophical, ideological and social implications. The thought that living organisms had evolved by natural processes without the necessity of divine intervention, deprived human beings of their special status and placed humanity on the same plane as animals.

In the mid-19th century, additional inputs for studying life processes came from microorganisms, ignored for nearly 100 years despite their discovery by **Marcello Malpighi (1628-94)** and **Antony van Leeuwenhoek (1632-1723)**. The simple and elegant experiment of **Louis Pasteur (1822-95)** conclusively disproved the idea of spontaneous generation. He established the role of microbes in fermentation and breweries, and by developing the rabies vaccine laid the scientific basis of vaccination. Around 1880, **Robert Koch (1843-1910)** established the bacterial origin of several diseases, and postulated guidelines to identify the causative agents of infectious diseases.

Parallel to the developments in the natural history stream, the anatomical study revealed the organization of different organs and tissues of plants and animals, eventually leading to the recognition that the cell is the structural and functional unit of all organisms. This is the essence of the cell theory published in 1839 by **Theodor Schwann** and **Mathias Schleiden**. **Rudolf Virchow's** proclamation in 1855 that "every cell originated (by cell division) from a preexisting cell" gave a further death-blow to the ideas of vitalism and spontaneous generation.



Fig: 10.12: **Antony van Leeuwenhoek**: The single lens microscopes made by Leeuwenhoek helped discover the world of microbes. With his microscopes, capable of magnification up to 270 times, he described a variety of micro-organisms, including protozoans, single celled algae, bacteria, rotifers and others.

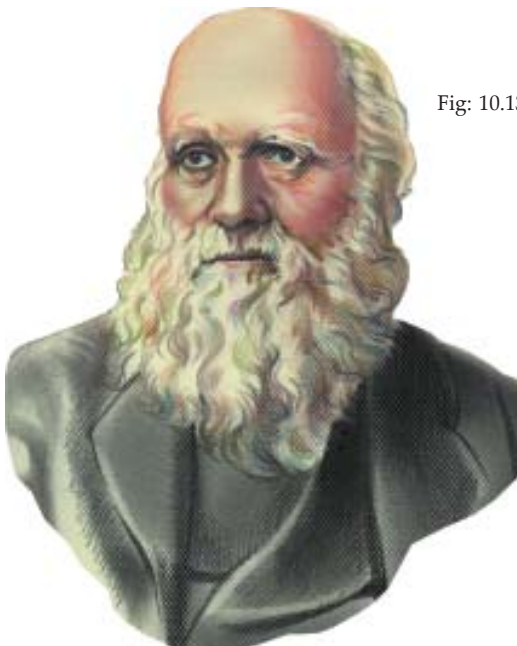

Fig: 10.13: **Charles Darwin**



Fig: 10.15: **Alfred Wallace** after leaving grammar school at the age of 13, served as a surveyor and collected birds and insects. He independently reached the same conclusion as did Darwin. He announced his theory of evolution in a paper published in 1855. The work of Darwin and Wallace was presented to the Linnean Society of London on July 1, 1858. He also wrote a pioneering book on zoogeography titled *Geographical Distribution of Animals* (1876).

Fig: 10.14: The route of the ship H.M.S. Beagle





Fig: 10.16: Darwin with a prepared mind worked for endless hours on the ship *H.M.S. Beagle*, collecting, observing, reading and methodologically interpreting his observations. Explaining the diversity of species was the fundamental problem for Darwin. His thoughts culminated in the book *On the Origin of Species* (1859), which explains organic diversity and the origin of new species from old ones by the process of 'natural selection' and 'common descent.'

Fig: 10.17: Variation in the shape of beaks of finches found on the Galapagos islands by Charles Darwin was a key observation that led to the formulation of his theory of evolution.



Fig: 10.21: **Edward Jenner (1749-1823)** inoculated (vaccinated) James Phipps on 14th May 1796, with germs causing cowpox which protected the boy from smallpox disease.

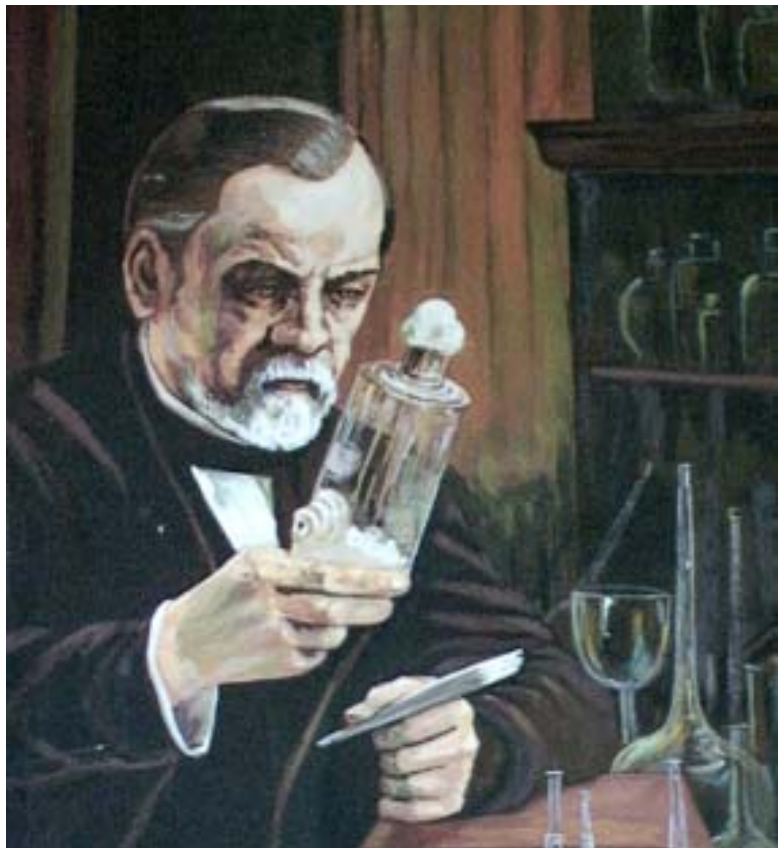

Fig: 10.22: **Louis Pasteur (1822-1895)** conclusively disproved the theory of spontaneous generation, and proved that the growth of 'microscopic beings' in a nutrient medium is not spontaneous. Germs floating in the air contaminate the nutrient medium, and by preventing this contamination, he checked the growth of microbes.

Fig: 10.23: An illustration of Haeckel's famous dictum: 'Ontogeny recapitulates phylogeny'.



Birth and Development of Genetics

Why do offsprings resemble their parents? This was a question that attracted several speculations, but none could provide an experimental method to investigate the phenomenon till **Gregor Mendel** showed the way. Mendel stated the law of inheritance in 1866, based on a remarkable analysis of statistical data from the hybridisation experiments with garden pea plants. He hypothesised that the factors of inheritance are discrete and they segregate during the gamete formation, thus foreseeing the process of meiosis. In 1900, three scientists independently rediscovered Mendel's laws on the basis of breeding experiments on plants. **Edmund B. Wilson** (1836-1939), **Theodor Boveri** (1862-1915) and **Walter Stanborough Sutton** (1877-1916) studied cell division in animal cells during 1900-03, and hypothesised that chromosomes are the physical basis of inheritance by relating the behaviour of chromosomes during meiosis to Mendelian factors.

Biologists attempted to extend the Mendelian experimental methods to animals. **Thomas Morgan's** laboratory in America introduced and conducted experiments with *Drosophila* (fruit fly). His laboratory, which included brilliant scientists like **A. H. Sturtevant** and **C. B. Bridges**, made phenomenal contributions to genetics. Their first discovery that certain characters are invariably linked to female flies corrected Mendel's law of independent assortment. Further investigations by Sturtevant on linkage patterns of several characters developed into a sophisticated field of recombination genetics and gene mapping. Soon Bridges discovered a correlation between the pattern of linkage and the number of chromosomes in a cell, proving Sutton's hypothesis that hereditary factors (genes) are located on chromosomes. This led to the birth of cytogenetics. **Barbara McClintock's** extensive work on the breeding patterns of maize showed that genes can not only be rearranged on a chromosome, but can also be moved within a set of chromosomes.



Fig: 10.24: **Robert Koch** (1843-1910) established the bacterial origin of many infectious diseases. The methods of microbiology developed by Koch and his students were essential for the growth of this budding science of the time.

Fig: 10.25: **Gregor Mendel** (1822- 1884), an Austrian monk, whose experiments in his garden led to the discovery of the laws of heredity.





Fig: 10.26: **Hugo de Vries (1848-1935)** rediscovered Mendel's laws in 1900. While experimenting with the evening primrose (shown in the picture) he discovered the occurrence of mutations.



Fig: 10.27: **Charles Sherrington (1857-1952)** realised the complexity of the nervous system and established a 'grammar' of nervous action.

Fig: 10.28: **Claude Bernard (1813-1878)** is considered the founding father of experimental physiology. He introduced the concept of self-regulation which is a living organism's ability to maintain the stability of its internal environment.



Fig: 10.29: **Thomas Hunt Morgan (1866-1945)** and his students' experiments with *Drosophila melanogaster* established the framework for the development of modern genetics.





Fig: 10.30: Santiago Ramón y Cajal

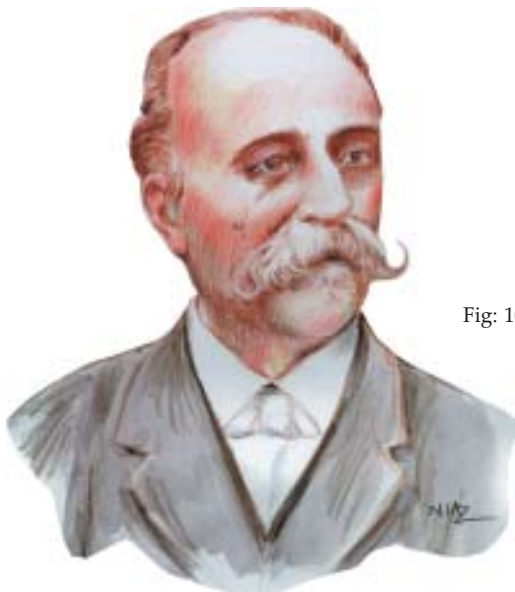

Fig: 10.31: Camillo Golgi

Fig: 10.32: Camillo Golgi (1843-1926) and Santiago Ramón y Cajal (1852-1934) shared the 1906 Nobel Prize in Physiology and Medicine for their outstanding work in cytology and histology. Golgi put forth the theory that there are two types of nerve cells (sensory and motor) and that axons are concerned with the transmission of nerve impulses.

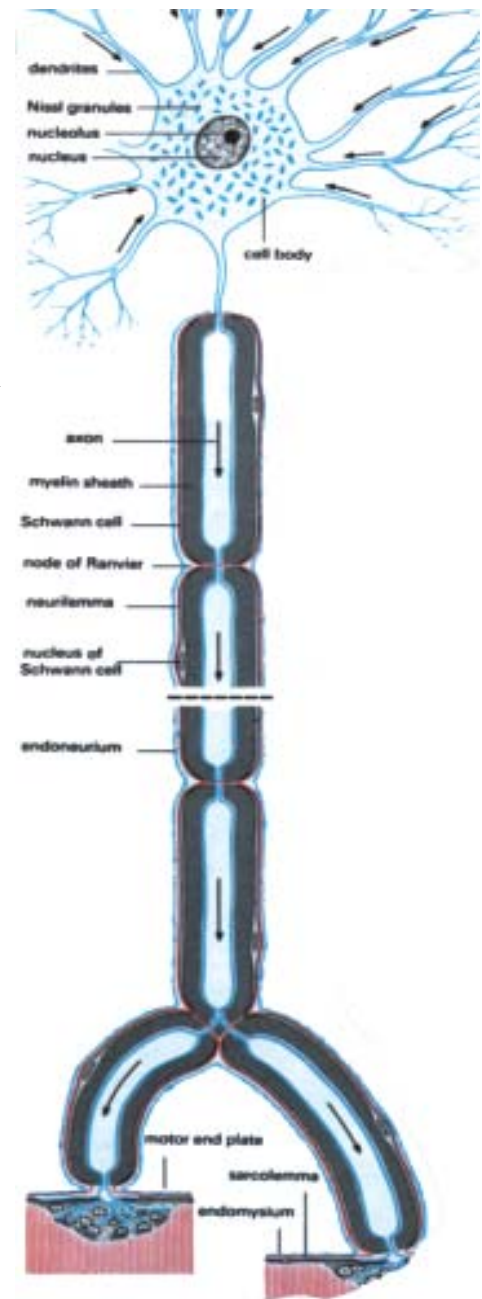
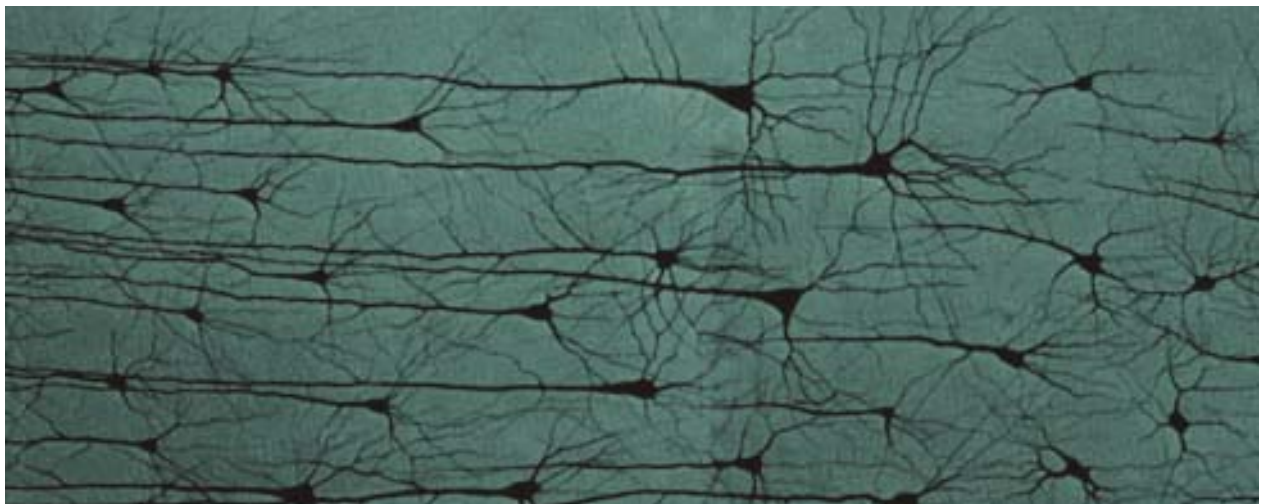

Fig: 10.34: A Golgi-stained section of human brain tissue



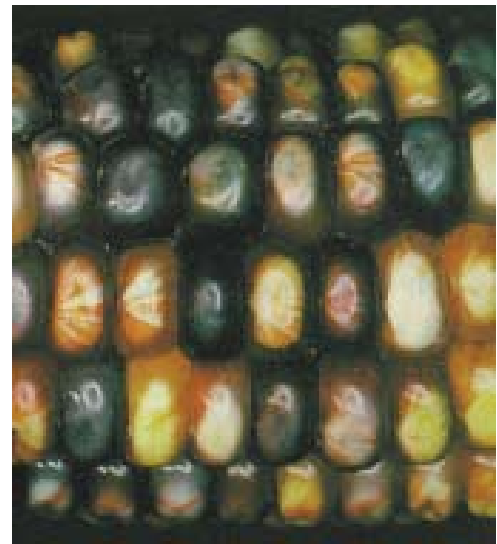

Fig: 10.35: **Barbara McClintock (1902-1992)** received the Nobel prize in 1983 for her discovery of 'jumping genes' (1951) in maize. She was the president of the Genetics Society of America in 1945, the third woman to be elected member of the National Academy of Sciences.

Fig: 10.36: **Alexander Fleming (1881-1955)** in 1928 discovered that the mould *Penicillium notatum* produces antibacterial substance (antibiotic) penicillin.



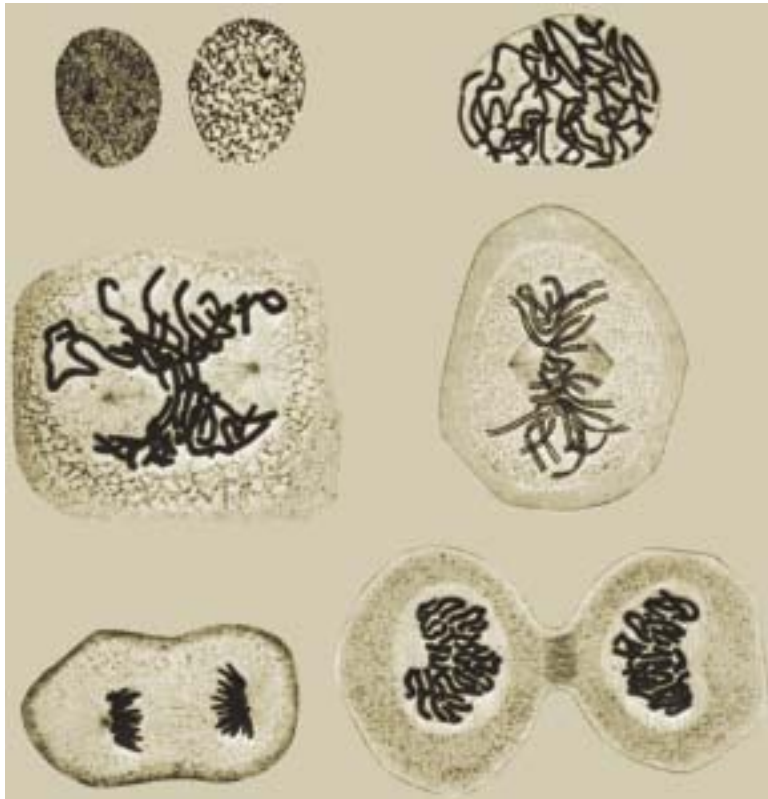

Fig: 10.37: **Walther Flemming's 1882 illustration of mitosis in fixed and stained cells of a salamander embryo:** Friedrich Anton Schneider and Walther Flemming (1843-1905) studied and described the process of cell division.

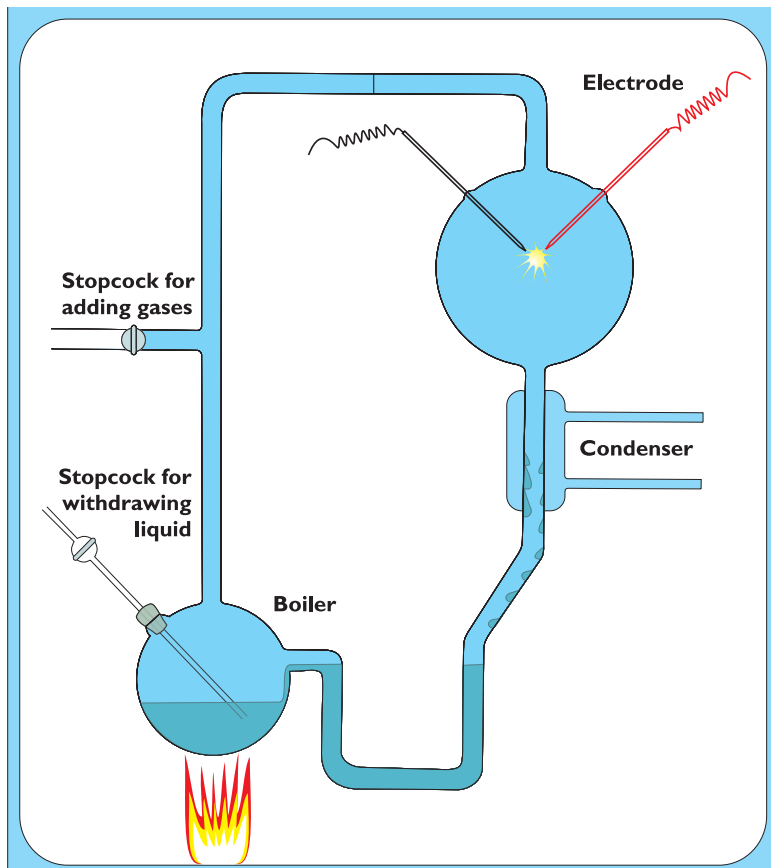
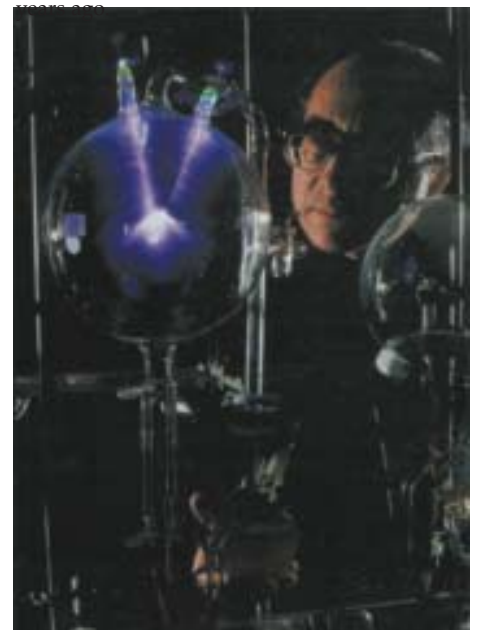

Fig: 10.38: **Stanley Miller's experiments** produced many complex organic molecules important for 'life' by passing an electric discharge through a mixture of gases like those found in primeval atmosphere. His experimental setup mimics the atmospheric conditions which might have existed on the earth some four billion



Astronomy

Newton's *Principia* closed a period in astronomy that began with Copernicus and Kepler. The correct prediction of the return of 'Halley's Comet' in 1758 triumphantly vindicated the work of that period. The most notable astronomer of the late eighteenth century, William Herschel, painstakingly catalogued the heavens and also discovered the planet Uranus. Much later, from the observed discrepancy in the motion of Uranus, astronomers inferred and then verified the existence of another planet: Neptune. The last planet discovered was Pluto (1930).

In the nineteenth century, telescopes of large apertures began to be built. These in conjunction with photography recorded fields of stars for precise measurements. The parallax method was used to estimate distances of nearby stars. Stellar spectra emerged as an important area of study. A new element (helium) was discovered from the solar spectrum, and later isolated in the laboratory.

Fig: 11.1: **Charles Messier (1730-1817)**: French observational astronomer, made a list of all the blur objects in the sky and published in 1784 a catalogue containing 100 objects, known as Messier catalogue. The engraving by Messier shows the two possible orbits of the return of the comet.

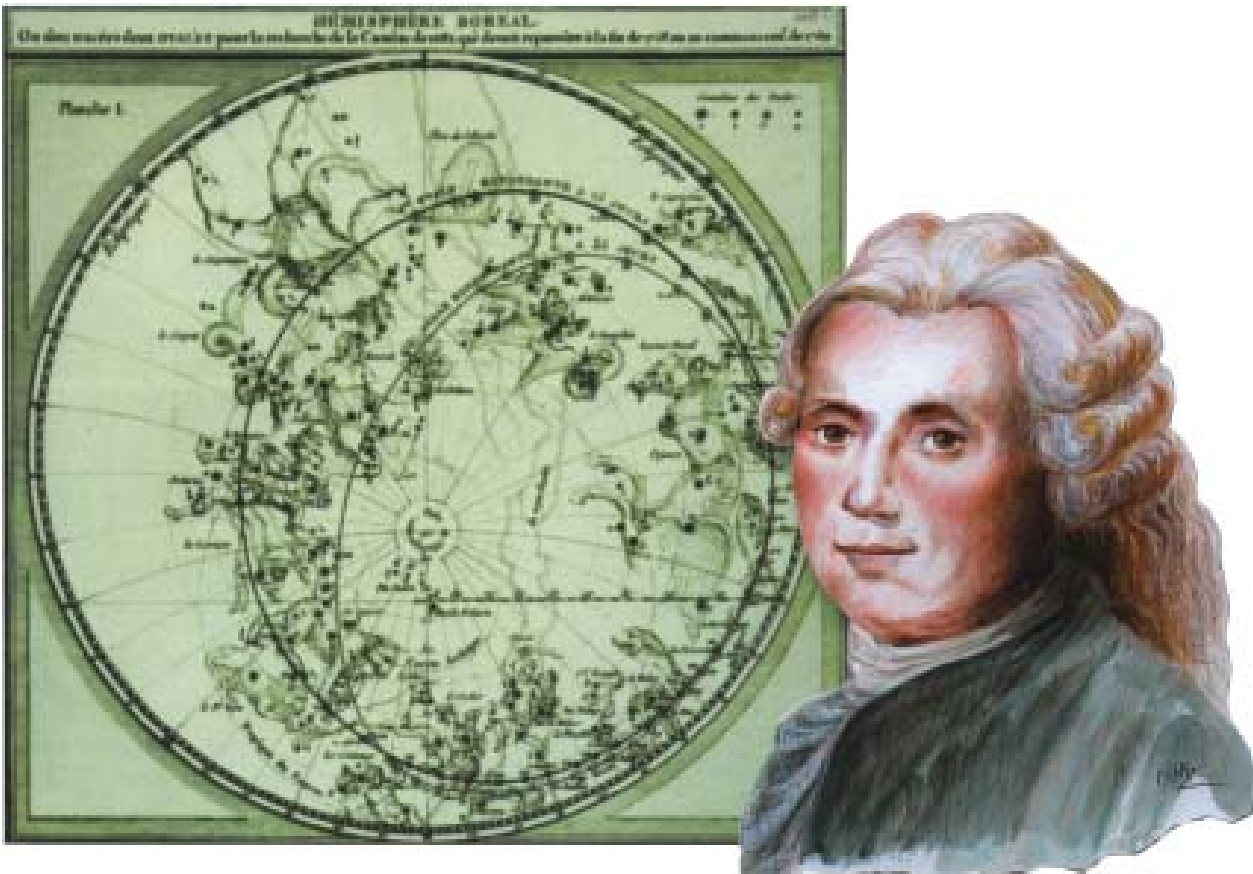



Fig: 11.2: **Herschel's telescope:** Musician by day and an astronomer by night, Herschel was also a mirror maker. He personally ground and polished the mirrors for his telescopes. The picture shows Herschel's giant reflector which he built in 1780s, with an aperture of 1.2 m and a focal length of not less than 12 m.



Fig: 11.3: **William Herschel (1738-1822)** was the British astronomer who discovered Uranus in 1781. He also catalogued more than 800 double stars and 2,500 nebulae.



Fig: 11.4: William Herschel determined the shape of the Milky Way by counting stars visible in different areas of the sky. The more concentrated the stars in a particular area, the further out the Milky Way must extend in that direction. Though the roughly flat system (shown in the picture) proved accurate, the jagged edge and centrally positioned sun did not.



Fig: 11.5: **Caroline Herschel (1750-1848)**, the sister of William Herschel, independently discovered eight comets and three nebulae. She published her *Catalogue of Stars* with the Royal Society. She was the first woman to publish scientific findings in the *Philosophical Transactions* of the Royal Society. She was awarded the Gold Medal of the Royal Astronomical Society and elected an honorary member in 1835 at the age of eighty five.



Fig: 11.6:

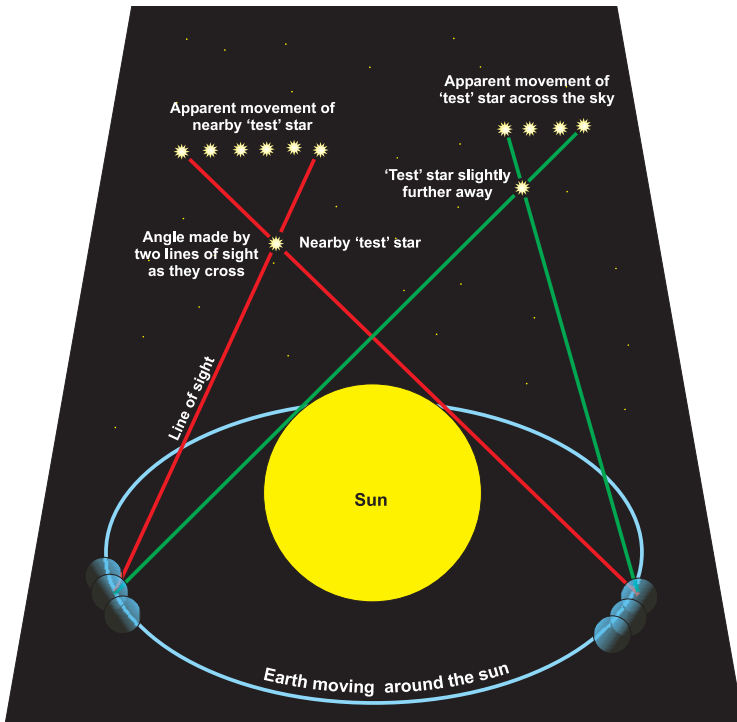

Fig: 11.7: Friedrich Wilhelm Bessel (1784-1846) extended the surveyors' method of calculating the distance of distant objects to stars in which the earth and sun constitute the base line.

Fig: 11.8: **A Comet in its orbit:** As a comet approaches the perihelion of its highly elliptical orbit, tails of dust and ionized gas begin to grow larger and larger. The straight tail away from the Sun is that of ionized gas while the tail of dust is curved. Cometary tails can be long enough to reach the earth or cross its orbit.



Fig: 11.9: The Great Red Spot and White Oval of the planet Jupiter, as seen by Voyager 1.



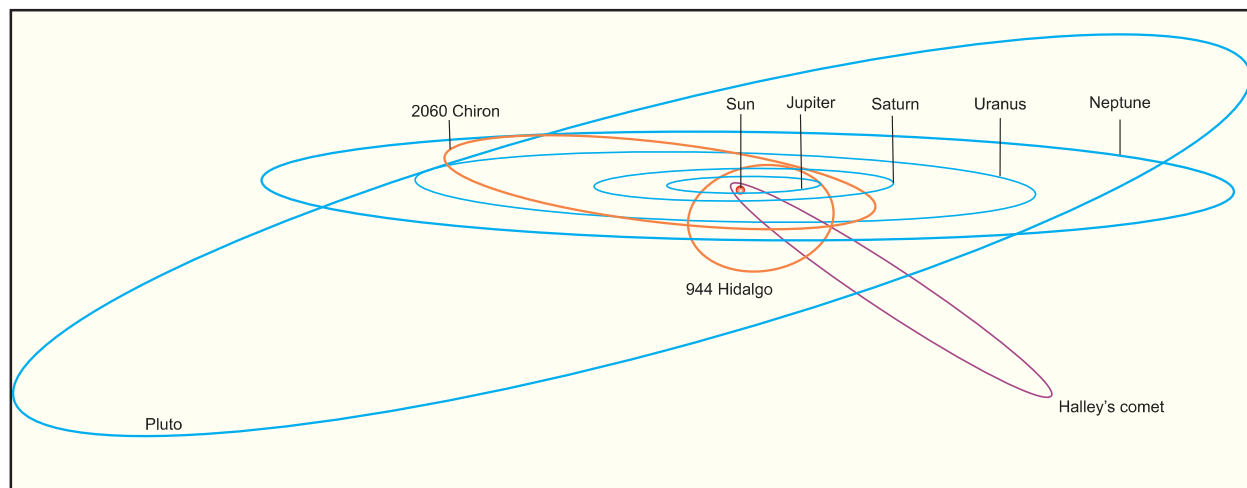

Fig: 11.10: **Discovery of the Planets of our Solar System:** We knew only six planets till Uranus was discovered by William and Caroline Herschel on 13 March 1781. The planet Neptune's existence was predicted by John Couch Adams in England and Urbain-Jean-Joseph Le Verrier in France. In 1846 Johann Galle found the planet at the predicted position. Pluto was discovered during a laborious search of the heavens. Two Bostonians, William Pickering and Percival Lowell, predicted the path of the missing ninth planet. It was on February 18, 1930 that Clyde Tombaugh finally discovered the planet which was named Pluto (first two initials after Pickering and Lowell). The picture shows the orbits of the planets, Halley's comet, and two minor planets (asteroids) Chiron and Hidalgo.

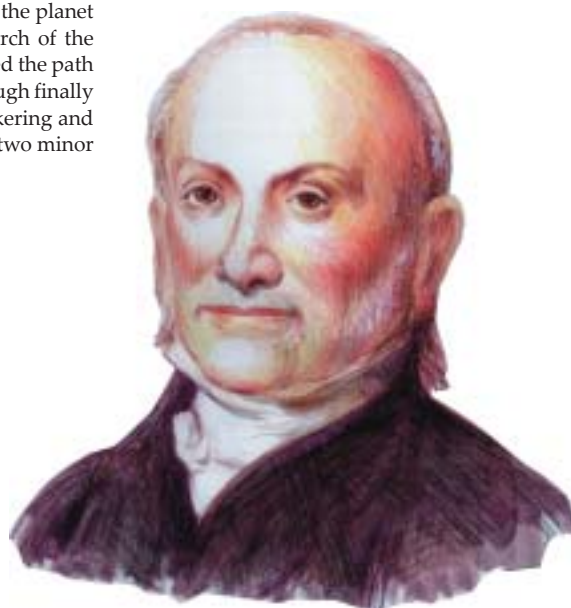

Fig: 11.11: John Couch Adams (1819-1892)



Fig: 11.12: Urbain Le Verrier (1811-1877)



Fig: 11.13: Clyde Tombaugh (1906-1997)

Fig: 11.14: **The first photograph of the Sun** obtained by direct impression, at 09.45 on 2nd April 1855 by Fizeau and Foucault.

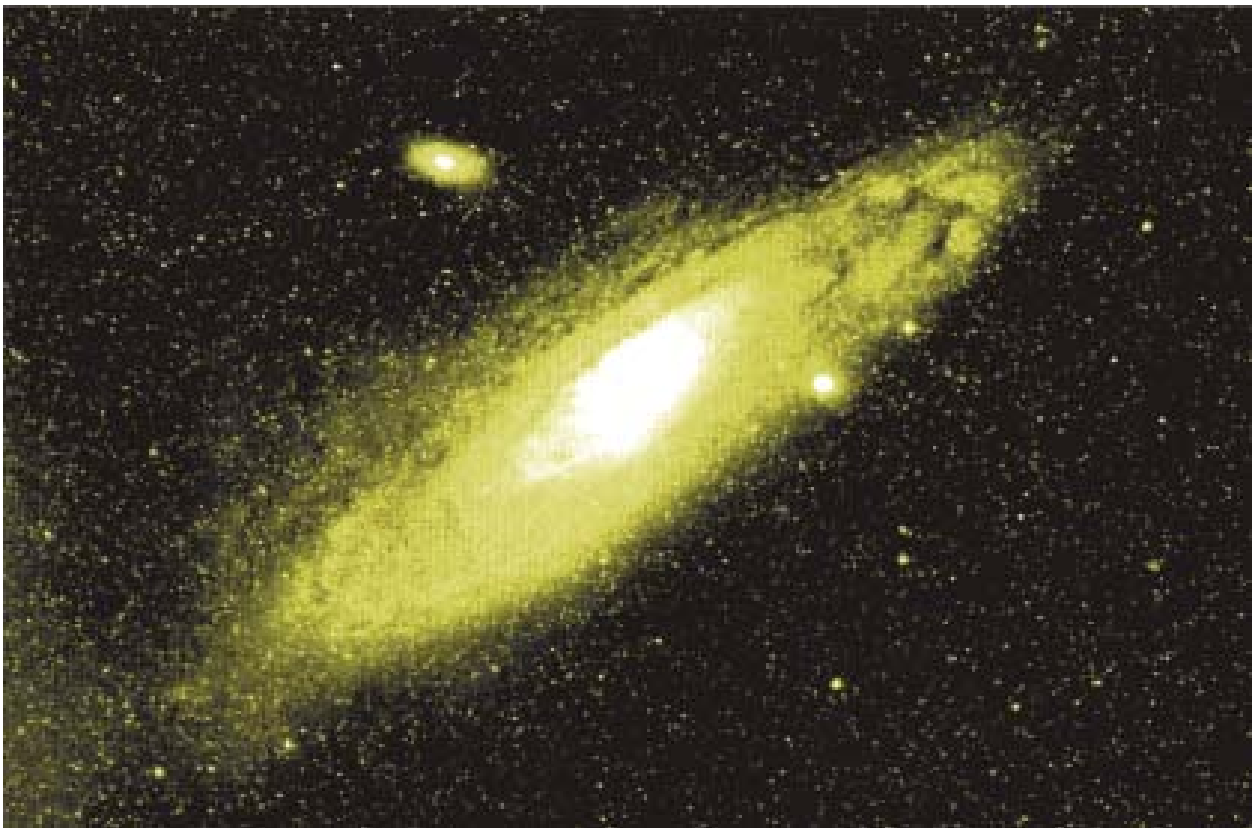
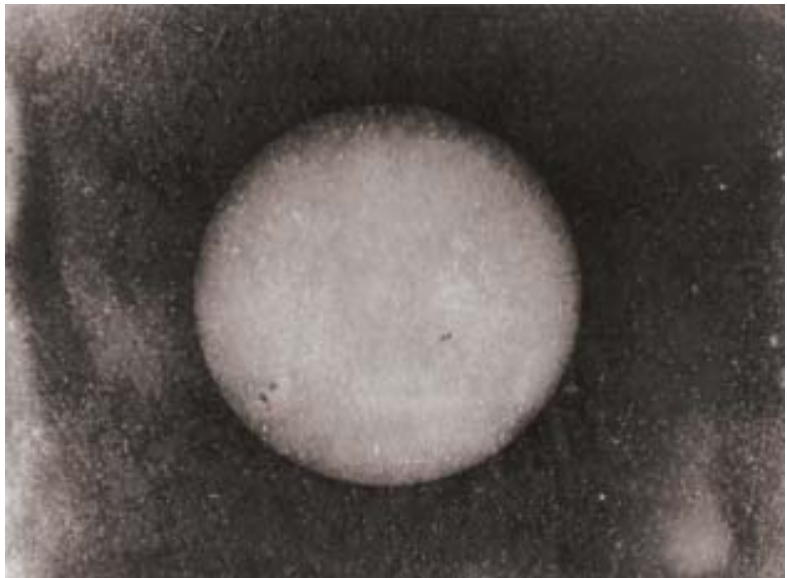

Fig: 11.15: **The Andromeda Galaxy:** This spiral galaxy about two million light years away has some seven closely wound spiral arms. With our own galaxy, the Milky Way, it belongs to the so called local group of galaxies. The two other bright spots seen in the photograph are its two satellite elliptical galaxies.

The 20th century was marked by vast improvement in telescope power. A 40-inch refractor was set up at the Yerkes Observatory near Chicago in 1897. Giant 100-inch and 200-inch reflecting telescopes were set up at Mount Wilson in California (1917) and at Palomar (1948). A new method using 'Cepheid Variables' was employed to determine stellar distances; the old estimates were revised. The universe was found to consist of myriads of galaxies like our own (The Milky Way). From observations on Doppler red shifts, Edwin Hubble made the key astronomical discovery of the century: the galaxies were receding from one another, with velocities greater for more distant galaxies, indicating that our universe is expanding. The century opened new windows of the electromagnetic spectrum for observing the universe. Radio

telescopes were built and special interferometric techniques developed to overcome the problem of low resolution due to the long wavelength involved. Radio astronomy scored two major successes in the 1960's: discovery of quasars (very distant but bright objects whose source of energy is still a mystery) and pulsars, now identified as super dense stars (neutron stars). Space exploration by unmanned and manned rockets and satellites became a reality. The first human footsteps on the lunar surface appeared in July 1969. Our knowledge of the planetary system improved vastly. Besides, the short ultraviolet, X-ray and Gamma-ray radiation from space which never reaches the earth's surface was studied from highflying rockets and satellites. Highly energetic explosive sources were detected, indicating the possibility of the existence of 'black holes'.

Spectroscopic study of the stars gave birth to the discipline of astrophysics that made great strides during this century. A relationship between intrinsic brightness and spectral class of a star obtained by **Ejnar Hertzsprung** (1873-1967) and **Henry Russell** (1877-1957) became a source of many productive ideas. Nuclear fusion was identified as the source of stellar furnace, and detailed chains of nucleosynthesis of different elements were worked out. Astrophysical theory made impressive advances in understanding stellar structure and evolution, and yielded insights on how the fate of a star (after its fuel burns out) is related to its mass.



Fig: 11.16: **Arthur Eddington (1882-1944)**, an eminent British scientist, led an expedition to observe the total solar eclipse of 1919 and measure the bending of light rays near the sun which was predicted by Einstein in his general theory of relativity. In 1914, he put forward the idea that nebulae were separate galaxies. He also established the link between the star's size and its brightness.

Fig: 11.17: **The Radio Telescope near Arecibo, Puerto Rico**: One of the biggest and most sensitive of its kind, this radio telescope located in a natural bowl in a mountain has a 300 m wide dish of wire netting. Radio waves emanating from the sky are reflected by the dish to an overhead aerial that is moved for focussing on different astronomical objects.





Fig: 11.18: Hubble used the 100-inch telescope (shown in the picture) on Mount Wilson in southern California.



Fig: 11.19: **Edwin Powell Hubble (1899-1953)**, an American astronomer, identified the individual stars in Andromeda galaxy and introduced the widely used system for classifying galaxies (spirals, barred spirals and ellipses). The Hubble's law - the farther the galaxy from the Earth, the faster it is moving away - has been a core argument for an expanding universe.

Fig: 11.20: **The White Dwarf:** Sirius, the brightest star in the sky to the naked eye, has a companion that is ten thousand times fainter. With a mass comparable to the mass of the Sun and size only five times the earth's size, this companion (the small spot to the right of Sirius in the photograph above) is a White dwarf - the ultimate fate of any star with mass less than the Chandrasekhar's Limit (about 1.4 solar mass).

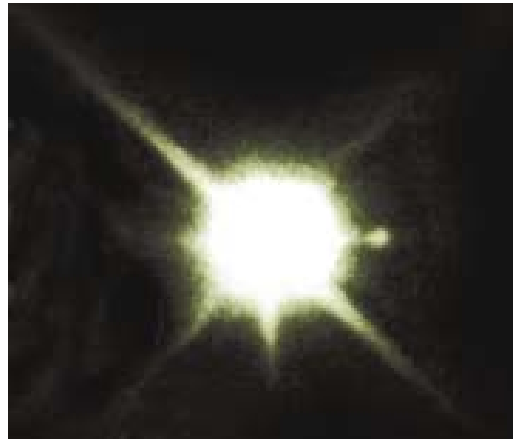

Fig: 11.21: **Subramanyam Chandrasekhar (1910-1995)** made a fundamental discovery in 1934: the Chandrasekhar Limit. This work describes what happens to a star when nuclear reactions in its interior come to a halt, and stars begin to collapse due to their own gravity. Stars with mass less than the Chandrasekhar Limit become white dwarfs. But more massive stars continue to collapse past the white dwarf stage till they become neutron stars or black holes depending on their mass. Time proved Chandrasekhar right. All the white dwarfs discovered lie neatly on the curve that Chandrasekhar had calculated from purely theoretical arguments.

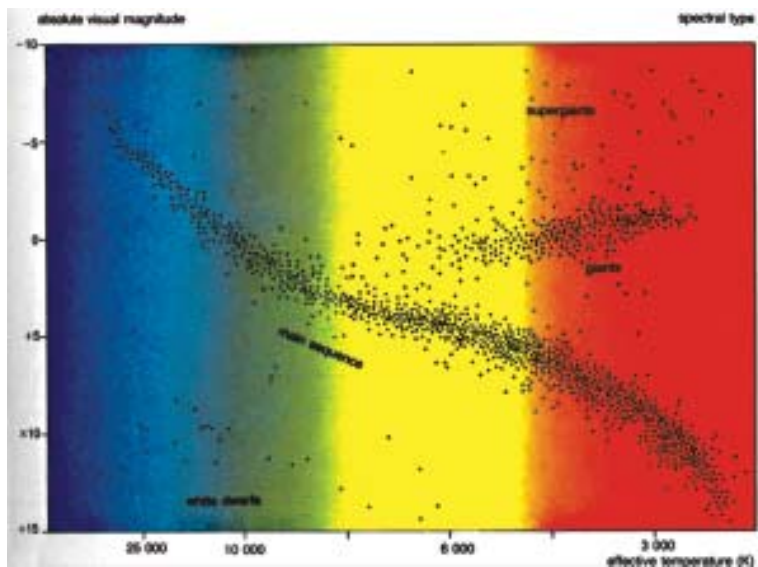

Fig: 11.22: **The Hertzsprung-Russell Diagram:** The x-axis denotes effective temperature in Kelvin of a star and the y-axis its absolute visual magnitude. Many of the stars are grouped along a narrow diagonal band called the 'main sequence'. The group of stars above the main sequence in the H-R diagram belong to the 'giant branch' and those with still greater luminosities are the 'supergiants'. The 'White dwarfs' are stars with very small radii and luminosities and appear much below the 'main sequence'.

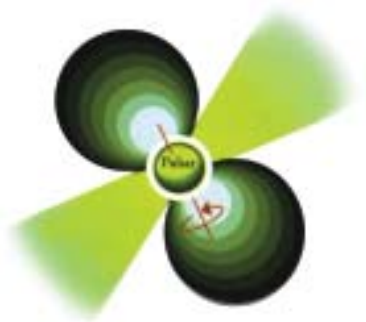

Fig: 11.23: In 1967 **Jocelyn Bell Burnell (1943-)** discovered the first pulsar, when she was a graduate student at the time. Pulsars are exceedingly dense stellar cores made of neutrons (Neutron Stars) in which the neutron degeneracy pressure balances the inward gravitational pull. Electrons spiralling along the magnetic field lines of a pulsar produce synchrotron radiation.



Fig: 11.24: **The Crab Nebula** was the first nebula to be discovered by Messier. This remnant of a supernova explosion is a strong radio source. It contains a pulsar with a rotational period of only 33 milliseconds.



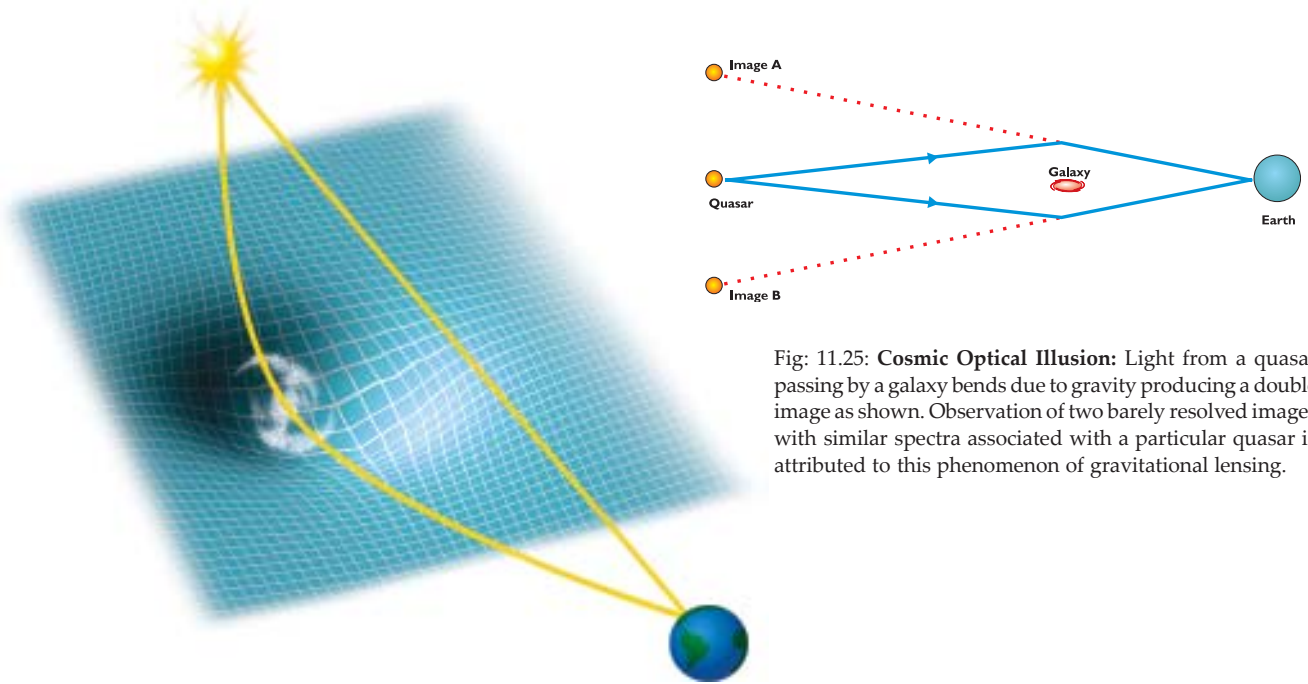

Fig: 11.25: **Cosmic Optical Illusion:** Light from a quasar passing by a galaxy bends due to gravity producing a double image as shown. Observation of two barely resolved images with similar spectra associated with a particular quasar is attributed to this phenomenon of gravitational lensing.

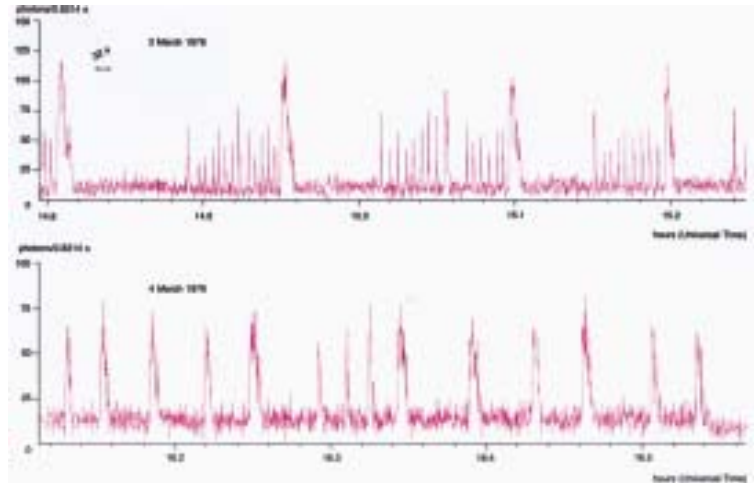

Fig: 11.26: **A Rapid X-ray Burster:** This X-ray burster located in a globular cluster has an average interval of a few tens of seconds between two outbursts. Many X-ray sources have been identified with white dwarfs, neutron stars and black holes. X-ray binaries constitute the largest class of bright X-ray sources.

Fig: 11.27: **Supermassive Black Holes as Galactic Nuclei:** The exceedingly bright nucleus at the centre of the Seyfert galaxy is attributed to very hot gas orbiting around a black hole of 108 solar mass. The lower photographs show the nucleus of the Andromeda galaxy with four different exposure times. Measurement of stellar velocities near the centre suggest the existence of a massive black hole.

Fig: 11.28: Gravitational lensing as seen by the Hubble Telescope

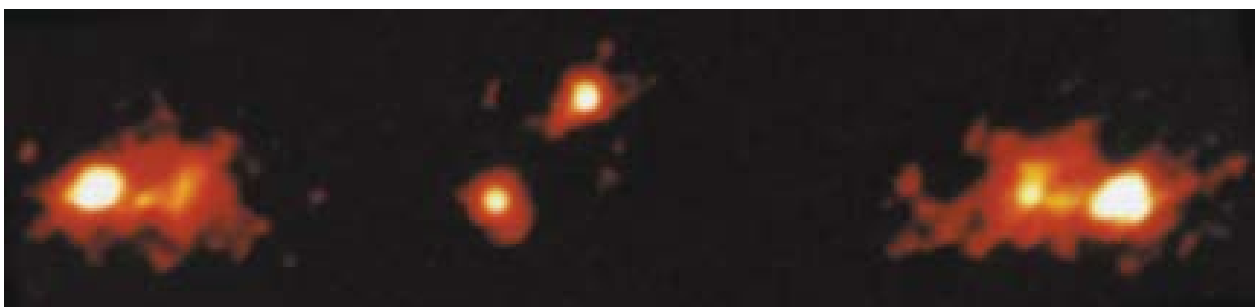
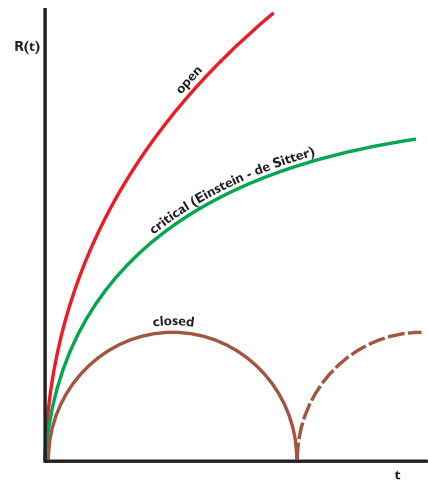



Fig: 11.29: **Roger Penrose (1931-)**, a theoretical physicist and a mathematician at Oxford, is one of the foremost researchers on the theory of black holes and quantum gravity along with Stephen Hawking.



$R(t)$	open	critical	closed
future evolution	expansion	expansion	contraction
curvature	hyperbolic	flat	spherical
density	$\rho < \rho_c$	$\rho = \rho_c$	$\rho > \rho_c$

Fig: 11.30: **The Fate of the Universe:** The evolution of the universe is determined by its average matter density. Beyond a critical $\sim 29 \times 10^{-30}$ value (10 g cm^{-3}) the universe must halt its expansion, contract back and end in a big crunch, perhaps only to start the cycle of expansion and contraction again.

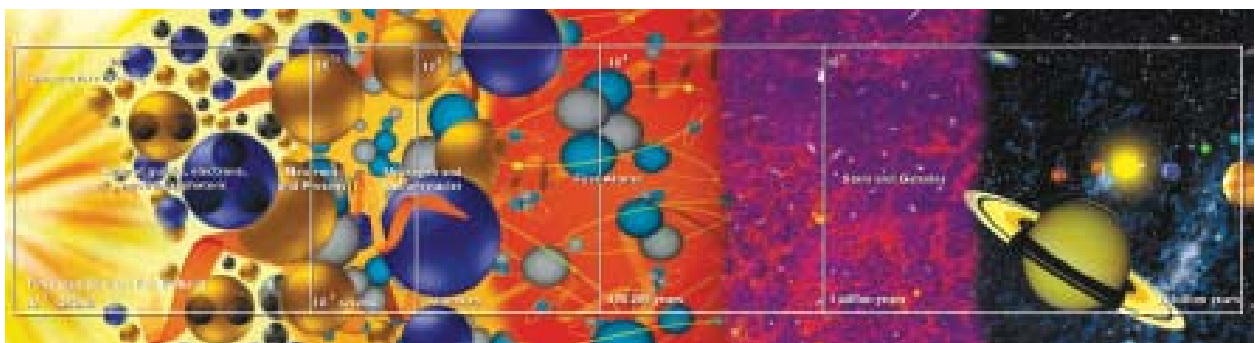

Fig: 11.32: **Stephen Hawking's (1942-)** contributions have been in the areas of general relativity, gravitation, and quantum theory in relation to black holes and their thermodynamics. Though afflicted by neuron disease since 1961, which has confined him to a wheelchair, he continues to be phenomenally productive as both a writer and a researcher.

Fig: 11.31: **The Hubble Space Telescope**, launched in April 1990, a joint European Space Agency and NASA project, has already made some of the most dramatic discoveries in the history of astronomy. Named after the American scientist Edwin Hubble, Hubble looks deep into space where some of the most profound mysteries are still buried in the mists of time.



Fig: 11.33: **History of Universe from the Big Bang**



12

Linguistics

Growth of Linguistics

Language as a discipline of objective inquiry began in the early civilizations of Greece and India. The origins of language, the relationship between words and objects were issues that provoked great debates among Greek philosophers. The Stoics introduced basic grammatical concepts (parts of speech, cases, etc.) and the first formal grammar of Greek was produced by 100 BC. The codification of Latin grammar by **Marcus Varro** (116-27 BC.) was the most significant linguistic work of the Roman period. This and later works on grammar determined the traditional approach to language teaching.

Phonetics, etymology, grammar and metrics rose to great heights in ancient India. The belief that the sanctity of Vedic hymns could be preserved only by rigorously accurate reproduction of the original texts motivated ancient Indians towards descriptive analysis of Sanskrit with remarkable detail and sophistication. Perhaps the greatest ancient grammarian of the world was Panini who lived around the sixth century BC. His grammar of Sanskrit captured in 4000 aphoristic statements employed methodological and theoretical principles that are relevant even in modern linguistics. The Middle Ages saw a similar tradition of Arabic language work related to the Quran.

Comparative philology began from the late 18th century with observations on the linguistic affinity between Sanskrit, Greek and Latin. From vast amount of empirical data on these languages, scholars attempted to reconstruct the parent language (Indo-European) that presumably existed before the earliest written records. Other groups of languages were similarly analysed and different families of languages were arrived at, each with different branches.

Fig: 12.1: William Jones (1746-94)



Indo-European Family of Languages:

The Sanskrit language, whatever be its antiquity, is of a wonderful structure; more perfect than the Greek, more copious than the Latin, and more exquisitely refined than either, yet bearing to both of them a stronger affinity, both in the roots of verbs, and in the forms of grammar, than could possibly have been produced by accident; so strong, indeed, that no philologer could examine them all three, without believing them to have sprung from some common source, which, perhaps, no longer exists.

This observation made by the British Orientalist William Jones in his presidential address to the Bengal Asiatic Society in 1786 was the first clear assertion of the existence of an original Indo-European language that evolved in course of time to the several modern languages of Europe and parts of southern Asia.

Pidgins and Creoles

A pidgin is a common system of communication used for trading and allied activities among people with different mother-tongues. It has limited vocabulary and narrow grammatical structure that can cope with only a small range of functions. Perhaps 'Bombay Hindi' could be considered an example of pidgin, but better instances are several pidgins based on European languages that arose in the colonial era. A creole is a pidgin that in course of time has become the first language of a group of people. It has much more evolved linguistic structures available and an expanded vocabulary. Goanese may be thought of as a Portuguese - based creole.

Twentieth century saw the emergence and union of two main approaches to linguistics, one European and the other American. The American approach spearheaded by the anthropologists arose from the need for descriptive analysis of the living American Indian languages for which no written records existed. Early pioneers of this approach were **Franz Boas** (1858-1942) and **Edward Sapir** (1884-1939). The European approach ushered in by the Swiss linguist **Ferdinand de Saussure** (1857-1953) was a reaction to the overly historical orientation of philology. Saussure's fundamental work *Cours de linguistique generale* was published in 1916. The central ideas of this work involved pairs of concepts such as 'Diachrony vs synchrony', 'langue vs parole', 'significant vs signifie' and 'syntagmatic vs paradigmatic' that played a foundational role in the development of linguistics.

Phonetics — the science of human speech sounds — developed from the need for accurate transcription of speech. An important advance was the concept of phoneme as a 'minimal unit of distinctive sound-feature' and that of a morpheme as the minimal unit of grammatical analysis. Particular attention was paid to the distinctive morphology and syntax of American Indian languages. L. Bloomfield's *Language* published in 1933 was a comprehensive work on linguistic theory and practice, which heralded the structuralist approach that dominated the subject for nearly two decades.

Fig. 12.2: Lexicography: The process of compiling dictionaries has a long history going back to ancient China, Greece and Rome. The first Sanskrit dictionary is said to have been compiled in the 6th century by Amarasimha. Kitab al'ayn, the first general Arabic dictionary, was compiled by Al-Khalil Ibn Ahmad in the 8th century. One of the most influential lexicographic works was the *Dictionary of the English Language* in two volumes compiled by Dr. Samuel Johnson in 1755.

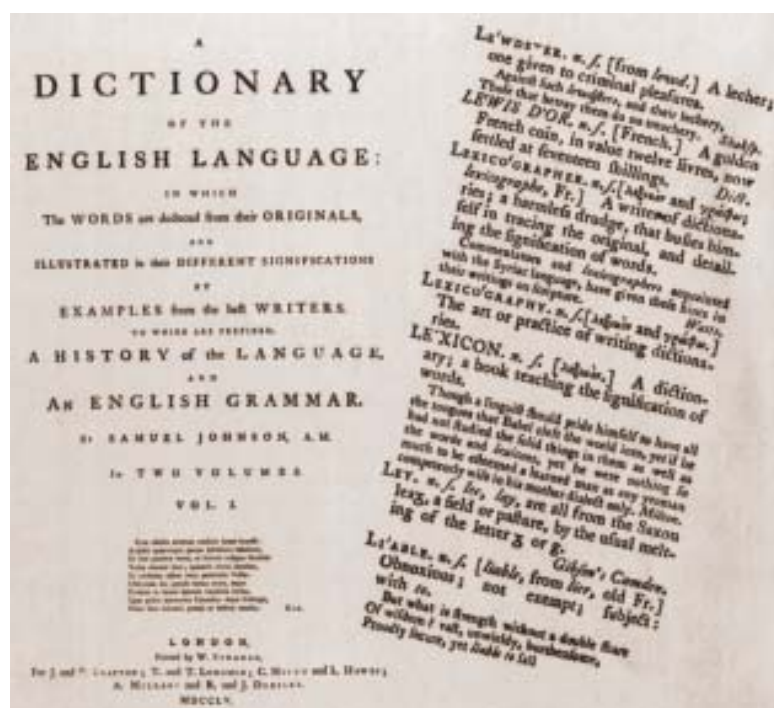
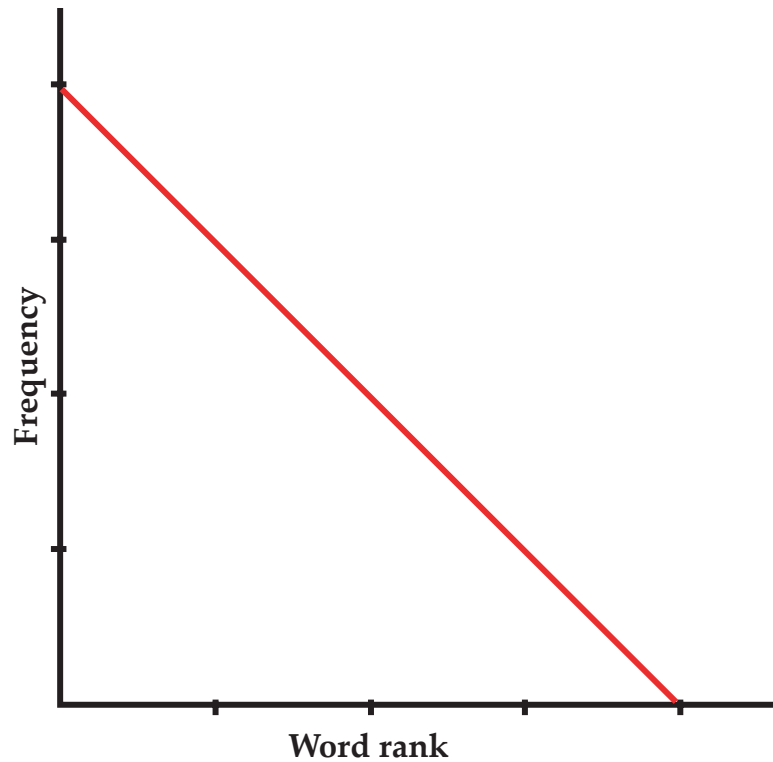

Fig. 12.3: Dr. Samuel Johnson (1709-84)



Fig: 12.4: **Zipf's Law:** Languages display interesting statistical regularities. One of the best known regularities is Zipf's law. Take any large passage from an ordinary book and obtain the frequency with which different words appear in the text. Rank the word with the highest frequency as 1, the next highest as 2 and so on. The product of rank and frequency is found to be approximately constant. (The graph is on logarithmic scale).



The pre-eminent linguist of the twentieth century has been **Noam Chomsky**, whose work *Syntactic Structures* (1957) marked a turning point in modern linguistics. This was followed by another important work, *Aspects of the Theory of Syntax* (1965). Chomskian approach stressed the fundamental difference between 'deep' syntax and 'surface' syntax of a language. Grammar was viewed as a device which generates all and only the grammatical sentences of a language. The infinite variety of sentences from a finite set of learnable grammar rules is accomplished through recursion. Starting from the initial element (any sentence), the different layers of the syntax are obtained by successive transformational rules leading to the final utterance — hence the name transformational generative grammar. The deep syntactic structures posited by this grammar were claimed to be universal.

The Chomskian revolution influenced behavioural science in general. The important distinction between 'performance' and 'competence' introduced in *Aspects* is now regarded fundamental to any learning process. Chomskian model strongly advocated a mentalistic view of language acquisition in direct opposition to the behaviouristic view. Together with the emerging views of cognitive development due to Piaget and others, it caused the decline of behaviorism in the latter half of the 20th century.

The original transformational generative grammar of Chomsky has seen several reformulations in recent decades and alternative models of grammatical analysis have also emerged. Semantics, the study of meaning, is no longer thought to be outside syntax but their precise interrelation can differ between different models. Modern linguistics is now a vast and elaborate subject that informs several other disciplines. The fields of machine translation and artificial intelligence have given rise to computational linguistics that uses the concepts of computer science. Socio-linguistics has given remarkable insights on how language is used as an instrument for social stratification. The Sapir-Whorf hypothesis posits that

Fig: 12.5: Edward Sapir (1884-1939)



language determines the basic framework of our cognition. Although the issues related to language and cognition are far from being resolved, the century has closed with a tantalizing, if controversial, view that our knowledge of the world is not objective but is largely constructed socially – through language and culture.



Fig: 12.6: Ferdinand de Saussure (1857-1913)

Saussuren Pairs of Concepts	
Diachrony (Historical Approach to language study)	vs Synchrony (Study of the State of the language as a whole at a given time)
Langue (the totality of a language- 'the sum of word-images stored in the minds of individuals')	vs Parole (The actual act of speaking of an individual)
Significant (the thing that signifies)	vs Signifie (the thing signified)
Syntagmatic (the relationship between signs of a sentence as a linear sequence)	vs Paradigmatic (contrasting relationship of the given sign with other signs in the language)

Indo-Aryan Languages constitute a large subgroup of the Indo-Iranian branch of the Indo-European family spoken by people in northern and central parts of the Indian sub-continent. Sanskrit, as we know it today, is the early form of the Indo-Aryan group in which were written the ancient Hindu scriptures – the Vedas. Buddhist and Jain literatures were mostly in the Prakrits – the later forms of the Indo-Aryan.

Fig: 12.7: **Branches of the Indo-European Family:** The Indo-European family is divided into some eight main branches distributed geographically over Europe and Asia.

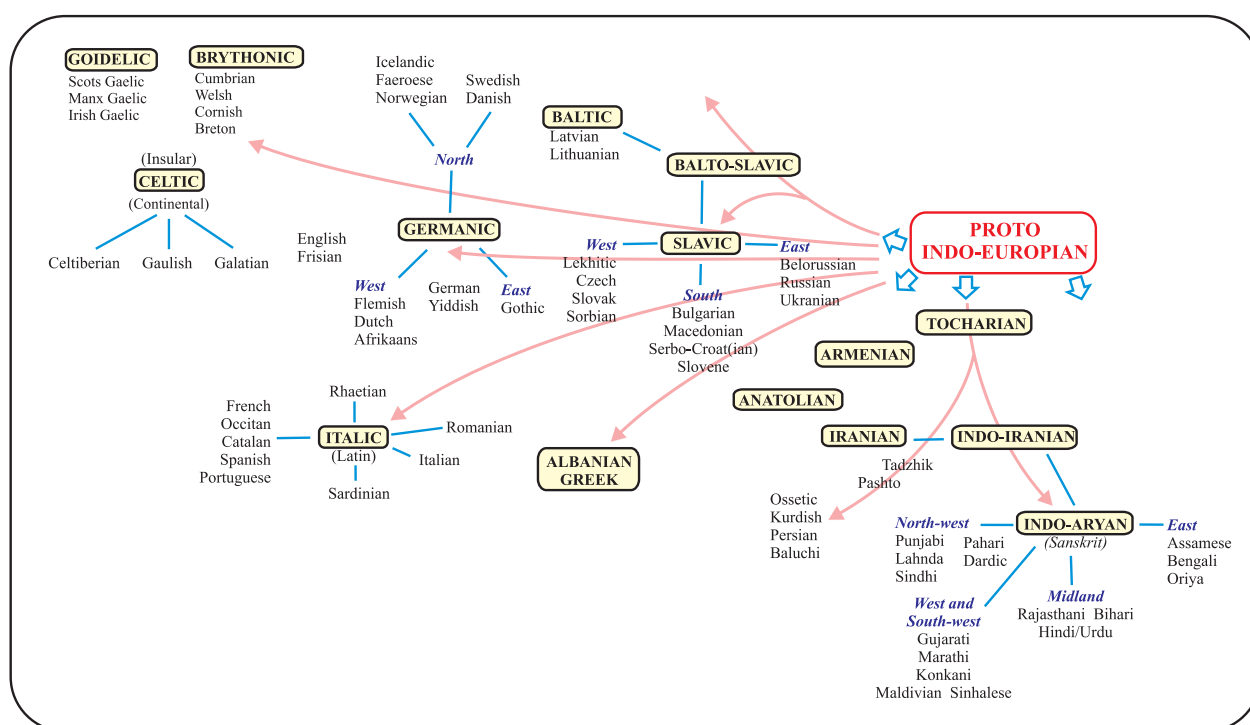



Fig: 12.8: Immediate Constituent (IC) Analysis of Leonard Bloomfield (1887-1949) looks at a sentence not as a linear string of elements but as one made of layers of constituents, resulting in a 'tree diagram' wherein each node is given an identifying label. Bloomfield's approach came to be called the structuralist approach in linguistics.

Phonemes and Morphemes

Human speech apparatus is capable of producing a wide range of sounds. Users of any particular language employ only a small number of these sounds which they distinguish from one other. A phoneme is not a particular sound, but an element of the interlocking network of contrasting sounds of a language. A certain range of physical sounds may be a single phoneme in one language and two or more phonemes in another language.

An utterance will not be meaningful if it is a mere arrangement of phonemes. Besides phonemic structure, there is another structure, that of morphemes. Morphemes are the smallest individually meaningful elements in the utterances of a language. They are the basic units of grammatical analysis.

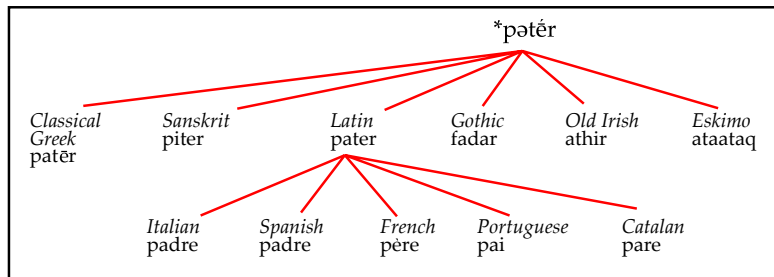

Fig: 12.9: Historical relationships between different languages are established by systematically comparing various words for a common concept, say 'father'



Fig: 12.10: Noam Chomsky (1928-)

Surface and Deep levels of Grammar

John is eager to please.
John is easy to please.

The two sentences have the same grammatical structure 'on the surface' but differ in their meanings. This is a famous example due to Noam Chomsky showing the need for going beyond the structuralist approach and looking for deeper levels of grammar.

Fig: 12.11: Chomsky's Transformational Grammar: Phrase structure rules generate a deep structure for a sentence, and transformational rules turns the deep structure into a surface structure. Deep structure is what is meant (semantic component), and surface structure is what we say or write (phonological component).

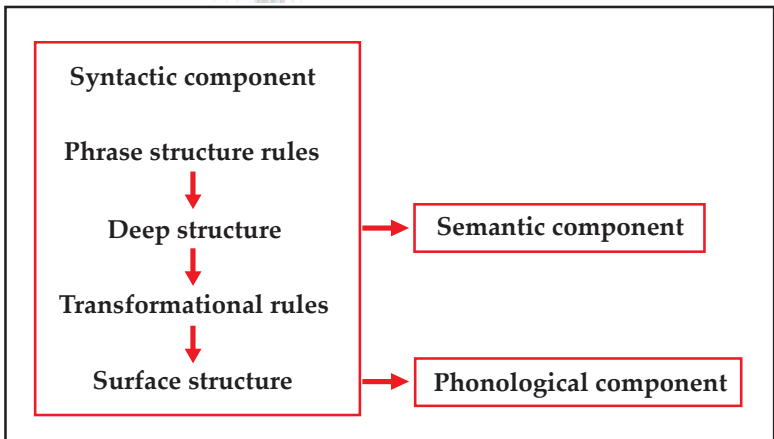

13

Psychology

The fundamental questions addressed by psychology have a long history, but scientific research in the discipline began only a century ago, with inputs from physiology. **Johannes Muller's** (1801-1858) pioneering work in neuro-psychology directed brain research to psychological questions such as the study of sensation. Experiments by **Gustav T. Fechner** (1801-87) on the manner in which physical stimuli are translated into psychological experiences led to the publication of the influential '*Elements of Psychophysics*' (1860). The first psychological laboratories were established around the 1870's by **Wilhelm Wundt** in Leipzig, Germany, and **William James** (1842-1910) at the Harvard University in the United States.

The influence of biology on psychology, more specifically that of Darwinism and the concept of evolution, was reflected in an increase in animal studies and the development of Behaviourism with its emphasis on the study of overt behaviour. Its major proponents were **Ivan Pavlov**, **Edward L. Thorndike** (1874-1949) and **Burrhus F. Skinner**. Subsequently, behaviourism has been applied with success in therapy and education.

Fig: 13.1: **Wilhelm Wundt** (1832-1920), and the Home of the Gaint building in Hiedelberg in 1865 where Wundt established his first laboratory.



Sigmund Freud (1856-1939) single-handedly developed, through his interactions with clinical patients, not only methods for treating psychological disorders but also a revolutionary theory of human development and personality which challenged the self-image of humans as rational beings.

An ongoing issue in psychology is the assessment of intelligence and personality. **Alfred Binet** (1857-1911) developed the first test of intelligence involving reasoning and problem solving. The War needs for assessment of individuals led to a phenomenal growth in intelligence testing in the US. At present IQ tests are a powerful tool with potential to do harm or good depending on their use.

The 'Gestalt school' (1911), whose basic argument is that the whole cannot be understood from knowing the parts, has regained popularity after its revival in cognitive psychology. **Jean Piaget's** (1896-1980) work on cognitive development in children, has had the most profound effect on modern psychology. Research in human information processing was further stimulated by Second World War, which required understanding interactions between humans and machines, and by the advent of computers. Important components of cognitive psychology are studies in thinking and memory.

Social psychology, in whose development **Kurt Lewin** played a major role, is among the more recent developments in psychology that have immediate practical significance. The research in the field covers attitude change, social inference and social facilitation of behaviour.

Twentieth century psychology is characterized by methodological rigour and relevance to day-to-day problems. Its multiple perspectives have their own domains and successes. At the beginning of the twenty first century, it is on the threshold of providing deep insights on the complex puzzle of human life and thought.



Fig: 13.2: **Ivan Petrovich Pavlov** (1849-1936) a Russian physiologist who in the course of his work on the digestive process developed a procedure for studying behaviour and a principle of learning that has had a profound effect in psychology.





Fig: 13.3: **Harry Harlow's (1905-81)** studies with monkey infants reared by artificial surrogates, shed some light on the issue of attachment among humans. One surrogate mother is made of wire with a block of wood for its head. The other surrogate is made of terry cloth and the head is covered with sponge rubber. Behind each 'mother' was a light bulb that provided radiant heat for the infants. For one group of infants, the wire mother had a nursing bottle while for the other group the cloth mother had a nursing bottle. All infants spent most of their time with the cloth mother regardless of which mother fed them.

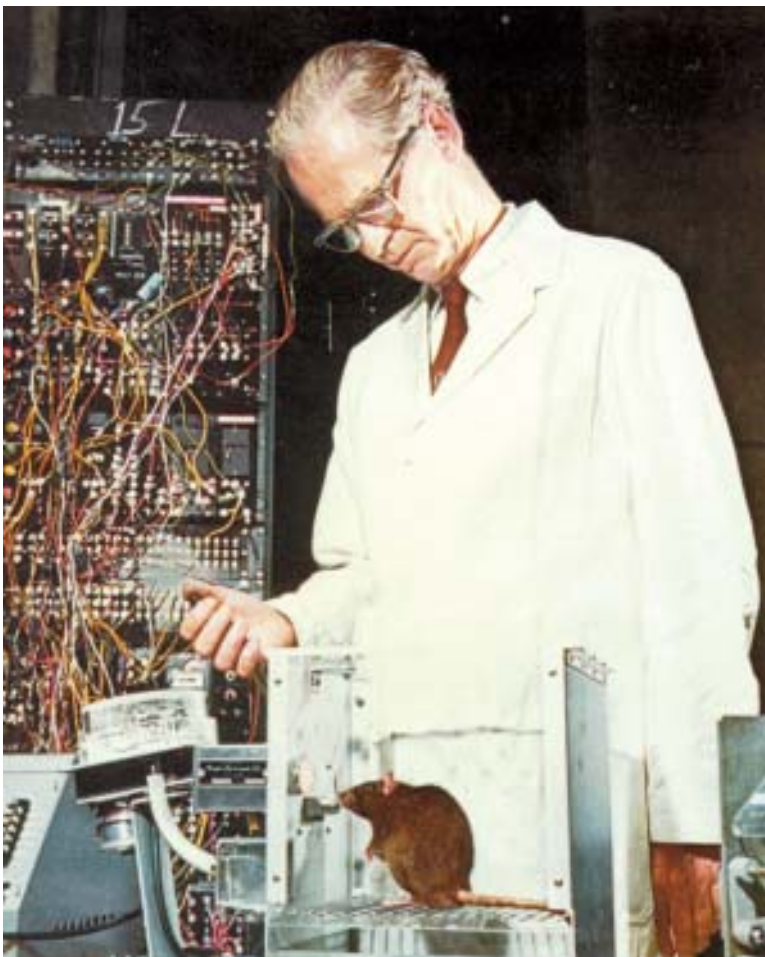

Fig: 13.4: **Burrhus Frederic Skinner (1904-90)**, famous for his support of an extreme behaviourist point of view. Here he is conditioning a rat to perform certain actions in exchange for food. This form of training called operant conditioning, is here being conducted in a soundproof, light resistant experimental chamber known as Skinner box, which is equipped with a cumulative recorder to measure the response rates.



Fig: 13.5: **Carl Jung (1875-1961)**: The concept of the 'collective unconscious' was introduced by Jung. In the illustration A and B refer to the Freudian concepts of the human mind, the conscious and the unconscious. Jung goes beyond these to the concept of a collective unconscious which holds the memories of all humanity and contains the roots of the four psychological functions, thought, intuition, feeling and sensation.

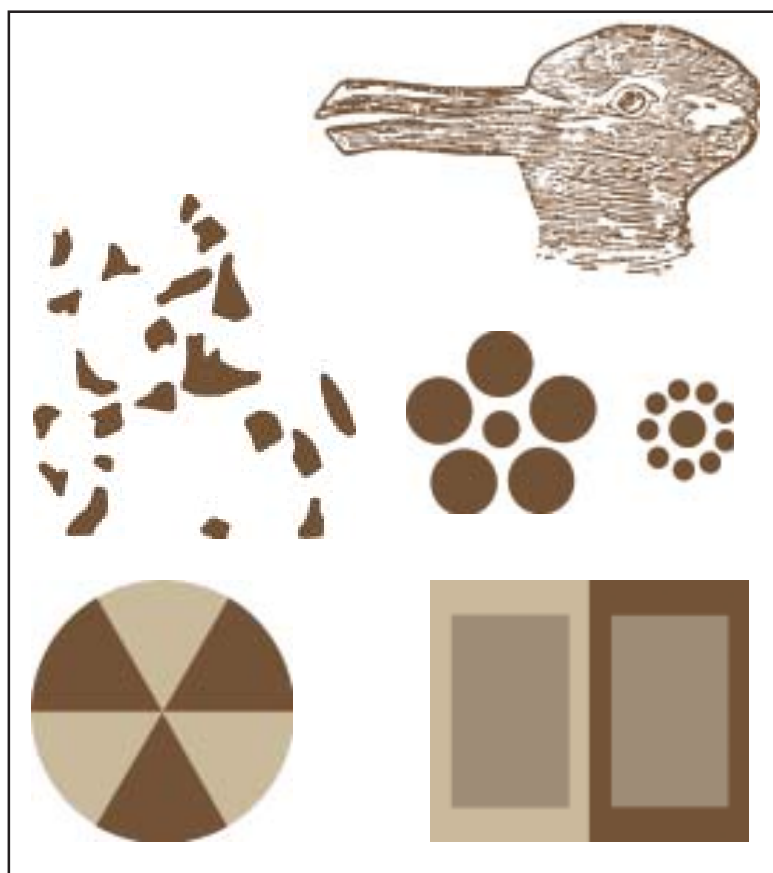

Fig: 13.6: **Sigmund Freud (1856-1939)**: An Austrian psychiatrist, Freud spent the early years of his medical career treating patients suffering from hysteria. His experiences convinced him that these patients were the victims of early traumas that had been pushed from consciousness. Among his important works are *The Interpretations of Dreams* (1900), *The Ego and the Id* (1923) and *Civilization and Its Discontents* (1930).





Fig: 13.7: Kurt Lewin (1890-1947) contributed to the development of social psychology.



Fig: 13.8: John B. Watson (1878-1958), showed how even fears can be conditioned with an eleven month old infant named Albert. His idea was that human behaviour is a bundle of conditioned responses.



Fig: 13.9: Alfred Binet (1857-1911) is known as the father of the Intelligence tests. He cautioned against the use of this test for labelling people. Intelligence tests are an important contribution of psychologists to the study of individual differences. The photograph depicts the items used in a memory test.

Fig: 13.10: The work of Loius Wain (an early twentieth century artist) depicting his advancing psychosis.



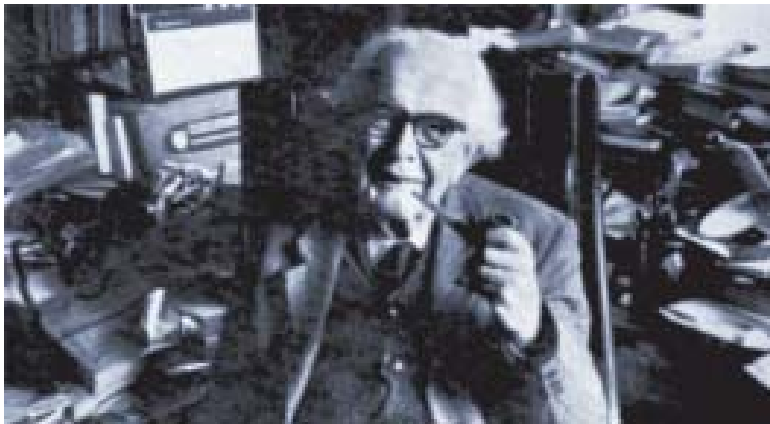

Fig: 13.11: **Jean Piaget's (1896-1980)** work on cognitive development led to experiments with young children to test the presence of concepts. The bottom pictures depict Piaget's experiments with young children demonstrating their lack of object permanence.



Fig: 13.12: **Eleanor Gibson** receiving the National Medal of Science in 1992, from the then president George Bush. At the age of 82, Gibson was honoured for a lifetime of research in developmental psychology. She is well known for her studies in depth perception, popularly the 'visual cliff' studies. Eleanor is the prototype of a devoted researcher who persevered in the face of major obstacles, such as, sexism.



14

Social Sciences

Sociology

The origins of social sciences lie in the Greek rationalist inquiries into the nature of humans, the State, and morality. These disciplines evolved slowly because of their close relation to theology. The notion of a science of society arose in the eighteenth century. The nineteenth century saw a clear separation between the social sciences and philosophy, under the influence of positivism which viewed every aspect of human behaviour as amenable to scientific investigation. The philosophy of humanitarianism remained linked to the social sciences, for the ultimate purpose of social science was thought to be the welfare of society. Today, the social sciences are perceived as disciplines that bear on the State policy. But the relation between social science and social policy is a vexed one.

The concept of 'civil society' as distinct from the State was expressed in the writings of Hobbes and Locke who anticipated the future focus of sociology. The concept of 'structure' present in the social sciences even today, was developed by these philosophers. **Auguste Comte**, the French positivist, used the term 'sociology' to describe the naturalistic science of society that would explain the past development of humankind and predict its future course. The study of social dynamics and social statics were the twin pillars of his



Fig: 14.1: **Auguste Comte (1798-1857)**, regarded as the founder of sociology conceived of The Law of Human Progress, wherein the evolution of human knowledge paralleled the evolution of the individual mind. There are three stages in the development: theological, metaphysical and scientific/positive. These stages were correlated with stages in the development of social organisations. His hierarchy of the Sciences is connected to the law of human progress. Thus astronomy the most general and simple science develops first, followed by physics, chemistry, biology and finally sociology.



Fig: 14.2: **Harriet Martineau (1802-76)**, an English sociologist who translated the works of Comte and provided insights into social behaviour. Her work mainly dealt with gender and race.

system. Towards the end of the nineteenth century, sociology came to achieve the status of an academic discipline. **Emile Durkheim** taught sociology at the Universities of Bourdeaux and Paris, brought out the journal *Année Sociologique* (1898) and founded the first major school of sociology: Functionalism. His work on suicide, religion, and crime are milestones in sociological thought.

Structural-functionalism spread rapidly in the United States and became the dominant theoretical perspective during the 1940's and 50's. It emphasized the consistency between structures, their functions and their role in the overall equilibrium and dynamics of the society. **Talcott Parsons** (1902-79) synthesized the disparate elements in the functionalist approach which was further refined by **Robert K. Merton**. German sociology had a strong base in the late nineteenth century, and the work of **Ferdinand Tonnies** (1855-1936), **Georg Simmel** and **Max Weber** were influential in all parts of the world. By the early 1930's, official hostility impeded its development and destroyed it as an academic subject in Germany.

Symbolic Interactionism, a leading perspective in sociology has roots in the works of Max Weber and Georg Simmel. **George H. Mead** (1863-1931) and **Charles H. Cooley** (1864-1929) are major figures in this perspective. It focuses on small-scale interactions and seeks to assign a central role to the meanings of actions of individuals. It defines society as an aspect of consciousness to be analysed in terms of individual thoughts, ideas, feelings and meanings, and dispenses with the notion of social structure. That this perspective has been productive is evidenced by **Erving Goffman's** (1922-82) dramaturgical vision in *The Presentation of the Self in Everyday Life* (1959) and *The Development of Labelling Theory* (1951).

In the 1970's, the Marxist perspective which offered a radical alternative to functionalism became increasingly influential and led to the development of the 'conflict school' of thought or 'critical theory'. Countries, such as, Japan, Israel and others are contributing to the growth of the subject. **Mysore Narasimhachar Srinivas** (1916-1999) explicated the concept of *Sanskritization* as a means of social upward mobility.



Fig: 14.5: **Emile Durkheim** (1858-1917) argued that there could arise through interactions between people certain new properties, not found in separate individuals. These 'social facts' (collective) needed to be studied at the sociological level. His works include *The Rules of Sociological Method*, *Sociology and Philosophy*, *Suicide*, *The Division of Labour*, *The Elementary Forms of Religious Life*, *Moral Education*, and *Education and Sociology*.



Fig: 14.3: **Herbert Spencer's** (1820-1903) primary concern was with evolutionary changes in social structures. His *Principles of Sociology* (1896) stressed the evolution of society towards increased specialization and complexity. His discussion of social institutions was expressed in functional terms.



Fig: 14.4: **Georg Simmel** (1858-1918) A German sociologist who is credited with laying emphasis on the importance of interaction processes within groups.

Fig: 14.6: Development and types of sociological theories

Core proposal	Theory type	Phase			Cognate disciplines (similar methodology and pattern of explanation)
		Classical	Modern	Contemporary	
Agency	Constructionism	Max Weber (1864-1920)	Symbolic interactionism	Structuration theory	Cultural anthropology
		Georg Simmel (1858-1918)	Phenomenology/ethnomethodology		History
System	Functionalism	Herbert Spencer (1820-1903)	Structural-functionalism	Neofunctionalism	Darwinian biology
		Emile Durkheim (1858-1917)			Ecology
Rationality	Utilitarianism	Alfred Marshall	Exchange theory	Rational choice	Neoclassical economics
		Vilfredo Pareto (1848-1923)			Public choice
Structure	Critical structuralism	Karl Marx (1818-83)	Critical theory	Communicationism	Structuralist linguistics
		Friedrich Engels (1820-95)	Structuralist Marxism		Poststructuralism

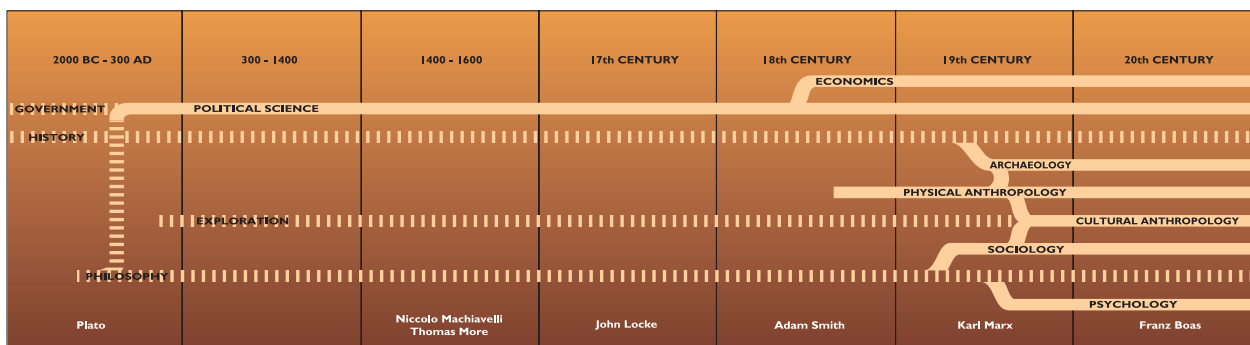

Fig: 14.7: Max Weber (1864-1920) focussed on the subjective meanings that human actors attach to their actions. Behaviour devoid of such meanings, according to Weber, is outside the purview of sociology. Weber developed the conceptual tool of 'Ideal type' for analytical purposes.



Fig: 14.8: Robert K. Merton (1910-), an American who has revolutionized our thinking about sociology, has been described as the last classical sociologist.

Fig: 14.9: Historical Development of Social Sciences



Anthropology

Anthropology is a science about human beings (anthropos). Of its two main divisions, physical anthropology views humans primarily as biological organisms while cultural anthropologists are concerned with the origin and development of cultures. The success of Darwinism reinforced evolutionary ideas in cultural anthropology. In the 1870's, evolutionists like **Edward B. Tylor** (1832-1917) and **Lewis H. Morgan** (1818-81), provided a linear interpretation of history. They maintained that cultures evolved from the simple to the complex, and all societies went through three basic stages: savagery, barbarism and civilization. The evolutionists' search for universal laws could not explain variations and regressions. Yet, the theory inspired many intellectuals, including **Karl Marx** (1818-83).



In the twentieth century, particularism arose as a reaction to evolutionism. According to **Franz Boas**, the search for universal laws is premature in the presence of the existing complexity of cultures. He advocated that cultural traits be studied in context and stressed the need to collect data before cultures disappeared. Boas undertook painstaking work with the Eskimos and singlehandedly trained many anthropologists in field work. His views on cultural relativism changed the nature of anthropology. Diffusionism, an unsatisfactory framework which caught the imagination of many, held that human beings are basically uninventive, and that all cultures share a common origin. The spread of traits explained cultural development. Similarities between cultures were explained as historical relationships and 'primitive' forms were considered to be the degeneracy of the original.

Bronislaw Malinowski (1884-1942) put forward the thesis of functionalism, according to which any cultural trait arises and

Fig: 14.10: The ethnologist studies cultures of the present. The heart of the ethnologist's approach is fieldwork where the researcher lives with the community she is studying. This method of data collection is also known as participant-observation.



Fig: 14.11: **Franz Boas (1858-1942)** was an eminent cultural anthropologist who led the opposition against evolutionism. He set high standards for anthropology by emphasising fieldwork. He introduced the notion of cultural relativism (a culture to be judged according to its own standards and values) and he believed in historical particularism (each culture has its own unique history). Franz Boas studied the Kwakiutl Indians and made famous their feasts which were called 'potlatches'.

persists if it is functional. This explanation has been very productive but is often accused of being an argument in favour of the maintenance of the status quo. The structuralist viewpoint holds that the social system is not merely a sum of social relations but has an independent existence which members of the society are unaware of. **Claude Levi-Strauss** views culture as a surface representation of the underlying structure of the human mind and its cognitive processes.

Freudian influence resulted in attempts at understanding how psychological factors relate to cultural practices. This is exemplified by **Margaret Mead's** study in 1920's, of three different societies in New Guinea, showing different patterns of sex differences in personality. The study emphasized that culture, rather than biology plays an important role in producing sex differences. **Ralph Linton** (1893-1953) and **Abram Kardiner** (1891-1981), in the 1930's, suggested that every culture has a 'basic personality'. Various studies on national character were conducted during the Second World War, which attributed the apparent personality traits of different nations to aspects of child rearing.

The 'interpretive approach' and 'cultural ecology' are newer perspectives in anthropology. The former has origins in literary criticism, and considers the researcher as an interpreter, who analyses the meaning of cultural practices. The latter approach focuses on the interactions of specific cultures and their technologies with their environments.



Fig: 14.12: **Bronislaw Malinowski (1884-1942)**, born in Krakow, Poland to an academic family. He believed that the origin of cultural traits could be discovered by analysing the ways in which a culture fulfils the biological, instrumental and integrative needs of its members. His study of the Trobriand Islanders focussed on associations between social interactions and magic, religion and kinship.



Fig: 14.13: **Alfred Reginald Radcliffe- Brown(1881-1955)** an Englishman who led the structuralfunctional school in anthropology.



Fig: 14.14: **Ruth Benedict(1887-1948)**: Culture according to Ruth is nothing but personality written on a large scale. Her *Patterns of Culture* (1934) popularised the idea of cultural variation and the influence of culture on personality.



Fig: 14.15: **Margaret Mead's (1901-78) *Coming of Age in Samoa* (1961)** stimulated an interest in child-rearing practices as these were accorded the highest importance by her in explaining both cultural behaviour and personality.

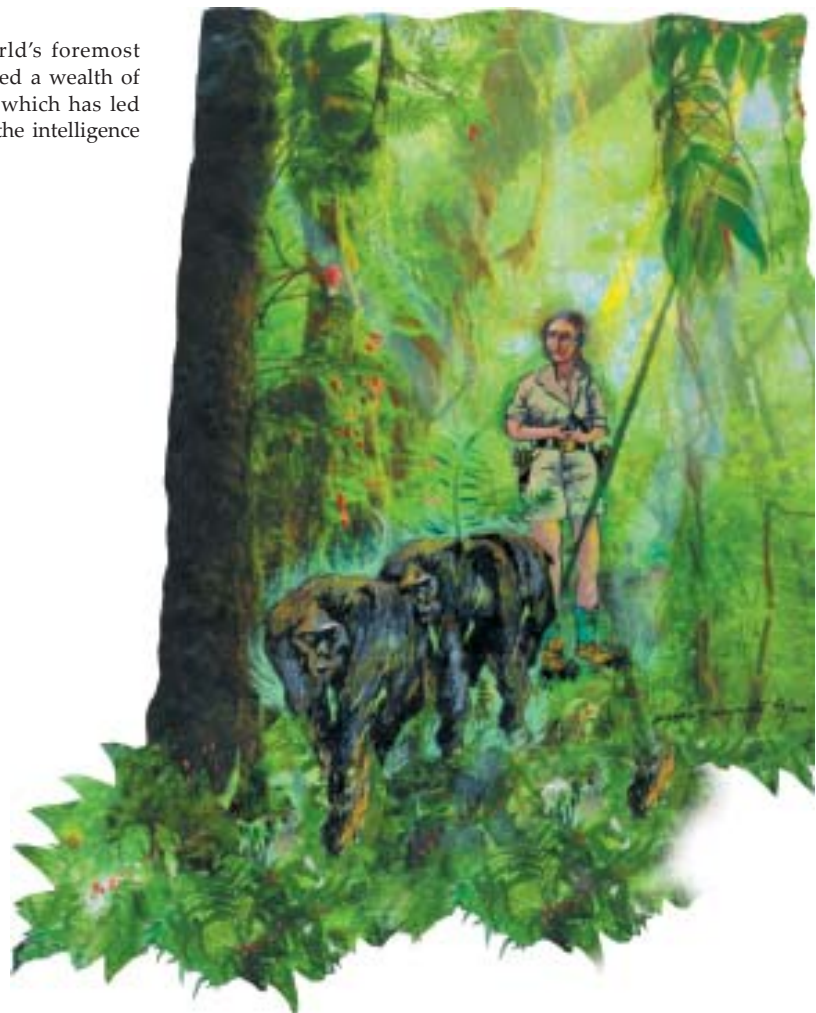

Fig: 14.16: **Claude Lévi-Strauss (1908-67)**, a French anthropologist who is the most prominent advocate of the structuralist approach to analysing cultures.



Fig: 14.17: The chief concern of physical anthropology is the evolution of humans. Through the analysis of fossils and observation of other living primates, attempts are made to trace human ancestry.

Fig: 14.18: **Jane Goodall (1934-)** is the world's foremost authority on chimpanzees. She has contributed a wealth of information concerning primate behaviour, which has led anthropologists to reevaluate theories about the intelligence and learning capabilities of primates.



Economics

The first of the social sciences to attain the status of a single and separate science was economics. Its initial concerns were with the behaviour of economic aggregates (macroeconomics). There have existed two contrary themes in economics since its inception. The Mercantilists (European merchants and government officials during the seventeenth century) advocated that the government use its powers to alleviate conflicts in the economy while the French physiocrats ('rule of nature') constructed a theory of an ideally functioning economy based on the principle of *laissez faire*.

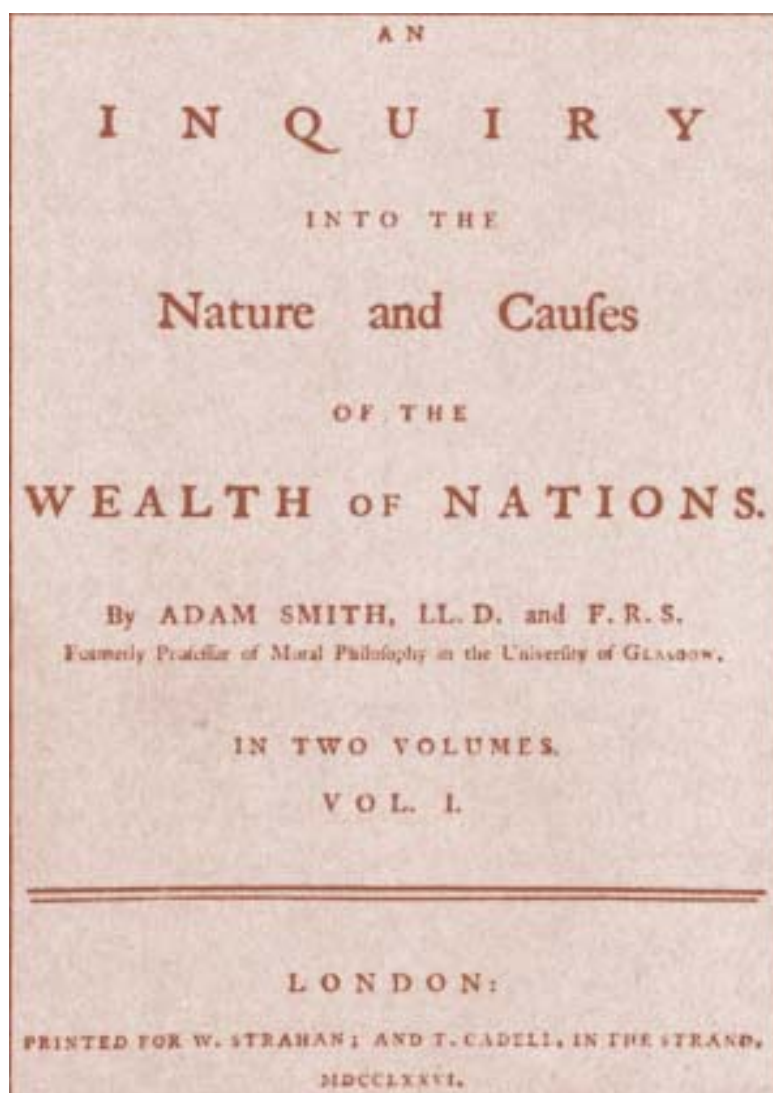

Fig: 14.20: Adam Smith's classic *An Inquiry into the Nature and Causes of the Wealth of Nations* was published in 1776.

Adam Smith in his *Inquiry into the Wealth of Nations* (1776), stated that the natural trend of economic development would manifest itself in a system of liberty. He proposed that an 'invisible hand' through the principle of competitive equilibrium guided the affairs of the economy. These views were buttressed by **Jean-Baptiste Say** (1767-1832) who used deductive methods to derive laws that govern production, distribution and consumption of wealth.

Thomas Robert Malthus (1766-1834) known for his pronouncements on population growth was a professor of political



Fig: 14.19: **Adam Smith** (1723-1790): Almost all economic thought can be traced back to this Scottish professor who combined a grasp of particulars with a capacity for seeing theoretical relationships that gave the particulars significance.

Fig: 14.21: **James Mill** (1773-1836)





Fig: 14.22: **David Ricardo (1772-1823)** was a British businessman who made a fortune buying and selling stocks and who retired in his middle age to devote himself to the study of economics. Ironically, this amateur economist turned out to be more systematic than professionals. His *Principles of Political Economy and Taxation* broke a new ground in the development of economics.

economy, who in his later works raised the problem of depressions. **David Ricardo**, **James Mill** and **Carl Menger** elaborated on what is today called 'classical economics' founded by Adam Smith. The Utopian socialists were nineteenth century economists unconvinced by classical economics. They were taken seriously because conditions under laissez faire were highly unsatisfactory for workers. The historical economists in Germany also contested the universal and timeless quality of economic behaviour proposed by the classicists.

Influenced by Hegelian philosophy and the dialectical method of change, **Karl Marx** put forward the thesis that the prime movers of change were changes in the modes of production. Marx viewed capitalism as a transitory stage in the historical evolution of society, to be followed by a more humane and realistic economic system based on co-operation, people's ownership of means of production and planning. Marx remains a formidable name amongst intellectuals and continues to influence the content and contexts of even the most abstract social sciences.

Neo-classicism was a reaction to the indictment of capitalism. **Alfred Marshall (1842-1924)** symbolized this view, which explained economic phenomena as the outcome of rational choices of people (micro economics). Marshall's book '*Principles of Economics*' presented a complete version of the marginal utility theory.

In the 1930's, during the period of the Great Depression, **John Maynard Keynes** argued that market forces alone could not be relied upon and direct intervention by the government was often necessary. Keynes's name has become associated with democratic economic planning.

Recent approaches to economics involve modelling of relationships between economic variables. Such models can encompass an entire national economy or single markets and can be checked against statistical evidence or used to make predictions. Analysis of data for the purpose of discovering empirical relationships is called econometrics. Another application of mathematics to economic analysis is game theory, developed largely by **John von Neumann (1903-57)** and **Oskar Morgenstern (1902-77)**. However, not all present day economists use mathematics because they claim that the answers obtained depend upon the assumptions underlying the equations.

Fig: 14.23: The neoclassical theory of prices, combining the concepts of equilibrium and optimization has formed the base of modern economic theory. The neoclassical theory of prices, combining the concepts of equilibrium and optimization has formed the base of modern economic theory.

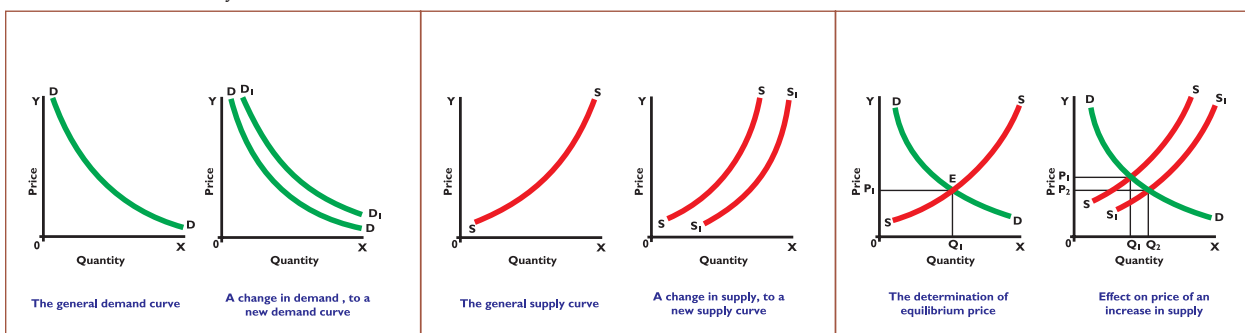

		Prisoner I	
		confess	not confess
Prisoner II	confess	4 4	6 1
	not confess	6 1	0 0

Fig: 14.24: Games are models of real life situations, the basic function of which is to intensify human experience in ways that are relatively safe even when they provide excitement. The theory of games is the mathematics of co-operation and competition. Game theory became famous with the publication of Jon von Neumann's *Theory of Games and Economic Behaviour* (1944). The theory of co-operative games is concerned primarily with 'coalitions' - groups of people who coordinate their actions and pool their winnings. The illustration depicts a game called *Prisoner's Dilemma* in which two prisoners are interrogated by the police.

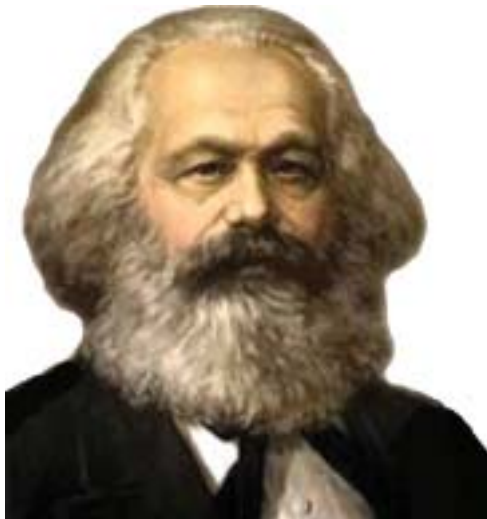

Fig: 14.25: Karl Marx's (1818-1883) monumental thesis *Das Kapital* (1867) had a tremendous influence on various spheres of society. It has stimulated intellectual thought since. Karl Marx is considered the cooriginator of Communism as a philosophical alternative to the existing economic system.



Fig: 14.26: John Maynard Keynes (1883-1946) is the most influential economist of the twentieth century. His reputation was established by his advocacy of government spending to relieve unemployment.

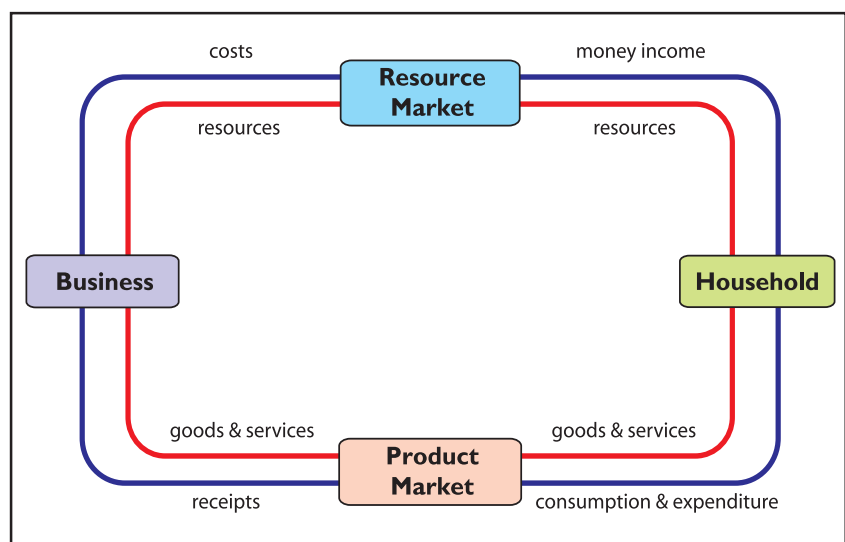

Fig: 14.27: **The Circular Flow of Income and Output:** The functioning of the national economy can be visualised in terms of a circular flow diagram.



Fig: 14.28: Amartya Sen (1933-) received the Nobel Prize in 1998 for his contributions to welfare economics.

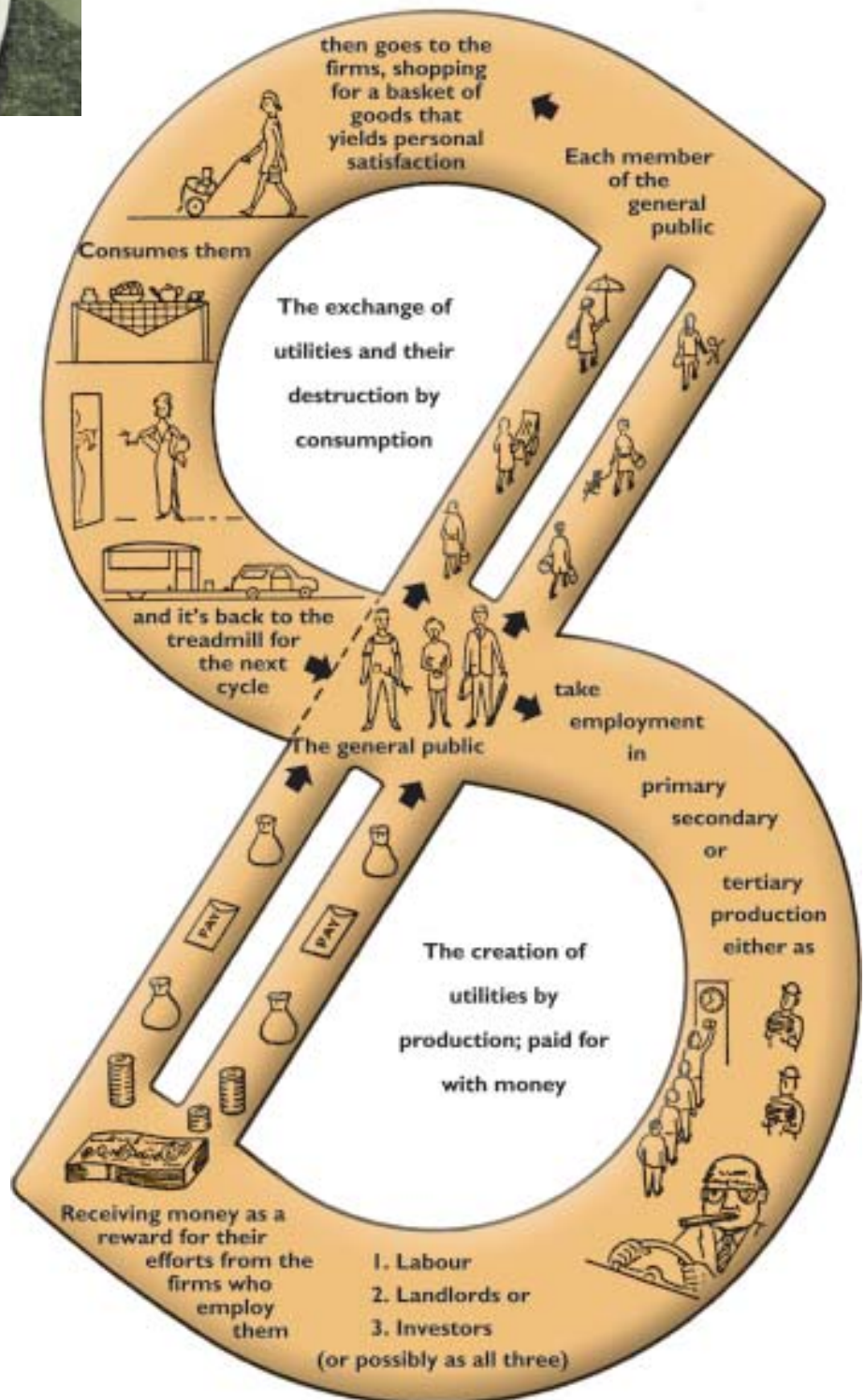

Fig: 14.29: The Money System

15

Earth Science



Fig: 15.1: "Foot Prints" of icebergs found in Sahara.

Discoveries from the great voyages made by Europeans (between the 15th and 17th centuries), like **John Cabot** (c.1450-99), **Ferdinand Magellan** (1480-1521) and **Christopher Columbus** (1451-1506) contributed to great advancements in the maps of the world. The earliest map on which the name 'America' appeared was prepared in 1507 by **Martin Waldeseemuller** (c.1470-1522). **Gerard Mercator** (1512-94) founded a map making house and **Abraham Ortelius** (1527-98) published the first modern atlas in 1570.

The pressing need, triggered by the industrial revolution, for exploring mineral and ore resources drew Europeans to practical applications of earth science. **Georgius Agricola's** (1495-1555) treatise on mineralogy and mining, published in 1556, marked the onset of the new era.

The English land surveyor and canal engineer **William Smith** (1769-1839) discovered that various strata around Bath could be distinguished by their fossil assemblages. He used this discovery in the construction of geological maps (1740). This was really the beginning of stratigraphical studies, and geological maps too. Fossil remains, which were being discovered all around the world at the time, increasingly called into question Biblical accounts of the age of the earth.

William Nicol (c.1771-1851) of Edinburgh developed the petrological microscope in 1830. Nicol was initially ridiculed by many for attempting to study the structure of a mountain through a microscope. The microscope however, soon proved to be an extremely useful and valuable device to study rocks for their minerals, cleavages, etc. In fact this device paved the way for the science of petrology, the study of rocks.

The invention of the seismograph in 1855, a century after the disastrous Lisbon earthquake of 1755, laid the foundation for seismology — the science of earthquakes. Advancements in physics

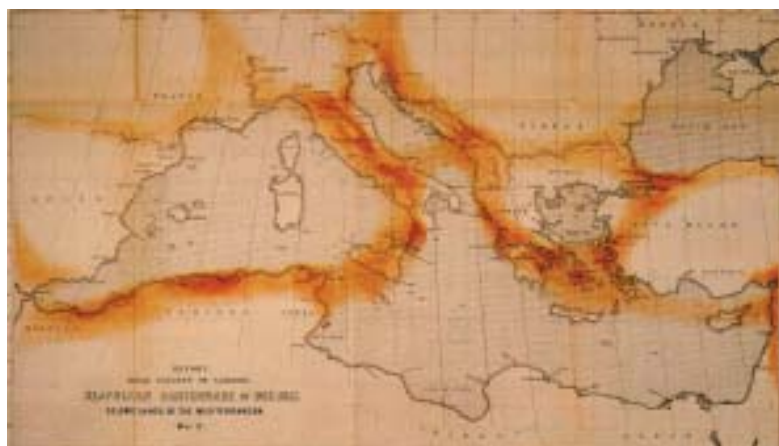

Fig: 15.2: The first map of seismic zones drawn by Robert Mallet (1810-81) on the basis of historic data of earthquakes.

and technology led to dramatic improvements in the design, sensitivity and recording mechanisms of seismographs. Over time, seismology has become a very powerful tool for investigating the interior of the earth and in the search for crust minerals and oil resources. Seismographs set on the moon by the Apollo astronauts, have not only continued to provide detailed information of Lunar-quakes, but have also helped in understanding the moon's interior and the absence of a continuous bedrock there.

Some of the techniques developed during the Second World War, purely for military purposes, found direct application in the earth sciences. Ocean floor mapping and remote sensing are just such examples that soon triggered leaps in our understanding of the earth. The efforts of a French army engineer, **Aime Laussedat** (1819-1907), in the 1850s, of mounting cameras on kites and balloons, led to aerial photography. Virtually every development in remote sensing has stemmed directly from military application. Infra-red photography, thermal imagery, air borne radar, have all proved powerful tools in the earth sciences. Lord Rutherford's discovery of radioactive decay (1905) provided a key to the quantitative measurement of geological time. It actually began the era of radioactive dating allowing remarkable precision in dating many of the rocks, fossils, etc.

Alfred Wegener in 1912 suggested that the present day continents originally were a single large supercontinent, from which a few plates progressively drifted apart. Studies in palaeomagnetism of rocks in 1960s confirmed that the continents have indeed shifted their positions. This discovery, commonly known as *the theory of plate tectonics*, can be rated as the single most startling discovery in geology. However other recent discoveries such as the reversals of earth's magnetic polarity, recent ice-ages etc., are no less significant.



Fig: 15.3: 72 feet quartz rod strain seismograph in a mountain tunnel.

Fig: 15.4: **Alfred Wegener** (1880-1930) proposed the hypothesis of continental drift in early 1912. Nine years later he published the book *The Origin of Continents and Oceans*.



Fig: 15.5: Mechanical seismograph system used in early years of this century.

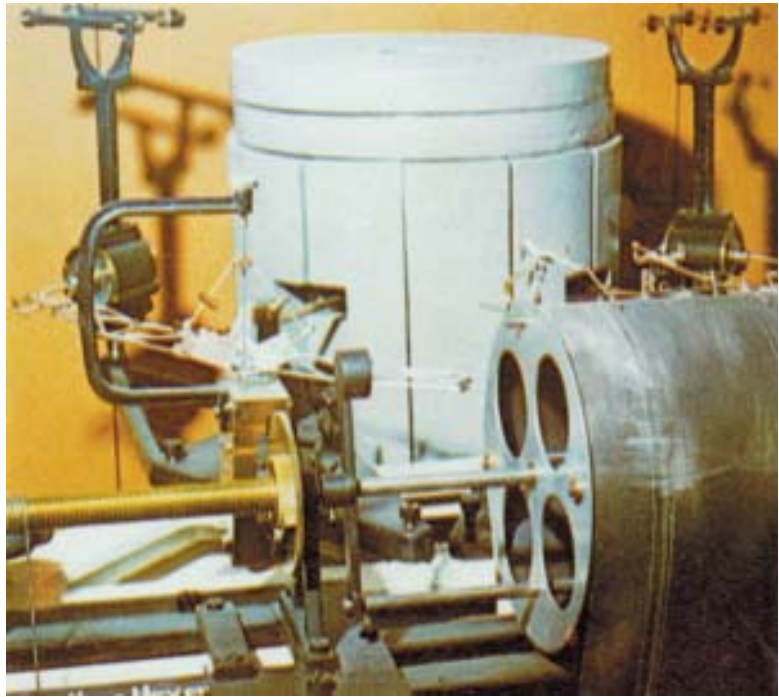

Fig: 15.6: **Gondwanaland:** Eduard Suess (1831-1914) proposed that the southern continental mass of the Pangaea be called Gondwanaland, after a region inhabited by the Gonds in India. The picture shows the drifting apart of the continents.

Fig: 15.7: **Larderello geothermal field** in Italy has been used for generating electric power since 1904. It has now a capacity of 380,000 kilowatts.



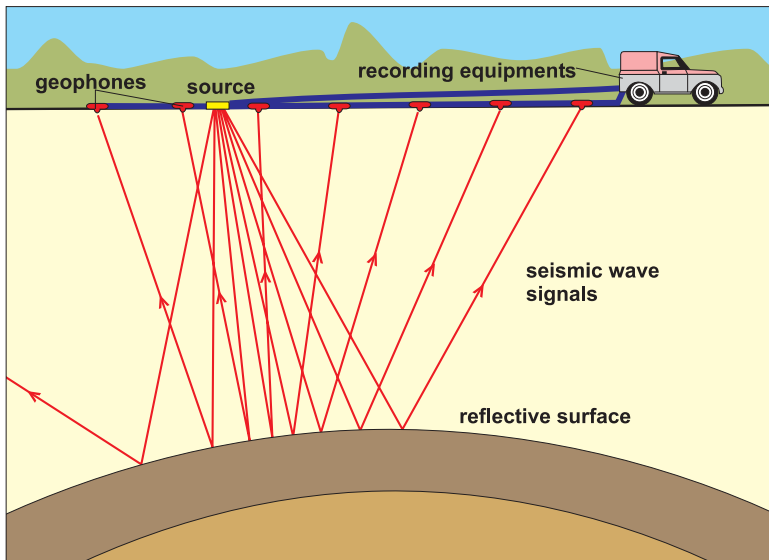
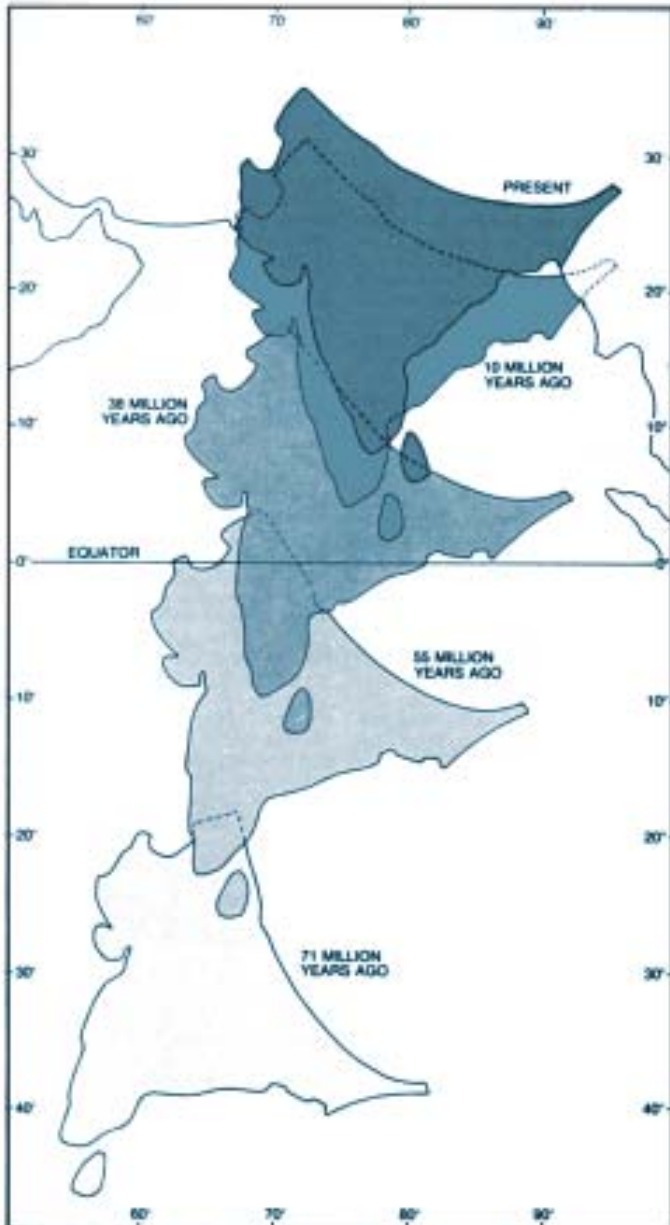

Fig. 15.8: Use of Seismology for mineral exploration.

Fig. 15.9: India's northward drift — reconstructed from magnetic reversals in the floors of the Indian and Atlantic oceans. In the past 70 million years, the north-eastern tip has actually travelled some 7,000 km!



200 million years ago



135 million years ago



65 million years ago



today

Fig. 15.10: Changing faces of Earth through the ages

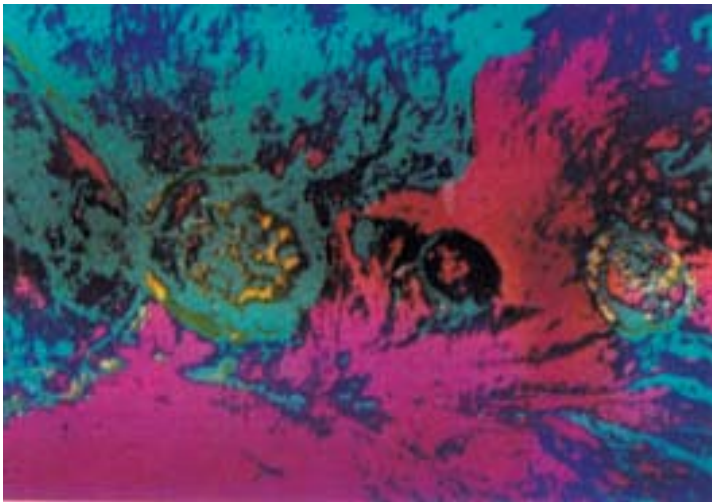

Fig: 15.11: Thermal infrared line scan image of the volcano Mauna Loa in Hawaii. The crater interiors (blue) are relatively cool. Pink and yellow indicate the main areas of thermal emission.

Fig: 15.12: **Alvin**, a **manned submersible** with sophisticated navigation, photographic and sampling systems — a new dimension in the study of sea-floor spreading.



Fig: 15.13: A true-colour aerial photograph of farmland and developed forestry and a false-colour infrared photograph of the same scene.



16

Physics in twentieth century

At the end of the last century, classical physics epitomized the very success of science. Its three main disciplines mechanics, electrodynamics and thermodynamics phrased in elegant mathematical language, provided a quantitative explanatory framework for understanding physical phenomena. Little did any one anticipate that this magnificent edifice was soon to be shaken to its very foundation by two intellectual tempests: quantum mechanics and relativity. The quantum revolution originated in the failure of classical physics to explain adequately several observed phenomena: blackbody radiation, photoelectric effect, low-temperature specific heats of substances, etc. There was no way to understand in the classical paradigm, the size, stability and spectra of atoms. By 1927, through a tortuous interplay of theory and experiment, physicists arrived at a queer new science for the atomic domain in which the basic laws could only give probabilities of values for observables and events.

The second great revolution of the century, the relativity of Einstein, dramatically altered our concepts of space, time and mass. Special relativity kept Maxwell's electrodynamics untouched, but modified Newtonian mechanics fundamentally, with observable consequences at high speeds. Its general version fashioned by Einstein modified Newtonian theory of gravitation and introduced one of the most profound ideas ever conceived by a human linking gravitation to the (curved) geometry of space and time.

Fig: 16.1: **The Michelson-Morley Experiment** proved the non-existence of ether. A beam of light was split into two, and they were made to travel at right angles to each other by a set of mirrors. In the course of the movement, if the Earth was moving through the ether, the two beams should become slightly out of step, and should produce interference fringes when the beams were brought together. No such fringes were ever seen, indicating the absence of ether.

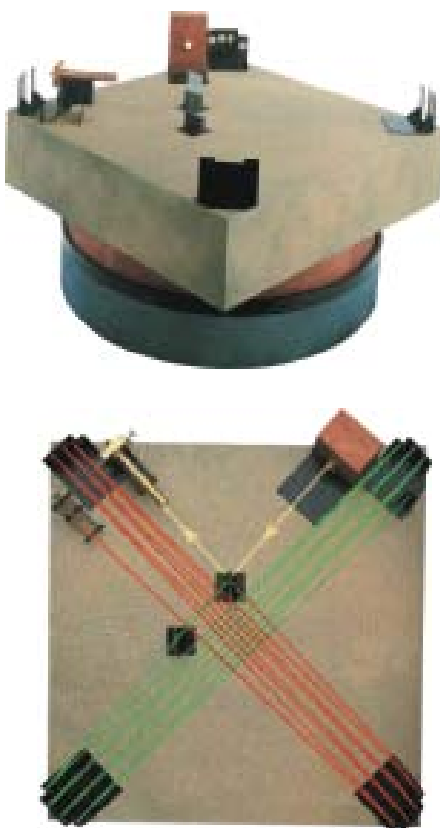

Fig: 16.2: Albert Michelson (1852-1931)

Fig: 16.3: Edward Morley (1838-1923)



On the experimental front, the atom was probed at increasingly deeper levels. Among the early milestones were the discovery of neutron by Chadwick and of positron by Anderson. The latter, identified as antielectron, exemplified the fundamental notion of antimatter. In time came a host of discoveries in sub-atomic physics: nuclear fission (and later nuclear fusion), neutron-induced chain reactions, culminating in nuclear reactors and nuclear weapons the latter, a monstrous verification of the mass-energy 2 equivalence relation $E = mc$ given by Einstein's relativity. High energy experiments, first with cosmic rays and later with accelerators of growing size and energy led to the discovery of a plethora of sub-atomic particles: the so-called baryons, mesons and leptons.



Fig: 16.4: **Max Karl Ernst Ludwig Planck (1858-1947)**: Planck's work was a turning point in the history of physics. Experimental observation on the wavelength distribution of the energy emitted by a black body as a function of temperature was at variance with the predictions of classical physics. Planck deduced the relationship between the energy and the frequency of radiation. In a paper published in 1900 he announced the revolutionary idea that the energy emitted by an oscillator could only take on discrete values or quanta.

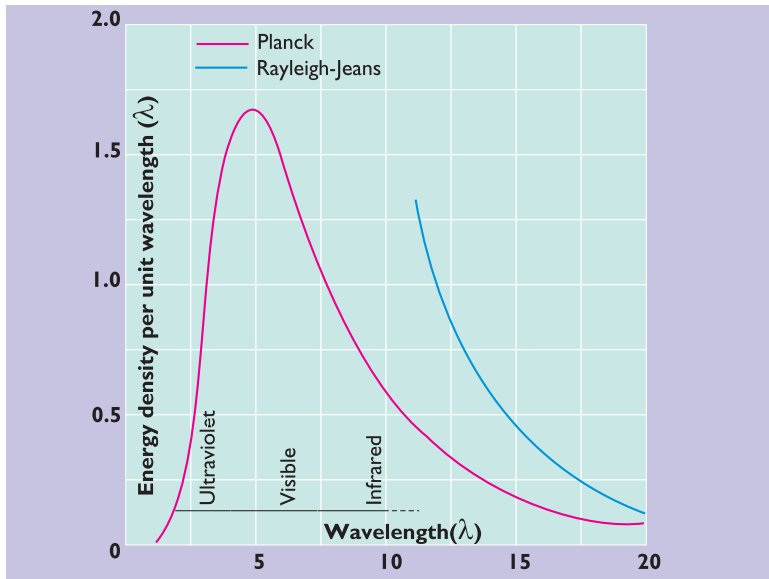

Fig: 16.5: **Albert Einstein (1879-1955)**: His three papers in 1905 on light quanta, Brownian motion and special relativity were basic to much of twentieth century theoretical physics. Einstein's general theory of relativity completed in 1916 is regarded as one of the greatest intellectual creations of the human mind.

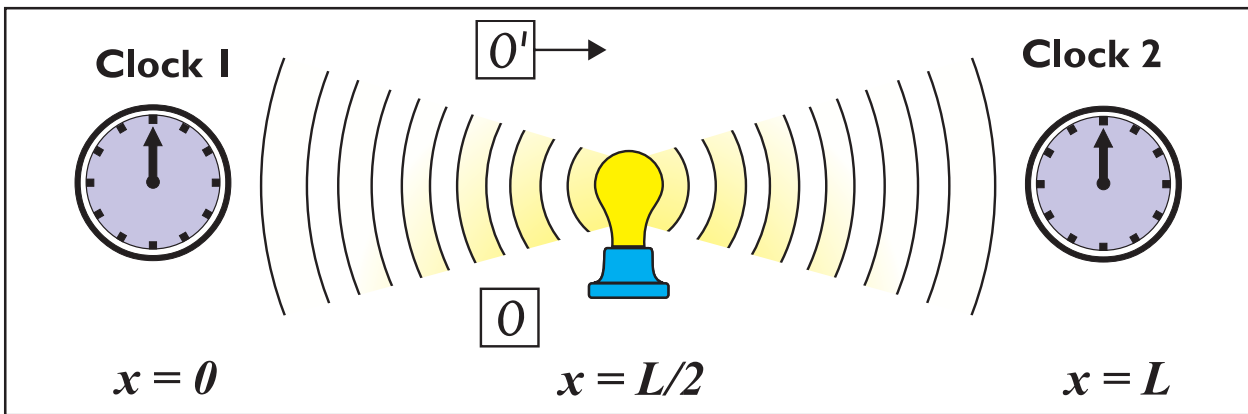

Fig: 16.6: **The Special Relativity of Einstein:** A flash of light is emitted from the mid-point between two clocks. For the observer O, the light signal reaches the two clocks at the same time. For another observer O' moving relative to O, the signal reaches clock 2 earlier than clock 1. This relativity of simultaneity is basic to many of the baffling consequences of Einstein's special relativity discovered in 1905. The special relativity valid for inertial observers in relative motion was generalized by Einstein in 1915 to include observers in arbitrary motion. The general relativity is the modern theory of gravitation.

Fig: 16.7: **The photon picture of electromagnetic radiation:** In 1905, Einstein contended that the observed features of photoelectric effect could be accounted for if light was regarded as consisting of localized packets of energy (photons). In 1923, Arthur Compton's experiments on scattering of X-rays by the (nearly) free electrons of a target verified this picture.

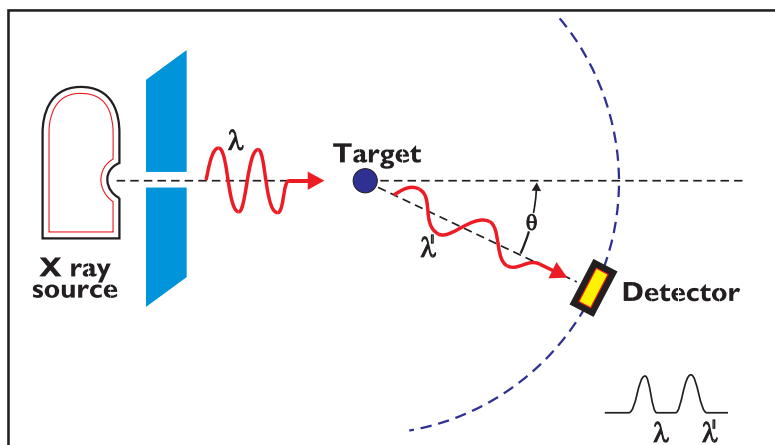

Fig: 16.8: **Niels Bohr (1885-1962)** gave a successful quantum theory of hydrogen spectrum in 1913 and guided the course of the conceptual revolution that culminated in modern quantum mechanics shaped by some half a dozen outstanding physicists: Heisenberg, Schrodinger Jordan, Born, Dirac and Pauli.



Fig: 16.9: **Werner Karl Heisenberg (1901- 1976)** was only 24 years when he published his theory of quantum mechanics in 1925. The theory proposed that mechanical quantities, such as position, velocity, etc. should be represented, not by ordinary numbers, but by abstract mathematical structures called "matrices" and he formulated his new theory in terms of matrix equations. His theory was based only on what can be observed (frequencies and intensities of spectral lines of the radiation emitted by the atom).



Fig: 16.10: A galaxy of physicists at the fifth Solvay Conference at Brussels including such celebrities as Wolfgang Pauli, Werner Heisenberg, Niels Bohr, Max Planck, Marie Curie and Albert Einstein.



Fig: 16.11: **James Chadwick (1891-1974)** proved the existence of neutrons, elementary particles devoid of any electrical charge, in the nucleus of an atom. He was awarded the Nobel Prize for Physics in 1935. Also shown in the picture is the apparatus built by Chadwick for detecting neutrons.



Fig: 16.12: **The first 'atomic pile' built by Enrico Fermi (1901-1954) and his team at the University of Chicago.** The first nuclear fission chain reaction was made possible on December 2, 1942. The achievement was a precursor to the development of both nuclear reactors and nuclear weapons.



Fig: 16.13: **The Cloud Chamber**, invented by Charles Wilson (1969-1959), has a glass chamber which contains air and super saturated water vapour. When particles knock electrons out of the atoms in the air, ions are produced. Water vapour condenses on the ions because of a sudden decrease in the pressure, forming trails of small drops.

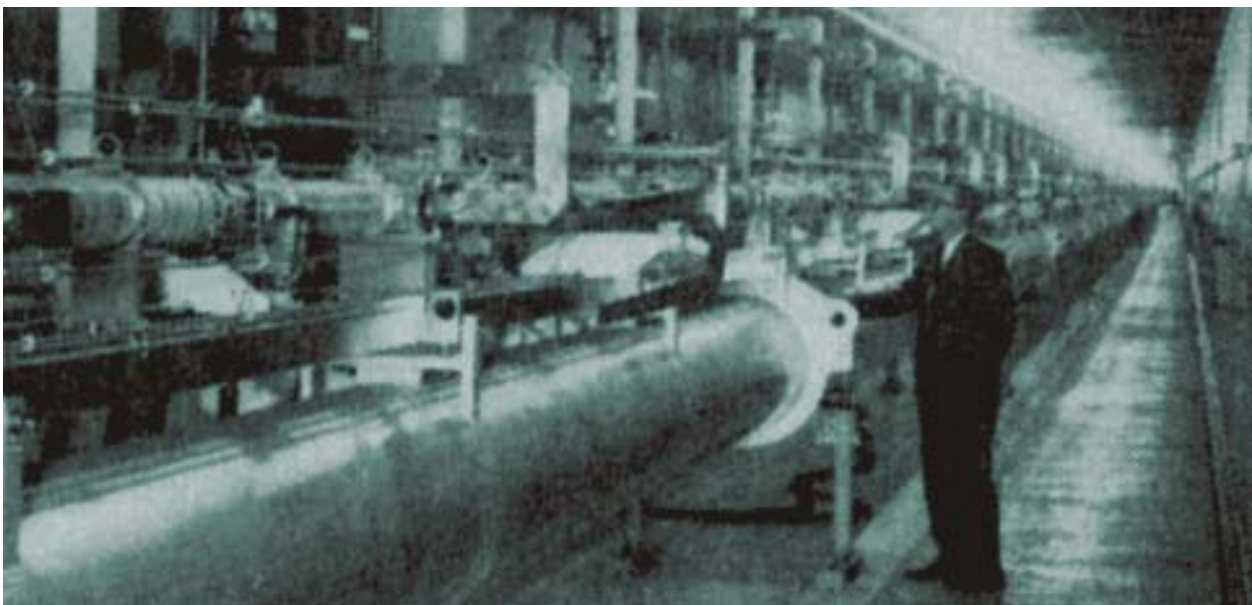

Fig: 16.14: **Erwin Schrödinger (1887-1961)** developed 'wave mechanics' of particles by considering the distribution of 'electron waves' around the nucleus. Schrödinger equation is the basic law of quantum mechanics.

Fig: 16.15: **Strange Particles**: A bubble-chamber photograph of elementary particle events. A negative pion hits a proton producing two neutral particles of opposite 'strangeness': lambda and neutral kaon. The particles reveal their presence through subsequent decays. The lambda decays to a proton and a negative pion, and the kaon decays to a pair of positive and negative pions. Other tracks seen are not relevant to the process.



Fig: 16.16: **The Stanford Linear Accelerator (SLAC)**: In the three km long vacuum pipe, electrons are accelerated to an energy of 20 GeV that brings them close to the speed of light.





Physics at small distance and high energy required a combination of quantum theory and relativity. Out of this wedlock was born the most sophisticated theory known to science: quantum field theory. Its version dealing with the interaction of electrons and photons (quantum electrodynamics) agreed with experiments to mind-boggling accuracy. Quantum field theory became a vehicle for the basic drive of twentieth century physics: unification of the fundamental forces of nature. The electromagnetic and weak interactions were subsumed under a single framework, and this success spurred heroic attempts to unify the remaining forces including gravity into one superforce. The crowning glory of experimental high energy physics was in unravelling the quark constitution of baryons and mesons and in identifying the basic constituents of matter: quarks and leptons.

Twentieth century physics made rapid strides in exploring the ramifications of quantum physics to complex atoms, molecules and condensed matter. A new state of matter - plasma, became the subject of rapid theoretical and experimental advances. Highly coherent and intense sources of electromagnetic radiation (LASER) became a major tool for scientific and technological progress. The quantum version of statistical mechanics (quantum statistics) provided a reliable framework for explaining such exotic phenomena as low temperature superconductivity, superfluidity of helium and Bose-Einstein condensation. The physics of semiconductors was germane to the post-war technological revolution ushered in by the computer.

Despite the phenomenal progress, twentieth century closed with a sobered image of physics. The arrogant deterministic view of classical physics met its first great challenge in quantum theory. In the last decades, the discovery of deterministic chaos in non-linear systems of nature has finally laid that view to rest. The interpretative problems of quantum theory have raised deep questions on the most basic premises of physics. Yet the dream of understanding the universe in terms of a fundamental all-embracing theory continues to be pursued with unabated zeal.

Fig: 16.17: **Paul Adrien Maurice Dirac (1902-1984)** applied the relativity principle to quantum mechanics in 1928. His famous wave equation, which introduced special relativity into Schrödinger's equation, reconciled the two theories. His theory predicted the existence of anti-particles, such as positron (positive electron), and questioned the conservation of elementary particles by demonstrating the mechanics of creation and annihilation of matter.

Fig: 16.18: **Emmy Noether (1882-1935)** established the deeper mathematical connection between the symmetry in the laws of physics and the conservation laws.



Fig: 16.19: **Satyendranath Bose**'s (1894-1974) famous paper on a new derivation of Planck's law which introduced a new kind of statistics was rejected by the Philosophical Magazine. Bose sent it to Einstein, who translated it into German, added an appreciative note and got it published in the journal *Zeitschrift für Physik*. Bose's statistics had profound implications which Einstein elaborated in two later papers of his own.



Fig: 16.20: **Chandrasekhara Venkata Raman** (1888-1970) was awarded the 1930 Nobel Prize in physics for a single experimental result of striking importance. The Raman effect refers to scattering of light by molecules when the scattered light has a different frequency from the frequency of the incident light. The incident photons exchange energy with the target molecules which have discrete energy states, which causes the change in frequency of the scattered light.



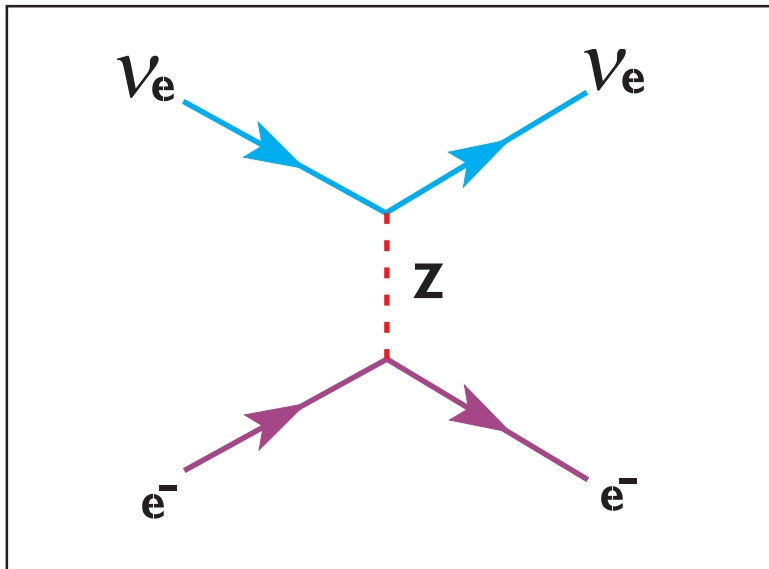

Fig: 16.21: **Forces arise through exchange of particles:** The weak nuclear interaction between electron and neutrino is mediated by a virtual Z boson. The decay of neutron to proton is mediated by charged vector \pm bosons W . The W and Z particles discovered in 1983 at CERN, Geneva with theoretically expected properties was an important landmark in particle physics.



Fig: 16.22: **Richard P. Feynman (1918-1988)** shared the 1965 Nobel Prize for his work in quantum electrodynamics.

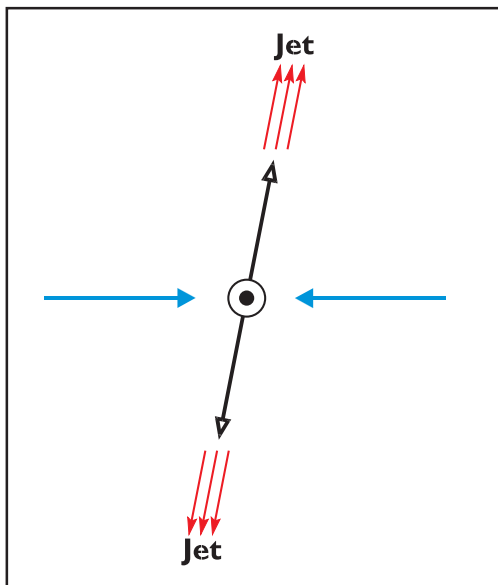

Fig: 16.23: **Two particle jets in electron-positron collisions is one indirect evidence of quarks.** The collision produces a high energy quark antiquark pair which fragments into hadrons. Many similar jets in other collisions are a growing confirmation of the existence of quarks. Physicists now believe that all matter consists of quarks and leptons. Leptons include electrons, and their other heavier counterparts.



Fig: 16.24: **Butterfly Effect:** In 1961, Edward Lorenz discovered in his model of weather that small changes in initial conditions of weather (due say to a butterfly flapping its wings) cascaded rapidly to large changes in the ensuing weather. This observation gave rise to the science of Chaos - a study of non-linear dynamical systems which are hypersensitive to initial conditions.



Fig: 16.25: **The spectacle of Superfluidity:** Below a certain temperature, liquid turns superfluid. It loses its viscosity and acts like a superconductor of heat. A heater in the glass vessel attracts superfluid helium which rushes into the vessel below the heater. The jet of liquid is forced through a small hole at the top producing a fountain.

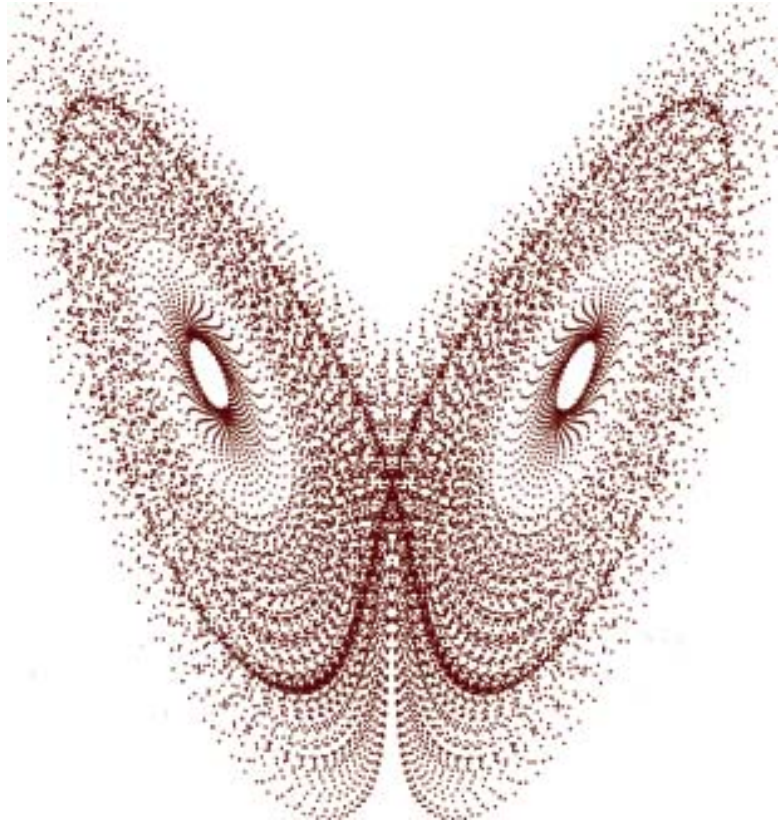

Fig: 16.26: **Strange Attractor:** The phase space trajectory of a chaotic system is a 'strange attractor' that is vastly more complex than the attractors (point, a closed loop) of ordinary systems.

Fig: 16.27: **Murray Gell-mann (1929-)**, an outstanding particle physicist, provided the basis for an understanding of hadrons (elementary particles like protons and neutrons) by inventing quarks in 1963. In the picture are two pages of the notebook, entitled *The eightfold way*.



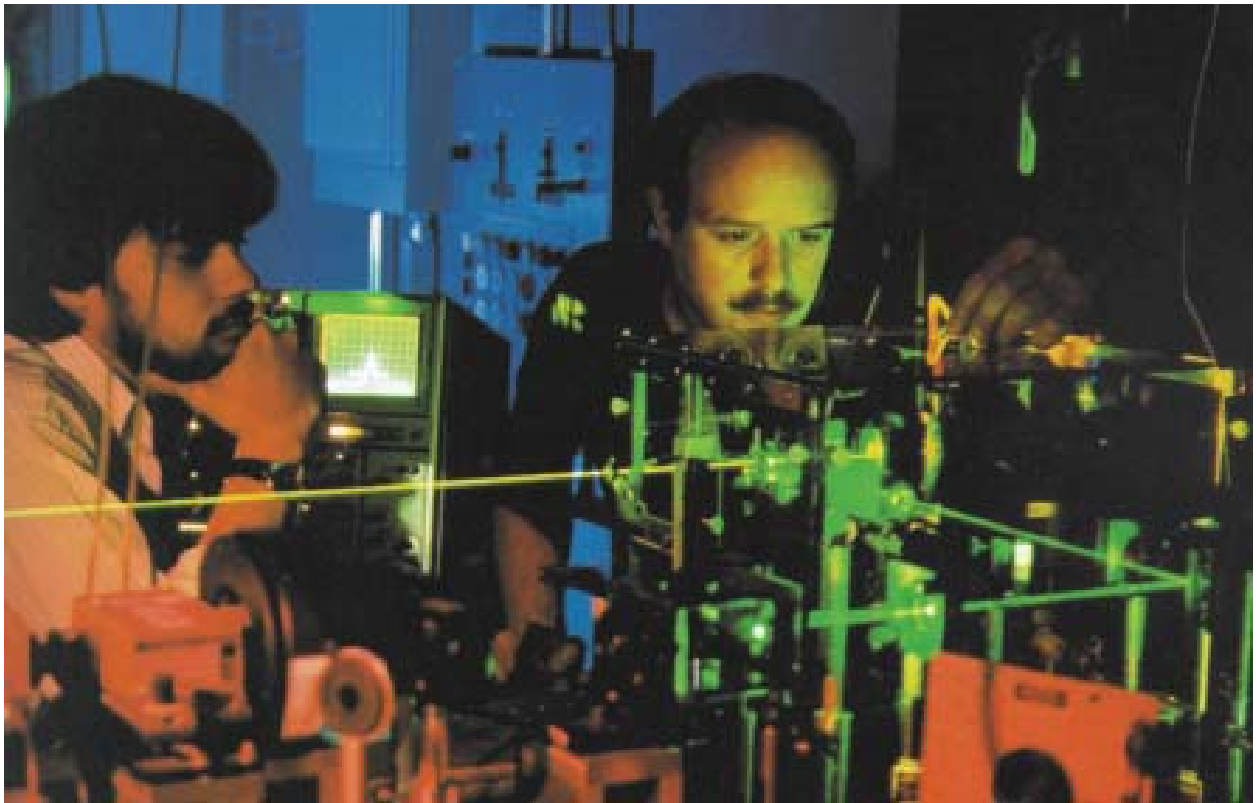
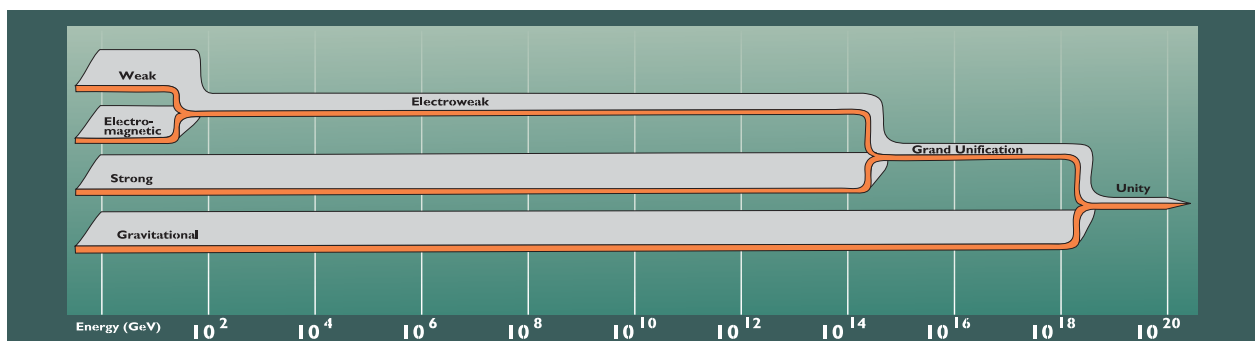

Fig: 16.28: **LASER**: Ordinary sources of light involve spontaneous emission of radiation from excited atoms and molecules. In a laser, the dominant mechanism is stimulated emission the incident photon and the radiated photon move in step.



Fig: 16.29: **Abdus Salam (1926-1979)** worked on the mathematics of the weak force (one of the four fundamental forces) along with Sheldon Glashow and Steven Weinberg. They discovered that at sufficiently high energies weak and electromagnetic interactions have similar strengths.

Fig: 16.30: **The Grand Unified theory**



17

Chemical and Materials Science

Chemical Science

The first quarter of the twentieth century witnessed important discoveries which had great impact on chemistry. Among these were the discovery of the atomic nucleus by **Ernest Rutherford**, **Niels Bohr's** (1885-1962) quantum model of hydrogen atom, modified further in 1915 by **Arnold Sommerfeld** (1868-1951), and the exclusion principle put forward by **Wolfgang Pauli** in 1925. **Henry Moseley's** (1887-1915) work on characteristic x-ray spectra of elements changed the basis of the Periodic Table from atomic weights to atomic numbers - the latter a measure of the nuclear charge of the atom. The crises of placement of nearly 30 newly discovered radioactive elements in the Periodic Table led to the concept of isotopes.

The explanation of chemical bonding in terms of electrons was put forward independently by **Gilbert N. Lewis**, **Walther Kossel** (1888-1956) and **Irving Langmuir** (1881-1957). The two important working rules of the model were the necessity of octet of electrons for stable structure, and the electron pair as the basis of atomic bonding. Lewis introduced electronic dot structure for representation of chemical bonding, whereas the term "covalent" was introduced by Langmuir. In 1923 **Nevil V. Sidgwick** introduced the concept of coordinate covalency, where the shared electron pair is donated by one of the atoms involved in bonding.

Fig: 17.1: **Sir William Ramsay (1852-1916)**, a British chemist who received the Nobel Prize in Chemistry for his discovery of a number of noble gases (a group of chemically unreactive elements). The discoveries of argon, helium, neon, krypton, xenon are credited to him. Helium was earlier identified in the solar spectrum.



Among the pioneers in applying quantum theory to molecular structure was **Linus Pauling** (1901-94). In the early thirties, Pauling introduced the notion of electronegativity for understanding partially ionic and covalent character of chemical bonds. Another novel concept, that of 'resonance', was important for understanding systems of bonds that were alternately double and single (for example, benzene). The concept of bonding also triggered the study of classes of compounds such as co-ordination compounds, chelates (compounds important in biology) and clathrates (cage like compounds). Transuranic elements were discovered and synthesized

Fig: 17.2: The apparatus, devised by Ramsay, could absorb all the known gases from atmospheric "nitrogen". The remnant gas, when examined with a spectroscopic, showed new spectral lines. This led to the discovery of a new element: argon.





Fig: 17.3: **William Henry Bragg** (1862-1942) and **William Lawrence Bragg** (1890-1971) pioneered the technique of x-ray diffraction for the study of structures of crystalline solids. An example of the power which this technique has acquired today, is the work of Perutz on the structure of haemoglobin and Kendrew on the structure of myoglobin for which they shared the Nobel Prize in Chemistry in 1962.

during the 1940's and 1950's. Physical chemistry also saw important advances in solution chemistry. **Johannes Nicolaus Bronsted** (1879-1947) and **Thomas Martin Lowry** (1874-1936) modified **Svante Arrhenius'** (1859- 1927) concept of acids and bases, regarding acids as proton donors and bases as proton acceptors. Lewis, in 1938, put forward a broader definition using electron acceptors or donors as the basis for the classification.

In the field of organic chemistry, theories of bonding provided a better understanding of reactive centres in organic compounds, the mechanisms of reactions, and effects of catalysts and solvents. New instrumentation techniques spurred progress in the synthesis and structural determination of various organic compounds, especially after the 1940's. Further, organic chemists' interest in carbohydrates, proteins and fats; drug industries' interest in antibiotics, hormones and alkaloids; and biochemists' interest in vitamins and enzymes, led to a boost in the synthesis of various substances. Examples include the synthesis of morphine by **Marshall D. Gates** and **Gilg Tshudi**, folic acid by **Coy Waller**, and insulin by **Frederick Sanger**.



Fig: 17.5: **N. V. Sidgwick** (1873 - 1952) introduced the concept of coordinate covalency, important for explaining bonding in many inorganic and organic compounds.

Fig: 17.4: **Frederick Soddy** (1877-1956) and Ernest Rutherford put forward the theory of radioactive disintegration and also proposed two radioactive decay series, namely, the uranium and thorium series with element lead as the end product. For the study of radioactive substances and the concept of isotopes, Soddy received the Nobel Prize in Chemistry in 1921.



Fig: 17.6 : **The Mass Spectrometer** is an important instrument for modern chemical analysis and research, which helps in the identification and structural determination of compounds. Spectroscopic techniques are no longer confined to the visible part of the electromagnetic spectrum. Today, ultraviolet, infrared, NMR, mass spectroscopy and Raman spectroscopic techniques are routinely used in structural, qualitative and quantitative analysis of chemical compounds.

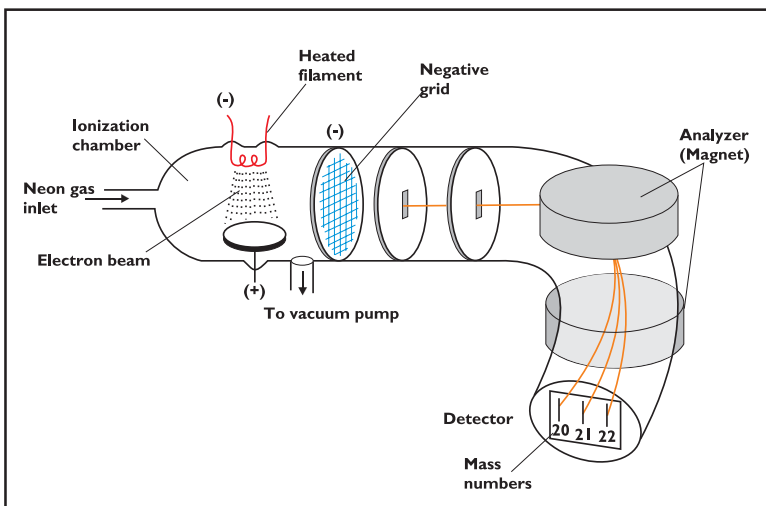

Fig: 17.7: Schematic of a Mass Spectrometer

Fig: 17.8: **Otto Hahn (1879 - 1968)** won the Nobel Prize in Chemistry (1944) for the discovery of Nuclear Fission. This led in due course to the development of nuclear reactors and atomic bombs.



Fig: 17.9: **Wolfgang Pauli (1900 - 1958)** got the Nobel Prize in Physics in 1945 for his 'exclusion principle', which explained the occupancy of electrons in various orbitals. Pauli also correctly surmised the existence of a new particle (neutrino) from his analysis of b-decay energetics.



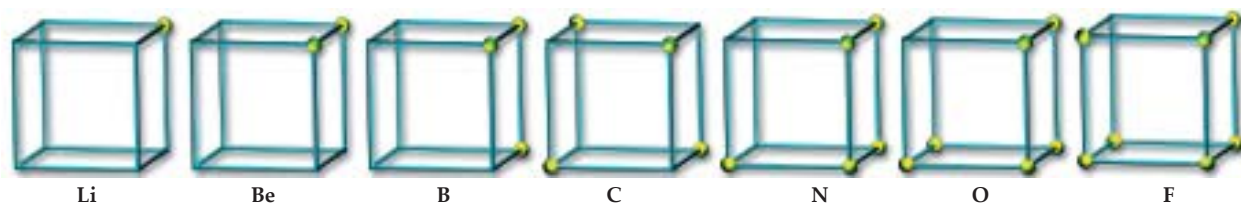

Fig: 17.10: Lewis models of the elements of the second period



Fig: 17.11: **Gilbert Newton Lewis (1875-1946)** made important contributions to the theory of chemical bonding and the concept of acids and bases. He also introduced the electronic dot structure notation for representation of chemical bonding.



Fig: 17.12: **Linus Carl Pauling (1901-94)**, was a towering figure in twentieth century chemistry. His book *The Nature of the Chemical Bond* has influenced generations of chemists after it was published in 1939.

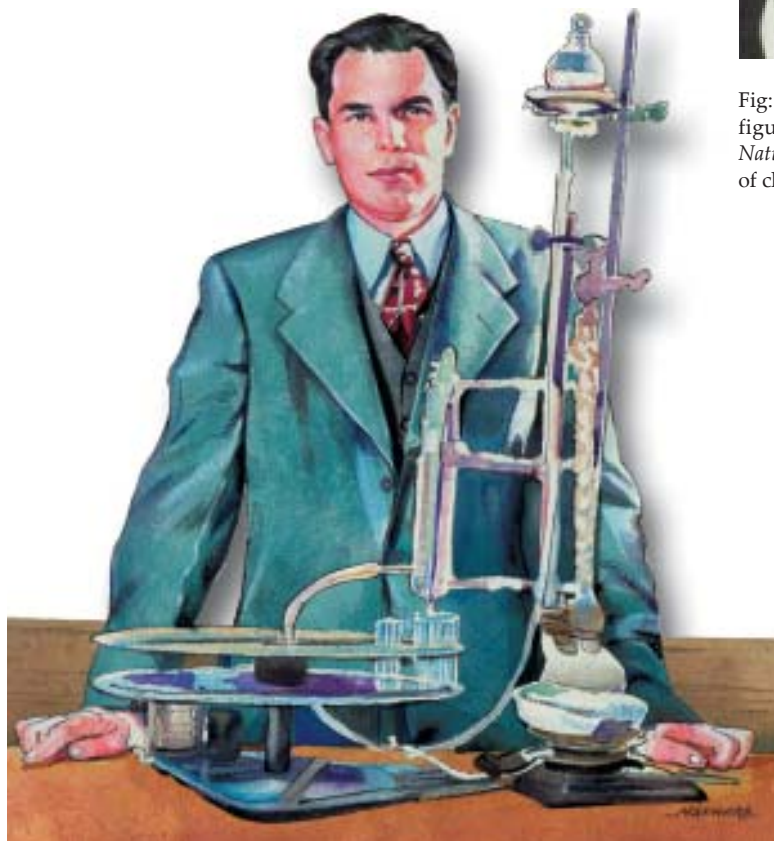

Fig: 17.13: **Glenn Theodore Seaborg (1912-99)** received the 1951 Nobel Prize in Chemistry for his discovery of several transuranic elements. He was a prolific writer on chemistry and its history.



Fig: 17.14: **Dorothy Hodgkins (1910-1994)** made a series of brilliant breakthroughs in science. Using x-ray crystallography, she deciphered the atomic structures of penicillin, vitamin B12, and insulin. She has been called “the cleverest woman in England” and “a gentle genius”.

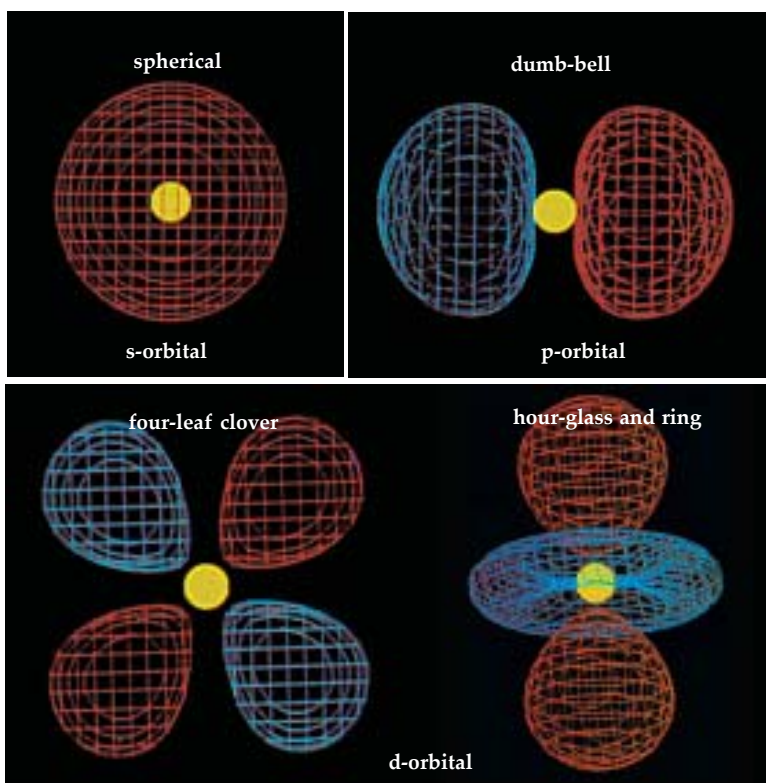

Fig: 17.15: Computer simulations displaying shapes of s, p and d atomic orbitals based on the modern quantum theory

Materials Science

A chronological account of discoveries and inventions that have led to a revolution in materials during the twentieth century could fill tomes. Yet, it is possible to trace much of the progress in this field to a few outstanding innovations. Important among them are the first laboratory synthesis of a dye, the theory of polymerization and the commercialization of synthetic plastics. Understanding the relationships between composition, structure and property, at the atomic and molecular level, has been a salient feature of research in the 20th century. It has brought together scientists from physics, chemistry, biology, metallurgy and the earth sciences. Many needs of the burgeoning population have spurred this trend: food, shelter and medicine, efficient use of resources and reserves, materials for

Fig: 17.16: **Charles Goodyear (1800-1860)**, an American inventor, discovered the vulcanizing process when some rubber mixed with sulfur accidentally dropped on a hot stove. Prior to this, rubber was too adhesive and unable to withstand temperature extremes.



Fig: 17.17: Manufacture of synthetic rubber in the wake of World War II replaced natural rubber.



high technology applications and explorations in space, and energy. Polymers in countless incarnations, chemicals of every hue, taste and smell, semi-conductors, synthetic diamonds, the 60-carbon buckyballs, nanotubes, conducting polymers, superconductors, quasicrystals and ceramics have all spawned whole branches of scientific enquiry.

Leo Hendrik Baekeland was an American industrial chemist who helped found the modern plastics industry through the invention of bakelite, the first thermosetting plastics – plastics that do not soften on heating. This is the forerunner of the plastics of this century that satisfy exacting requirements: they perform at high and low temperatures, are stronger than steel, lighter than feather, and come in attractive colours. In 1856, **William Perkin** (1838-1907), an 18 year old British chemist, discovered through a combination of accident and sagacity, the first ever synthetic dye. This purple dye, most commonly known as “mauve,” was made from toluidine, a derivative of coal tar, till then a useless byproduct of the steel industry. Perkin’s discovery, together with the stimulation provided by Kekule’s molecular architecture, spurred the development of aromatic organic chemistry in the latter half of the 19th century, especially in Germany. Many of the early synthetic dyes were aromatic compounds related to benzene. The commercial success of mauve heralded the birth of synthetic dyestuffs industry.



Fig: 17.18: Belgian-born American chemist **Leo Baekeland (1863-1944)** made Bakelite, first with the ‘steam-heated still’ in a laboratory and commercialized it. The picture below shows some Bakelite products.

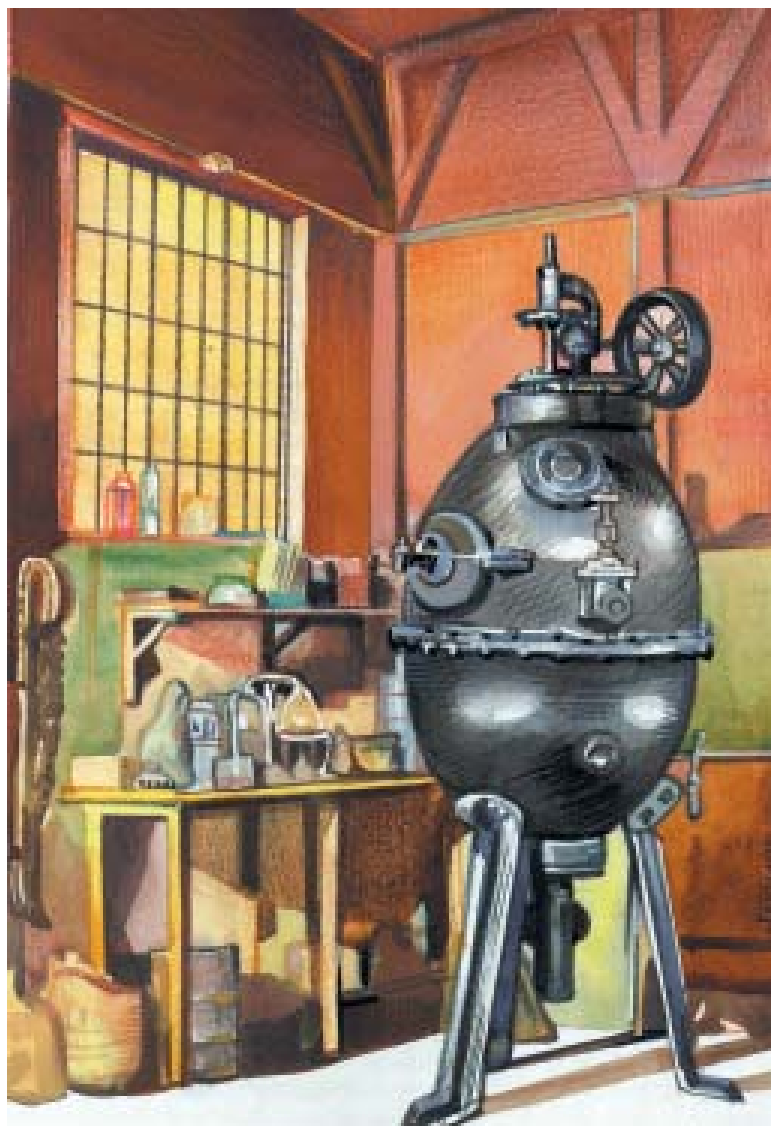

Fig: 17.19: Leo Baekeland’s laboratory



Fig: 17.20: **Nylon- 6,6** was used in World War II for parachutes and tough fabric requirements. It then became a symbol of postwar fashion, as in the silken, tear-resistant, highly elastic synthetic stockings.



Fig: 17.21: **Wallace Hume Carothers (1896-1937)**, father of the synthetic fibre industry, developed the theory of condensation polymerization.



Fig: 17.22: **Walter Reppe (1892-1969)** explains Polyvinyl pyrrolidone synthesis, a substitute for blood plasma used in many medical applications. The reactions he discovered allowed synthesis of versatile precursors from simple building blocks.



Fig: 17.23: Carl Bosch (1874-1940) and Fritz Haber (1868-1934)



Fig: 17.24: **Haber-Bosch process** heralded a new era in the chemical industry. Ammonia was synthesised from air in the laboratory by Nobel Laureate (1918) Fritz Haber and in a high pressure reactor by Nobel Laureate (1931) Carl Bosch.



Fig: 17.25: **Joseph Aspdin (1779-1855)** of England invented the standardized manufacture of cement by burning finely ground chalk with finely divided clay in a lime kiln until carbon dioxide was driven off. The sintered product was then ground and called Portland cement after the high quality building stones quarried at Portland, England.

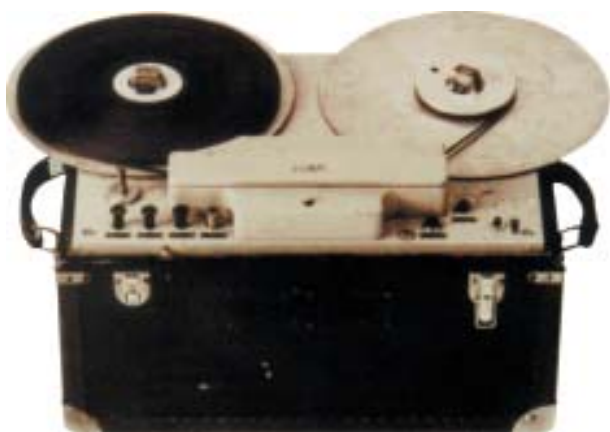

Fig: 17.26: First magnetic tape and tape recorder made in 1934, through a cooperative venture between a giant chemical conglomerate (I. G. Farben) and a large electrical company (AEG). The information recording magnetizable material has changed over the years, from carbonyl iron powder, then iron oxide to finely dispersed needle-shaped chromium dioxide in the 1970s. Particles are embedded in binders, coated on polyester films, cut into required widths and automatically spooled into cassettes.

Fig: 17.27: Microscopic view of groups of crystals which chemists use to study polymer structure

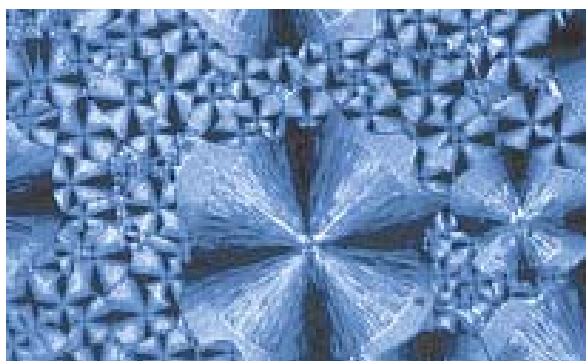
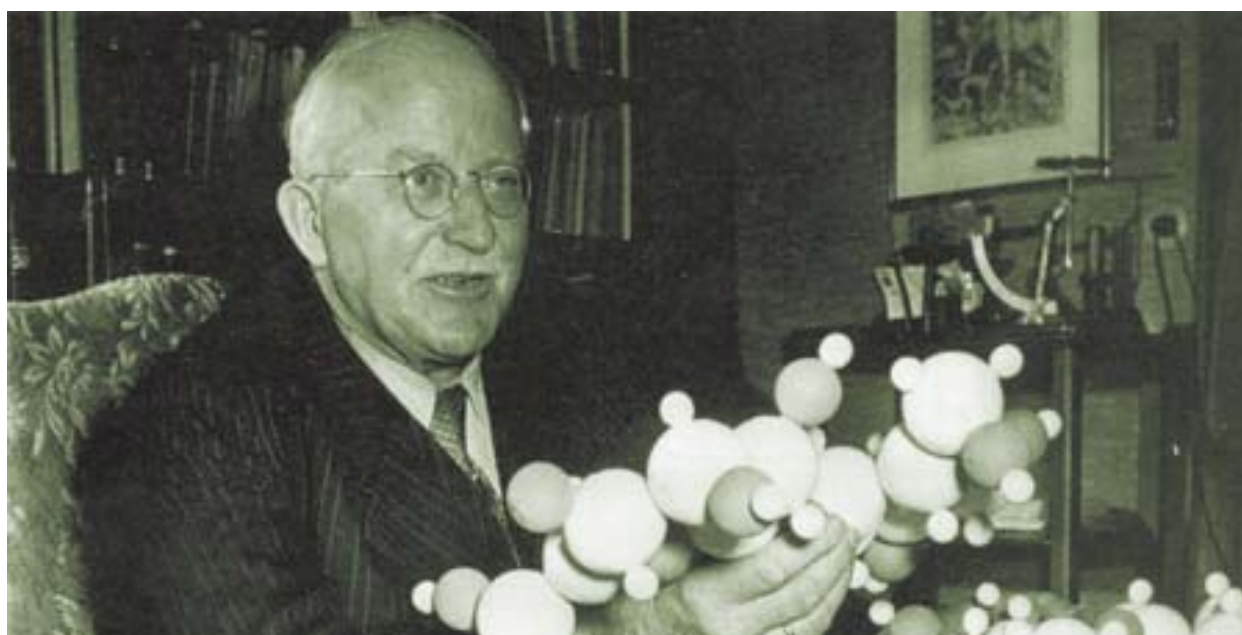

Fig: 17.28: Highly concentrated pigments which colour whatever they are mixed with are used for making emulsions, paints and coatings.

Fig: 17.29: **Hermann Staudinger (1881-1965)**, a German chemist, put forward the concept of macromolecules in 1926, by synthesizing many polymers. The large plastics industry is based on Staudinger's work. His work on polymerization was recognized by a Nobel Prize in 1953.



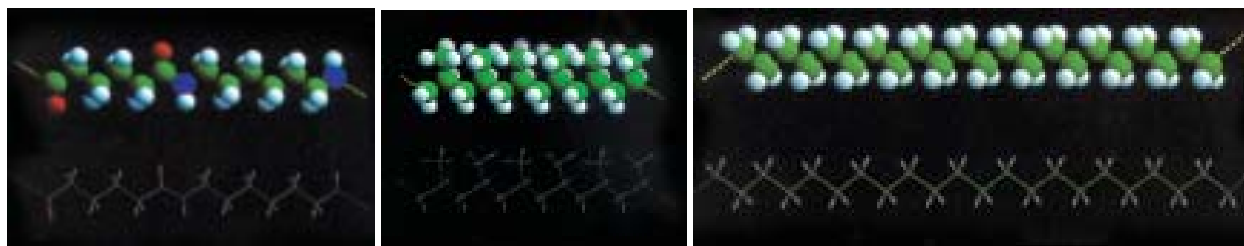

Fig: 17.30:

Johann Friedrich Wilhelm Adolf von Baeyer (1835-1917), who won the Nobel Prize in 1905 for his discovery of a group of dyes called 'phthaleins' and was the first to synthesise indigo, used the Perkin Reaction in one of his trials. The successful sale of inexpensive indigo synthesised from naphthalene in 1897 was a milestone in the history of dyestuffs, that caused cultural and economic upheavals across the globe. It led to the famous Champaran movement in Bihar, India, in the early twentieth century, when the local people who subsisted on growing indigo plants for use in Britain, were deprived of their livelihood. Since 1950, through the cross fertilization of ideas in physics, chemistry and biology, scientists have been able to use some of the special properties of dyestuffs in a large variety of high technology applications, like information recording and display media, solar batteries, nonlinear optics, dye lasers, probes in medical and biotechnology applications, and photodynamic therapy of cancer.

The dyestuffs industry has been the mother of all chemical industries. Pharmaceutical drugs were discovered either in these industries, or in the process of studying dyes for other applications. Agrochemicals, polymers, fibres, textiles, plastics, vitamins, flavours and fragrances, have all derived, some more directly than others, from the dyestuffs industry.

Dr. Wallace Hume Carothers, a chemistry instructor from Harvard, joined **DuPont** on February 6, 1928. His review, simply titled "Polymerization," published in *Chemical Reviews* in 1931, offered a new vocabulary with the now familiar terms. It set scientists the world over thinking about polymers and their expected properties. He brought into his group **Dr. Paul John Flory** (1910-85), who under Carothers went on to win the Nobel Prize in 1974, for his seminal work on molecular weight distribution.



Fig: 17.31: **Superconductors**, awaiting a technological breakthrough for wide- scale applications. A bar magnet lowered onto a superconducting tin dish creates a magnetic image in the dish, and is therefore repelled by the force between like poles, so that it remains levitated above the dish.

Fig: 17.32: **Detergent** action is a current area of research, while synthetic detergents flood the market in many forms.

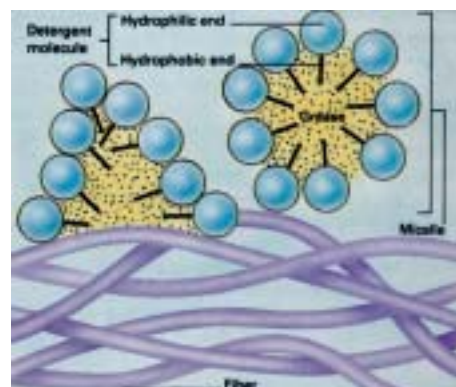



Fig: 17.33: **A Cool Kitten:** Perched on top of a 2,000 degrees Celsius. flame, this kitten is protected by a slab of silicone called RTV 615, a transparent rubber. Similar silicones, called the space-age substances, are used as heat shields of space vehicles and can withstand the temperatures of 8,000 degrees Celsius.

Nylon-6,6, the result of Carothers' early observations, transformed DuPont company from a 'merchant of death', making explosives and "agent orange" to the industrial chemical and fibre giant of the 1950s and beyond. Carothers, however, did not live to see the commercialization of Nylon-6,6 in 1939. The history of commercialization of fibres starts with the semisynthetic rayons in the beginning of this century and includes cellulose acetate, glass fibres, aliphatic nylons, polyesters, acrylics and modacrylics, polypropylene, aromatic polyamides and biomaterials for sutures. Fragrances, insect repellants, and deodorants are added to the core of the fibres that have sheaths with desirable physical properties like abrasion resistance. Materials have been successfully tailored with an incredible range of properties; myriad of colours and sparkling whites that satisfy our aesthetic needs, and products which span the realms from the exotic to the mundane and life-saving. Considering the present capability to design and synthesise molecules and materials of any desired property, the materials of tomorrow will be dictated by human needs and spurred by human imagination.

Prophesied by Richard Feynman in his famous reference to the prospect of miniaturisation, "There's plenty of room at the bottom," miniature materials have now reached atomic dimensions. There has been a flurry of activity in this field at the turn of the century aided by the invention of techniques to manipulate individual atoms, discovery of buckyballs and carbon nanotubes, and research on DNA computing and molecular switches. The application possibilities of this new field of "nanotechnology" are mind-boggling.



Fig: 17.34: **Leather** of any colour, and hides of every hue are made using polymer dispersions. India is one of the world's leading exporters of leather.

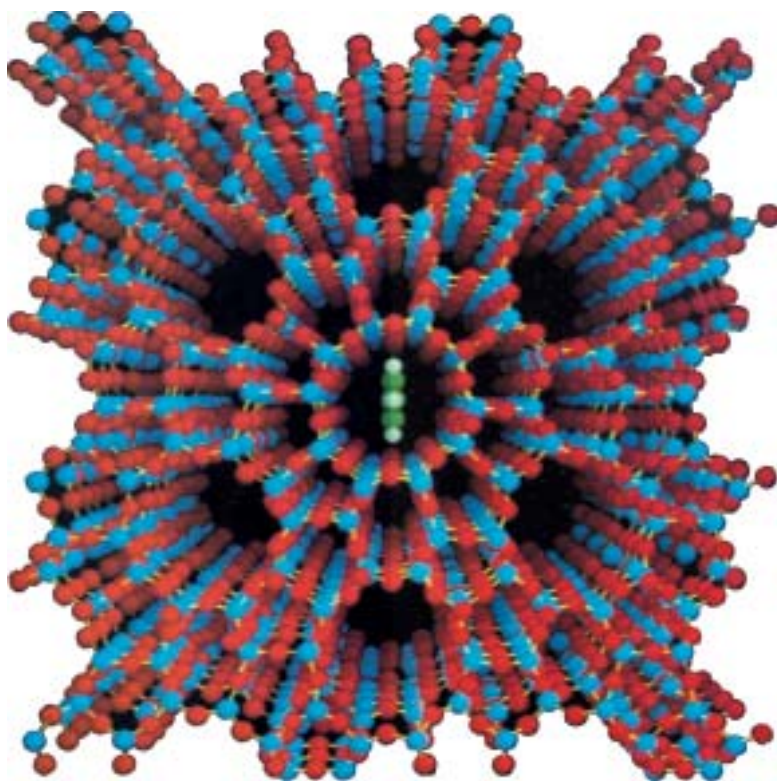

Fig: 17.36: **Zeolites**, the most amazing catalysts, aid a variety of chemical processes – from oil extraction to polymer synthesis.

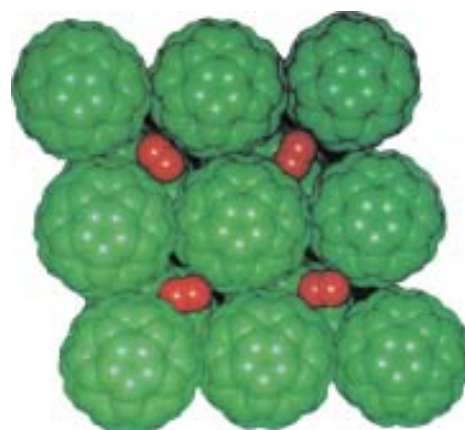

Fig: 17.35: **Fullerenes**, are the third allotropic form of carbon. Buckyball or Buckminster fullerene, is a 60-carbon football-shaped molecule with many potential applications. Graphite and diamond are the other two well-known forms of carbon.

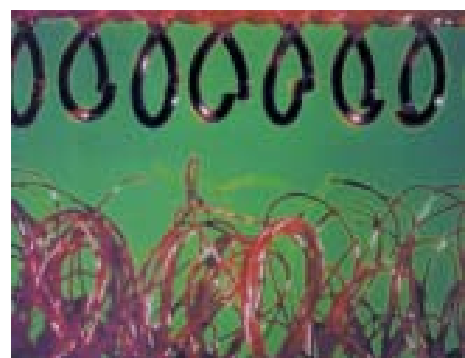

Fig: 17.37: **Optical fibres**, which have revolutionised communications technology, are so thin that a whole bundle of fibres can pass through the eye of a needle.

Fig: 17.38: **Pieces of plastics**: spares for a variety of human organs, like capillaries and heart.



Fig: 17.39: **Sticky polymers**: Surfaces are made sticky using entwined plastics fibres or synthetic glue. A close-up view of velcro surfaces.



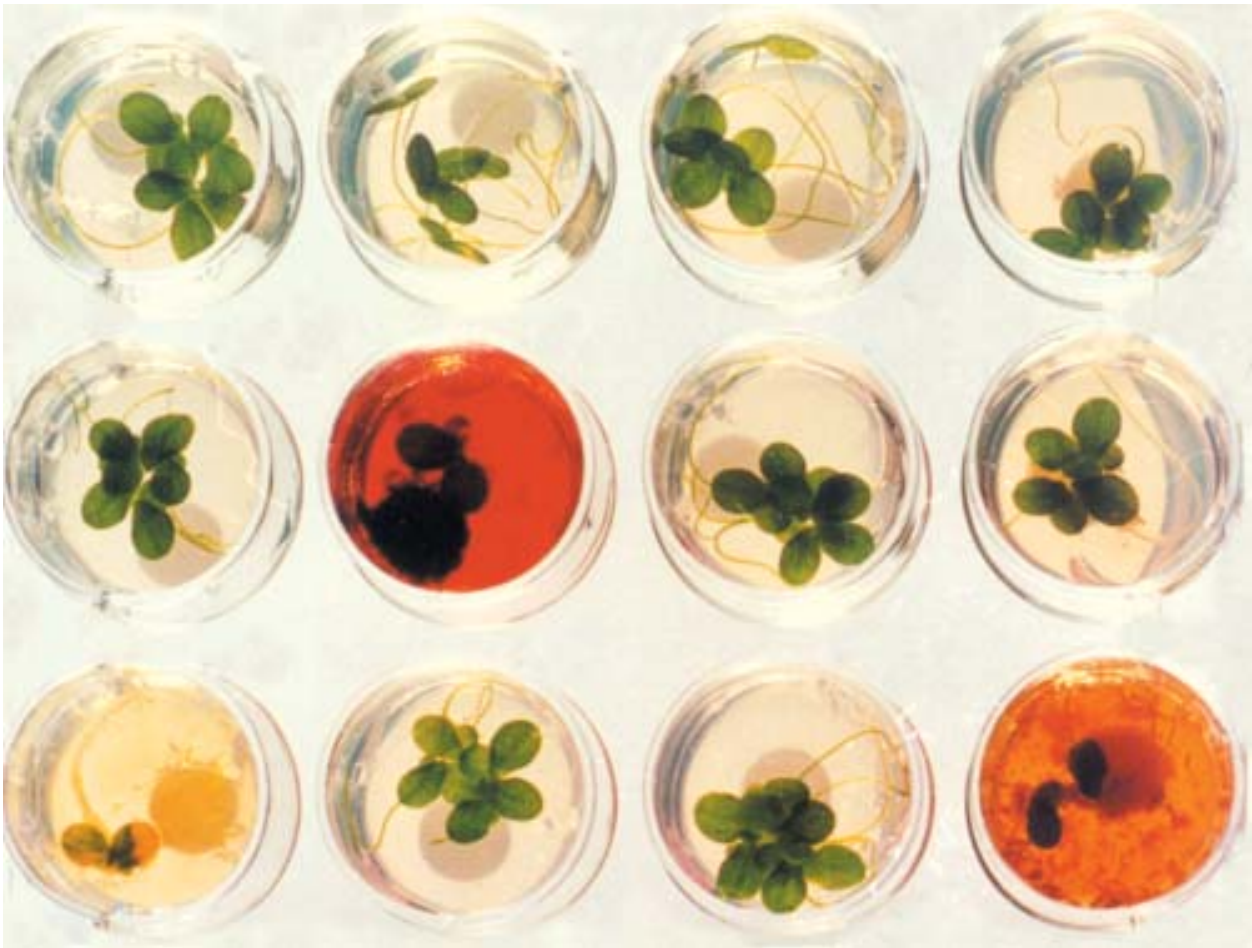

Fig: 17.40: Crop protection possible through large scale application of genetic engineering.

Fig: 17.41: **House of Plastics:** The walls, floors, roof and everything within are made of synthetic plastics. Even lawns and pavements are available in plastics.



Fig: 17.42: There are many kinds of plastics — polyolefins for films and containers, polystyrenes for electrical, construction and packaging industries (styrofoam), polyvinyl chloride for floor covering, doors, polyurethanes, versatile plastics used in refrigerator insulation, and engineering plastics, like nylons, advanced composites in modern transportation systems, and geotextiles.





Fig: 17.43: Oil and Natural Gas are the basic feedstocks for Chemicals and derived products - colorants, pharmaceuticals, agrochemicals, cosmetics, perfumes, polymers and bio-materials.



Fig: 17.44: **Technology on the horizon:** Chemicals and modern instrumentation are used in making solar cells. Electricity also flows through the conducting film of plastics to light a bulb.

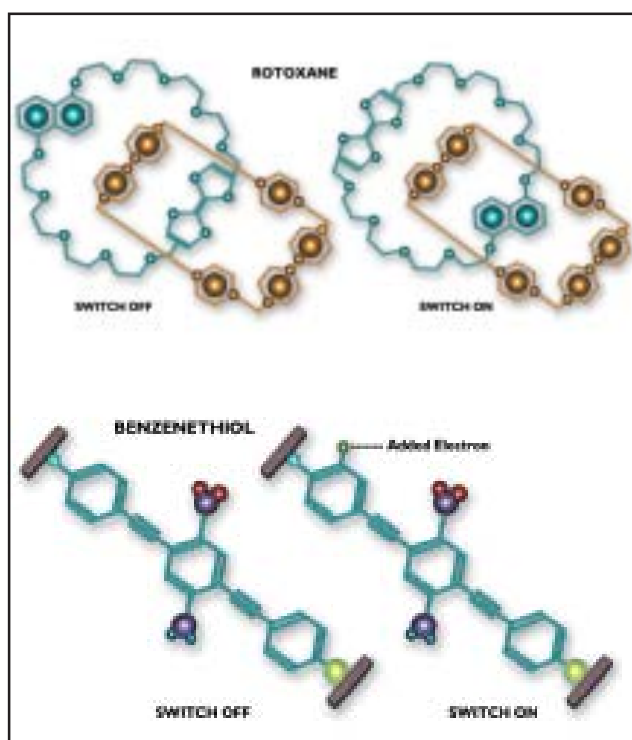
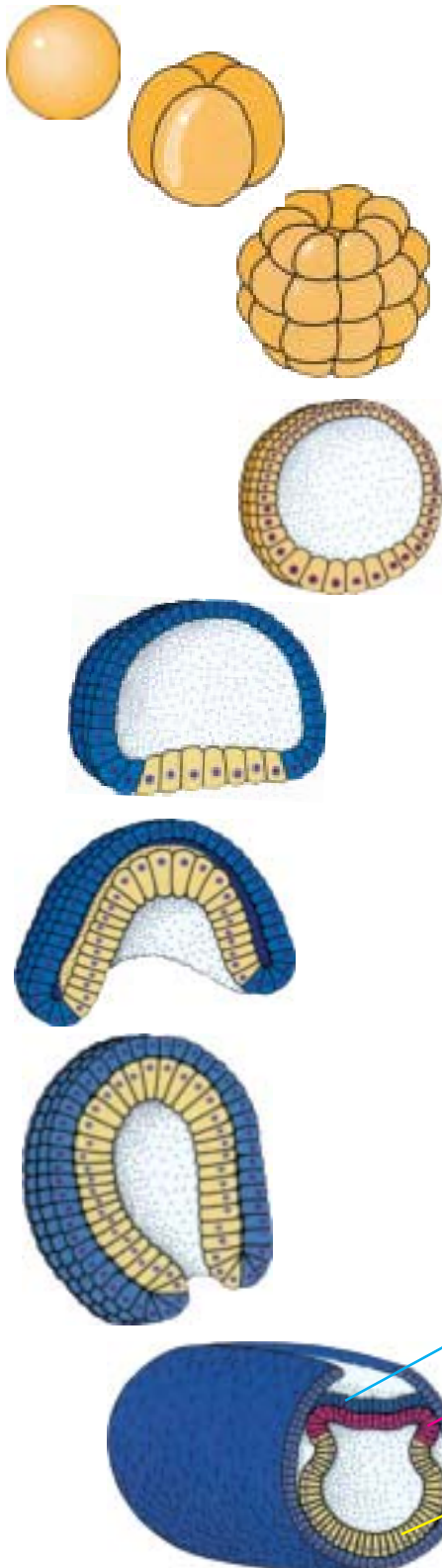

Fig: 17.45: Towards molecular transistors: Organic molecules act as switches that "turn on" and allow current flow when a chemical reaction alters their atomic configuration.

18

Progress in Biological thought



Physiology underwent a widespread change with the introduction of physicochemical and experimental methods supplemented by detailed microscopic and anatomical descriptions. Broadly speaking, the physiological research was carried out with two distinct philosophical approaches: mechanistic and holistic. **Jacques Loeb** (1859-1924) championed the agenda for the mechanistic school, leading to rigorous experimentation and quantitative reasoning. Under the influence of **Francois Magendie** (1783-1855), **Claude Bernard** (1813-1878) did path breaking work in animal physiology. He suggested that the different parts of an organism work in coordination to protect it from variations in the external environment by maintaining a constant internal environment. **Walter Bradford Cannon** (1871-1942) named this constant internal state 'homeostasis' and spearheaded a holistic school in physiology. The idea of homeostasis provided a model for not only understanding the organism as an integrated complex system, but also became the basis of general systems theory, control theory and cybernetics — areas of science that have wider applications cutting across the borders of disciplines.

Neurophysiology was another significant area of progress. The versatile German scientists Galvani and Helmholtz carried out experiments indicating the electrical nature of nerve fibres. Ramon y Cajal, using Golgi's technique of staining neurons, proved in 1906 that the nervous system was actually made of neurons (nerve cells). **Charles Sherrington** discovered the special zone of intercellular

Fig: 18.1: **Early developmental biology:** One of the first major studies on the development of a chick embryo was carried out by **Casper Friedrich Wolff** (1733-1794). The deep-rooted thesis that the seed or sperm contains the preformed miniature of the adult was contrary to the observations of Wolff. He proposed the idea of gradual development of the adult from the unorganised mass. **Karl Ernst von Baer** (1792-1876), the discoverer of the mammalian egg, furthered this thesis. According to him, in the stepwise development "more special develops from more general type". He and his colleague **Christian Heinrich Pander** (1794-1865) share the credit of the discovery of "three-germ layer stage" of the embryos. All the organs in the later embryo develop from these three layers.

Embryonic Germ Layer	Vertebrate Adult Structures
Ectoderm (outer layer)	Epidermis of skin; epithelial lining of oral cavity and rectum; nervous system.
Mesoderm (middle layer)	Skeleton; muscular system; dermis of skin; cardiovascular system; excretory system; reproductive system including most epithelial linings; outer layers of respiratory and digestive systems.
Endoderm (inner layer)	Epithelial lining of digestive tract and respiratory tract; associated glands of these systems; epithelial lining of urinary bladder.

communication called the synapse. He also elucidated the relationship between the central and peripheral nervous system, reflex action, and the integrative role of the spinal cord. In 1912, the German biologist **Otto Loewi** (1873-1961) identified acetylcholine at the synapse and introduced the notion of neurotransmitters. It was clear by then that the nervous system works both by electrical and chemical means of communication.

With the developments in polymer chemistry and invention of ingenious techniques of isolation and identification of natural compounds at the beginning of the twentieth century, science began the long journey of understanding 'life' in molecular terms. **Hermann Emil Fischer** (1852-1919), in 1902, demonstrated that proteins are polypeptides. **Herman Staudinger** (1881-1965) spearheaded macromolecular chemistry, followed by the invention of ultra-centrifugation, the powerful technique of isolating macromolecules developed by **Theodor Svedberg** (1884-1971) after 1925. The catalytic role of enzymes was proved by **Wilhelm Ostwald** (1853-1932) in 1893, and their capacity to function out of living cells was demonstrated by **Eduard Buchner's** (1860-1917) work on alcoholic fermentation in 1897. Much later in 1926, **James Sumner** (1887-1955) purified, crystalized and identified enzymes as proteins. These developments paved the way for establishing the dynamics of metabolic reactions mediated by enzymes.

In parallel to these developments, the work of elucidating the steps of metabolic reactions engaged the great German scientists like **Warburg**, **Meyerhof** and **Krebs**. Hans Krebs and **K. Henselert** discovered in 1933 the first metabolic cycle, namely, the urea cycle. In the same year, the crucial steps in the breakdown of glucose were unravelled by **Gustav Embden** (1874-1933) and Otto Meyerhof (1884-1951). Building on these earlier works, Krebs worked out the citric acid cycle, the hub of all metabolic activities in the cell. His work combines brilliant reasoning with innovative design of experiments that rank among the classic investigations of science. **Melvin Calvin** (1911-97) worked out the crucial steps of photosynthesis in the 1950s using radioactive carbon isotope. In the early 1950s, **Linus Pauling** established the helical structure of protein, and suggested that the specific three-dimensional folding of protein molecules plays a decisive role in their functioning. In 1953, **Frederick Sanger** determined the amino acid sequence of the protein, insulin.

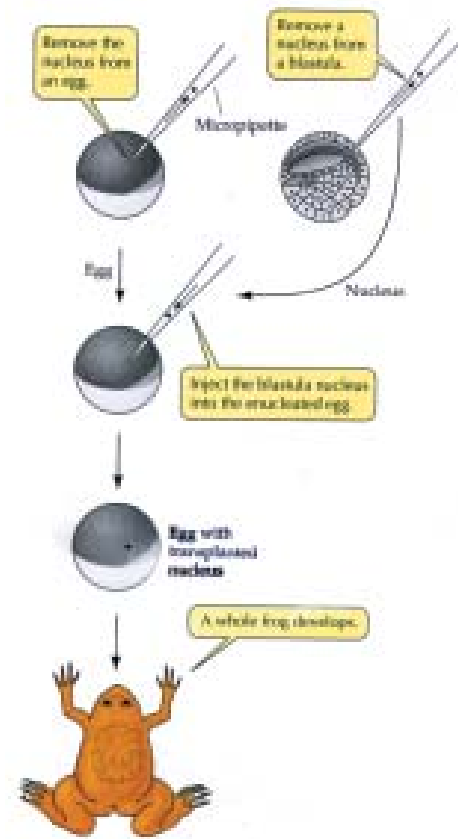
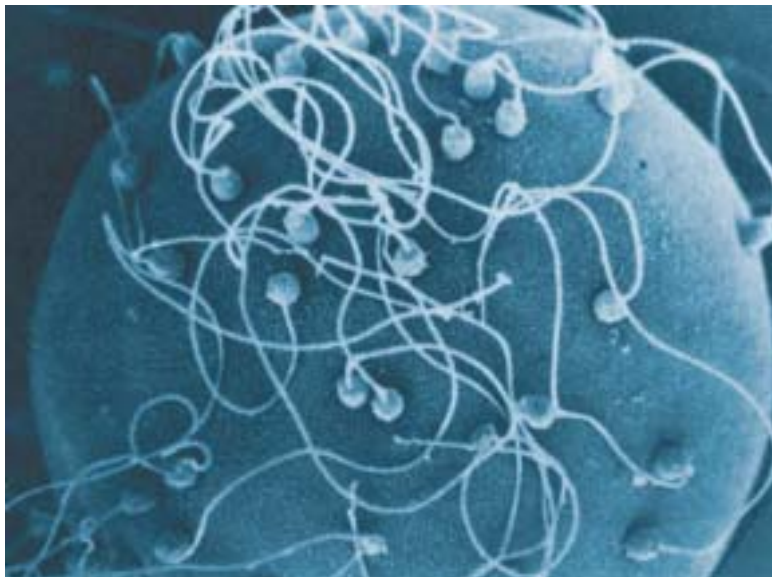

Fig: 18.2: **Robert Briggs** and **Thomas J. King** experimentally proved that a nucleus collected from the cell at a late stage of development was capable of guiding normal development when transplanted into an egg's cytoplasm. **John B. Gurdon** (1933-) repeated similar experiments in 1965, which gave rise to an understanding of how cell differentiation takes place by turning on and off of the genes during the development of an embryo.

Fig: 18.3: **George Newport's** (1802-1854) experiments demonstrated the fertilisation mechanism. The photograph shows the entry of sperm into an egg.



Fig: 18.4: Hans Krebs (1900-1981)

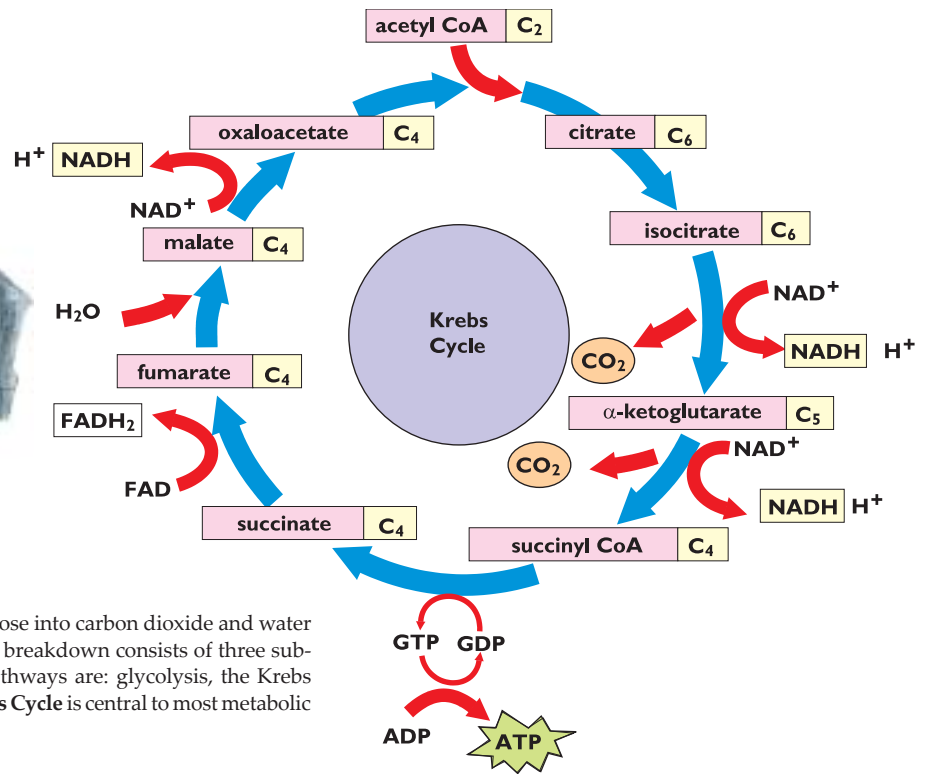

Fig: 18.5: The biochemical breakdown of glucose into carbon dioxide and water consists of a complex series of reactions. The breakdown consists of three sub-pathways and a transition system. These pathways are: glycolysis, the Krebs Cycle and the electron transport system. **Kreb's Cycle** is central to most metabolic pathways.

Fig: 18.6: Shown here are the various levels of protein folding..

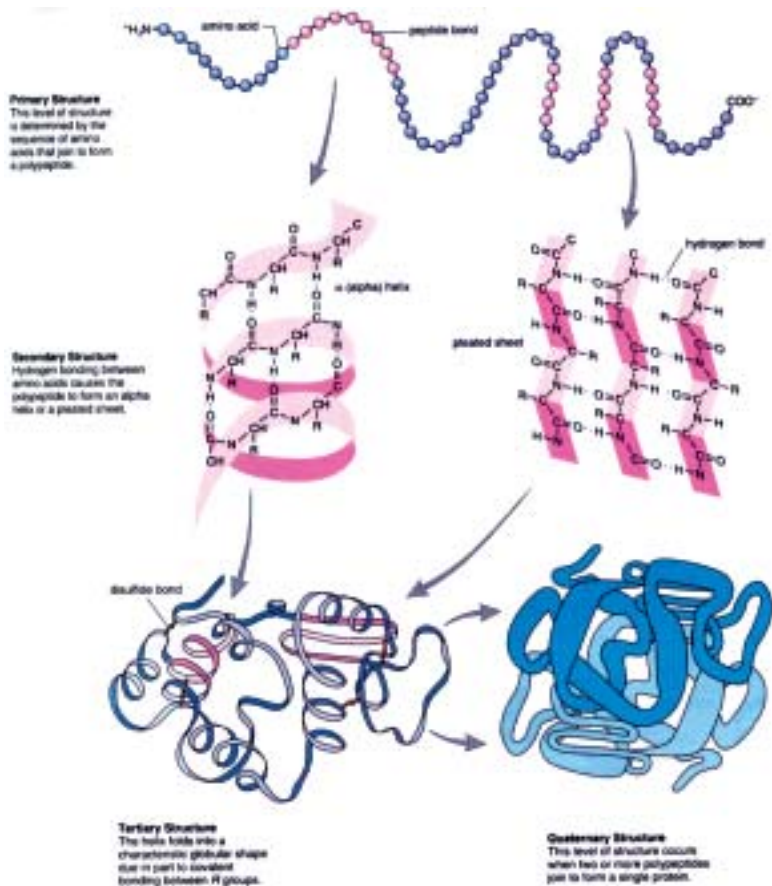

Fig: 18.7: **Linus Pauling** (1901-94), one of the most distinguished and popular biochemists of the twentieth century, unravelled the complex structure of proteins.



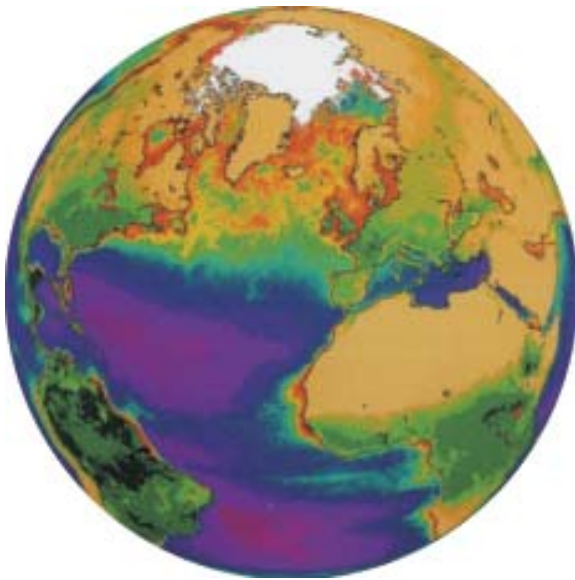

Fig: 18.8: Ecological thought has ancient origins in all cultures. The writings of **Buffon**, **Linnaeus** and **Darwin** reflect a deep ecological understanding, though it was **Ernst Haeckel** who coined the term 'ecology' in 1866. Largely static and descriptive for several decades, the concepts of cyclic changes in population, competition and the energy turnover problems revived ecology in the early years of the twentieth century. Today ecological study has acquired an immediacy in view of the fast deteriorating environment and vanishing species under the pressures of changing life styles. The concept of sustainable environment has the potential of heralding a new world order.



Fig: 18.9: ATP molecule

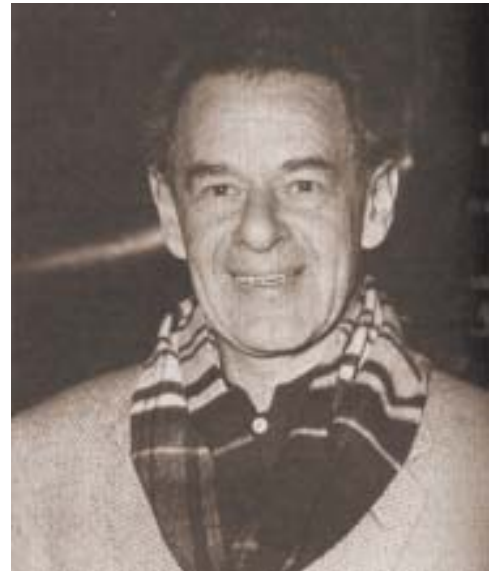

Fig: 18.10: **Fritz Albert Lipmann (1899-1986)** postulated the central role of ATP molecules in metabolic reactions.

Fig: 18.11: **Konrad Lorenz (1903-89)** inaugurated the field of ethology and focussed attention on species-specific behaviour like courtship patterns, which are genetically controlled. Newly hatched goselings and ducklings follow and become socially bonded with the first moving object. This phenomenon of "imprinting" was studied by Konrad Lorenz. The picture shows the goselings following Lorenz, considering him as their 'mother'.

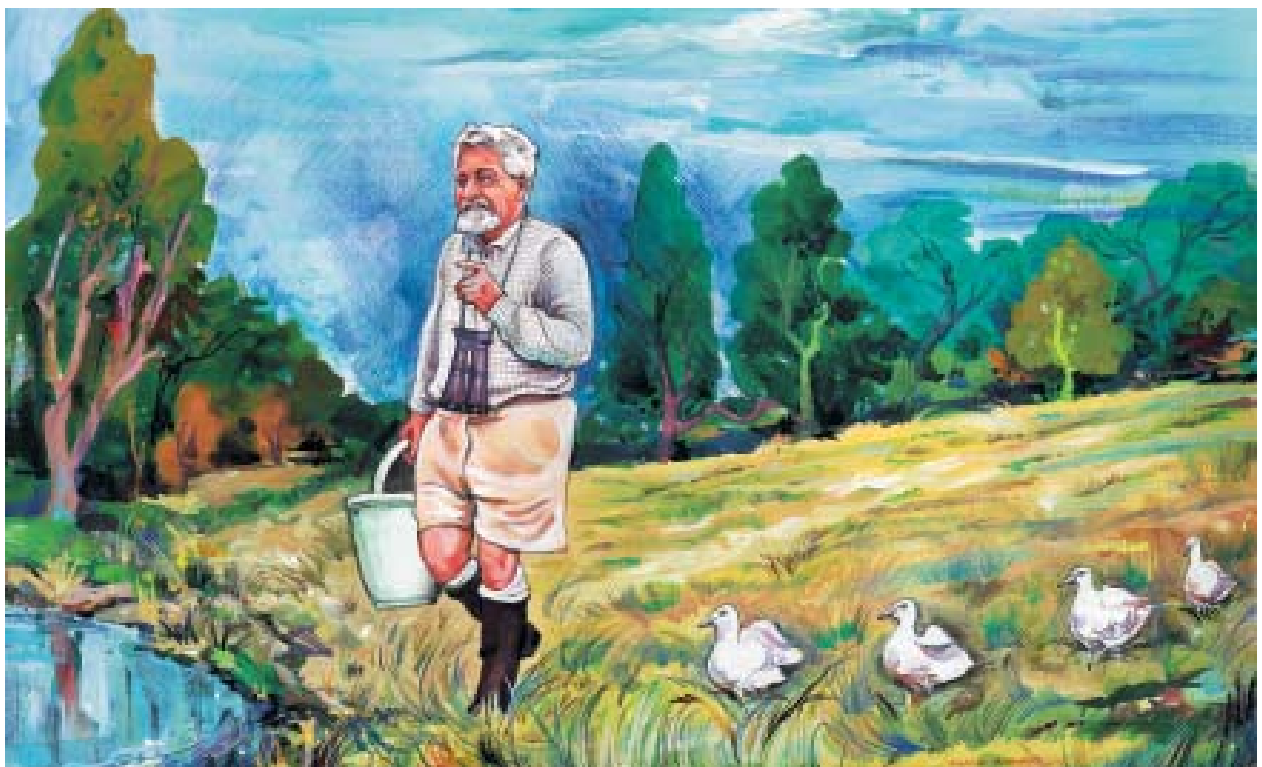



Fig: 18.12: Micrographs of a plant cell division. Microtubules (cytoskeletal protein fibers) are stained red and chromosomes are counter-stained blue

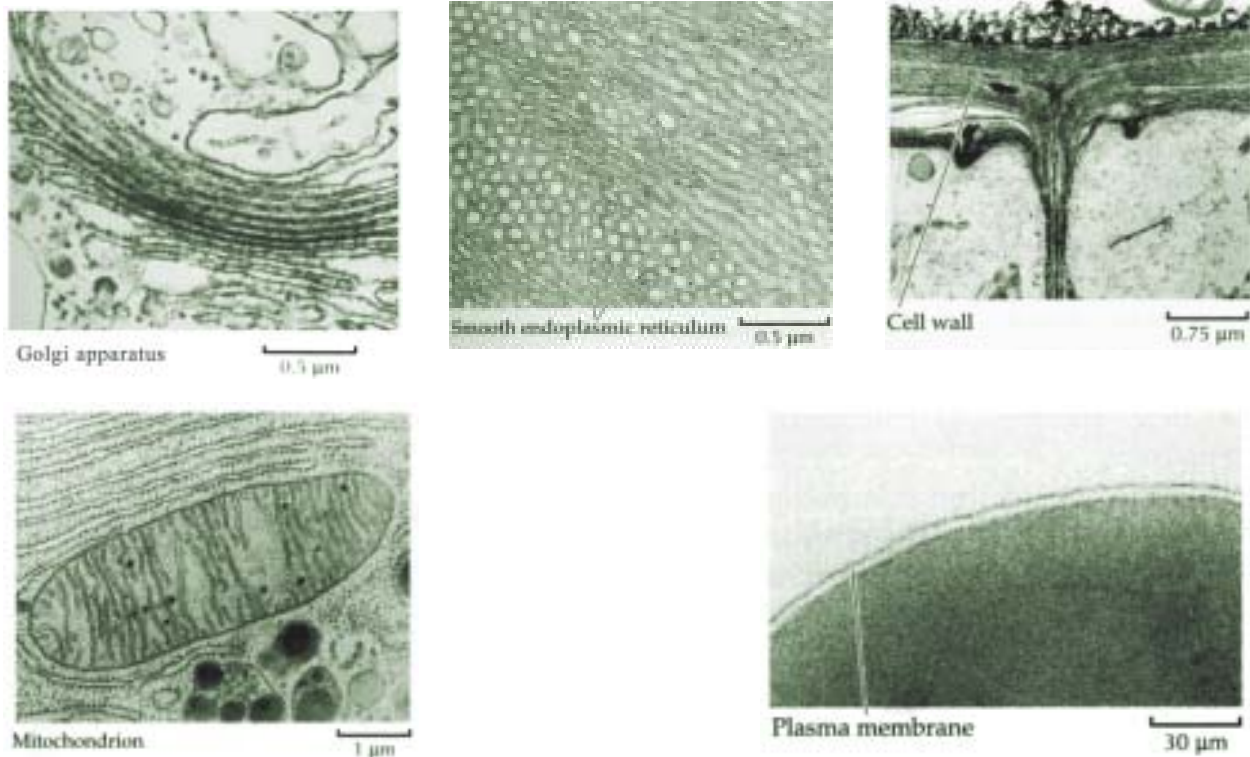

Fig: 18.13: The first electron microscopes were independently built by **Ernst Ruska (1906-88)** and **James Hillier (1915-)**. Electron microscopy revealed vividly the intricate details of the cell and cell organelles. The picture shows the structure of a plant cell with the electron micrographs.

Remarkably, the science of genetics progressed for about five decades without any understanding of the physical basis of heredity. A brilliant hypothesis, that specific genes control the production of specific enzymes, was proposed by **George Beadle (1903-89)**, **Edward Tatum (1909-75)** and colleagues in 1940, based on the experimental work on the fungus *Neurospora*. In 1928, **Frederick Griffith** in the UK experimentally demonstrated that some substance is responsible for the transformation of one bacterial strain into another. **Oswald Avery (1877-1955)** and co-workers, in 1944, established DNA (Deoxyribo Nucleic Acid) as the cause of that transformation. The clinching evidence for DNA as the genetic material was provided by the ingenious experiment of **Alfred Hershey and Martha Chase**, in 1952, using radioactive isotopes. Just about this time **Erwin Chargaff (1905-)** made an important discovery that the proportion of purines always equalled that of pyrimidines in every organism. This discovery along with the X-ray diffraction data of DNA by **Rosalind Franklin and Maurice Wilkins (1916-)** were crucial to the historical announcement on 23 April 1953 of the double helical structure of DNA by **James Watson and Francis Crick**. The one-to-one complementarity of the base-pairs of the two strands in the double helix provided the clue for



the copying mechanism of DNA during cell division, and its unmistakable role in heredity. This single discovery dramatically changed the course of biology and advanced our understanding of almost every phenomenon within its fold.

The decades that followed saw relentless and breathtaking progress. The molecular understanding of a living organism, its development and functioning became clearer with each passing decade. We have learned to explore and manipulate the essential macromolecules and their dynamics. The spawning of the techniques of biotechnology has swept away the traditional barriers between



Fig: 18.14: Alfred Hershey (1908-77) and Martha Chase (1930-)

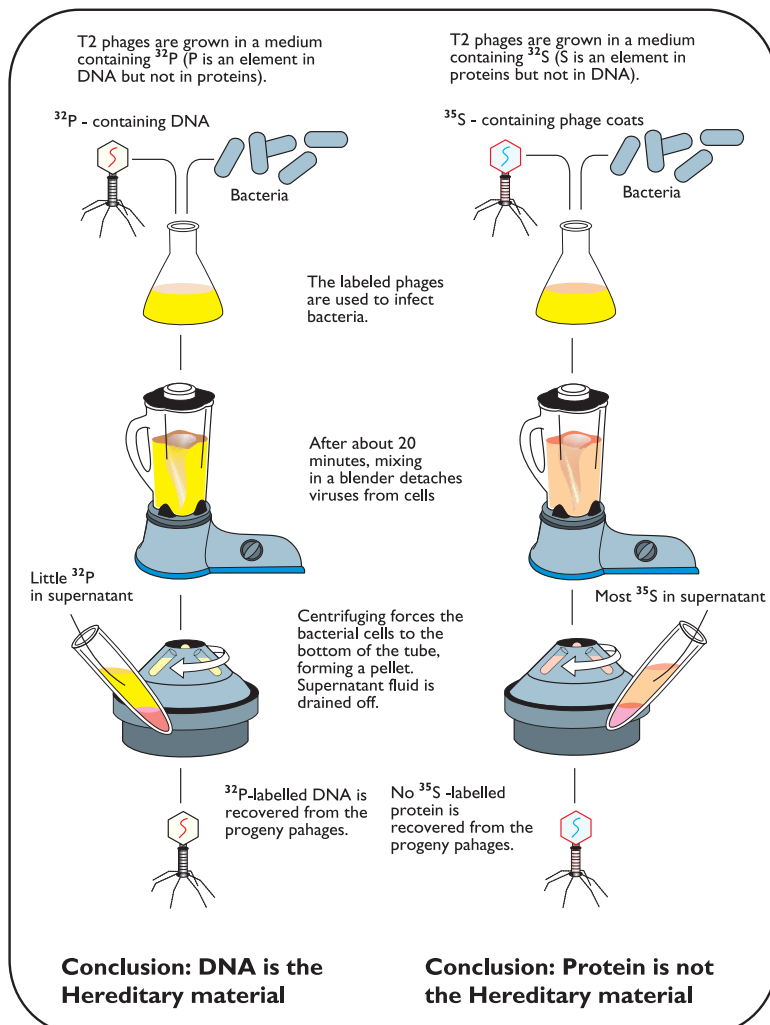

Fig: 18.15: The Hershey and Chase experiment conclusively demonstrated DNA as the hereditary material.



Fig: 18.16: Rosalind Franklin (1920-1958)

species. We are witnessing the dawn of a biotechnological revolution which promises to alter our agriculture, medicine, industry, ethics, law, indeed our entire life style and possibly even our own world-view. The human genome project has mapped and sequenced the entire human genome and has brought our civilization on the threshold of a second scientific revolution.

Despite its spectacular achievements in the twentieth century, biology remained largely an experimental and descriptive science. The exception was the theory of evolution which admitted sophisticated mathematical models. The last few decades, however, saw the emergence of strong scientific interest on the physics-biology interface and the theory of complex systems. Theoretical non-linear models incorporating the key features of complex systems – self-reproducing, selforganising, far from equilibrium, etc. – were explored in great detail. Yet a comprehensive theoretical framework that captures all the description of a living state still eludes us. And the problems of the biological basis of cognition, the origin of consciousness and related issues remain as enigmatic and unresolved as ever.

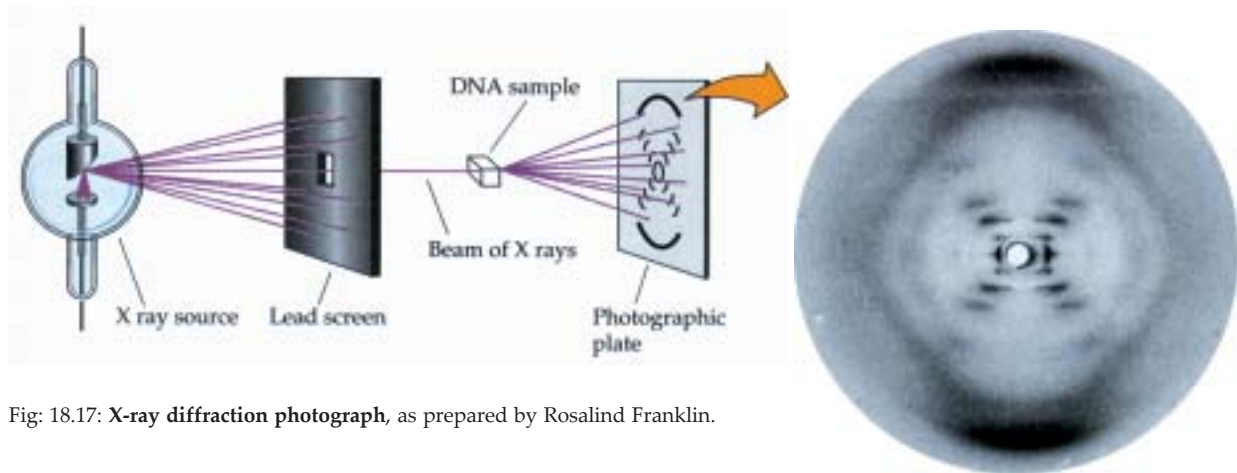

Fig: 18.17: X-ray diffraction photograph, as prepared by Rosalind Franklin.

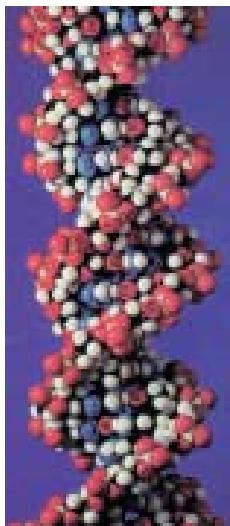

Fig: 18.18: A model of DNA double helix.

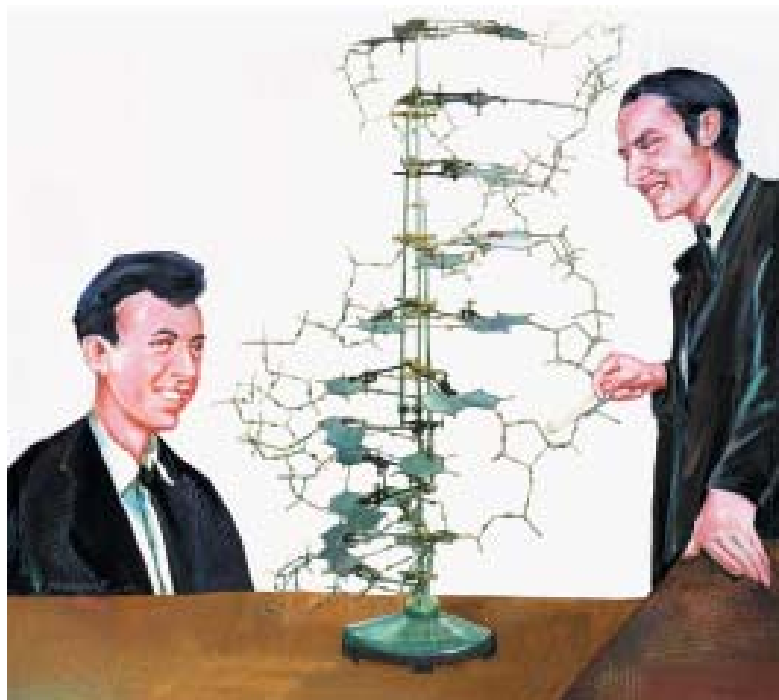

Fig: 18.19: James Watson (1928-) and Francis Crick (1916-) with their demonstration model of the DNA double helix.



Fig: 18.20: **Frederick Sanger (1918-)** determined the exact amino acid sequence of a protein, bovine insulin, in the 1950s. He also developed a technique for determining the sequence of nucleotides in a DNA molecule. He received Nobel prizes for both achievements, in 1958 and in 1980. The autoradiogram of a polyacrylamide gel, made by using Sanger's technique, shown in the picture reveals the sequence of more than 300 bases.



Fig: 18.21: **Francois Jacob (1920-), Jacques Monod (1910-1976) and Andre Lwoff (1902-1994)** in the 1960s, proposed the operon model, explaining how the synthesis of proteins (enzymes) is controlled in bacteria at the gene level by the regulatory genes and regulatory proteins. This was a breakthrough in understanding the complex phenomena of gene expression.

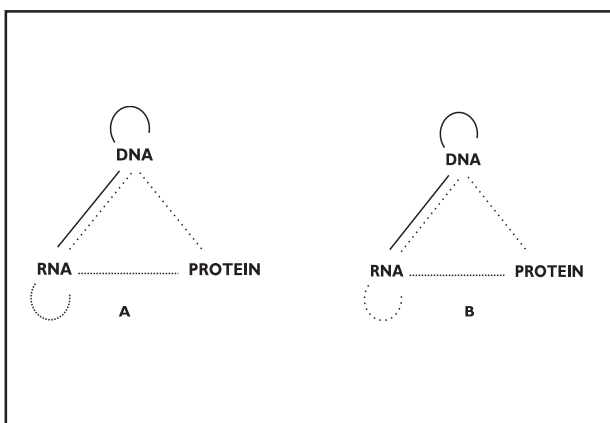

Fig: 18.22: **The Central Dogma of Molecular Biology:** Information flows from DNA to proteins and not vice versa. "Once information has passed into protein *it cannot get out again ... if you didn't believe that, you could invent theories, unlimited theories,*" said Francis Crick, proposing the central dogma of molecular biology, in 1958. The diagram (A) represents the dogma published in 1958 which was modified by Crick in 1970 (as shown in B). The solid arrows show transfer of information that occur in all cells and the dotted arrows show the information transfer in special cases.

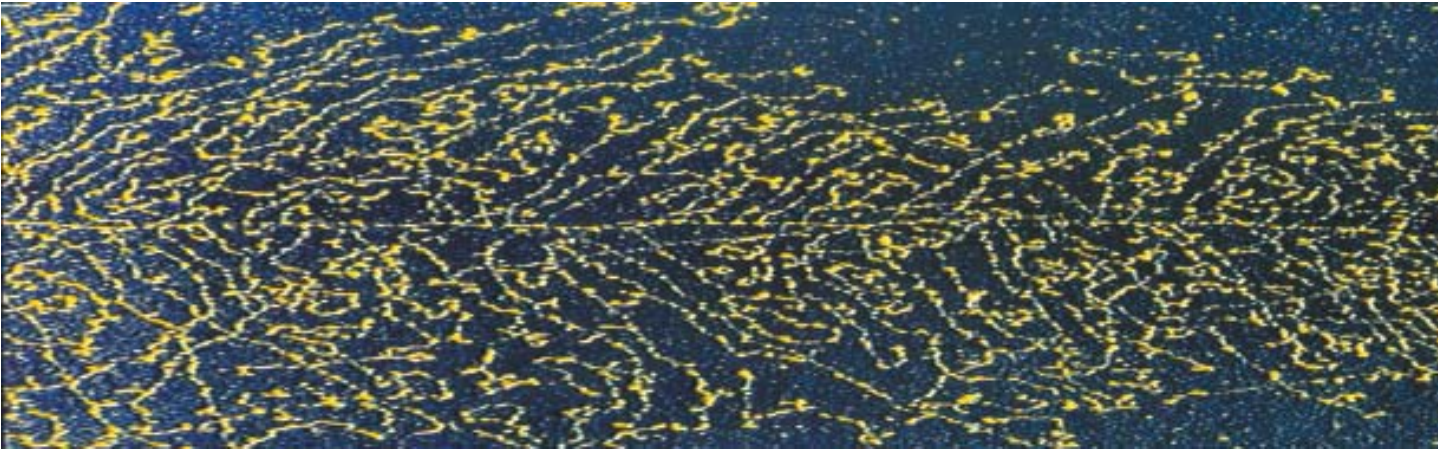

Fig: 18.23: **DNA in action:** The picture shows a process of transcription (DNA to mRNA). The horizontal thread is a segment of DNA molecule and the threads on either side are copies of mRNA molecules at different stages of their synthesis.

Fig: 18.24: **Marshall W. Nirenberg (1927-)** (shown in the inset) and co-workers cracked the genetic code in the 1960s. The genetic code is a linear sequence of any three of the four bases (adenine A, guanine G, cytosine C and uracil U), forming a triplet code. Each triplet code normally signifies an amino acid, and a sequence of them signifies a protein.



First Base	Second Base				Third Base
	U	C	A	G	
U	UUU phenylalanine	UCU serine	UAU tyrosine	UGU cysteine	U
	UUC phenylalanine	UCC serine	UAC tyrosine	UGC cysteine	C
	UUA leucine	UCA serine	UAA stop	UGA stop	A
	UUG leucine	UCG serine	UAG stop	UGG tryptophan	G
C	CUU leucine	CCU proline	CAU histidine	CGU arginine	U
	CUC leucine	CCC proline	CAC histidine	CGC arginine	C
	CUA leucine	CCA proline	CAA glutamine	CGA arginine	A
	CUG leucine	CCG proline	CAG glutamine	CGG arginine	G
A	AUU isoleucine	ACU threonine	AAU asparagine	AGU serine	U
	AUC isoleucine	ACC threonine	AAC asparagine	AGC serine	C
	AUA isoleucine	ACA threonine	AAA lysine	AGA arginine	A
	AUG (start) methionine	ACG threonine	AAG lysine	AGG arginine	G
G	GUU valine	GCU alanine	GAU aspartate	GGU glycine	U
	GUC valine	GCC alanine	GAC aspartate	GGC glycine	C
	GUA valine	GCA alanine	GAA glutamate	GGA glycine	A
	GUG valine	GCG alanine	GAG glutamate	GGG glycine	G

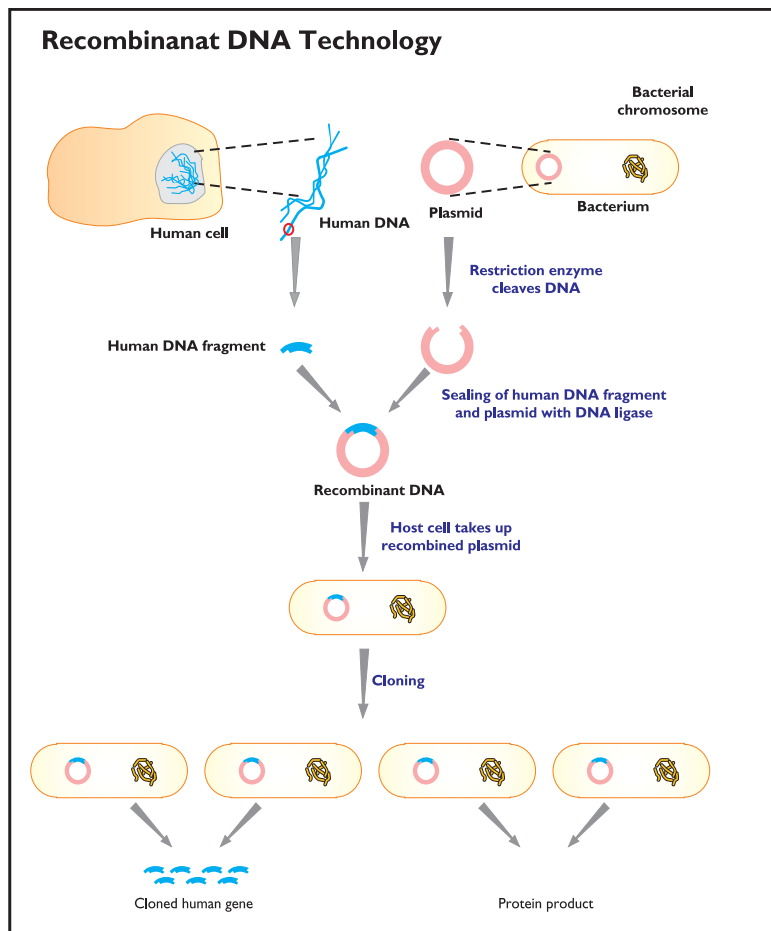
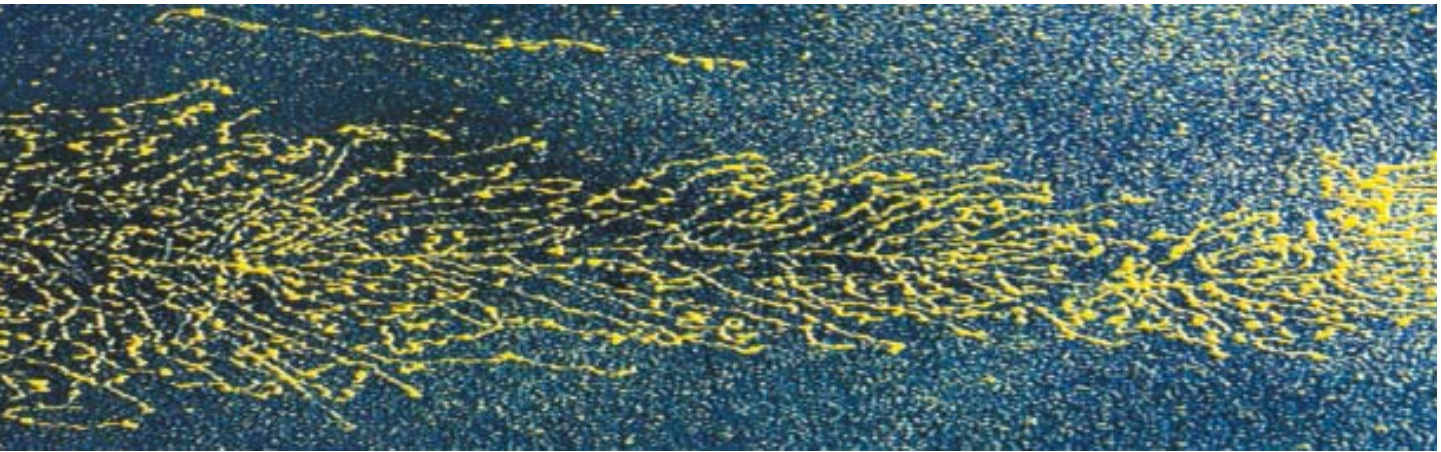

Fig: 18.25: Restriction enzymes were discovered in late 1960s by H. O. Smith (1931-), Werner Arber (1929-) and Daniel Nathans (1928-99). This discovery eventually made possible the recombination of plant and animal DNA fragments with the DNA of bacterium E. Coli by Stanley Cohen (1922-) and his colleagues in 1973. Recombinant DNA technology consists of cutting DNA at specific places, sticking together selected fragments to make a specially designed, recombined DNA molecule and allowing the new DNA to enter a cell. Here it becomes a part of the cell's genetic material and produces the protein product.

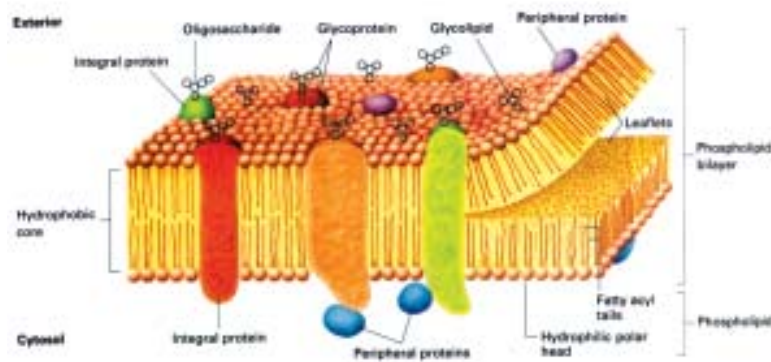

Fig: 18.26: S. Jonathan Singer and Garth L. Nicholson, in 1972, proposed the fluid mosaic model of the structure of cellular membranes. Based on the observations made by an electron microscope, the model suggested that phospholipids are bilayer, with proteins occurring as irregular globes that float around, within, and through the phospholipids. Membranes of cells and intra-cellular organelles (like mitochondria, chloroplasts, etc.) have characteristic membrane proteins. Membrane proteins carry out the complex, specialized, highly efficient activities of the cell such as: energy transduction of sunlight into chemical energy in chloroplasts, energy transformation reactions in mitochondria, inter and intra-cellular transport, communication, cell recognition, etc.

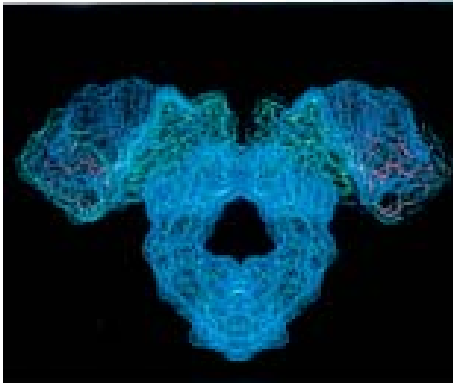
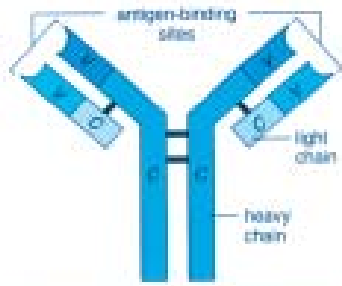

Fig: 18.27: **Immunology:** Our body's defence system is the consequence of the interaction among various types of white blood cells (leukocytes), and their products (antibodies, interleukines etc.). **Elie Metchnikoff (1845-1916)** discovered phagocytes: the cells capable of ingesting foreign particles and microorganisms. The work of **Robert Koch, Almorph Wright** and others laid the foundation of our understanding of another type of WBCs called lymphocytes. In the late 1970s, studies by **Susumu Tonegawa (1939-)** revealed how lymphocytes, using the library of genes, can synthesize an enormous variety of antibodies that can recognize most foreign substances entering into our bodies.



Fig: 18.28: A 'cellular scavenger' in action. Several types of white blood corpuscles in the blood 'engulf' or 'scavenge' the foreign bodies, protecting us from diseases.

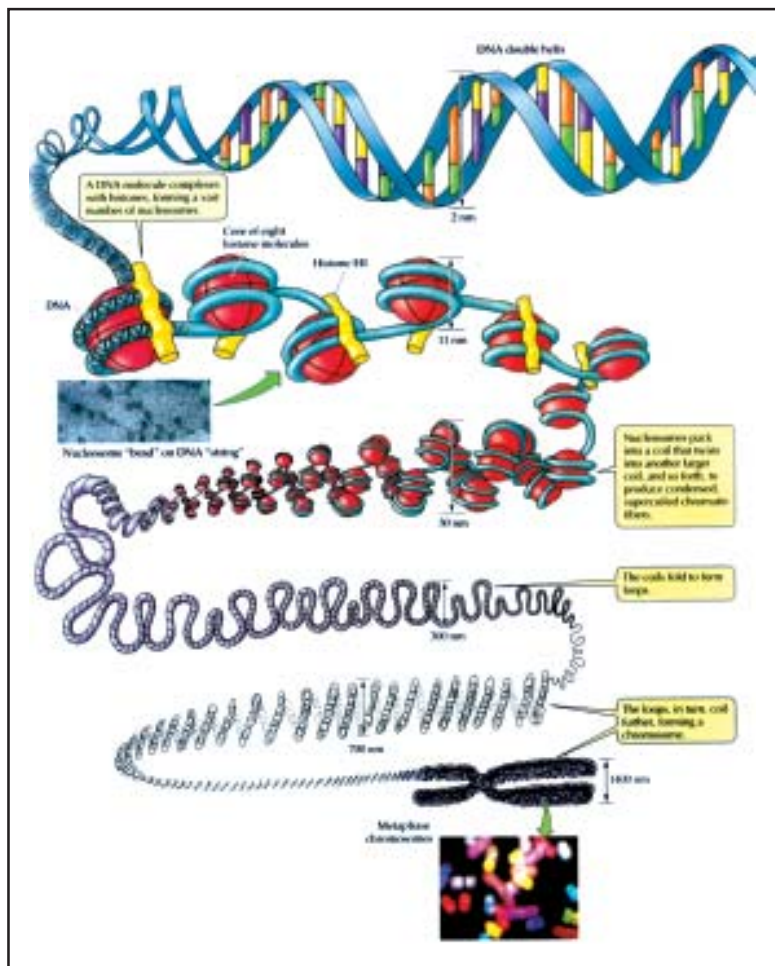

Fig: 18.29: A human chromosome contains a single DNA molecule of about 3-5 cm in length, which gets -5 packed into a 5 micron (10 cm) chromosome. **Komberg and Thomas (1974)** proposed the model of how DNA coils around protein beads (called nucleosomes) to produce a thread, which coils and super-coils into a packed chromosome.

Fig: 18.30: The change in the shape of platelets during blood clotting.



19

Computer Science

Around the 1960s emerged the new discipline of Computer Science that would impact every domain of our lives. The electronic digital computer was invented some two decades earlier. The key idea that made the transition from the calculator to the computer is programmability. The first programmable machine was made around 1800 by a French silk weaver called **Joseph-Marie Jacquard**. He used a pattern of holes in a string of cards for automatically controlling the warp and weft threads on a silk loom. In 1822, **Charles Babbage** proposed building a machine called the Difference Engine to automatically calculate mathematical tables, and soon conceived another machine called the Analytical Engine. The daughter of the English poet Lord Byron, **Augusta Ada Lovelace**, who worked with Babbage, created the first program for the Analytical Engine. The automated machines were large and were built for specific purposes. A break to this line of development came only after the synthesis of logic and electrical engineering.

George Boole's (1815-64) idea that the two propositional values, true and false, could be used to operate on logical expressions is the cornerstone of modern logic. **Claude E. Shannon** demonstrated in 1938 how Boole's idea could be used to represent the functions of switches in electronic circuits. Following Shannon's work, much attention was focussed on developing special purpose electronic logic machines mostly used as calculators. Circuits were designed with input values of 1's and 0's (representing true and false) to yield any desired combination of 0's and 1's as output. Most computers in the 1940s were built using vacuum tubes. The invention of the transistor and the miniaturization of circuits, magnetic and optical media for storage of information coupled with the increasing sophistication in software, led in time to the modern computers with their awesome power and speed in handling information.

Fig: 19.1: Blaise Pascal (1623-62)



Fig: 19.2: **Pascaline**, the true ancestor of the modern pocket calculator, was capable of operations with whole numbers. Made by Blaise Pascal in 1662, it worked in the same way as a car odometer.





Fig: 19.3: **Stepped Reckoner (1671)**: Gottfried Wilhelm von Leibniz, the philosopher and mathematician, invented a mechanical calculator that was similar to the Pascaline, but could also multiply, divide and calculate square roots.

Fig: 19.4: **Jacquard's Loom**, the first machine to use numerical control, was invented by **Joseph-Marie Jacquard (1752-1834)**. He designed the punched card (seen at the top) to represent a number for controlling the pattern of the weave of his loom. The punched cards were in use until recently for both feeding and storing data. They were replaced later by the key-board and storage disks.



Fig: 19.5: **Charles Babbage (1791-1871)**, a British mathematician, conceived the first machine that might be considered a computer in the modern sense of the word.





Fig: 19.6: The **Difference Engine** of Babbage automatically produced mathematical tables.

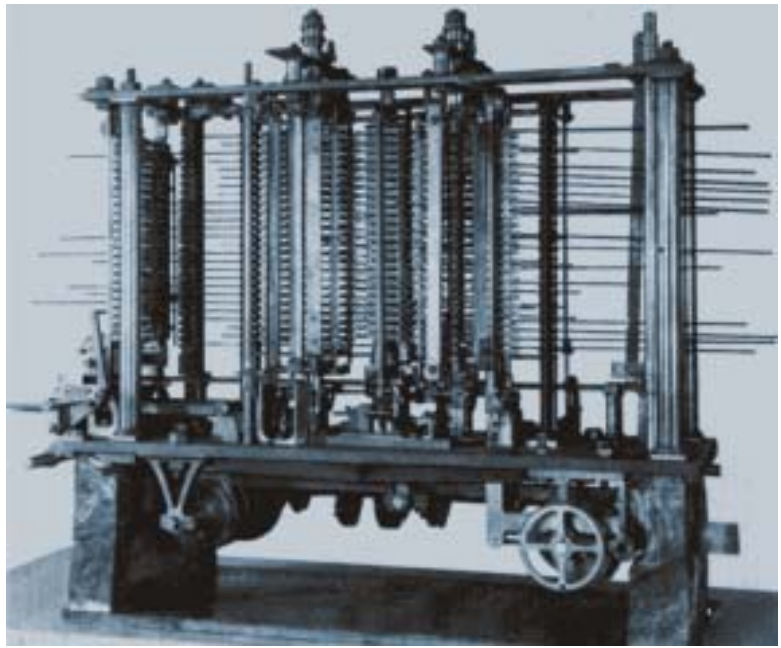

Fig: 19.7: **Analytical Engine** (1835), the world's first digital computer, was conceived by Charles Babbage in 1835. The first programs were written for this machine by Countess Lovelace (Augusta Ada Lovelace).



Fig: 19.8: A **punched card** for feeding information into the Analytical Engine



Fig: 19.9: **Augusta Ada Lovelace** (1815-52)

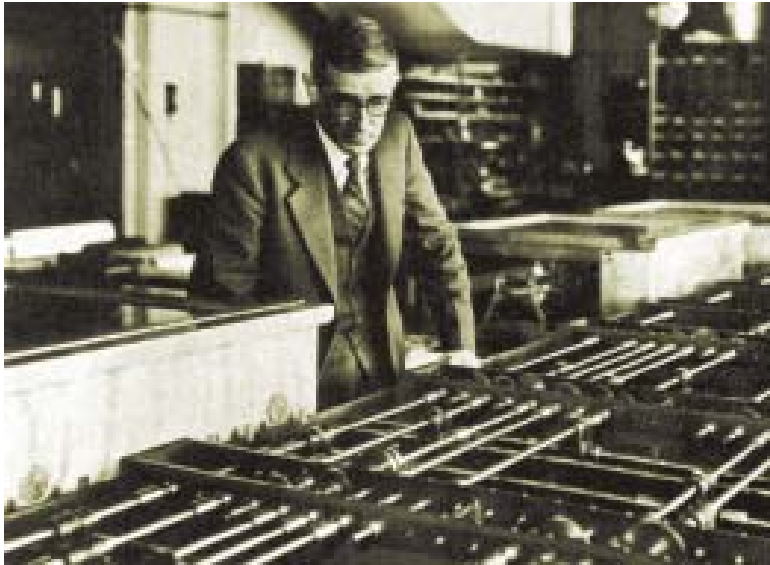

Fig: 19.10: **The Differential Analyser**, shown here with its inventor, **Vannevar Bush (1890-1974)**. He built the giant mechanical computer for solving differential equations. His machine was used to calculate artillery trajectories during the Second World War.

A milestone in theoretical computer science was the notion of the Turing Machine (a device that manipulates infinite strings of 0's and 1's) by the British mathematician **Alan Turing** in 1937. He also specified what kind of algorithms could be computed by automated machines. Later, in 1943, Turing developed a machine called Colossus, for decoding the ciphers during the World War II.

The first general purpose electronic computer was ENIAC (electronic numerical integrator and computer), built by **John William Mauchly** and **John Presper Eckert Jr.** during 1943-46 at the University of Pennsylvania. Mauchly and Eckert conceived the idea of creating stored-program computer. **Johann Von Neumann**, a brilliant mathematician, was excited by ENIAC and became a consultant at the University. In 1945 he drafted the architecture of a stored-program computer. Virtually all digital computers from this time onward had the architecture stipulated by Von Neumann.

Fig: 19.12: **John William Mauchly (1907-80)** and **John Presper Eckert (1919-95)** stand behind the console of Univac 1, an early model of their high-speed electronic computer.



Fig: 19.11: **William Shockley (1910-89)** holds a transistor for which he won (along with W. H. Brattain and John Bardeen) the Nobel Prize as co-inventor.



Fig: 19.13: **Claude E. Shannon (1916-2001)** developed a unified information theory in 1948. The chief concern of information theory is to discover mathematical laws governing systems designed to communicate or manipulate information. The theory has been applied to understand the mechanism of standard communications media, such as telegraphy, radio, television, electronic computers, servo mechanism systems and other data-processing devices. Information theory continues to be one of the major fields of current research, with inputs from emerging areas such as control theory and neural networks.

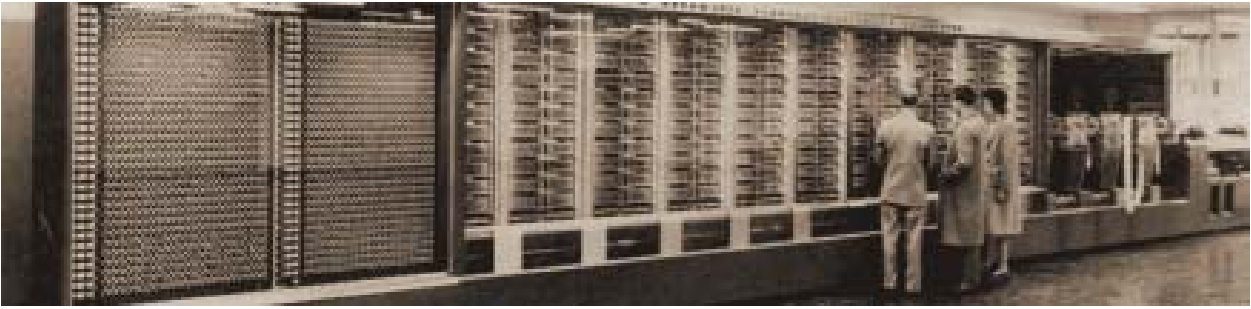

Fig: 19.14: Harvard Mark 1: The first fully automatic calculator built in 1944



Fig: 19.15: Alan Mathison Turing (1912-54)

The development of assembly languages which allow programmers to use mnemonics — instead of the machine language in terms of 0's and 1's — for instructing computers, and assemblers for coding and decoding was basic to the use of computers in scientific applications. Soon, even assembly languages became rather inconvenient and higher-level languages, such as FORTRAN, COBOL, Pascal, etc., were invented in the 1950s for easier and faster programming. This resulted in wider usage of computers in various domains. Later, functional and logic programming languages like LISP and PROLOG were developed specifically for artificial intelligence applications.

Despite the exponential advance in the field, computers were largely the preserve of institutions and corporate offices until about the mid seventies. The arrival of the Personal Computer (PC) dramatically altered this picture and brought this powerful artifact to the homes of millions of people. Yet the true information and communication revolution heralded by the modern computer began only in the 1990s with the growth of the internet and the world wide web. The convergence of a host of technologies woven around the computer, that is taking place at an astonishing pace, is likely to affect human civilization in ways that we cannot yet foresee.



Fig: 19.16: A Univac 490 computer has more than 7,700 printed circuits, requiring 70 miles of wiring to hook up its two million "memory cells". Still the degree of complexity is many times lower than the human brain.

The basic elements of a stored-program computer of Von Neumann:

1. A memory containing both data and instructions. Also to allow both data and instruction memory locations to be read from, and written to, in any desired order.
2. A calculating unit capable of performing both arithmetic and logical operations on the data.
3. A control unit, which could interpret an instruction retrieved from the memory and select alternative courses of action based on the results of previous operations.



Fig: 19.17: Johann Von Neumann (1903-57)

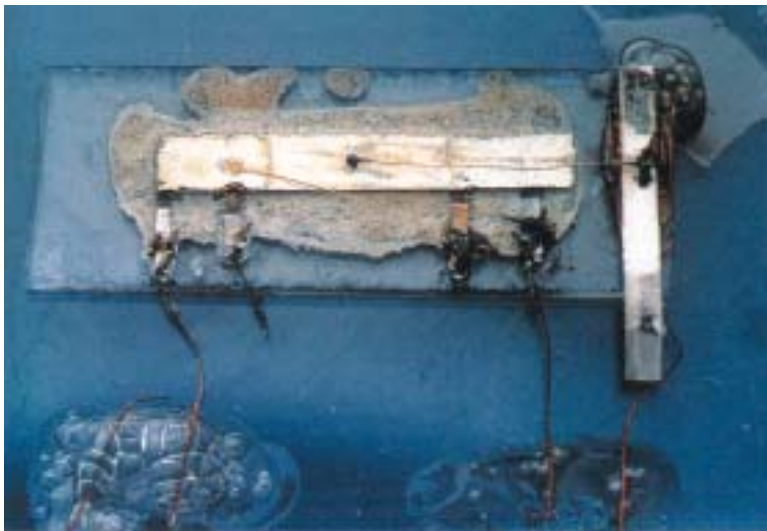

Fig: 19.18: The first integrated circuit (originally known as single crystal circuit) was invented by Jack Kilby (1923-) of Texas Instruments in 1958.

Some Fields of Study Connected to Computer Science

- Artificial Intelligence
- Computer Simulation and Modelling
- Robotics
- Natural Language Processing
- Speech Recognition
- Neural Networks
- Computer Based Learning
- Network and Communication Engineering
- Databases and Datamining
- Web Engineering



Fig: 19.19: Herbert Alexander Simon (1916-2001) considered goal-directed thinking as a foundation of problem solving algorithms. He along with his collaborator Alan Newell, conceived that computers might solve numerical or non-numerical problems by selective heuristic search. This realisation led to the foundation of artificial intelligence (AI).

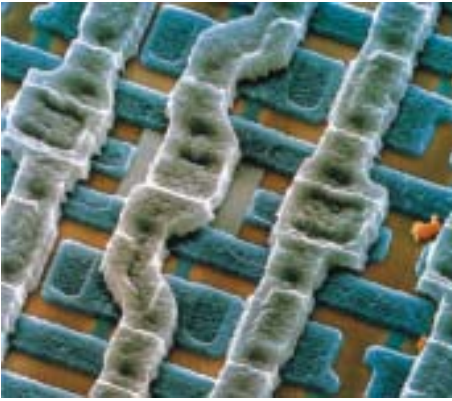

Fig: 19.20: Close-up of a Silicon Chip



Fig: 19.21: From the mind-boggling circuits made of wires as shown in the picture to the unimaginable compact chips that can fit in a palm, we have seen a major revolution in the computer technology.

Fig: 19.22: A cryogenic memory plane used in the fastest computers is not much bigger than the ordinary pins that are placed alongside it in the photograph. This unit has a network of 135 tiny rectangular cryotrons plated on its glass surface. Cryotrons are superconducting circuits that offer no resistance at very low temperatures.

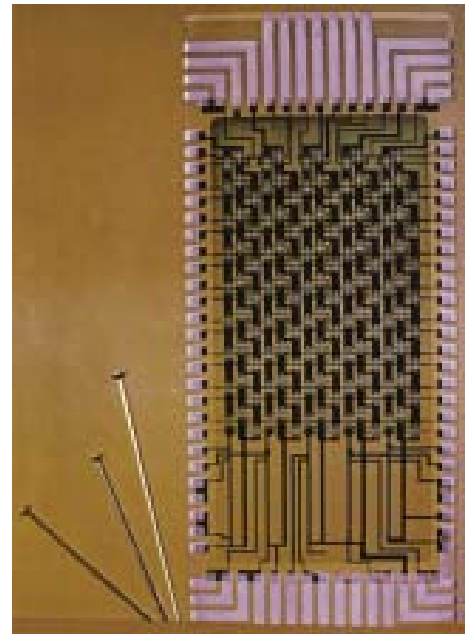

Fig: 19.23: Cray-1 Super Computer, made in 1976 was capable of 700 million operations a second.

Outlook



From the crude tools of early Stone Age to modern spacecrafts and supercomputers; from empirical observations on plants and animals to a molecular understanding of life; from the 'doctrine of four elements' to quarks and leptons; from the notion of zero to Godel's *Incompleteness Theorem*, the cumulative progress of science has been truly astonishing. This gigantic cultural endeavour of humans dating back from the ancient times made a steep and dramatic upturn when, about four centuries ago, it began to shed off its metaphysical trappings and turned to logic, observation and experiment as its

final arbiters. The methodology of science and its demarcation from other cultural domains continue to be a matter of philosophical debate. Its professed value-neutrality and objectivity have been subject to critical sociological analyses. Yet, with all its limitations and failings, modern science is unquestionably the most reliable and powerful knowledge system about the physical world known to humans.

For human welfare and happiness, however, science has been a mixed blessing. Modern science has influenced, in smaller or greater measure, nearly all human societies. Its enormous material benefits are obvious to everyone: the rise in agricultural production, the eradication of many dreaded diseases and increase in the longevity of life, the revolution in transport and communications and the remarkable progress in comforts and utilities, all made possible by science and its twin: technology. But with the power of science has also come its aberrations, exaggerated claims, and above all, its largescale misuse. Science and technology have often conspired with vested commercial and military interests to become tools of colonialism, imperialism and their latter-day incarnations. Science has been used for fraudulent claims of ethnic or racial superiority. Short-sighted and blinkered technology has played havoc with the planet's environment. The Third World has usually been at the receiving end of the technology misuse. But even within the Third World, science has often assumed exploitative and immoral role — witness the use of sexdetermination tests to abort female foetuses.

The gross misuse of science has alienated some people from the very enterprise of science and given rise to an anti-science movement in some quarters. This movement, though apparently eclectic and liberal in its outlook, is basically flawed. It refuses to acknowledge the superiority of modern science over other local underdeveloped knowledge systems existing in different parts of the world — systems which freely mix observations with myths and beliefs. In so doing it denies the very fact of human cultural evolution. The movement is also harmful because it unwittingly joins hands with the bigoted and narrow interests who, for different reasons, see in science a threat to their own survival.

Yet, science in its true spirit is a most ennobling and liberating human endeavour — on par with the other universal responses of humans to their existence: arts, music, literature and deep religious and spiritual quests. In a progressive democratic social frame-work, its misuse can be avoided through collective conscience and its emancipatory role can be brought to fruition. The great architects of modern India had just this vision of science not only for our country but for the world at large.

With its ancient tradition of scholarship and pursuit of pure knowledge, India witnessed, after an unfortunate quiescent period of several centuries, a resurgence of science and is now on its world map. Yet, its true potential of becoming a major science power is far from being realized. As the new century begins, we must rise to the challenge of creating a vibrant scientific and technological culture in India that would help us participate as equal partners in the great global enterprise that is modern science.