

# ESO'S EARLY HISTORY



The European Southern  
Observatory from  
concept to reality

Adriaan Blaauw

*The front cover is based on the painting by Nemesio Antúnez reproduced on page 125, a photograph of which was kindly made available by the Swedish Council delegate to ESO.  
Design by Edmond Janssen*





## **ESO'S EARLY HISTORY**

*This book is dedicated to my collaborators and to those even closer to me, whose devotion, and for some of them even personal sacrifice, remain in my memory of these early years.*

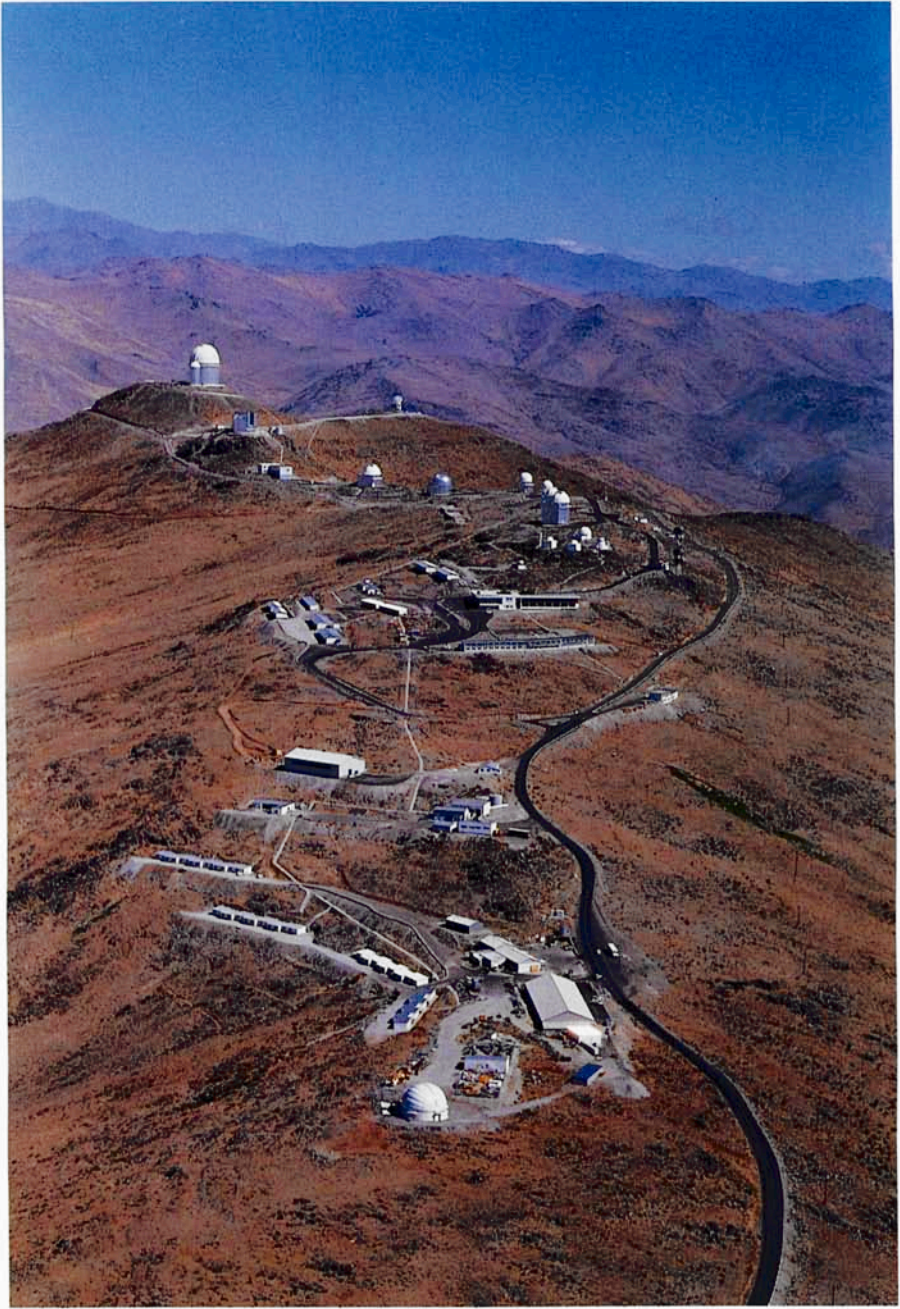

*The European Southern Observatory in 1991.*

# ESO'S EARLY HISTORY

The European Southern Observatory  
from concept to reality



Adriaan Blaauw

EUROPEAN SOUTHERN OBSERVATORY  
Karl-Schwarzschild-Str. 2, D-8046 Garching bei München  
Germany

© Copyright 1991 by the European Southern Observatory  
ISBN 3-923524-40-4



# CONTENTS

	page
Foreword by the Director-General of ESO. . . . .	XIII
Author's Preface . . . . .	XV
<b>I STRIVING TOWARDS THE CONVENTION</b>	<b>1</b>
A Historical Statement . . . . .	1
Towards the Convention . . . . .	7
Withdrawal of Great Britain . . . . .	9
The Grant of the Ford Foundation . . . . .	10
Founding Fathers . . . . .	12
The Final Struggles . . . . .	14
<b>II SEARCHING FOR A SITE IN SOUTH AFRICA</b>	<b>19</b>
Introduction . . . . .	19
First Impressions . . . . .	19
Astronomical "Seeing" (box) . . . . .	21
Adding Some "Real" Astronomy . . . . .	25
The Quick-Look Expedition . . . . .	27
The Comprehensive Programme, 1961–1963 . . . . .	31
Last Tests in South Africa: the Siedentopf Experiment . . . . .	34
The Tübingen Photometric Project . . . . .	35
The Marseilles GPO Project . . . . .	35
The Comprehensive Reports on the South African Tests . . . . .	38
At the End, Bewilderment and Consent. . . . .	41
For South Africa, a Word of Gratitude . . . . .	41
<b>III 26 MAY 1964: ESO CHOOSES LA SILLA</b>	<b>43</b>
Jürgen Stock's Early Explorations . . . . .	43
ESO's Growing Interest in the Andes . . . . .	44
Muller and McSharry Join Stock's group . . . . .	48
The June 1963 AURA-ESO Summit Meeting in Chile . . . . .	49
Follow-up on the Summit Meeting . . . . .	50
ESO Chooses the Andes Mountains for its Observatory . . . . .	55
The Convenio with Chile . . . . .	56
The Relation to AURA . . . . .	57
ESO chooses La Silla. . . . .	58

IV	COUNCIL AND DIRECTORATE SET TO WORK; THE INITIAL PROGRAMME OF MIDDLE-SIZE TELESCOPES	65
	Introduction . . . . .	65
	Heckmann Becomes ESO's First Director, November 1962 . . . . .	65
	Council and Finance Committee . . . . .	67
	Earliest Developments in Instrumentation . . . . .	69
	ESO's Oldest Committee, the Instrumentation Committee . . . . .	70
	The Middle-Size Telescopes . . . . .	73
	The 1-Metre Photometric Telescope . . . . .	74
	The Spectrographic Telescope . . . . .	76
	The GPO (Grand Prism Objectif). . . . .	78
	The Astrolabe . . . . .	80
	ESO chooses its Emblem . . . . .	81
V	EARLIEST DEVELOPMENTS IN CHILE; 24 March 1966: The Road on la Silla Dedicated	83
	Introduction . . . . .	83
	The Acquisition of the La Silla Territory . . . . .	85
	Building up the Observatory; First Step: Road and Camps . . . . .	85
	The Problem of the Mining Rights . . . . .	90
	The Building Programme; Early Architectural Planning . . . . .	91
	Progress over the Years 1964–1966. . . . .	93
	Organizational Structure and Employees . . . . .	95
	The ESO Guesthouse . . . . .	96
	Council Meeting and Dedication, March 1966. . . . .	98
VI	FURHTER DEVELOPMENTS IN CHILE; 25 March 1969: The First Phase Dedicated; The Introduction of National Telescopes	101
	The Inauguration . . . . .	101
	Developments on La Silla, 1967–1969. . . . .	103
	The Santiago Headquarters . . . . .	106
	The Vitacura Donation . . . . .	111
	The National Telescopes . . . . .	112
	The First National Telescope: the Bochum 60-cm . . . . .	112
	The Danish 50-cm Telescope. . . . .	115
	The Danish National 1.5-m Telescope; Basic Considerations . . . . .	115
	The Dedications. . . . .	119
	The Dedication Symposium on the Magellanic Clouds . . . . .	122

VII	THE LATE 1960'S: Structural Changes, First Scientific Activities and Some Soul-Searching; the Journal A & A	123
	Introduction	123
	Changes in the Directorate	123
	Earliest Scientific Activities and the Creation of the SPC	124
	The Scientific Programmes Committee (SPC)	126
	The First Coopérants	132
	The Roden Colloquium on Photometry of February 1966 and the Nice Colloquium on Spectroscopy of June 1969	132
	The Allocation of Observing Time	133
	The SPC and the Future: More Telescopes and an ESO Centre?	134
	The Proposed New Telescopes	136
	Soul-Searching in the Late 1960's	139
	The Report of the Working Group	142
	Creation of Committee of Council	143
	ESO and the Creation of the Journal A & A	143
VIII	THE 3.6-M TELESCOPE PROJECT FROM CONCEPT TO THE LATE 1960'S	147
	Introduction	147
	Basic Concepts	147
	Early Conferences and Texts	148
	The Choice and Ordering of the Optics	149
	The Mirror Cells	154
	Tube and Mounting; Strewinski's Pre-Design	155
	The Combined Horse-Shoe and Fork Mounting	160
	Stagnation – and Growing Impatience	162
	The IC Meetings in 1969	163
	The Building	166
	The Dome	167
	Automation in Telescope Control	167
IX	THE 3.6-M TELESCOPE PROJECT DIVISION; ESO COLLABORATES WITH CERN	169
	ESO Approaches CERN	169
	Consultation with ESRO	171
	The Documents Cou-59 and Cou-60 of December 1969	171
	Pursuing the In-House Group Concept: Doc. Cou-66	173

	First ESO Committee of Council Meeting, May 6, 1970 . . . . .	177
	Council Resolves to Collaborate with CERN . . . . .	180
	September 16, 1970: the ESO-CERN Agreement Signed . . . . .	182
	A Few Further Milestones . . . . .	185
X	THE SCHMIDT TELESCOPE: Design, Construction, the ESO-SRC Agreement and the Onset of Survey Projects . . . . .	187
	Bernhard Schmidt and Early Developments at Hamburg Observatory . . . . .	187
	Planning the ESO Schmidt . . . . .	189
	Mechanical Engineer and Manufacturer . . . . .	191
	Some Design Features . . . . .	192
	A Daring Design, not Realized . . . . .	192
	The Optics . . . . .	193
	Mechanical Construction and First Tests . . . . .	193
	Heckmann's Concern in Retrospect . . . . .	195
	Steps Toward Perfection . . . . .	198
	The Sky Atlas Laboratory . . . . .	200
	The Quick Blue Survey . . . . .	203
	A British Sister for the ESO Schmidt . . . . .	203
	The Hamburg Conference on Schmidt Telescopes . . . . .	205
	The ESO-SRC Agreement . . . . .	205
	The ESO-Uppsala Faint Galaxies Survey . . . . .	208
XI	POLICY, PAYMENTS AND A BIT OF POLITICS . . . . .	211
	Introduction . . . . .	211
	MATTERS OF POLICY . . . . .	212
	(A) ESO, A Centre for Research? . . . . .	212
	The Scientific Policy Committee Created . . . . .	213
	A Research-Oriented Group at ESO? . . . . .	214
	The Workshop Proposal . . . . .	215
	A Formal Statement from German Side . . . . .	220
	Response by Directorate and SPC, Doc. Cou-150 . . . . .	221
	Council's Resolution December 1973; the German Offer . . . . .	221
	The Political Aspect . . . . .	224
	The Year 1974: the Centre in Sight . . . . .	224

(B) ESO's Geographical Dispersion . . . . .	225
Extension of Facilities in Chile . . . . .	225
Moving "Vitacura" to La Serena? . . . . .	226
The Year 1974: Restructuring in Sight . . . . .	229
THE FINANCIAL STORY . . . . .	232
The Pre-Convention Period, 1954–1963. . . . .	232
About Dollars and Deutschmarks. . . . .	233
Early Annual Contributions and Project Costs . . . . .	234
Early Cost Estimates . . . . .	234
The Post-Convention Years . . . . .	235
The Annual Contributions from 1964 . . . . .	236
Conflicting Interests and the Bannier Procedure . . . . .	236
First Post-Convention Years, 1964–1969 . . . . .	238
The Years 1971–1976; the TP Division . . . . .	238
Overall Developments Since 1954. . . . .	239
REFERENCES AND NOTES . . . . .	242
ANNEXES	
1 The ESO Historical Archives (EHA) . . . . .	253
2 The Ford Foundation and ESO . . . . .	255
3 Meetings of the ESO Committee, 1953–1963 . . . . .	256
4 Meetings of the Instrumentation Committee, 1961–1974 . . . . .	257
5a Meetings of Council and Finance Committee, 1964–1969 . . . . .	258
5b Meetings of Council, Committee of Council and Finance Committee, 1970–1974. . . . .	259
6 Meetings of Scientific Programmes Committee, Observing Programmes Committee and Scientific Policy Committee, 1968–1974 . . . . .	260
SUBJECT INDEX . . . . .	261
NAME INDEX . . . . .	264



## FOREWORD

People's interest in history seems bimodally distributed. There are those who nod at the phrase "history is bunk" and in my experience physical scientists are overrepresented in this category, although physicists perhaps more so than astronomers. Then there are the others whose fascination by history is rooted in the awareness that to deny the importance of history is tantamount to denying the meaning of our own efforts in the present.

When Professor Blaauw gingerly broached the subject of writing an ESO history early in 1988, I was immediately enthusiastic. I had read several of his biographical articles about great astronomers of the past, his history of his 17th century farmhouse and of the village of whose fabric its inhabitants were part. I knew of his meticulous research, his perceptive insights into men's motives and interactions, his crisp style and relaxing humour. We discussed the problem of his own responsibilities and the question "can you write the history which you have made in part yourself"? The issue was resolved as the author sketches in the preface.

This book is a comprehensive, though not complete, account of our Organization's conception, gestation, birth and growth to adulthood. It is a case study of astronomy in post-World War II Europe, of the struggles to overcome a variety of isolations. It shows how, ever so slowly, fragmentation of talents, of resources and of goals was replaced by collaboration, by choosing big aims, by selecting quality through peer review, by efforts to get many to see the contours of a vision worthy of a continent.

Adriaan Blaauw was there from the very first moment, he was fully involved for more than a quarter century; he particularly devoted all his talents and energy to ESO for five years. When he retired as Director General at the end of 1974, his *engagement* continued, for ESO as an idea, as an organization for the service of European astronomy, as a multimode team of people. This *engagement* now spans four decades, and this book is but one of its fruits. Successful enterprises have common features, both painful and inspiring ones. Pettiness is never absent, hinders progress and obscures the perspectives which form the stuff of history. Progress is borne and, if need be, pushed by strong wills, clear minds and above all generous spirits. ESO's present existence we owe to a few such men of vision (women appear in modest roles in ESO's history, only in 1983 does Council welcome the first woman among its members!). Most of them, in functions prominent or modest, gave their best talents and persistent courage to projects which they would not profit from for their personal advancement, in career, research or reputation. Such generosity and strength made ESO's present and are the prerequisites for the future, too.

This book appears nearly four years into ESO's second quarter century. This period will be dominated by the Very Large Telescope even more than the first quarter century was dominated by the 3.6 m telescope. Very many of the struggles and problems described in this book, whether they be technical, organizational, political or financial, are inevitably repeating themselves. We can learn from history and more effectively steer the course of ESO's future because its past has now been documented. Adriaan Blaauw has done European astronomy at large and the European Southern Observatory in particular a service only he could render with such authority and wholeness.

Harry van der Laan  
Director General

La Silla  
August 1991



## PREFACE

This book tells about the origin and the earliest developments of the European Southern Observatory (ESO), the large astronomical observatory in the Chilean Atacama Desert operated jointly by Belgium, Denmark, France, Germany, Italy, the Netherlands, Sweden and Switzerland. After a description of the first initiatives towards its creation in June 1953, we follow the growth over two decades until, in the middle of the 1970's, a dream had become reality. These were decades of optimism and disappointments, ups and downs and perseverance, in post-war years when international collaboration opened up new perspectives for scientific research. A new Europe was in the making, and ESO one of the building stones – small but plucky – in the grand overall process.

Since that memorable day in the spring of 1953, when my friend and colleague Jan Oort entered my office next door to his at Leiden Observatory, and told me with excitement about Walter Baade's idea that European astronomers should establish their common large observatory, I witnessed first steps and became more and more involved in the realization of this project; the years 1970 to 1975 as Director General. This latter capacity seemed to set a natural limit to the period to be covered by my account, for isn't it better to leave the description of developments during one's own Directorate to another historian? On the other hand, it would have been rather unsatisfactory to stop the narrative at the day I assumed this Office. The best thing to do seemed to aim at a compromise and follow into the period of my Directorship main developments that had their roots well before this period, the most important of which were the realization of the 3.6-m Telescope and that of the Schmidt Telescope and its related Sky Surveys, and to refrain from dealing with later developments.

Accordingly, I have not touched such major subjects as:

- the scientific activities by visiting astronomers and ESO's astronomical staff in Chile, activities that assumed momentum after the inauguration of the Observatory in 1969, and in which the Director for Chile, Bengt Westerland, and the Observing Programmes Committee (chaired first by Bengt Strömberg and next by Pol Swings and Paul Ledoux) played a major role;
- the detailed description of the realization of the 3.6-m Telescope by the TP Division; only a few milestones in this major effort are mentioned in chapter IX;
- the construction programme in Chile, where parallel to the work of the TP Division a wide range of facilities and infrastructure had to be created in preparation for the operational phase of the 3.6-m Telescope;
- the extensive work on the framework of conditions governing the legal and financial position of the ESO staff, leading to ESO's Staff Rules and Regulations and to the Multilateral Protocol introduced about 1975.

Whom did I have in mind as readers of this history? Naturally, first of all scientists and non scientists who are, or have been, employed at ESO or in some other way have been involved in its development, as well as the young generation of astronomers of whom I know that some are definitely interested in the origin of their beautiful Observatory. Also, however, a more remote category: those who consider ESO as a successful experiment in mid-20th century Europeanization, a case study that some time may be of interest in broader historical context.

The treatment is thematic rather than strictly chronologic, and reflects the fact that most of the contents of this book was the subject of a series of articles in the *ESO Messenger* from December 1988 to June 1991; a circumstance of which traces may well be noted here and there in this book. Such thematic treatment naturally implies omission of some less prominent topics and thus the book lacks completeness.

A job like this could not possibly have been done without the extensive help and encouragement from many sides.

At the Kapteyn Laboratory at Groningen, I was gently pushed from the typewriting into the word-processing era. The flexibility of this new way of writing has much contributed to the contents of the book. However, this would have been beyond my reach without the always so readily given help of the Laboratory's staff, especially that received from Theo Jurriëns.

At ESO Headquarters at Garching, encouraged by Director General Harry van der Laan, I started in the year 1988 by establishing the ESO Historical Archives as a necessary basis for the historical account. Besides these Archives, the rich files of the Head of Administration, Gerhard Bachmann, became an indispensable source of documentation. In the preparation for publication in *Messenger* and book I enjoyed the indispensable help of Kurt Kjär.

A number of comments received with reference to the *Messenger* articles hopefully have led to improvements. I wish to acknowledge explicitly those received from J. Dommaget, F.K. Edmondson, E. Geyer, U. Haug, E. Maurice, A.B. Muller, and F. Noël.

After a decade of remoteness, it was gratifying to be back regularly in the ambience of ESO's capable and helpful staff and to witness how strongly ESO has become the European meeting place for astronomers – three and a half decades after its feeble birth cries were heard.

Garching – Groningen – Pouzols Minervois, Spring 1991.

The author

## I. STRIVING TOWARDS THE CONVENTION

*“L’astronomie est bien l’école de la patience.”*

From a letter by A. Danjon to J.H. Oort, 21 September 1962.

### A Historical Statement

On January 26, 1954 twelve leading astronomers from six European countries issued the historical statement we reproduce below [1]. It carries the signatures of Otto Heckmann and Albrecht Unsöld of the German Federal Republic, Paul Bourgeois from Belgium, André Couder and André Danjon from France, Roderick Redman from Great Britain, Jan Oort, Pieter Oosterhoff and Pieter van Rhijn from the Netherlands, and Bertil Lindblad, Knut Lundmark and Gunnar Malmquist from Sweden.

The statement (drafted by Danjon, Oosterhoff and Redman) expresses the wish that the scientific organizations in the respective home countries recommend to the authorities concerned, the establishment of a joint observatory in South Africa, equipped with a telescope of 3 metres aperture and a Schmidt telescope of 1.2 metres aperture. In the paragraphs preceding the expressed wish, they present the considerations that led them to this statement. Their wish would ultimately lead to the Convention between five of these six countries – Great Britain went its own way – signed on 5 October 1962. By that time almost ten years had passed since the notion of a joint European observatory had been expressed for the first time. Another year and three months would have to elapse until the impatient hands of the astronomers would be free to lay the first solid foundations for the erection of the observatory. The date is January 17, 1964 when, with the completion of a series of parliamentary ratifications, not only the moral, but also the financial commitments of the respective governments had been ensured.

In this book I shall first describe the developments of the first decade, that is the period preceding the signing of the Convention and the Ratifications, and next cover some of the later developments until the year 1975 when I passed on the General Directorate of the Organization to my successor Lodewijk Woltjer.

The earliest decade was one of ups and downs – many downs! – in a struggle which may seem surprising to the present young generation of astronomers, and can be fully understood only when seen against the background of a damaged Europe, a decade only after devastating World

## I. STRIVING TOWARDS THE CONVENTION

Les soussignés, astronomes appartenant aux pays ci-après désignés: Allemagne, Belgique, France, Grande Bretagne, Pays Bas, Suède, réunis à Leyde le 25 et 26 janvier 1954,

Considérant

Que l'astronomie occupe dans la science contemporaine une position essentielle et que diverses branches de la science qui ont récemment bénéficié de ses progrès sont appelées à en bénéficier encore dans l'avenir,

Que l'étude de l'hémisphère céleste austral est beaucoup moins avancée que celle de l'hémisphère boréal, la plupart des grands instruments étant situés dans l'hémisphère terrestre nord, en particulier ceux du Mont Palomar,

Que, par suite, les données sur lesquelles repose la connaissance de la Galaxie sont loin d'avoir la même valeur dans les diverses parties du ciel et qu'il est indispensable de les améliorer et de les compléter là où elles sont insuffisantes,

Que, notamment, il est hautement regrettable que, le noyau galactique du Sagittaire, la plupart des amas globulaires, les Nuages de Magellan, les systèmes extragalactiques de Fornax et de Sculptor, c'est-à-dire des systèmes qui n'ont pas d'équivalent dans l'hémisphère nord, soient presque inaccessibles aux plus grands instruments actuellement en service,

Qu'en conséquence, il n'y a pas de tâche plus urgente pour les astronomes que d'installer dans l'hémisphère austral de puissants instruments, comparables à ceux de l'hémisphère nord, notamment un télescope réflecteur d'au moins 3 m d'ouverture et une chambre de Schmidt de 1,20 m,

Mais que, d'autre part, faute de ressources suffisantes, aucun pays ne semble en mesure d'assurer l'élaboration et la réalisation d'un tel projet, que seule une coopération internationale permettrait de mener à bonne fin,

Que la participation à cette entreprise, de tous les pays adhérant à l'Union Astronomique Internationale, par exemple, entraînerait de grandes complications et qu'il paraît sage de limiter actuellement le nombre des participants à quelque pays voisins formant un groupe restreint,

Que ces pays de l'Europe occidentale, en s'associant pour la construction et le fonctionnement d'un observatoire commun situé en Afrique du Sud, ouvriraient aux astronomes européens un champ de recherches peu exploré et d'une grande richesse,

Que la participation à cette entreprise des six pays sus-mentionnés paraît indispensable pour en assurer le succès,

Emettent le voeu

Que les organisations scientifiques représentatives de ces six pays recommandent aux autorités qualifiées la construction en Afrique du Sud d'un observatoire commun, doté, notamment, d'un télescope de 3 m d'ouverture et d'une chambre de Schmidt de 1,20 m.

Ont signé:

Prof. O. Heckmann  
Directeur de l'Observatoire de Hambourg

*O. Heckmann.*

Prof. A. Unsöld  
Directeur de l'Observatoire de Kiel

*Albrecht Unsöld.*

Dr. F. Bourgeois  
Directeur de l'Observatoire royal de Belgique

*F. Bourgeois*

Dr A. Couder  
Astronome de l'Observatoire de Paris

*A. Couder*

Prof. A. Danjon  
Directeur de l'Observatoire de Paris

*A. Danjon*

Prof. R. O. Redman  
Directeur de l'Observatoire de Cambridge

*R.O. Redman.*

Prof. J. H. Oort  
Directeur de l'Observatoire de Leyde

*J.H. Oort.*

Prof. P. Th. Oosterhoff  
Astronome de l'Observatoire de Leyde

*P.Th. Oosterhoff*

Prof. P. J. van Rhijn  
Directeur du Laboratoire Astronomique "Kapteyn"  
Groningue

*P.J. van Rhijn*

Prof. B. Lindblad  
Directeur de l'Observatoire de Stockholm

*Bertil Lindblad*

Prof. K. Lundmark  
Directeur de l'Observatoire de Lund

*Knut Lundmark*

Prof. K. G. Malmquist  
Directeur de l'Observatoire d'Uppsala

*Knut Malmquist*

On January 26, 1954 astronomers from six European countries gathered in the stately Senate Room of Leiden University for a discussion of the recently suggested joint European Observatory. Under the chairmanship of Bertil Lindblad of Saltsjöbaden they formulated and duly signed the statement reproduced here, meant to strengthen their efforts for government support in the respective countries.

War II. Traditional nationalism and mutual misgiving had to be replaced by joint effort. As my colleague and friend Charles Fehrenbach used to say: "Il faut faire l'Europe." It also was a time at which some of the European countries had to deal with serious internal problems. Governments as well as astronomers had to face this. It is perhaps not surprising, then, that the first instigation towards the joint effort which would become ESO, had to come from one who, although rooted in European ancestry, had been an onlooker on European astronomy for many years from overseas: Walter Baade of the Mount Wilson and Palomar Observatories.

Baade, renowned expert on galactic and extragalactic research, had been invited by Oort to spend two months at Leiden Observatory in the spring of 1953, for lecturing and for collaborating in the preparation of a conference on galactic research to be held near Groningen from June 22 to 27 [2]. It was during this stay that, between Baade and Oort, the idea arose of a joint effort by some European countries with leadership in astronomy [3].

The suggestion was followed up by Oort immediately. At his invitation a group of astronomers discussed it on June 21, 1953, the day before the Groningen conference [4]. They were Baade, Bourgeois, Danjon, Heckmann, Lindblad, Oort, Oosterhoff and myself. Most of them participated in the Groningen conference [5]. Also present on June 21 was J.H. Bannier, director of the Dutch national science foundation (ZWO) and at that time President of the Council of CERN, the joint European effort in nuclear research. Over the years, the ESO effort would greatly benefit from Bannier's experience. The participants at the meeting represented five "continental" countries. After the meeting Sir Harold Spencer Jones, Astronomer Royal of Great Britain, and Richard Stoy of the Cape Observatory, both of whom also participated in the Groningen conference, were informed and contributed their views. It appears from the minutes of the June 21 meeting that Baade's ideas deeply influenced the discussions and, in fact, his proposal then made would become the nucleus of the "initial programme" formulated in article II.2 of the 1962 Convention. It is therefore interesting to report in some detail from these minutes.

Baade proposed as principal instruments a 120-inch reflector similar to that of Lick Observatory in combination with a 48-inch Schmidt telescope like the one on Mt. Palomar. The fact that for both telescopes existing designs could be used and engineering problems had been solved would speed up the project. The southern hemisphere for the location of these instruments was an obvious choice for several reasons. At that time, several European observatories had their own limited facilities in the southern hemisphere, most of them on the premises of South African observatories, and extensions of these were under consideration. Belgium, the German Federal Republic, Ireland and Sweden participated in Harvard Observatory's Boyden Station at Bloemfontein; Leiden Observatory had its southern station on the premises



*Walter Baade (left) in characteristic pose, talking to C. Schalén of Sweden.<sup>1</sup>*

of the Union Observatory, first at Johannesburg and later at the field station at Hartebeespoortdam; British astronomy had close relations with South Africa through the Radcliffe Observatory at Pretoria and the Cape Observatory near Capetown. Rather than enlarging these facilities, one should pool resources and efforts, and strive for equipment comparable in research power to that of the large Californian observatories that had for decades dominated observational astronomy. (All reflectors with aperture of 80 inch or more were located in the northern hemisphere [6]).

<sup>1</sup> The photographs accompanying this chapter were taken by the author during a boat trip on one of the days of the Groningen Conference in June, 1953, immediately after the idea of a joint European Observatory had been discussed for the first time by a group of astronomers at Leiden on June 21. Purpose of the trip were the reclamation operations in the area of the former Zuiderzee, now the domain of large, flourishing farms. All of the participants at the Leiden meeting joined in the boat trip, and the notion of a joint observatory must have been one of the hotter subjects.

Moreover, some of the most interesting objects of research could be reached only from the southern hemisphere: the central parts of the Galaxy and the nearest extragalactic systems. Baade stressed the growing importance of extragalactic work and the fact that only by means of a large telescope Europe might hope to join in it. In addition to the two instruments mentioned, the meeting proposed a meridian circle for the astrometric work that also was much needed in the southern hemisphere. That South Africa was envisaged for the location, was almost self-evident also because it had the best astronomical climate known at that time. The minutes of the meeting contain a provisional cost estimate. Capital investments were estimated at \$ 2.5 million, and annual running costs at \$ 100,000.-. These included salaries for 3 astronomers, 5 technical personnel, 3 night assistants and 3 administrative posts. Participants of the June 21 meeting were invited to discuss these plans with their colleagues at home.

The results of their deliberations were discussed at the meeting of January 1954 mentioned at the beginning of this chapter [7]. It was chaired by Bertil Lindblad and held in the stately Senate Room of Leiden University, where portraits of scientists of Leiden's illustrious past, looking down on the participants, may have inspired their historical statement. The statement reflects the positive response they brought from their colleagues at home. The meeting decided to form an ESO Committee to carry the project further, consisting of Bourgeois (Belgium), Danjon (France), Heckmann (German Federal Republic), Spencer Jones (Great Britain), Oort (Netherlands) and Lindblad (Sweden). The suggestion was made that some intermediate size telescopes should be added to those mentioned earlier. An improved cost estimate was presented: capital investments should be 1.25 million pounds (then corresponding to about \$ 3.5 million), based on preliminary offers from European manufacturers, and an annual budget of 45,000 pounds (corresponding to about \$ 126,000). The project was envisaged to be realized over the next ten years. The meeting was aware that this financial support might be very hard to obtain from research councils or governments, but the suggestion was made that perhaps this might be facilitated if funds from private foundations or societies could be added. It was also realized that the project would need a convention between learned societies or between governments; the former was preferred (but would later have to be abandoned for the latter).

Next steps were taken at the Committee meeting of November 1954 in Paris, chaired by Oort, the principal subjects being the drafting of the convention and site testing in South Africa [8]. Beginning with this meeting, these two subjects determined the two main lines of the Committee's activity. Later on, a third would be added: the planning of the instrumentation. Of these three lines of activity of the first decade, we shall first follow developments leading to the Convention and Ratification, next describe the site





*From left to right: V. Kourganoff (France), J.H. Oort (Netherlands), H. Spencer Jones (Great Britain).*

testing expeditions, and subsequently the first planning of the instrumentation.

In these first years the Committee had no permanent President or Secretary. It met in various astronomical centres and usually was chaired by the host, for instance by Heckmann in Bergedorf and by Lindblad in Saltsjöbaden, until at the October 1957 meeting it made Oort its President and Bannier its Secretary and Treasurer. In May 1959 I succeeded Bannier as Secretary.

### **Towards the Convention**

A first proposal for the Convention, between organizations, was drafted for the November 1954 meeting by Bannier and Funke [9]. G. Funke, Secretary of the Swedish Natural Science Research Council, was, like Bannier, a member of the Council of CERN. Amendments were made to this draft, but on the whole the matter of the Convention proceeded slowly during the first years. Little of what happened within the participating countries filters through in the minutes of the Committee meetings, until in 1960 the matter comes into focus again. In its meeting of July of that year, held in Heidelberg, the ESO Committee discussed in detail a new draft; it still was one between organizations, but its author, Bannier, stressed the necessity of a convention between governments [10].

What had caused this change, and at the same time made the matter rather urgent, were the sharply increasing costs of the site testing expeditions in combination with plans for modest observational programmes which, apart from contributing to the site testing, would produce scientific results. They will be discussed in the section on the testing programmes. Over the whole year 1959 and half of 1960 the total budget for the site testing and other expenses had been only \$ 32,346.-. For the following one year and a half, however, a total of \$ 363,000 had been estimated. Of this, France and Germany were supposed to contribute  $\frac{1}{3}$  each, and the three smaller continental countries about  $\frac{1}{6}$  each; the chances of Britain's participation having become quite small already at this stage. Whereas, so far, the financial resources had come from national science research councils or equivalent bodies on a year-to-year basis, these new estimates called for commitments at higher, government level.

The new draft was largely adapted from the CERN Convention. Although ESO is, of course, in essential aspects different from CERN, especially because it has its principal establishment, the Observatory, outside Europe, its constitutional set-up, its financial basis and its personnel regulations have become very similar to those of CERN through this early adaptation of the CERN model. At the same time, this similarity has often led governments to appoint on the ESO Council the same delegates as on the CERN Council, resulting in similar policies.

Some features that have marked the drafts from the beginning are worth noting here: Every participating country would be represented on the ESO Council by two delegates, of which at least one should be an astronomer, and each member has equal vote – although in practice, of course, opinions of the largest countries carry strongest weight. Financial contributions are proportional to the national income but only up to a fixed limit, so that excessive domination of one member is avoided. The convention also stated from the beginning that the observatory should be located in the southern hemisphere, no broader geographical choice was ever seriously considered. As to the equipment of the Observatory, there is the first set-up with the large optical telescope and the Schmidt telescope referred to before, but this is called the initial programme and the Convention allows in principle extension with any kind of other instrumentation, whatever frequency domain of the electromagnetic spectrum it may cover.

What slowed down the signing of the Convention was not any serious disagreement concerning its contents, although there had been quarreling about details – the fact that CERN successfully operated on a very similar basis was helpful – but rather the fluctuating and sometimes very low expectation with regard to the governments' willingness to embark upon this project in times of deep financial problems. Naturally, in this respect there was a large difference between CERN and ESO: development of nuclear



*O. Heckmann (left, German Federal Republic) in discussion with B.J. Bok (United States).*

physics being a must in the post-war era for virtually every nation, in contrast to the apparent lack of usefulness of promotion of the study of the sky. An additional, serious drawback was the gradual withdrawal of Great Britain.

### **Withdrawal of Great Britain**

At the April 1956 meeting of the ESO Committee Great Britain was still represented by R.O. Redman and R.v.d.R. Woolley [11]. The latter succeeded Spencer Jones as Astronomer Royal in 1956. At the April 1957 meeting Redman was present, but after this, several years would elapse before a British astronomer appeared again. British interest turned towards a Commonwealth Observatory in Australia, in preference to the ESO project. However, the attitude was not univocal. Thus, in a letter of May 13, 1959 Redman informed Oort that there had been *“a rather unexpected swing of opinion among a number of astronomers and physicists in this country – – –”* [12], and in July 1960, Sir William Hodge, Secretary of the Royal Society, wrote to Oort: *“You have no doubt heard that the British National Committee for Astronomy has been giving fresh consideration to the possibility of taking part in an international effort to construct a 120” telescope in the southern hemisphere – – –”* [13].

Later that month, on the 27th, Woolley informed Oort more specifically: *"The British National Committee prefers participation in a Commonwealth telescope to participation in a European telescope, but would favour participation in a European telescope if it is not possible to organise a Commonwealth telescope. ---"* [14]. Moreover, Woolley stated, they *"--- would only favour support in any scheme if the result of the participation was an allocation of telescope time, proportional to share taken of the expenses --- and if the affairs of the Observatory --- were vested in the hands of a Council, on which voting strength was again proportional to the financial share borne by each nation."* Clearly, on these latter points British views diverged from those among the ESO partners. These points might have become the subject of further negotiations, but that stage was never reached.

In spite of the divergence between British and continental views and intents, British authorities were regularly kept informed on developments regarding ESO. They continued to be invited to the meetings of the ESO Committee. It also happened through other channels, for instance in correspondence between Bannier and the Office of the Minister for Science at Whitehall, notably in an extensive letter by Bannier of February 3, 1961 [15]. At the January and June 1961 meetings of the ESO Committee Great Britain was represented again, by Woolley and O.J. Eggen, and at the November 1961 meeting by A. Hunter. Meanwhile, another link had been established through which British astronomy was kept informed: the meetings of ESO's Instrumentation Committee were attended by a representative of the Astronomer Royal, first by Eggen, later by Hunter [16]. After 1961 no British representative attended the meetings of the ESO Committee any more.

### **The Grant of the Ford Foundation**

Whereas the withdrawal of Great Britain had seriously weakened the basis for the ESO project, there appeared at least one bright spot above the horizon. As mentioned before, the possibility of financial help from non-government funds was alluded to in an early stage. I remember – but this is not documented – that on the occasion of a visit to the southern Leiden Observatory Station in the 1950's, Oort explored the possibility of financial help from within South Africa, but that it failed because of lack of support from certain astronomical sides in the country. On the other hand, the case of ESO has much benefitted from a grant allocated by the Ford Foundation which has its seat in New York. This foundation was well known for its promotion of international collaboration on a world-wide scale.

After an early approach by Oort had not met positive reaction, a renewed application led to the Foundation's decision in October of the year 1959, to allocate a grant of one million dollars under certain conditions, the most



*From left to right: Mrs Mieke Oort (Netherlands), B. Strömgren (Denmark) and B. Lindblad (Sweden).*

important of which was, that at least four of the five nations still positively involved at that time, Belgium, France, the German Federal Republic, the Netherlands and Sweden, would sign the Convention [17]. This condition was in full harmony with what had become common understanding anyhow – that participation of four countries would be a minimal base for further pursuing the effort. In order to fully appreciate the significance of the Ford Foundation's grant, one should realize that at that time the estimate of the capital investment required for the establishment of the observatory used to be \$ 5 million [18]. The grant thus was equivalent to the average of the five countries' shares, and thereby had the character of pushing the project financially over the threshold in the case of stagnation of one of them. The amount also happened to cover approximately the cost of the mirror blank of the large telescope.

There can be little doubt that the grant has been most beneficial for bringing the negotiations between and within the countries mentioned to a successful end. A letter of Oort to Dr. C.W. Borgmann, Director of the Science Programme of the Ford Foundation, of April 22, 1960 testifies to this in connection with the Dutch government's decision to participate [19], and so does Heckmann's account on the early ESO history in his introduction to

the Annual Report of ESO for the year 1964 [20], as well as in his book *Sterne, Kosmos, Weltmodelle* [21]. The grant was transferred to ESO soon after the ratifications had been completed, on September 21, 1964 [22].

The history of the grant of the Ford Foundation has recently been the subject of an investigation by F.K. Edmondson. A summary, kindly offered by Dr. Edmondson is presented in Annex 2 at the end of this book.

### **Founding Fathers**

The archival documents of the last years of the 1950's and the early 1960's reflect the extremely difficult political circumstances under which especially the French adherence had to be gained. This was the more serious because from the outset it had been agreed that the initiative for convening the representatives of the member states for the signing of the Convention – their ambassadors – should be with the French government [23]. Under the still delicate political circumstances of those years this seemed natural from a diplomatic point of view. It is also to be understood in this context, that the basic text of the Convention should be the French one, particularly after the withdrawal of Great Britain [24].

Most of the French governments of those years were short-lived as a consequence of internal political division of the country, and on top of this, the Algerian independence movement made great demands on the successive cabinets from the year 1954 until independence was agreed in March 1962. The other major partner in the ESO effort, the German Federal Republic, went through its “economic miracle” in these years and seldom posed financial problems. Naturally, it was aware that a positive attitude with respect to matters of European integration should help bridge the cleavage caused by the war. In the smaller partner countries, however, post-war rebuilding programmes drew heavily on financial resources and made governments hesitant to commit themselves to a long-term financial obligation in astronomy.

Whereas the project was the subject of frequent consultation between many astronomers mutually and with their governments, there are three persons who, due to their key position, emerged as the principal spokesmen in the international discourse. They were: Jan H. Oort who as initiator and deeply convinced of the necessity of the project constantly strived for its realization; André Danjon of Paris, leading French astronomer and also strong supporter who had the difficult task of attaining his government's approval; and Otto Heckmann, one of the leading German astronomers, Director of the Hamburg Observatory and one of the strongest advocates of the project in his country. He would become ESO's first director. More in the background, but not to be forgotten, were such men as Bertil Lindblad (close to Oort by personal friendship and similarity of research interests),

Charles Fehrenbach of Marseilles (close to Danjon), J.H. Bannier and G. Funke, to mention a few. Deeply interested in the developments was also Pol Swings of Liège, but a certain lack of communication between Belgian astronomical centres at that time has hampered Swings' full involvement [25]. Without the growing mutual respect and friendship between the people mentioned here, the ESO project might not have surmounted the many obstacles on its way towards realization. The correspondence between these men (telephone and cable messages played only a minor role in these days) sometimes was of a strong personal nature and represents a touching "document humain". Not all letters are type-written, nearly all of Danjon's letters in the ESO Archive are handwritten.

Not all of these Founding Fathers have lived to see the dream realized. Walter Baade died already on 25 June 1960, and Bertil Lindblad on 25 June 1965, a little more than a year after the ratifications had been completed. André Danjon died on 21 April 1967, only shortly after ESO's first constructions on La Silla had begun.

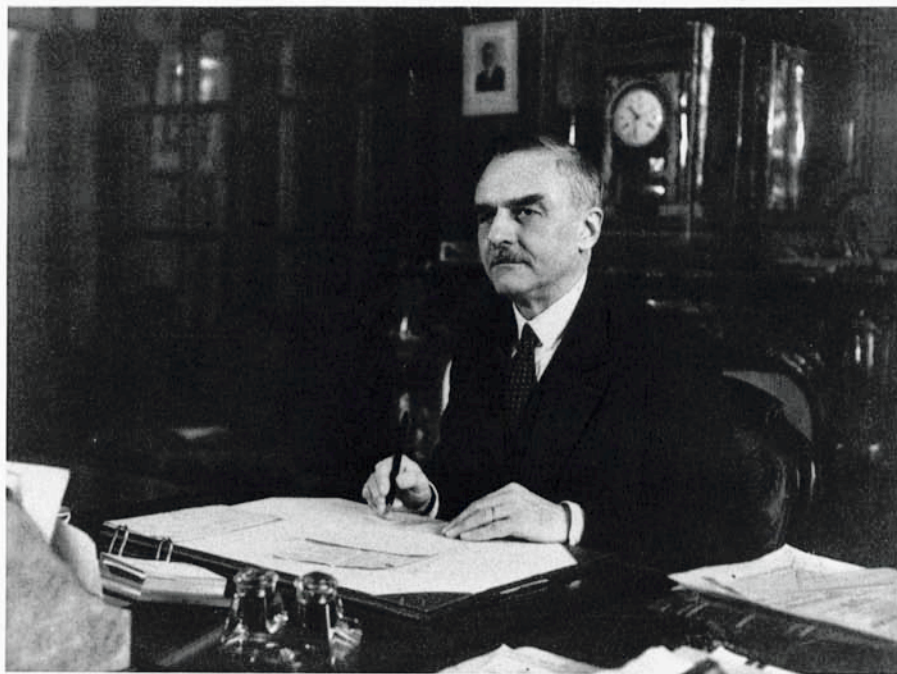

*André Danjon (6 April 1890 – 21 April 1967). Photograph by Jacques Boyer, kindly made available by Paul Danjon through the intermediary of Observatoire de Paris.*

## The Final Struggles

By the middle of 1957, the chances for approval of the project by the French government were very low. Summarizing a discussion with Heckmann on August 26 of that year, Danjon wrote that he feared opposition to the project by the Ministry of Finance [26]; it even seemed impossible to obtain funds for the site tests of the years 1957 and 1958. Danjon nevertheless thought that the project should be pursued, with France possibly joining at a later stage. Under these circumstances, serious consideration was given to a German financial guarantee to save the project and yet retain broad international character [27], a suggestion that received support from the German astronomical community [28]. The meeting of the ESO Committee of October 1957 drafted alternative budgets for the cases with and without France [29]. The German guarantee was not really effectuated, but the situation remained gloomy.

When the ESO Committee met in October/November 1958 in Uccle, there was no French representation; Danjon and Fehrenbach requested to be excused because their country seemed to be unable to help support the site-testing [30]. The other countries decided to go on, but the situation underlined once more the urgency of arriving at the binding international contract. It would take another year for chances to become better.

In a letter to Oort of 6 November 1959, Danjon could write: "*Enfin, le mouvement est déclenché. ---*", after having received an invitation for a discussion between high officials of the Ministries of Sciences and Finances [31]. This move had very likely been prompted by the Ford Foundation grant of preceding October. In letters of 10 and 12 December, Danjon sounded quite optimistic about both the fundamental decision for participation and the financial prospects: "*J'ai en effet indiqué au gouvernement que, compte tenu de la Subvention Ford, la dépense des 5 pays de l'Europe Occidentale serait de 4 millions \$, à répartir sur 8 ans, et que, tant que d'autres pays n'auraient pas décidé de participer à la réalisation du projet, la France devrait en couvrir 1/3. --- J'attends avec impatience le retour du gouvernement, qui est à Dakar. J'espère que la décision officielle de la participation sera prise et que les invitations seront lancées. ---*" [32].

On January 12, 1960, Danjon wrote to Oort that the Prime Minister had issued letters to the Ministries of Finances and Foreign Affairs, and the ESO project was to be submitted to the coming Cabinet Council [33]. And "*La démission du Ministre de l'Education Nationale nous aura fait perdre 1 mois entier, mais maintenant, les choses en sont au point où seule, une crise du gouvernement pourrait les compromettre. ---*". On February 1, Oort, not yet having heard from France, enquired discretely whether the Dutch Ministry of Foreign Affairs might now expect soon to be approached [34], and he may have drawn hope from Danjon's message that Dr. Sheppard



Stone, Director of International Affairs of the Ford Foundation, one of these days would take up the matter of ESO with the new French Minister of Education [35]. But then, when by the end of the month Oort has not yet heard the good news, the correspondence between the two friends takes a dramatic turn. On March 1, Oort writes to Danjon [36]:

*“Mon cher ami,*

*Je viens de passer une demie nuit sans sommeil avec mes soucis concernant l'ESO. La responsabilité pour ce projet pèse un peu lourd. --- Pourquoi est-ce qu'on nous fait tant attendre? Votre ministre ayant pris la décision de principe, pourquoi ne peut-on pas prendre aussi la décision ferme de participer, de sorte que nous puissions commencer? --- Vous comprendrez sans doute que je m'inquiète et que je commence à perdre le courage. --- Je regrette, mon cher ami, que je dois ainsi vous faire part de mes soucis. ---”*

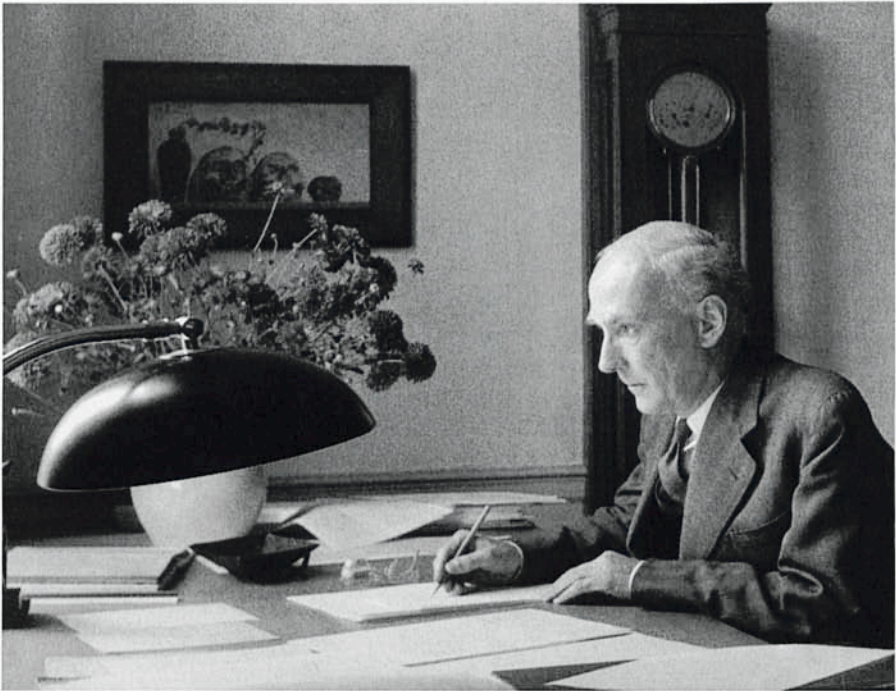

*Jan Hendrik Oort, born in 1900; photograph by Herman Kleibrink, taken in 1953.*

In reply, Danjon immediately writes, on March 3, 1960 an unusually long letter which seems to describe the situation so well that I like to quote it in full [37]:

*"Mon cher ami,*

*Croyez bien que je partage votre inquiétude et que je ressens vivement la responsabilité de la France dans les ajournements successifs du projet. J'ai été tenté plus d'une fois de vous écrire que je renonçais à m'en occuper, mais je suis persuadé que votre tâche ne serait pas facilitée par le retrait de la France, lequel en entraînerait d'autres. Quant à faire des démarches, il m'est impossible de m'y consacrer plus que je ne le fais. Au mois de décembre, j'ai vu une dizaine de fois une personne du Cabinet du Ministre, qui avait tout préparé pour que l'affaire soit soumise au Conseil des Ministres. Mais M. Boullouche, le Ministre de l'E.N. [Education Nationale] a donné sa démission vers Noël, pour des raisons de politique intérieure. D'autres motifs ont déterminé le départ du Ministre des Finances et retardé la désignation du nouveau ministre de l'Education. Alas est survenue la révolution d'Alger dont vous n'avez peut-être pas évalué les répercussions sur la vie publique en France. Le nouveau ministre, M. Joxe, que je connais bien, n'a pas pris ses fonctions immédiatement, car il était engagé dans de difficiles négociations avec les républiques noires d'Afrique. Il n'y a guère plus de 3 semaines qu'il a constitué son cabinet. Or il a à résoudre les problèmes insolubles qui ont causé la démission de son prédécesseur! Cependant, au cours de l'intérim, j'ai pu obtenir que le Premier Ministre écrive aux Affaires Etrangères et aux Finances. J'ai vu le Ministre vendredi 26 février. Dès le 8 février, j'avais fait rechercher le dossier de l'ESO, et M. Berger en avait entrevenu le Ministre. Je suis retourné au Ministère les 29 février et 2 mars, pour prendre contact avec un membre du cabinet qui venait de recevoir le dossier. Il fallait l'informer de l'affaire, toute nouvelle pour lui. Ce matin, j'ai eu une autre conversation avec M. Piganiol. A tous, j'ai affirmé la nécessité pour la France de prendre une décision.*

*Croyez-vous que j'aurais pu faire davantage? Toute personne approchant du gouvernement se rend bien compte qu'il est obsédé par l'Afrique du Nord et non par l'Afrique du Sud. Soyez assuré, mon cher ami, de ma constante et fidèle amitié,*

*A. Danjon"*

From letters of Fehrenbach and Danjon in the months following, it appears that, while a decision in principle by the French authorities had been taken, executive action was further delayed by the instabilities within the government. Towards the middle of the year 1960 Danjon wrote to Oort: " — — — *La lourde machine administrative — — — dépend de 4 ministères dont 3 ont changé depuis le début de l'année! J'ai l'impression d'être condamné à rouler le rocher de Sisyphé pour l'éternité! Mais j'ai tout de même très bon espoir.*" [38].

About that time, in correspondence between Oort and Heckmann preparing for the Committee meeting of July 15, 16, 1960, the possibility of German advance financing was taken up again, combined with a Dutch initiative for convening the five governments [39], but this did not appear to open promising perspectives. However, towards the end of the year 1960 French authorities occupied themselves with the formulation of the text of the Convention, and of the Financial Protocol that belongs to it, so that these texts could be discussed at the meetings of the ESO Committee and presented to the Foreign Ministries of the partner countries [40].

Further delay was then caused by difficulties in arriving at an acceptable text of the German version of the Convention. Towards the end of 1961 it was the general impression that universal agreement had been reached, but then unexpectedly a new dispute arose between German and French officials on the interpretation of the Convention text concerning the distribution of the contributions of the member states. By the end of March 1962 Heckmann



*Bertil Lindblad (26 November 1895 – 25 June 1965). Photograph dating from the 1940's, kindly made available by P. O. Lindblad.*

had also removed this obstacle [41]. At the June 1962 meeting of the ESO Committee in Bruges, Belgium, it could be announced that the date for the signing was approaching. And on September 21, 1962 Danjon wrote to Oort [42]:

*“Mon cher ami,*

*Les Affaires Etrangères ont fixé au 5 octobre la signature de la Convention. Enfin! — — Je ne saurais vous dire combien je suis heureux de voir enfin prendre corps votre grand projet. Mais il aura fallu plus de dix ans! L’astronomie est bien l’école de la patience. — —”*

The Convention was indeed signed on that date, at the Ministry of Foreign Affairs in Paris, for the foreign countries by their ambassadors and for France by the Secretary-General of the Ministry of Foreign Affairs. That same date, Danjon wrote to Heckmann [43]:

*“Mon cher Collègue,*

*Un mot seulement, pour vous confirmer que les représentants des 5 pays ont signé la Convention aujourd’hui à Midi! Alleluia!*

*Bien cordialement votre*

*A. Danjon”*

After this memorable event, it would still take more than one year before the Convention would be ratified and thus governments could assume financial commitments. As it is stated in the Convention, this situation would be reached when at least four of the governments had ratified and, moreover, these four would represent at least 70% of the total of the contributions. This implied that in any case France and the Federal Republic of Germany should be included. It was accomplished when France ratified on 17 January 1964 [44]; the Netherlands had ratified on 21 March 1963 [45], Sweden on 4 November 1963 [46], and the German Federal Republic on 10 November 1963 [47].

So, then, from early 1964 on, ESO was on solid grounds and could begin realizing its long-term building project. It would within a few years do so on an even broader base, after Belgium had ratified on 2 October 1967 [48] and a sixth member, Denmark, had even done so a little earlier, on 23 August 1967 [49]. But before we enter this new phase, we describe in the following chapters what meanwhile had been accomplished in the search for the site of the Observatory and in the preparations for its instrumentation.

## II. SEARCHING FOR A SITE IN SOUTH AFRICA

*“--- observers are on duty from sunset till sunrise ---.”*  
From André Muller's instructions for the site tests, December 1960.

### Introduction

Over a time span of more than seven years, with several interruptions from late 1955 to the middle of 1963, young European astronomers and their assistants were engaged in the search for a site in South Africa. By the end of that time, it became clear that the observatory would not be built on this continent; the South American Andes Mountains offered superior observing conditions.

Does it make sense, then, to devote a full chapter to the South African explorations? It does – not only because we want to do justice to the large effort made by many young astronomers and their assistants, but also because the South African venture was ESO's first exercise in European collaboration.

### First Impressions

Already in January 1954, at the second meeting of the ESO Committee (henceforth to be denoted by EC), the question of the best site for the observatory was taken up. As I explained in the previous chapter, the southern part of Africa seemed a natural choice. However, the observatories in South Africa were all located in, or near, major cities or communities: the Cape Observatory, the Union Observatory – originally only at Johannesburg but later having its field station at nearby Hartebeespoortdam –, the Boyden Observatory near Bloemfontein, and the Radcliffe Observatory near Pretoria. This latter observatory had been created rather recently, in the early 1930's, as a result of the transfer from Oxford; yet also in this case proximity to a major city had been chosen, even for the planned 74-inch telescope [1].

For ESO, vicinity of a major centre of civilization was not an important criterion, and so, the EC decided to start from scratch. Needed was, of course, a place with a minimum of cloudiness and as free as possible from smoke and sky illumination. Moreover, astronomers want good “seeing”. By this they mean, that the image of a star as observed in a telescope should

show minimum distortion due to turbulence in the earth's atmosphere. This question of "seeing" is explained in some more detail in the box accompanying this chapter.

Apart from the experience collected over the years by the existing observatories, there was little the EC could go by. There was an interesting report by B.J. Bok of August 1953, dealing with a comparison of conditions at Harvard Observatory's Boyden Station in South Africa and its Agassiz Station in Massachusetts [2], in which Bok drew attention to what seemed to be a general characteristic: "*All over the High Veld of South-Africa, with its remarkably clear and pure skies, the seeing deteriorates often about midnight or shortly after, with no recovery before dawn ---. The after-midnight deterioration of seeing happens as well at the Union Observatory in Johannesburg, at the Radcliffe Observatory near Pretoria and at the Lamont-Hussey Observatory on Naval Hill in Bloemfontein. ---.*"

Also of historical interest is an extensive letter by Walter Baade to Oort of 1 November 1954 [3]. That Baade's opinion would carry much weight is obvious: his fundamental discovery of the different stellar populations had been possible by a combination of two special circumstances at Mt. Wilson Observatory some time during World War II: a sky free of illumination by the neighbouring city of Pasadena, and exceptional seeing conditions at the 100-inch during the photographic exposures of the Andromeda Nebula and its satellites.

Baade's letter stressed the importance of local conditions: "*--- I have no experience with the conditions on high plateaus such as that in South Africa but I am strongly inclined to believe that there, just as in Southern California, the seeing during the best observing season is largely determined by the air layers close to the ground ---. Local topological conditions therefore must play a role ---.*" Baade also stressed the importance of correlating the rating of the seeing as judged in the test instrument with that observed in a large reflector, and suggested that the Haute-Provence Observatory, favoured with good seeing, might be a suitable place for such comparison.

At the request of the EC, meteorological data on South Africa were collected and discussed by Siedentopf of Tübingen [4]. He concluded that the High Veld, the semi-desert plateau stretching from Johannesburg to Bloemfontein and southward, should offer the most favourable over-all conditions. The EC meeting of November 1954 therefore decided to first explore the Pretoria-Johannesburg and Bloemfontein-Kimberley areas, with limited tests in the Beaufort West region located further south. In each of the first two a fixed observing post was to be chosen near the existing observatory, to serve as a reference point, and the surroundings were to be explored with a moving telescope.

At a meeting in March 1955 in Uccle, details of the project were discussed by Bourgeois, Danjon, Heckmann, Spencer Jones and Oort [5]. A classical

## Astronomical "Seeing"

Under ideal atmospheric conditions, the image of a star as seen in a telescope consists of a bright central spot surrounded by a weak circle, the diffraction ring. This is due to the wave character of the light in combination with the fact that the telescope objective or mirror cannot but be of limited size. If the atmosphere is disturbed by turbulence, then (a) the ring is broken up and both it and the central spot lose their sharpness, and (b) the whole image of the star moves rapidly, in an erratic manner. The combination of these two effects determines the quality of the image, called *seeing* by the observer. The less turbulent the atmosphere, the better is the seeing. Hence, astronomers can judge seeing by the quality of the appearance of the diffraction ring, and by the degree of violence of the motion of the bright central spot, called the "image motion".

Estimates by the appearance of the diffraction ring are not easy to put on a quantitative basis; observers use a scale of ratings mutually agreed upon and to be checked regularly. The Danjon telescopes, equipped with mirrors of 25 cm, produced a suitable size of the diffraction ring and gathered sufficient light to make it well visible for bright stars. Normally, the estimates were not seriously hampered by the image motion.

Judging the seeing by the image motion has the advantage of allowing a quantitative measurement, for instance the average deviation of the central spot from its mean position. It has the disadvantage of requiring very stable mounting of the telescope. There is, however, a way around this: one fixes two telescopes on one sturdy mounting and by means of an optical device arranges for the two fields of view to be seen superposed on each other. Measurement of the relative displacement of the two central spots is then a measure of only the atmospheric effect because the shaking of the mounting affects the two in the same manner.

There is still a third method that helps measuring the seeing. In a turbulent atmosphere, we can distinguish turbulence cells, somewhat vaguely defined units which move with respect to the surrounding medium. Such cells differ slightly in temperature with respect to this medium. As a consequence, if one measures the temperature at a fixed point above ground level – for instance at the top of a fixed pole – then one will find rapid fluctuations as a consequence of the successive passages of the cells and the surrounding medium. The more turbulent the atmosphere, the more violent the temperature fluctuations. Experiments have shown that the degree of violence is closely correlated to the rating of the seeing by the diffraction ring method or by the image motion. Conversely, measures of the temperature fluctuations can tell us whether we may expect to observe with good, or with bad seeing.

method was chosen for the evaluation of the quality of stellar images: the appearance of the diffraction rings as observed in a small reflector. In the accompanying box we explain some of the ways in which the astronomer can evaluate the quality of the stellar images. The method selected had been described by Danjon and Couder in their textbook *Lunettes et Télescopes* of 1935 [6]. Four azimuthally mounted reflectors of 25 cm aperture were built for the project at the Paris Observatory. For the measurement of the atmospheric extinction, photo-electric observations were to be made at wavelengths about 4500 and 5300 Å, with small refractors. Moreover, of course, cloudiness, wind velocity and wind direction would have to be recorded.

## II. SEARCHING FOR A SITE IN SOUTH AFRICA

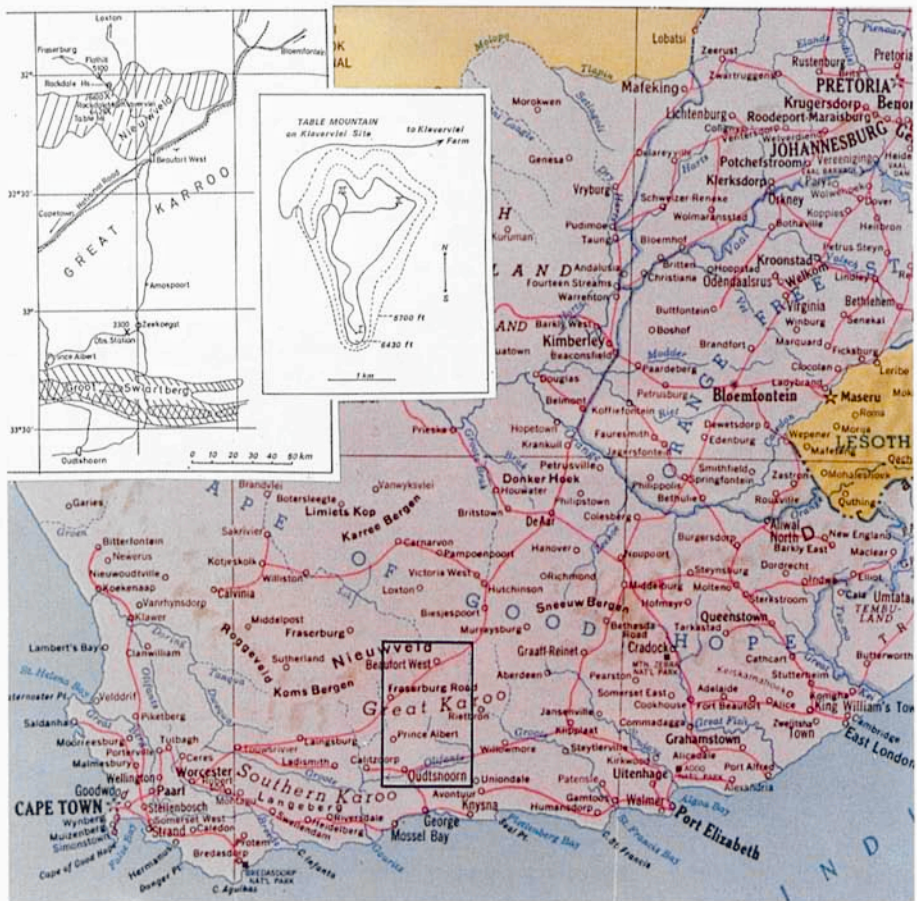

**Map of South Africa.** The ESO site tests over the years 1955–1963 covered the area from around Pretoria-Johannesburg to the Great Karoo near the south coast, and during the last years concentrated on the region marked with the rectangle. This region is shown in blow-up in the upper left corner, adapted from the report by Ursula Mayer mentioned in the text. The site testing station near Zeekoegat and the three on Klavervlei Farm: Table Mt., Rockdale Mt. and Flathill are marked by crosses. The blow-up of Table Mt. on Klavervlei Site shows the three locations investigated by the Quick-Look expedition in early 1961.



A detailed and systematic account on the techniques applied and on the site tests over the first two years, 1955–1957, “Le projet de création d’un observatoire européen en Union Sud-Africaine”, has been published by one of the first participants, J. Dommaget [7].

The first observers left in October 1955 by boat: G. Courtès from France, J. Dommaget from Belgium, H. Elsässer from the German Federal Republic, and Ch. E. Heynekamp from the Netherlands. They arrived in Capetown on November 6. An extensive letter by Elsässer and Heynekamp to the spiritual father of the project, J. H. Oort, of 17 January 1956, also reports on the beginning of their activities [8], and Elsässer described the early work in *Die Sterne* **33**, p. 3, 1957. First observations for intercomparison of all observers were made in the Bloemfontein area in December 1955. Subsequently, the work was divided over the northern (Johannesburg-Pretoria) area and the southern one (Bloemfontein).

On the basis of this first reconnaissance, the EC meeting of April 1956 decided to drop the Johannesburg-Pretoria area and concentrate further work on the region of Bloemfontein and farther southward down to the surroundings of the village Oudshoorn. This is located close to the Swartberg mountain range at the southern border of the Karroo semi-desert. J. Boulon from France replaced G. Courtès for this second phase, which was reported at the October 1956 meeting of the EC by Danjon and Siedentopf. The Karroo emerged more and more as the most promising region, so that the EC decided to extend testing there, in particular near the settlements Zeekoegat and De Aar-Koffiefontein. A new team of observers replaced those mentioned before: F. Bertiau from Belgium, and K. Rohlf and J. W. Tripp from the FRG. They embarked upon a year’s programme to be completed by September 1957. A joint interim report of March 23, 1957 submitted to the chairman of the EC [9] gives first observational results, but also reflects some concern about the problem of systematic differences between the results of different observers, the relevance of tests made with small telescopes for work done with large telescopes, the possible influence of local seeing-disturbing elements, etc. Nevertheless, the Zeekoegat area began to seem superior to the other ones investigated.

After the completion of this mission in September 1957, the work done over the years 1955–1957 was reviewed in a meeting on 9–11 January 1958 at the Paris Observatory by a group consisting of Danjon, Heckmann, Fehrenbach, Couder, Dommaget, Guinot and Tripp, which led to a re-analysis of the data by Tripp [10]. This was first prepared for the July 1958 meeting of the EC and, in more complete form, for its October/November meeting. It confirmed the favourable impression of the Zeekoegat site, with Tafelkopje, a hill near Bloemfontein, as a close second. However, as the report pointed out, the analysis suffered from systematic differences between the evaluations obtained by different observers at different places and between obser-

## II. SEARCHING FOR A SITE IN SOUTH AFRICA



### **EARLY SITE TESTING IN THE KARROO REGION**

*Between October 1955 and March 1957, first series of site tests were performed over a wide range of geographic latitudes in South Africa, gradually converging to the Karroo semi-desert region. They have been described in much more detail than in the present account by one of the principal participants, J. Dommanget [7], from whose photographs donated to the EHPA these two have been selected. They show (above) the observing post on the Rooiberg hill near Calitzdorp in the southern Karroo, with a Danjon telescope equipped with a Walraven refractor-photometer, and (below) Dommanget's collaborator J. Boulon, at Willomore, with the equipment as it was moved between different observing sites.*

variations made with different telescopes, notwithstanding the careful measures taken to eliminate these effects. A report by Dommanget on the first years of ESO's tests in South Africa was presented at the IAU Symposium on site testing held at Rome in 1962 [11].

### **Adding Some "Real" Astronomy**

A new phase of more rigorous investigation in the Karroo developed in the second half of 1958. It envisaged, apart from continuation of work with the Danjon and photo-electric telescopes, some real research programmes. A suggestion for such broadening had been made by Danjon at the July 1958 meeting of the EC. Doing "real" astronomy would help testing the site and make it more attractive for young astronomers to become involved in the work. Two projects presented themselves for this purpose.

The Marseilles Observatory, directed by Fehrenbach, had developed plans for the erection in South Africa of a duplicate of the objective-prism refractor of 40 cm aperture of the HPO, the so-called GPO (Grand Prisme Objectif) for determining radial velocities [12]. Initially, a location near the village Prince Albert had been considered, but now an alternative was contemplated: one of the possible sites for the ESO project. The operation would become more expensive for logistic reasons; the additional costs might then be absorbed by the site testing project [13]. The solution also would strengthen the effort for

integration of France in the ESO project. At this time the French participation in ESO was still quite uncertain.

A second suggestion had been made by myself on behalf of the Kapteyn Laboratory: it proposed photo-electric photometry of moderately faint stars, providing information on the photometric quality of the site as a by-product. As it turned out later, this project could not be realized, but a similar one was done by the Tübingen programme of Siedentopf described below.

These suggestions were submitted to the October/November 1958 meeting of the EC [14], at which also another step was taken up: an evaluation of building costs, technical expertise, acquisition of water and power supply, etc. in South Africa. These were to be investigated by a "technical" group consisting of the engineer B.G. Hooghoudt (responsible for technical developments of radio astronomy in the Netherlands), Fehrenbach and myself, together with the German astronomer H. Haffner who at that time resided at the Boyden Observatory. The group arrived in South Africa on 16 March 1959 and stayed for about five weeks, after which it reported to the EC meeting of May 1959 [15].

The report led to a somewhat modified approach. Further testing of the Zeekoegat area was recommended, but attention was also to be given to sites at considerably higher elevation than those explored so far. Such sites were to be found on the Nieuwveld Plateau north-west of the village Beaufort West. On the other hand, no further testing of the region around Bloemfontein was to be done. Reasons for its exclusion were the fear for growing disturbance by city lights, and seasonal effects in the climate which are unfavourable for observing the Magellanic Clouds.

Henceforth, interest focussed mainly on two possible locations: the vast territory of Klavervlei Farm on the Nieuwveld Plateau, where contacts with the owner, R. Köster, had been established by the "technical" group; and Zeekoegat, where the same had been done with the owner Miss M.E.Z. Oosthuizen of the Farm Sunnyside. Klavervlei Farm was located about 35 km north-west of Beaufort West, and Zeekoegat about 80 km south of this town. Ultimately, three mountain spots on Klavervlei Farm became the subject of intensive tests: Table Mountain at elevation about 1,970 m, Rockdale Mt. at 1,860 m, and Flathill at 1,490 m. They are indicated on the accompanying map.

The Zeekoegat site was located at elevation about 1,000 m, only slightly above the surrounding plane. In a way, the two kinds of sites represented two different philosophies: in the Klavervlei area, the mountain-top concept embodied by the Californian observatories; at Zeekoegat the concept of the French Haute-Provence Observatory – only slightly elevated above its surroundings – which reminds us of the description at the end of the chapter on image quality in Danjon and Couder's *Lunettes et Télescopes* referred to before: "*D'une manière générale, il convient de rechercher de préférence les*

*plateaux secs d'altitude moyenne, loin de la mer ou des grandes vallées, couloirs de vent. Il est superflu d'avoir un horizon dégagé, car un observatoire astronomique n'est pas un point de vue. ---*

### **The Quick-Look Expedition**

In order to get a first impression of the Nieuwveld Plateau, one of the Klavervlei sites, Table Mt. was explored by a three-month "Quick-Look" expedition. However, whereas the earlier tests had been limited to well accessible locations, for the Klavervlei sites road construction was a first requirement. It was achieved through the intermediary of the owner of the farm, so that in September 1959 access to Table Mt. was possible. 11 km of roads suitable for four-wheel-drive vehicles were constructed, leading to the three observing locations numbered I, II, and III on Table Mt., marked on the accompanying map.

The Quick-Look expedition was carried out by André Muller in collaboration with the Swedish geodesist C. Ulf. André Muller was one of my associates at the Kapteyn Laboratory and had previously conducted observations at the Leiden Observatory Station on the premises of the Union Observatory at Johannesburg. He was, therefore, well acquainted with South Africa. In November 1959, on the way to South Africa, Muller and Ulf spent a week at the Haute-Provence Observatory in order to gain experience with the use of a Danjon telescope in consultation with the staff of the HPO. They completed the Quick Look per 1 April 1960 after three months of seeing tests and climate monitoring, and Muller reported at the July 1960 meeting of the EC [16].

Letters of Muller to myself in the period December 1959 to March 1960 [17] describe delays in the transport of the telescopes and the rather primitive living conditions under which the Quick Look had to be executed (for shelter during the night a tent was borrowed from the Dutch organization ZWO), and troubles with the instruments, among which a lack of stability of the mounting of the Danjon telescopes under the sometimes very strong (and cold!) winds on Table Mt. For the follow-up of the Quick Look, therefore, new mountings were made at the Kapteyn Laboratory. The first impression of the site on Klavervlei Farm was sufficiently encouraging to make the EC decide on a more thorough comparison with the Zeekoegat area. Besides Table Mt., some other sites on Klavervlei Farm with somewhat different local characteristics were to be investigated: Rockdale Mt. and Flathill mentioned before. Of the three sites on Table Mt. only the most southern one was to be kept. For the new programme, the Danjon telescopes were returned to Paris for thorough overhaul. By the beginning of 1961 they were available again on the sites.

Meanwhile, in the course of 1960, plans for Fehrenbach's GPO project had

II. SEARCHING FOR A SITE IN SOUTH AFRICA



**The Zeekoegat Site.**

**Above:** In spring 1959: members of the "Technical Group" with the owner of Sunny Side Farm; from left to right, Fehrenbach, Haffner, Miss Oosthuizen, Hooghoudt. Photograph by the author.

**Below:** ESO's "Zeekoegat Station" in 1962, in the background ESO buildings and houses. Photograph by D. Beintema.



***The Klavervlei Site.***

***Above:*** Table Mountain (middle, background) and in front of it the Klavervlei Farm Settlement. Photograph by the author, 1959.

***Below:*** Klavervlei Farm Settlement seen from the air; the large dark-roofed house in the lower left housed the ESO observers. Photograph by D. Beintema, 1962.

## II. SEARCHING FOR A SITE IN SOUTH AFRICA

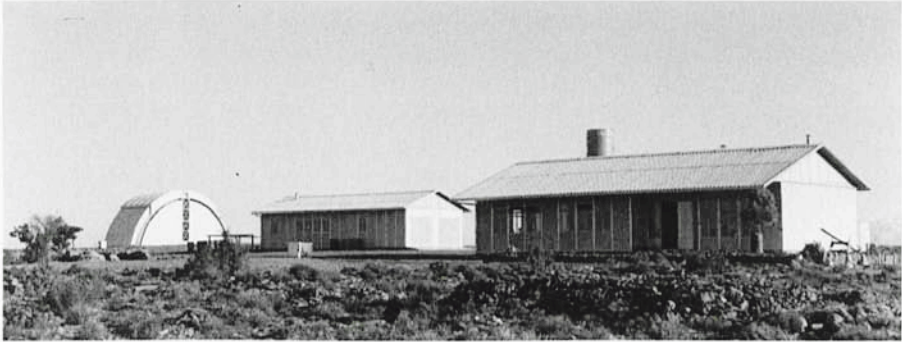

*At the Zeekoegat Station, January 1962.*

**Above:** André Muller with Bert Bosker, adjusting the mounting of a Danjon telescope, in front of the rondavel that housed the instrumentation.

**Below:** at left, the "Abri" housing the Marseilles GPO; middle and right, houses of the observers. Photographs by the author.

advanced so far that a search for a suitable location became desirable. As we shall see in chapter IV, it also was at about this time that the EC agreed in principle to incorporate the GPO into the "initial programme" of telescopes mentioned in the Convention. For the preparation of the many logistic measures connected with it as well as with the Klavervlei testing (erection of GPO housing, satisfactory living quarters for the observers, water and power supply, etc.), Fehrenbach, Couder and Blaauw visited South Africa from mid-November to mid-December 1960. They reported on their visit at the





At Rockdale Station on Klavervlei Farm, January 1962.

**Above:** B. van Geelen of ZWO, at left, talking to observers of the Tübingen photometric project J. Pfleiderer, U. Haug and Kopp in Rockdale farmhouse.

**Below:** Rockdale farmhouse on Klavervlei Farm. Photographs by the author.

January 1961 meeting of the EC [18]. As one of the results of the mission, the choice for the location of the GPO fell on the site near Zeekoegat.

### **The Comprehensive Programme, 1961–1963**

The final, comprehensive programme was planned to run for at least a full year but would, in fact, be concluded only in the course of 1963. It was supervised by a succession of astronomers, the first one being again André

Muller. The simultaneous monitoring of the four sites required a larger staff than had been engaged before, but we realized that it would by no means be necessary for all of these to be astronomers. What we rather needed was: willingness to spend long periods at isolated spots in the desert in primitive housing; handiness in technical matters; a gift of improvisation and elementary cooking; and, last but not least, readiness to perform over extended periods the routine work of the testing . . .

How to find such people? It occurred to me that all this sounded like the interests of an ambitious boy-scout, so we advertized our wishes in a Dutch journal of boy-scout leaders. The result was rewarding: among the applicants were Albert Bosker and Jan Doornenbal, both of whom later became employees of ESO. Among the team that started the work in March 1961 we also encounter the two young German astronomers D. Messerschmidt and W. Schlosser, and G. Bilius, a geodesist from Sweden who took over the local supervision in May 1961. He was succeeded in this capacity by H. Lindén from Sweden over the period from August 1961 to April 1962, by M. Grewing from the GFR from April to October 1962 and next by L. Petterson from Sweden, after which André Muller took over again. Others who over certain periods collaborated in the site tests were P. McSharry, a geodesist from South Africa, and the young astronomers K. Kopp, W. Seufert and W. Weber from the GFR, and D. Beintema from the Netherlands.

A working scheme for the operations had been drawn up by Muller in December 1960 [19]. From it we quote:

*“--- Irrespective of weather conditions, the observers and their assistants are on duty from sunset till sunrise to do meteorological and astronomical observations at regular times.*

*--- Observers and assistants have to work during 25 consecutive nights and after this period have to take leave of 5 consecutive nights. These 5 nights, covering a period of nearly 6 days, can be spent anywhere in the Union of South Africa and special provisions are made to meet extra expenses. With the exception of these 5 nights, there will be no opportunity for outings, whatsoever.*

*The groups of observers and assistants will be shifted from one station to the other at regular times, to ensure a good comparison between the different stations.*

*--- The observers and assistants do organize their own housekeeping [which] includes foraging in Beaufort West, Zeekoegat or Prince Albert ---.”*

An interim report on the new tests was submitted by Muller and Blaauw to the March 1962 meeting of the EC [20]. They had just returned from a visit to the activities in South Africa in December and January made jointly with B. van Geelen who, as an associate of J. H. Bannier of the Dutch organization ZWO, took care of the many financial, administrative and personnel matters

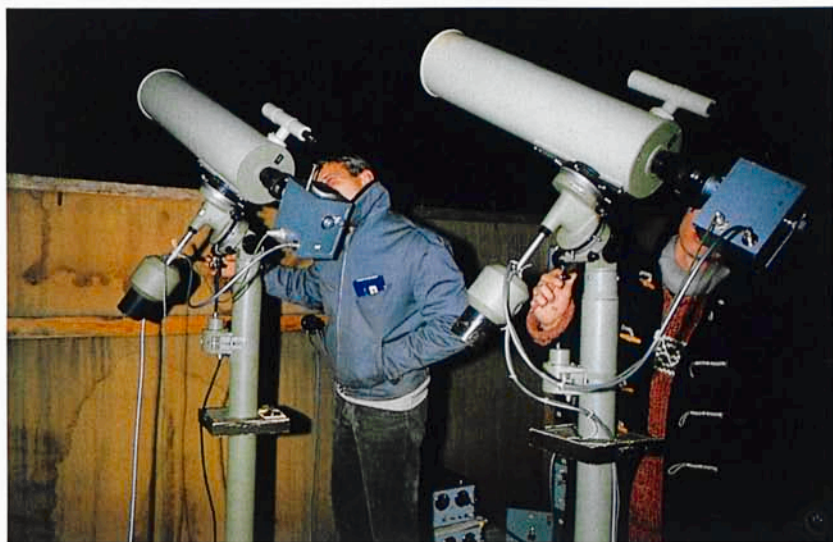

*Site testing in the “Comprehensive Program” in 1962. Top: with the Danjon telescope for image quality. Bottom: with photometric telescopes for extinction measures; here: intercomparison check of two telescopes. Photographs by D. Beintema, 1962.*

connected with the site testing. Their report [21] describes in detail the structure of the site tests at that epoch. The routine monitoring of image quality and climatic conditions proceeded satisfactorily at the four sites. Of the three on Klavervlei Farm, Flathill seemed to emerge as the most favourable one; of the other two, about equal in quality, it was decided to lower the priority for Rockdale Mt. The meeting decided that regular observations should continue till about March 1963, so that the period on which final judgement was to be based should contain two complete runs of the normally most favourable season from November through March.

Muller reported again at the June and October 1962 meetings of the EC, after returning from visits to South Africa. By October the image quality tests on Rockdale Mt. had been stopped (as was the photometric project of Tübingen on that site, described below). With the termination of all tests in sight, the EC appointed a small group to study the results in preparation for the decision on the site, to be chaired by Siedentopf and further consisting of Dommanget, Fehrenbach, Muller and E. Holmberg from Sweden, thus having representatives of the five participating countries.

By the time of this EC meeting of October 19 and 20, 1962 the ESO Convention had just been signed (October 5) and the EC took two important measures. One was the appointment of Otto Heckmann as acting Director of ESO, per 1 November 1962 (to be confirmed after the ratification). Heckmann had visited the ESO activities in South Africa together with Fehrenbach in August and September, 1962. Furthermore, by this time the interest of ESO in the site tests in South America had led to a mission of Muller and McSharry to Chile, to join the American group under J. Stock; McSharry was already on his way at the time of the October 1962 meeting and Muller was to follow him shortly thereafter. Their findings will be reported in the next chapter.

The routine observations of image quality and of climatic conditions terminated, as had been planned, around March 1963. At its February 1963 meeting the EC decided to continue the work in South Africa only for the purpose of an intercomparison of the Danjon telescope tests with telemeter observations as they had been used by Stock's group in the Andes; for this purpose one of their telemeters was shipped to South Africa. This final programme was carried out by McSharry under supervision of Muller.

### **Last Tests in South Africa: the Siedentopf Experiment**

Towards the end of the activities in South Africa, a new kind of test was introduced that had been developed over the past years by Siedentopf and Mayer at Tübingen. It used measurements of the rapid temperature fluctuations which accompany the turbulence in the atmosphere and which, in turn, are correlated to the image quality; see also the description in the accom-

panying box. For the measurement of these temperature fluctuations, thermocouples and resistance thermometers of small time constant were used. By mounting the instruments on masts at different heights, the dependence of temperature fluctuation on elevation above ground level could be measured and, hence, the dependence of turbulence on height. These experiments have played an important role in the decisions taken later with respect to the level at which the telescopes on La Silla were to be mounted.

Applications of the method in ESO context were made by F. Unz in the period July 17 to September 1, 1963 at Zeekoegat and Flathill. After verbal provisional accounts by Siedentopf this work was reported in an ESO publication in 1964 by (the late) Siedentopf and Unz [22]. Simultaneously with these measurements, wind velocity was monitored, and the quality of the seeing was estimated by the measures of image motion with the double-beam telemeters. Two important results were found: the amplitude of the temperature fluctuations decreased rapidly with increasing height within the range of 3.5 to 24 meters, and the difference between the amplitudes at low and high levels was strongly correlated with the amplitude of the image motion. These results immediately led to the conclusion that mounting the telescopes at high level above the ground should eliminate most of the image motion, and hence improve the seeing. A more extensive report was published by Unz in 1970 [23].

### **The Tübingen Photometric Project**

The Tübingen photometric project on Rockdale Mt. ran from August 1961 to November 1962. It was carried out with a 3-colour photometer on a 40-cm telescope by members of the staff of Siedentopf: J. Pfeleiderer, Miss U. Mayer, J. Pesch, U. Haug, and J. Dachs. Also, surface photometry was done of the Milky Way and of the Zodiacal Light in blue and red. Siedentopf reported at the October 1962 meeting of the EC on provisional results. The Rockdale Mt. observations would become part of the data later used by the Site-Selection Committee. Full reports on the Tübingen project were published in 1966 by Dachs, Haug and Pfeleiderer [24] and by Pfeleiderer, Dachs and Haug [25].

### **The Marseilles GPO Project**

Fehrenbach's objective-prism radial velocity project at Zeekoegat became fully operational about the middle of 1961, after delays in the construction phase. It extended in time considerably beyond the termination of the monitoring of image-quality and climatic conditions, until well in the year 1966, after which the GPO was moved to La Silla.

## II. SEARCHING FOR A SITE IN SOUTH AFRICA



***The Tübingen Project.** Observers from Tübingen worked on Rockdale Mt. on stellar photometry as well as on the integrated light from the Milky Way. Shown here are the Tübingen 40-cm telescope with photometer in its housing with the roof removed for observing, and in the background at left the wall around the integrated-light photometer.*



*From left to right: B. van Geelen, H. Lindén and André Muller at one of the telescopes for measuring the photometric extinction.*

*Photographs by the author, in EHPA.*

In the first issue of the *ESO Bulletin*, of November 1966 (the *Bulletins* were a series of ESO publications terminated in 1975), Fehrenbach describes the history of the GPO work at Zeekoegat. Over the years, altogether some thirteen collaborators of which several with their families, most of them from the Marseilles staff, had worked on the project. It produced a large number of GPO plates, most of them on the Magellanic Clouds. However, the observational conditions, although not unsatisfactory, proved to be inferior to those encountered soon afterward on La Silla.

## II. SEARCHING FOR A SITE IN SOUTH AFRICA



*One of the Danjon telescopes, provided in the last stage of the tests with a mask for experiments by A. B. Muller simulating a double beam telescope for measuring image motion. Photograph by D. Beintema, 1962.*

One of the disturbing factors were the strong daily temperature variations at the Zeekoegat site. Moreover, the GPO had been mounted at Zeekoegat at ground level, and one of the measures taken to obtain better image quality at La Silla was placing the telescope at high level. For an early progress report on the project, see, for instance, the *Information Bulletin of the Southern Hemisphere*, No. 2, Sept. 1962, p. 22.

### **The Comprehensive Reports on the South African Tests**

We finally arrive at the reports which sum up the total of the ESO efforts in South Africa. A final report was published as an ESO publication in 1967, long after the decision on the choice of the site had been taken. It was compiled at the request of the Director of ESO by Ursula Mayer of Tübingen who had participated in some of the activities in South Africa, and under the auspices of ESO's Site Evaluation Committee. It carries the title *Astronomical Site Testing in South Africa* and contains contributions by many of the people who had participated or had been actively involved in the tests.

The report systematically surveys studies of the meteorological conditions, matters of organization, and the seeing tests and their results in chronological order. Although the report, in this form, has not played a role in the decision on the site, it remains an interesting document, not just for historical reasons,





MAIN LIBRARY <sup>A-BL</sup>

European Southern Observatory Publication



Astronomical Site Testing in South Africa

edited by the  
Committee for Site Testing  
under supervision  
of  
Dr. U. Mayer

Tübingen 1967

*Front cover of one of ESO's first publications: the comprehensive report on the site tests in South Africa, edited by Ursula Mayer, one of the participants.*

## II. SEARCHING FOR A SITE IN SOUTH AFRICA



*From boy-scout leaders to ESO site testers to ESO employees: Jan Doornenbal, left, and Bert Bosker. Photograph by D. Beintema, 1962.*

but also because in its concise, yet sufficiently detailed presentation it may serve for other purposes of meteorological and astronomical nature. The booklet is in the ESO Library (and probably in many institute libraries) and also forms part of the ESO Historical Archives [26].

The decisive comparison between conditions in Chile and South Africa was based on provisional reports, but on virtually the same data as those used for the final document just mentioned. This comparison was prepared by Siedentopf for the EC Meeting of 15 November 1963; it was published in 1966, in the first issue of the *ESO Bulletin*. Siedentopf used the data collected at Zeekoegat, Flathill and Rockdale Mt., and those collected in Chile by Stock and by Muller and McSharry. We shall return to it in the next article and mention here only that the report confirmed what had been strongly suspected: that the sites in the Andes Mountains around La Serena were to be preferred on several grounds: the number of clear nights, the image quality, and the surprisingly low temperature drop during the night. It was at this meeting, 15 November 1963, that the EC decided in favour of South America.

In the beginning of this chapter I referred to the deterioration of seeing in the course of the night in the northern part of South Africa, mentioned by Bok. Such systematic change is not explicitly discussed in the reports on the ESO tests. However, while preparing this article, I am informed by André

Muller that also on the Klavervlei and Zeekoegat sites this phenomenon was definitely noted and the deterioration was closely related to the decrease of temperature in the course of the night. In fact, according to Muller, this relation provides a strong first indication of the quality of a potential site: the smaller the drop in temperature, the better the site.

Finally, we note that in the course of the tests, the rating of image quality by means of the diffraction rings only was felt more and more as an unfortunate limitation. Nights with “good” rings but appreciable image motion did occur and were of little use for practical work like stellar spectroscopy, as was in fact experienced by observers at the GPO. This was pointed out, for instance, in the report of February 1962 referred to under footnote [21] but it did not lead to drastic modifications of the techniques of observation.

### **At the End, Bewilderment and Consent**

The rather sudden switch from South Africa to Chile did not pass without bewilderment to the young astronomers and their collaborators still at work in South Africa. Had years of effort been wasted? Some disappointment was undeniable. Heckmann was aware of this and expressed it in a letter to me which, unfortunately, I have not been able to recover but of which I do remember the first words: “Mich drückt das Bewußtsein . . .”. Disappointment would soon make room for the conviction that the decision had been right.

### **For South Africa, A Word of Gratitude**

Throughout the work in South Africa ESO profited highly from the collaboration offered by individuals and institutes in this country. There was, first of all, the generous hospitality extended to the ESO teams by the South African observatories, of which we wish to recall in particular that by the Director of the Cape Observatory, Dr. Richard Stoy and Mrs. Stoy, and his associate Dr. David Evans and Mrs. Evans. With the testing activities gradually shifting to the Karroo, we depended more and more on their counsel and support. For the young astronomers arriving from Europe on this new continent, they provided a warmly remembered temporary home base.

## II. SEARCHING FOR A SITE IN SOUTH AFRICA

Strong support was also received from the part of the President of the Council for Scientific and Industrial Research, Dr. S.M. Naudé. CSIR provided know-how on technical matters and made vehicles available for ESO's rather demanding use. Responsible for these services was from 1956 the Director for International Scientific Relations, Dr. C.G. Hide. Essential was also, of course, the strong collaboration and support experienced throughout the work from the part of the owner of Klavervlei Farm near Beaufort West, the Köster family, and of Mrs. Oosthuizen of Sunnyside Farm at Zeekoegat.

### III. 26 MAY 1964: ESO CHOOSES LA SILLA

*“Fehrenbach und ich  
haben den Eindruck, daß der Berg ein großer Glücksfall ist.”*  
From a letter of O. Heckmann to J. H. Oort of April 21, 1964.

In the course of the year 1962, towards the end of the site testing in South Africa, ESO became actively interested in the possibilities offered by the Andes Mountains in South America. After several years of exploration from American side, the Andes had been opened up for astronomy.

#### **Jürgen Stock's Early Explorations**

Among the first who explored the Andes was G. P. Kuiper of the University of Chicago, who examined in March 1959 the area from Antofagasta southward, mostly from the air with the help of the U. S. Air Force [1]. But fully involved in the tests over the years was Jürgen Stock. Stock received his degree in astronomy with Heckmann at Hamburg, and had subsequently been associated with the Boyden Observatory in South Africa. Through his education as an astronomer, his knowledge of the Spanish language, and a sense for pioneering in the almost inaccessible Andes Mountains, Stock became the explorer par excellence for AURA's project. His remarkable reports on the early AURA activities should be read by everyone who wishes to get an idea of what it meant, to conquer the Andes for astronomy [2].

Stock organized in April 1959, as a member of the staff of the University of Texas, a site survey initiated by the Universities of Chile, Chicago and Texas [3]. This was initially meant only for finding a good site for a 150 cm telescope in the vicinity of Santiago, but the survey grew in importance when it appeared that outstanding conditions might be found farther northward. As a result of Kuiper's move to the University of Arizona in 1960, AURA, supported by NSF, took over the management of the "Chile Project" from the University of Chicago [4]. On November 23, 1962 the AURA Site Survey Team chose Cerro Tololo as the site for the Observatory, a decision ratified by the AURA Executive Committee on December 1, 1962.

For the measurement of image quality Stock used a criterion different from that applied by ESO. Instead of going by the appearance of the diffraction image as observed with the Danjon telescopes, image motion was used: the rapid, erratic displacement of the stellar image. In the earlier deliberations of

ESO this method had been contemplated – Couder suggested it early in 1954 [5] – but not chosen because it required much higher stability of the telescope mounting. Stock used a double beam telescope which measured the relative motion of images in the superimposed fields of two telescopes fixed on one mounting, of 10 cm aperture and 165 cm beam separation [6].

### **ESO's Growing Interest in the Andes**

News on the promising results of the American tests reached European astronomers, first bit by bit, then more impressively. The minutes of the May 1959 meeting of the ESO Committee, referring to the work in the Santiago area still read: “*This project will have little influence on the development of ESO.*” But soon after, interest grew rapidly, and the June 1961 meeting decided to send an experienced ESO observer to Chile with one of the Danjon telescopes used in South Africa.

Naturally, the possibility of finding a site better than those considered so far in South Africa, was exciting news. But there was also something else: a certain apprehension about South Africa's future due to the growing unrest in this country. Thus, a letter of April 1960 by Danjon to Oort contains this paragraph: “*Il règne certain inquiétude en France au sujet de l'Afrique du Sud, mais je m'efforce de la conjurer en expliquant que le projet ESO n'est pas nécessairement lié à l'Afrique – – –*”, and in his reply of May 10, 1960, Oort writes “*En vue des difficultés que vous signalez pour la France,*

#### **Maps p. 45–47.**

*Maps showing mountains that have played a role in ESO's search for a site. In the earliest stage, for the purpose of comparing measures with ESO's Danjon telescope with those of AURA's double beam telescope, observations were done on La Peineta and Tololo. In a later stage, Morado on the AURA territory appeared to be a likely site for ESO. In the last stage, the choice was narrowed down to Cinchado on the AURA territory, Guatulame near the town Monte Patria, and La Silla. Also marked are CARSO's site Las Campanas, and Paranal in the most northern area which is the subject of current tests.*

*Useful in preparing these maps have been J.M. Ramberg's article in Sterne und Weltraum of August–September 1964 (in EHA-I.A.2.2.), written right after the explorations of Heckmann et al. in March and April of that year in which La Silla appeared for the first time, as well as a map of the AURA territory in EHA-I.A.2.7., and also the maps in the ESO Annual Report for 1964 and in H.O. Voigt's article on the road construction in ESO Bulletin No. 3 of February 1968. For the maps of Chile, I used the Atlas de la República De Chile issued by the Instituto Geográfico Militar, 1970 edition, property of the author.*









difficultés qui existeront aussi dans d'autres pays, et en vue du fait que les Américains ont récemment obtenu des indications favorables pour les emplacements dans le Chili, il faudra envisager sérieusement la possibilité d'un changement radical vis-à-vis de l'endroit de notre observatoire." Yet, a letter by Danjon to Oort of the 31st of that same month ends with: "Je me contente de vous informer que la situation politique en Afrique du Sud n'est

*pas considérée ici comme une objection.*" [7]. A discussion of the political aspects of the ESO enterprise at the EC meeting of July 1960 confirmed this view. Political concern, although undeniable over the years of ESO's activities in South Africa, never became the dominant element in the considerations with regard to the choice of the site; the decision eventually made was a clear-cut one, based on the superiority of the South American findings.

About the time of the above correspondence, on April 28, 1960, Oort, as Chairman of the EC, wrote to his friend C.D. Shane, Director of Lick Observatory (and serving at that time as acting Director of Kitt Peak Observatory), asking for information on the South American results. From Shane's reply, of May 6, 1960, I quote the following:

*"-- -- There is every indication that the climatic conditions in the neighbourhood of Vicuña are superior to those farther south. -- -- I believe if the ESO Committee is interested we could co-operate in the matter of the site survey to the advantage of both groups. Also, if a suitable mountain top should be found satisfactory to all concerned and if the top area were large enough, perhaps all three observatories [Shane refers here to AURA, ESO and CARSO] could be located there with, of course, a division of the area into distinct parts for administrative purposes. If this could not be done, the next best thing would be to locate the ESO and the American observatories on mountains not too far separated so that there could be easy communications and joint meetings for the interchange of ideas. I hope you will call me for any assistance I can render to the ESO project."* [8].

The November 1961 meeting of the ESO Committee pursued the idea of participating in the American site testing and also expressed the wish for one or more of the Committee members to visit Chile.

### **Muller and McSharry Join Stock's Group**

After preparatory correspondence in June and July 1962 between Blaauw as Secretary of the ESO Committee and Stock [9], two members of the ESO site testing team joined Stock's group: the team's supervisor, A. B. Muller, and P. McSharry, both experienced observers. They arrived in Chile late November. A stay of about two months was foreseen for the purpose of establishing the correlation between observations made with the Danjon telescope and those done by AURA. It did not aim at testing other mountains than those covered by Stock.

Muller and McSharry, with the support of Stock's group, worked on two mountains: first, from December 6 to 19 on La Peineta, just over 3000 m high in the neighbourhood of Copiapo and about 300 km north of La Serena; next, on Cerro Tololo, the AURA site, from December 30 to January 13, 1963. The mountains are marked on the maps on pages 45 and 46. For both,

meteorological observations had been made over a longer period by Stock's group, so that it was possible to arrive at some general conclusions, among which:

- Temperature fluctuations during the night were extremely small, much smaller than on the South African sites;
- Image quality was better than in South Africa: very good and constant on La Peineta and good on Tololo;
- Long spells of clear weather appeared to be a common feature of the climate in the Andes whereas they were rare in South Africa;
- Photometric quality was very good on both mountains.

Muller submitted a report on the two-month work at the February 1963 meeting of the ESO Committee [10]. Impressed by the report, it discussed in some detail the implications: living conditions, construction costs, price levels, etc. in Chile, and the possible relation to AURA. The EC decided to send a small group from among its members to Chile for further investigation.

At this point, the reader should remember that meanwhile, effective the 1st of November 1962, Otto Heckmann had become ESO's provisional Director. We shall return to this appointment in the next chapter dealing with the general administrative set-up of ESO after the Convention had been signed. In the present context it is important to note that from early 1963 Heckmann more and more took ESO's developments in hand.

### **The June 1963 AURA-ESO Summit Meeting in Chile**

The mission to Chile planned in the February 1963 meeting of the EC took place in June 1963. Participants were: J.H. Oort (Chairman of the ESO Committee), O. Heckmann (ESO's Director), Ch. Fehrenbach (Chairman of the Instrumentation Committee), H. Siedentopf (Chairman of the Site Selection Committee) and A.B. Muller (Superintendent of the ESO activities in Chile). Also came to Chile F.K. Edmondson (President of AURA), N.U. Mayall (Director of Kitt Peak Observatory), and J. Stock, who by that time had become Director of Cerro Tololo Inter-American Observatory. On June 6 the two groups met in Santiago and visited the Chilean Observatory on Cerro Calan near the city, and next proceeded to the La Serena area. Heckmann had arrived in Chile earlier than the other ESO officials for contacts with government departments, the universities, ambassadors, building firms, etc.

On June 8, they undertook the trip on horseback to Tololo, where most of June 9 was spent for inspection of the AURA site. From there, both groups went on June 10 to the neighbouring mountain Morado on the AURA territory, south of Tololo; it was AURA's suggestion that this mountain, with its large surface and well tested, favourable observing conditions, might offer

a suitable location for the ESO Observatory. This time, most of the trip was done per helicopter of the Chilean Air Force so that on Morado ample time was left for a summit meeting – in the double sense of the word. Principal subject of the discussion was the possible relation between the AURA and ESO projects in case ESO should decide to settle here, and a first draft for a possible agreement was prepared. Items further to be worked out were: arrangements to be made for road construction and maintenance, water supply, taking care of mining rights possibly to be claimed by third parties, co-ordination of personnel matters, etc. The remainder of Heckmann's stay in Chile served for extending his relations with Chilean authorities.

A fairly detailed report on the Chile mission, compiled by the ESO Directorate was sent to the members of the ESO Committee [11]. Attached to this report are copies of letters expressing the interest of the Chilean Ministry of Foreign Affairs, the report of the visit of Heckmann and Oort to the President of the Senate of Chile, and a summary of the comparison of the climatic conditions in South Africa and Chile as discussed at the Summit Meeting on Morado on June 10. Also attached is the text of the Draft Agreement between ESO and AURA drawn up on June 6 and 9, 1963, and an excerpt of the Chilean Law in favour of international enterprises.

### **Follow-up on the Summit Meeting**

A meeting of the EC followed right after the return of the mission in Europe, on July 23 and 24, 1963. It instructed the Director of ESO to approach the Chilean government concerning the conditions which would have to be fulfilled in order to make it possible for ESO to go to Chile, and negotiations with AURA should be pursued.

#### **June 10, 1963: Summit Meeting on Cerro Morado.**

*On June 8–10, 1963, ESO officials were the guests of AURA on their property and on June 10 gathered on Morado, discussing ESO prospects in Chile.*

*Top photograph: from left to right: N. U. Mayall, H. Siedentopf, Ch. Fehrenbach (in foreground), J.H. Oort (only partly visible), Sr Marchetti (architect, behind J.H. O.), O. Heckmann, A.B. Muller, F.K. Edmondson.*

*Bottom photograph: from left to right: A.B. Muller, O. Heckmann, J.H. Oort, H. Siedentopf, Ch. Fehrenbach, Sr Marchetti.*





*En route – the same group as before. On horse-back, from left to right: Ch. Fehrenbach, O. Heckmann, Sr. Marchetti, J. H. Oort, N. U. Mayall, F. K. Edmondson and A. B. Muller.*

*All three photographs were kindly made available by Dr. F. K. Emondson.*

On AURA side, its President F. K. Edmondson had informed the Director of the National Science Foundation (NSF), the sponsoring organization for AURA, on the developing relation with ESO. He received approval of a resolution adopted by the Executive Committee of AURA on June 28 stating that AURA, having dedicated itself to the development of astronomy in the Southern Hemisphere, including observations made by South American astronomers and those from other countries, welcomed *“the interest of the European Southern Observatory (ESO) in establishing an observatory in Chile, and in particular on the land which AURA had recently acquired. – – –”*, and authorized AURA’s President to enter into negotiations with ESO. Edmondson communicated this to Oort in a letter of August

20, 1963, which was acknowledged by Oort per letter of August 23 [12]. Immediately following these letters, Heckmann in correspondence with Edmondson sketched a number of first measures to be taken in order that already in 1964 ESO's 1-m Photometric Telescope might be erected on Morado [13].

The talks with AURA were continued on October 11 and 12, 1963, when Heckmann visited Tucson. As in the account of this meeting we perceive divergences of concepts which would eventually lead to separate establishments, I shall report on it in some detail. Participants in the discussions on the part of AURA were its President, F. K. Edmondson; R. Wildt, Chairman of the AURA Scientific Committee; N. U. Mayall, Director of Kitt Peak Observatory; and J. Stock [14].

All present considered close relationship between AURA and ESO mutually advantageous. Central theme was ESO's strong interest in Morado, and immediately connected with this was the question whether ESO might lease or purchase the land. Heckmann rather persistently expressed ESO's strong preference for purchase, a desire that, within ESO, stemmed particularly from the side of the governments. This desire, however, met with considerable reluctance on the part of AURA, a reluctance inspired by the policy of NSF.

In addition to this, there was an element that appeared to be new to AURA: for the agreement to be concluded with Chile, ESO had in mind a contract at government level, in a way an extension of the Convention between the European governments, hence one with the Chilean Ministry of Foreign Affairs. Models were the agreement between CERN and Switzerland and the one between UNESCO and Chile. Exploratory steps toward such an agreement had been taken already during Heckmann's visits to Chilean authorities. For AURA, being an association of universities, the natural base for its relation with Chile was its contract with the University of Chile. Moreover, an important feature of the agreement of the kind envisaged by ESO would be a certain degree of extraterritoriality and associated diplomatic status for its establishment, like that of other international organizations in Chile. The dissymmetry implied by this status as compared to the one of AURA caused reluctance on the part of the latter: associating themselves with ESO with its extraterritorial status might, AURA feared, tend to endanger AURA's relation to Chileans. This status, moreover, would seem hard to reconcile with establishment on grounds leased from AURA. For Heckmann, however, the intended nature of the contract with Chile was virtually beyond discussion.

Still another element entered the discussions, and this one somewhat unexpectedly to ESO: the recently developed interest from the part of CARSO in possibly acquiring a share in Morado. CARSO (Carnegie Southern Observatory) aimed at erecting in the Southern Hemisphere the counter-

part of the Hale Telescope and had in May 1963 been granted funds for site survey work [15]. Like ESO, it made grateful use of the findings of Stock and associates and it expressed particular interest in Morado. This tended to limit the share ESO might acquire in this site.

The lengthy discussions on October 11 and 12, 1963, left the main problems unsolved. AURA expressed willingness to reserve a temporary site on Tololo to enable ESO to start scientific work at the earliest possible date, and was prepared to recommend to the AURA Executive Committee a long-term (50 years) lease of part of Morado, but it was not prepared to recommend sale; an attitude due at least partly to apprehension with regard to ESO's intended status. In a letter of October 23 to Heckmann, Edmondson confirmed the main points mentioned here and added the offer, to allow provisional installations of ESO on Morado even if ultimately ESO would build its Observatory elsewhere [16]. Informal talks followed on Sunday, October 13, between Heckmann and Wildt who communicated his impressions in a letter to Edmondson of October 16 [17]. Wildt noted that Heckmann, perhaps over-optimistically, might not be fully aware of the amount of further negotiation still required even for reaching the suggested lease. As to the intended status with extraterritoriality, Heckmann promised to submit to AURA the draft-agreement with Chile before it would be signed and he confirmed this in a letter to Edmondson of October 20 [18].

The negotiations between AURA and ESO were resumed early 1964, but at this point I should first describe developments occurring in the intervening months. By the end of October 1963 Heckmann was back in Chile for further negotiations with authorities in Chile, accompanied by Dr. K. Walters, ESO's legal advisor.

During this stay, Heckmann went as far as concluding the basic agreement with the Chilean government: the *Convenio* [19]. It is an agreement between ESO and the Chilean Ministry of Foreign Affairs and therefore one at the highest possible level. In this respect it is comparable to the ESO Convention. The *Convenio* was modelled after the agreement between Chile and the Economic Commission for Latin America, CEPAL (an affiliate of the United Nations) which has its Headquarters in Santiago, and it was adapted to ESO's legal status, immunities and exemptions, etc. as they are also recognized in the European context: the ESO Convention. The Chilean Ministry moved so fast and efficiently, that already during Heckmann's stay, on November 6, 1963, the agreement was signed in principle, to become effective upon endorsement by the ESO Council and by the Chilean parliament. (These endorsements took place from ESO's side at the first Council Meeting, February 5-6, 1964, and from Chilean side on April 17, 1964). However, for the EC these rapid developments came as a surprise, and as we shall see, not without embarrassment, for Heckmann had run a bit ahead of things . . . He was back in Europe on November 9, 1963.



## ESO Chooses the Andes Mountains for its Observatory

At its meeting on November 15, 1963, the EC first of all considered the basic question of the choice between South Africa and Chile. A report prepared by Siedentopf on behalf of the Site Selection Committee was the basis for the discussions; the Committee had convened on August 6, 1963, at Groningen, and on October 15, 1963, at Tübingen [20]. The report has been published in 1966 in the first issue of the ESO Bulletin [21]. In making his comparisons Siedentopf used the data collected at Zeekoegat, Flathill and Rockdale Mt. in South Africa, and those collected for Tololo by Stock and by Muller and McSharry. In the accompanying box we summarize the principal items of Siedentopf's report. Following this presentation and a relatively brief discussion, the ESO Committee decided unanimously to choose the Andes Mountains for the site of the ESO Observatory, subject to confirmation by the later "legal" Council. The superiority of the climatic conditions was so impressive an argument, that very little discussion was devoted to financial implications, and to the interesting and challenging prospect of building up relations with a country that in respect to culture and language so far had been much more remote to most of the ESO countries than South Africa had been.

### Some Data from the Report of the Site Selection Committee,

on the basis of which the Andes Mountains were chosen for the site of the ESO Observatory. (Borrowed from ESO Bulletin No. 1, 1966.)

**Number of Clear Night Hours per Year** (A clear night defined as one with at least six successive cloudless hours.)

<i>South Africa</i>	<i>latitude</i>	<i>hours</i>	<i>Chile</i>	<i>latitude</i>	<i>hours</i>
Capetown	- 34°	1470	Santiago	- 33.5°	1675
Rockdale Mt.	- 32.5°	1285	Tololo	- 30°	2300
Boyden Obs.	- 29°	1750	Copiapo	- 27.5°	2760

N.B. Long spells of clear nights more frequent in Chile than in South Africa.

#### Image Quality

Tololo distinctly better than the South African sites, both with regard to turbulence (measured with Danjon telescope) and image motion (measured with double beam telescope).

#### Average temperature drop during clear night

Zeekoegat 4.2°	Tololo (Muller and McSharry)	1.3°
Flathill 5.8°	Tololo (Stock)	1.8°

#### Average Wind Velocity

At Tololo higher than at Rockdale Mt. and much higher than at Flathill and Zeekoegat.

#### Atmospheric Transparency

For both Rockdale Mt. and Tololo close to expectation for pure Rayleigh scattering; very little dust content.

## The Convenio with Chile

Proceeding next to Heckmann's account on his visit to Chile, the ESO Committee took note with mixed feelings. The Chairman of the provisional Finance Committee, although recommending to the EC approval of the agreement with the Chilean government, reproached Heckmann to have exceeded his authority: the text of the agreement should have been scrutinized and approved by the Provisional Finance Committee and EC prior to signing, and, moreover, the signing should have waited for the completion of the ratifications of the ESO Convention. On the other hand, the EC's Chairman expressed appreciation and admiration for the work done by Heckmann and Walters. The EC then decided to submit the agreement for endorsement at the first Council Meeting following the completion of the ratifications in Europe. (On February 5-6, 1964.)

Heckmann, although showing understanding for the objections from a formal point of view, must have felt wronged by the reactions in the EC. Let me quote a relevant part of the account in his book *Kosmos, Sterne, Weltmodelle*, written a decade later [22]:

*“— — — Mir werden heute noch die heftigsten Bedenken wach, ob damals die Mitsprache bei der Textgestaltung von fünf europäischen Regierungen, mindestens also fünf, wahrscheinlich mehr, Ministerien, überhaupt etwas anderes als einen Zeitverlust von Monaten oder Jahren eingebracht hätte. Die europäischen Mitgliedsstaaten waren der empfangende, Chile war der gebende Teil. — — —”*

Anyone who remembers the discouraging struggle within Europe for the ESO Convention, described in the first chapter, will have understanding for Heckmann's feelings . . .

Heckmann's book throws interesting light on what had made such unexpectedly rapid concluding of the Convenio possible. It was to a considerable extent due to influential persons in his circle of friends and colleagues. In order to appreciate this, one must remember that since long Chile had a strong German component in its population and a stronger tradition of cultural relations with Germany than with other ESO countries. Functionaries of German descent could be encountered at important governmental and cultural posts in Chile, and it was natural for these to sympathetically support the plans submitted by this energetic and highly esteemed scientist from Germany. Two of these should be mentioned here: E. Heilmeier, professor of astronomy at the Universidad Católica in Santiago, and Father Dr. B. Starischka, rector of the German High-School (Liceo Alemán) in Santiago.

It was especially Dr. Starischka who paved the way for Heckmann's approaches to government authorities. His role is not only acknowledged in Heckmann's book, but also appears from an account he recently wrote at the

suggestion of Dr. E. Geyer of the Hoher List Observatory and kindly passed on by the latter to me. Several of the ministers in the government of the then President Jorge Alessandri were alumni of Starischka's School, including those of the Interior and of Cultural Affairs and the Minister of "Tierras y Colonisaciones" whose support would be invaluable for the acquisition of the ESO territory. At all these levels, including that of the President (an engineer by schooling) strong sympathy for the project was rapidly aroused. However, Chile was up for new elections by the end of 1964, and a change in the constitution of the government was expected. Heckmann was urged from many sides, including diplomatic ones, to strike while the iron was hot.

### **The Relation to AURA**

Not only the EC was taken by surprise, so was the AURA Board. Contrary to Heckmann's promise, AURA had had no opportunity to comment on the draft text of the Convenio. Disappointment was expressed by AURA's President, Edmondson, in a letter to Heckmann of November 27, 1963 [23]. This letter crossed one of Heckmann of November 29 in which he offered explanations which – at least to the author of this article – do not sound very convincing [24].

The failure to arrive at an arrangement by which the AURA and ESO Observatories would be erected in close proximity caused disappointment at the EC meeting of November 15, 1963, particularly with its Chairman, Oort. On November 17, Oort expressed deep concern about the developments in letters to Edmondson and Mayall [23]. On November 21, the eve of the AURA Executive Committee meeting of November 22 in Tucson, he made a long telephone call to Mayall, with Edmondson and Wildt listening in [24], and followed up with letters to Mayall of November 21 and 22. However, these letters opened no fresh points of view. Meanwhile, this AURA Board meeting had adopted a resolution to the effect that, in view of established AURA policy with regard to Kitt Peak, now to be extended to their Inter-American Observatory in Chile, sale of AURA property should be virtually impossible. Although the resolution did not mention ESO, its implication was clear. In his letter to Oort, Chairman of the EC, of November 26, 1963, in which Edmondson communicates the text of the resolution, he adds "*I hope this resolution will clarify our position to the ESO Council.*" [25].

Although some temporary stiffening of the relation between AURA and ESO cannot be denied, nor a shadow on the high expectations of intimate collaboration, a desire remained on the part of both to continue the negotiations. Mayall's letter of November 27 in reply to Oort's letters mentioned before concludes with the statement "*With the obvious goodwill that exists between all parties, I see no reason why we cannot come to an agreement*

*acceptable to all interested parties. For my part, I try to keep foremost in mind the very desirable objective of a close community of astronomers, who would benefit very much by scientific discussions with their neighbouring colleagues. I think this situation is especially important to have in a remote area like that in Northern Chile.*" [26]. It is also worth mentioning at this point, that throughout the whole period of contacts between Heckmann and Edmondson, dating from well before Heckmann's activities for ESO till the time of his death in 1983, a relationship of close personal friendship existed between the two, not perturbed by the wrinkle in the formal relation between the two organizations [27].

Negotiations between ESO and AURA were continued on the occasion of a visit of representatives of AURA and CARSO to Europe. They met ESO representatives on January 21, 1964 in Paris. The meeting had been preceded by informal consultation between Heckmann and Mayall in December [28]. It arrived at a draft cooperation agreement between AURA and ESO "— — — *desirous to arrive at an efficient coordination in the exploitation of their Observatories in Chile* — — —" and it agreed — pending approval by AURA Board and ESO Council — on a number of recommendations which essentially implied that AURA would be willing to sell to ESO property on their area south of Morado, possibly extending to the southern border of the AURA domain, including Cinchado but excluding in first instance Pachón (in which CARSO was interested). It also stated that, might Morado or Pachón prove superior to any of the other sites, ESO be allowed to erect its largest instrument on Morado or Pachón on a restricted area [29]. The AURA Executive Committee approved the agreement on January 31 [30], and so did the ESO Council in its first "legal" meeting on February 5 and 6, 1964. Thus, the road remained open for further shaping close collaboration between AURA and ESO and there was a concensus of opinion among the ESO Council that the draft agreement with AURA balanced in a satisfactory manner co-operation and independence.

Meanwhile, however, there had been for some time already an undercurrent in the internal ESO deliberations favouring a still more independent position. This was advocated particularly from the side of the government representatives; such greater independence might be preferred even at the cost of more delay in the operations and higher investment expenses [31].

### **ESO Chooses La Silla**

In preparation for the final decision on the site, the February 1964 Council meeting appointed a working group consisting of Fehrenbach, Rösch (also from France, Rösch had succeeded Siedentopf as Chairman of the committee for the evaluation of the site tests) and Muller, together with Heckmann. Its

assignment was, to have a new look at Cinchado and other sites within the AURA domain as well as in the general vicinity. By letter of February 20, 1964, Oort informed Edmondson about the decision [32]. Heckmann left on March 18 for Chile where Muller joined him and so did, for part of the time, Fehrenbach and Rösch. He returned to Europe at the end of April. During his stay Heckmann reported to Oort in two long letters, of March 30 and April 21 [33].

These two letters are of considerable interest for proper understanding of the developments soon leading to the choice, not of a site within the AURA domain, but of one that came only rather late in the picture. I summarize here the most relevant points.

In the first of these letters, after briefly reporting on his visits to the AURA area and AURA Headquarters in La Serena with Muller and Rösch, including talks to Stock, Heckmann, reflecting on the earlier discussions with Mayall, states that he may have interpreted these erroneously; that once AURA had acquired its extensive property and resolved to invite others like ESO to "*share its luck*", it must have appeared presumptuous and unnatural to AURA if such parties would approach it about sale of part of this territory, and that AURA's agreeing, in Paris, to such sale was a special concession and by no means a matter of course. However, according to Heckmann, even then a certain restriction on the part of AURA would remain because in several respects, particularly in the context of the construction activities, ESO would necessarily have to adjust itself to AURA rules. Reflecting next on the philosophy of AURA-ESO collaboration, Heckmann wonders what this would amount to in practice: observers at work during the night would have little time to meet, and at Headquarters only few astronomers would be present at any given moment. Sharing costs in practice probably would not really lead to appreciable reduction . . . On the other hand, it should be in such matters as joint observing programmes, joint colloquia and seminars, possibly at the University of Chile in Santiago – not really requiring physical proximity of the Observatories – that collaboration should take shape.

The second letter reports, among other items, on the selection of three mountains which on the basis of inspection by helicopter and by car and aerial photographs were left for further investigation: Guatulame, South-East of Ovalle; Cinchado on AURA territory; and Cinchado-North. The positions of the three are marked on the maps. The last one of the three turned out to be the most interesting one from the point of view of accessibility, climatology (dry), proximity of a flat area to be used for a landing strip, and the fact that it was government property and hence probably obtainable without complication. Let me quote some parts of this letter of April 21, 1964:

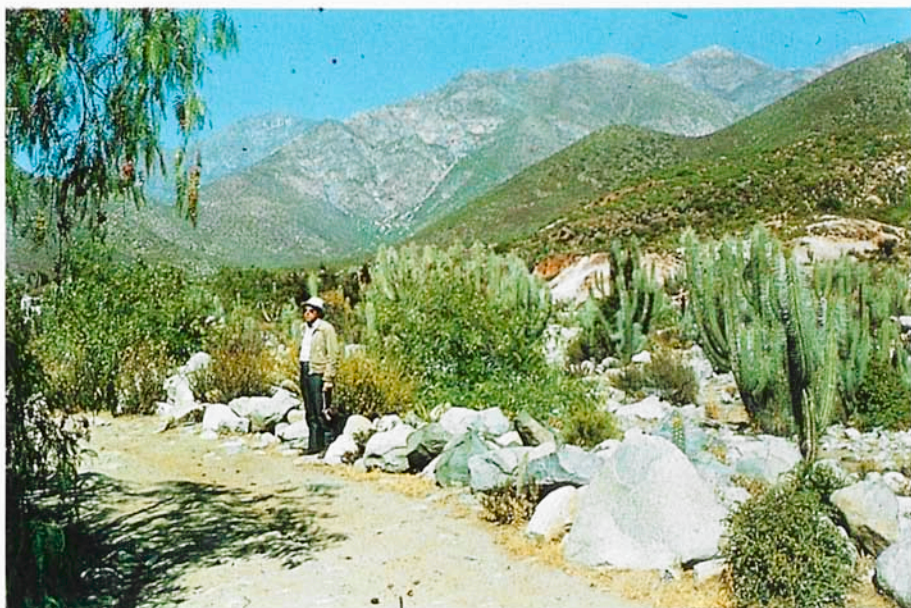



**Looking for a site, March 1964.**

In March 1964 Heckmann and Muller, together with, first, Jean Rösch and later with Charles Fehrenbach, explored a variety of potential sites for the ESO Observatory in the Andes Mountains in the general neighbourhood of La Serena. Among these were the mountains Cinchado within the AURA territory, south-west of Cerro Tololo, El Gigante about 40 km south-east of Tololo, and Guatulame 70 km south of Tololo. On these three photographs we see:

**left, top:** Heckmann, the driver, Mrs. Heckmann and Muller with in the background El Gigante (over 3000 m high); **left, bottom:** Muller with in the background Guatulame; **right:** Rösch and Muller in front of Cinchado.

From photographs made available to the EHPA by J. Rösch.

*“Lieber Jan:*

*Unsere Tätigkeit hier beginnt auszuklingen. Alle werden in dieser Woche wieder nach Europa fliegen. --- Ich glaube, wir können mit unserer Arbeit zufrieden sein, und hoffentlich ist es der Council auch. ---*

*Der interessanteste Berg scheint uns bisher Cinchado-Nord zu sein, ca. 100 km NNO von La Serena, --- erreichbar von der schnellen Panamericana auf ca. 35 km sehr primitiver Straße. --- Ohne Dich zu fragen, haben Fehrenbach und ich uns für berechtigt gehalten, Muller zu ermächtigen, auf dem Berg vorläufige Arbeiten zu beginnen. Wir haben Luftbilder bekommen und werden eine Karte herstellen lassen. Zum Council-Meeting werden wir schon mehr wissen. Fehrenbach und ich haben den Eindruck, daß der Berg ein großer Glücksfall ist. ---”.*

The name we now use for this mountain: La Silla.

Heckmann reported at the Council meeting of May 26 and 27, 1964. Council resolved to choose La Silla provided reasonable solutions could be found for the provision of water and for the question of the mining rights, and if the price would be acceptable; it accordingly authorized Heckmann to enter negotiations. Naturally, also the relation to AURA was discussed. Heckmann reported on a discussion on Tololo with AURA representatives on April 12, and on a later discussion between Fehrenbach and Mayall, in which full understanding for ESO's interest in alternative solutions was expressed. Oort informed Edmondson on the decision of the ESO Council by letter of June 12, 1964, with copy and accompanying letter to Mayall. From the last one I quote: *“--- Personally I am disappointed that this decision will make our relations in Chile less intimate than they would have been if our observatories could have been erected on Morado, as had been provisionally planned during our beautiful common trip, last year. But, considering the circumstances as they have gradually developed, I believe that the course we have now decided on, may be the best. ---”.* Mayall, in his reply of June 20, expressed the same feelings. From Edmondson's reply of July 7, let me quote: *“--- I see no reason why there should not be frequent contact between ESO and AURA astronomers, even though ESO locates outside of the AURA domain. I am sure that such contacts will develop in a very natural way. ---”* [34].

As we know now, the conditions imposed by Council were satisfactorily met by Heckmann's subsequent negotiations, and so the decision of the Council meeting on May 26, 1964, did imply the final choice for ESO's site: La Silla.

With many suitable mountains in the Andes around La Serena, how had the working group arrived at narrowing down the choice to La Silla and Guatulame, besides Cinchado Sur on the AURA property? The basic idea, as described by Heckmann [35] was, to look first of all for government property, as this would facilitate the negotiations for purchasing, especially in





*First photograph of La Silla, taken from the top in North-Westerly direction, by Heckmann on the occasion of his first landing on La Silla in the company of Fehrenbach and Muller in April 1964. In the foreground the helicopter made available by the Chilean Air Force. Behind the helicopter is the knoll which first carried only the water tanks and now also the New Technology Telescope. Behind this, the ridge on which now most of the telescope park is located. Reproduced from two photographs in the ESO Photographic Archives stored in an envelope marked "Helikopterflug April 1964" in Heckmann's handwriting. From these two photographs, covering the left and right hand part of the view, the ESO Information Service produced this uninterrupted panorama.*

view of the recently concluded Convenio. Rösch, according to Heckmann, managed to borrow from the Ministerio de Tierras y Colonización a unique atlas, scale 1 : 200,000 of all government property. From it they selected the two new sites and they obtained further information on water sources and mining activity from maps of the Instituto de Investigaciones Geológicas. Closer inspection of the sites was done by means of a helicopter put at their disposal by the Chilean Air Force.

Reviewing these developments, the reader may be surprised by the absence of a thorough test of La Silla before it was adopted by ESO. André Muller reminds me of the conviction established at that time by Stock's tests: almost any mountain top in the La Serena area at the level 2000 to 3000 metres, well isolated from the surrounding peaks, should be adequate. The almost universal property of the near-absence of temperature drop during the night on these mountain tops virtually guarantees good seeing quality.

A comparison of seeing between La Silla and Morado was carried out in the context of CARSO's Site Survey in 1966/67 by John B. Irwin and reported in ESO Bulletin No. 3. Equality of seeing conditions on the two sites, confirming the above expectation, is implicit in Irwin's Table 1. Explicit is John's praise of ESO's "*meals that are the envy of the Morado observers*".

## **IV. COUNCIL AND DIRECTORATE SET TO WORK; THE INITIAL PROGRAMME OF MIDDLE-SIZE TELESCOPES**

*„Es würde mir als lohnende Aufgabe erscheinen, den Rest  
meines wissenschaftlichen Lebens dem Aufbau des ESO zu widmen.“*  
From a letter of O. Heckmann to J. H. Oort of December 1, 1961.

### **Introduction**

Once the ESO Convention had been signed, in October 1962, and the ratifications were in sight (completed January 1964), many activities developed: by the ESO Council, the now “legal” successor of the ESO Committee, and by the ESO Directorate headed by Heckmann. In the present and the next two chapters I shall describe developments over the six years which followed, leading to the dedication ceremonies on La Silla in the spring of 1969. These ceremonies marked the completion of what we may now call ESO’s first phase.

In these developments we distinguish two main lines. In Europe: building up ESO’s organizational structure including financial, personnel, legal and many other matters as well as the design and construction of telescopes and auxiliary instrumentation of the “Initial Programme” defined in the Convention. In Chile: the extensive programme of infrastructure and constructions; building up the Observatory on La Silla and the facilities in Santiago and La Serena. In the present chapter we deal with activities in Europe, and in the two following chapters turn to those in Chile.

### **Heckmann Becomes ESO’s First Director, November 1962**

The need for executive leadership was felt soon after the ESO Committee had undertaken to realize the ESO project, but particularly so in the late 1950’s, and names of candidates were proposed. The most obvious choice was Charles Fehrenbach, in view of his accomplishments in instrumentation and in building up the Haute-Provence Observatory. However, these and other obligations in French astronomy made it impossible for him to accept. As a second possibility my name was mentioned, but obligations with regard to the directorship of the Kapteyn Laboratory assumed in 1957 made me,

too, refrain; instead I took over the Secretariat of the ESO Committee from Bannier from early 1959 [1]. This was a temporary solution, and the need for a director remained.

The solution was found when in the course of 1961 Otto Heckmann, a member of the ESO Committee, appeared to seriously consider a suggestion, made from various sides, to take the task upon himself. The matter was discussed between him and Fehrenbach during their joint visit to American observatories in the summer of 1961 to which we shall return below [2]. Soon after this, responding to a remark in a letter of Oort, Chairman of the EC, of November 27, 1961, Heckmann wrote on December 1, 1961 [3]:

*„--- Es würde mir als lohnende Aufgabe erscheinen, den Rest meines wissenschaftlichen Lebens dem Aufbau des ESO zu widmen. Da ich aber mit der Universität Hamburg und der Hamburger Sternwarte sehr fest verknüpft bin, so ist die Lösung dieser alten Bindungen schwierig ---“.*

In the meeting of the EC of June 18, 1962, Heckmann accepted, first for one year only, from November 1, 1962, and subsequently on a long-term basis. Heckmann was then 60 years old. He put his shoulders under the ESO task until his retirement per January 1, 1970: determinedly, and with plenty of drive. After the necessary preparations he felt ready for the job in the spring of 1963, so that by circular letter of April 17, 1963, signed by Bannier and Heckmann, executive authority and financial responsibility were transferred per May 1, 1963 from Bannier as Treasurer of the EC to Heckmann as Director [4].

Heckmann's first associate at Directorate level was André Muller who had been heavily involved in the site tests, first in South Africa and next in Chile. As Superintendent for Chile his main responsibility would become the supervision of the extensive construction programmes. Muller's employment as an associate of Heckmann started per January 1, 1963, but since at that time ESO did not yet possess the administrative set-up for formalizing the appointment, he first remained on the payroll of the University of Groningen to whom ESO reimbursed his salary [5]. Muller was the first staff member to become permanently employed by ESO.

Per April 1, 1963, Heckmann appointed the accountant H. W. Marck, and the next appointee – apart from temporary secretarial help – was J. Bloemkolk as Manager per October 1, 1963 [6]. Bloemkolk's assignment was meant to be in Chile, but it was fairly soon changed into one covering the administrative business of the Director's Office. Another important appointment was that of Jöran Ramberg as Assistant Director per November 1, 1963. A staff member of Stockholm Observatory, Ramberg had since November 1961 contributed to the development of ESO as a Secretary of the Instrumentation Committee, the role of which will be described below. He would become Heckmann's right hand in the development of instrumentation and buildings.

After the ratifications, from early 1964, ESO staff underwent rapid growth which we shall not follow in detail; we will have occasion to refer to certain staff members individually in the context of their tasks. This may be the proper occasion, though, to acknowledge the dedicated role of Otto Heckmann's wife, Johanna ("Hanna") Heckmann-Topfmeier who closely accompanied her husband in almost all areas of his comprehensive task, and thereby became intimately acquainted with the ESO project. Whereas at formal occasions she remained in the background, she used to take an appreciable share in the daily administrative chores of the Office; energetic, cheerful – and, as an unpaid employee, not without a bit of embarrassment for Council . . .

### **Council and Finance Committee**

Article V of the ESO Convention defines the constitution and tasks of the Council. It consists of two delegates per Member State of whom at least one should be an astronomer. The Financial Protocol attached to the Convention (and referred to in its Art. V.2.b.) defines the constitution and task of the Finance Committee (henceforth to be denoted by FC). It is, next to Council, the most authoritative administrative body. Contrary to other committees that help ruling the organization and for which the membership is determined by Council (like for instance the Instrumentation Committee) members of the Finance Committee are government representatives (Art. III of Fin. Prot.), one per Member State, and thereby form the direct link to the national financial authorities. No major financial decision is taken by Council without having been submitted first to the FC. Council policy and FC's counsel have always been intimately interwoven.

Annex 5 A gives the dates and places of the meetings and the names of the Presidents of Council and of the FC over the period ending with the year 1969. The first Council Meeting, held in the French Ministry of Foreign Affairs right after the ratifications of the Convention, took place on February 5 and 6, 1964 and elected J. H. Oort as its first President. Oort resigned from this office at the Stockholm meeting of June 1965, to be succeeded by Bertil Lindblad – an election honouring Lindblad's important contribution to the creation of ESO. Unfortunately, on June 25 Lindblad passed away, after which Oort again chaired the Council Meeting on Nov. 30/Dec. 1, 1965. This meeting elected G. W. Funke, the non-astronomical Swedish Council delegate as President. After Funke had completed his three years in office – the maximum term allowed by the Convention – the Council in its meeting of Dec. 3 and 4, 1968 elected as President the non-astronomical delegate from the Netherlands, J. H. Bannier.

The first meeting of the FC took place on February 6, 1964 at Paris,

#### IV. COUNCIL AND DIRECTORATE SET TO WORK



***Second Meeting of the ESO Council, with their advisors on May 26–27, 1964, at Observatoire de Haute-Provence.***

*From left to right:*

*Top photograph: J. H. Bannier, M. Deloz, K. Walters (legal advisor to the Director), J. Ramberg, O. Heckmann, J. H. Oort.*

*Bottom photograph: B. Lindblad, G. Funke, A. Reiz (Observer for Denmark), J. Rösch, A. Blaauw.*

*The Top photograph is part of the ESO Historical Archives contributed by J. H. Bannier, the Bottom one was contributed by the author. Most likely, more photographs of the session were taken . . .*

immediately following the first Council Meeting. Its first President was J. H. Bannier, who was in office until he assumed the Presidency of the Council in December 1968. He was succeeded as FC President by the German government delegate K. F. Scheidemann.

## Earliest Developments in Instrumentation

Of the many tasks facing Council and Directorate in Europe, the development and realization of the observational equipment was the central one. From the outset it had been agreed that in accordance with Baade's proposal, the nucleus of the equipment should be a powerful reflector and a large Schmidt telescope. For the first one, the natural example was the 120-inch reflector of Lick Observatory with its up-to-date design by the Lick staff. It came into regular operation in February 1960 [7]. Aiming at a still larger size such as that of the Mt. Palomar 200-inch (in regular operation since November 1949 [8]) would have been too ambitious for ESO; exceeding the size of the Mt. Wilson 100-inch, the leading instrument of the past decades, was an interesting proposition. The Schmidt would be an essential auxiliary: the Palomar Schmidt, in operation since January 1949 [9] had proven to be indispensable as survey instrument for the work with the large telescopes. For both instruments, the design might be copied and thus time and costs be saved. We shall see, though, that ESO would prefer modified solutions.

As a third instrument, the first meeting of the ESO Committee, in June 1953, proposed a meridian circle, although a strong tradition in positional astronomy did exist in the Southern Hemisphere, established by the Observatories of the Cape and in South America. However, compared to the Northern Hemisphere their number was too small. Moreover, positional astronomy was a strong component of the work of several European observatories and overall coverage of the sky essential for the establishment of the fundamental reference system. As we shall see, not a meridian circle but a modern alternative would be acquired by ESO: a Danjon astrolabe. Other additional middle-size instruments, suggested at early EC meetings, included a copy of the Lick Double Astrograph and a copy of the Marseilles GPO. Only the latter would later be realized, it played a role in the site tests in South Africa (see chapter II). We shall return below to the further specification of the middle-size instruments.

The principal concern of the EC in the early years was, however, a different matter; it realized that for the further planning, both financially and as to time schedule, it had to engage expertise in telescope design, not necessarily by an astronomer. Two names figured in the EC's deliberations already in the middle 1950's: those of B.G. Hooghoudt and of W. Strewinski, both well qualified. The engineer Hooghoudt was responsible for the successful design of the mechanical parts of the Dwingeloo radio telescope in the Netherlands which became operational in 1956. He did so as employee of the funding foundation ZWO, the director of which, Banner, was prepared to make Hooghoudt's services available to ESO. The engineer W. Strewinski, an employee of the firm of Heidenreich and Harbeck at Hamburg, had been responsible for the design and construction of the

Schmidt telescope recently acquired by the Hamburg-Bergedorf Observatory under Heckmann's directorate. This telescope was completed in 1955 [10], after which Strewinsky created his own design bureau.

The EC's and Council's ideal would have been to engage both experts in close collaboration in the context of a design bureau, but attempts towards this end were not successful. To some extent this was due to their very different personalities and background, but there was also the dragging uncertainty in the realization of the ESO project in the early years which forced the engineers to undertake other projects besides ESO. Concern about the failure to build up a strong design bureau, first among the EC, then among Council, is a recurrent theme in their meetings [11]. Eventually the two engineers became engaged in separate parts of the project. Hooghoudt collaborated in general logistic planning and became responsible for the design and the construction of the 1-m Photometric Telescope. He also, after a visit of observatories in the United States, prepared for the May and October 1957 meetings of the EC a report on design considerations for a large telescope [12]. Strewinski became deeply involved in the design and construction of the ESO Schmidt telescope and in the early design stage of the large telescope, a natural follow-up of his early close collaboration with Heckmann.

### **ESO's Oldest Committee, the Instrumentation Committee**

In the earliest stage of ESO, when striving towards the Convention and conducting the site tests were the EC's main concern, the question of the future instrumentation was not yet prominent but the EC meeting of July 1958 did appoint an Instrumentation Committee (henceforth denoted by IC) consisting of O. Heckmann, A. Couder, R. Coutrez and J. Ramberg. However, little progress was made during the following two years. In July 1960 Fehrenbach was added to the IC and soon afterward, when the prospects for financing became more favourable, the IC became very active. Its meeting of January 3, 1961 at Paris was henceforth denoted as Number 1 in the long series to follow. Those up to the year 1970 are listed in Annex 4 A. The rapid succession of meetings early in 1961 reflects the enhanced activity. The IC soon created subcommittees for dealing with particular aspects of the instrumentation; their meetings will not be systematically recorded here.

By the time of the completion of the required ratifications of the Convention, early 1964, the IC had met twelve times. Its chairmanship alternated between Heckmann and Fehrenbach until Heckmann became Director per November 1, 1962. From then on Fehrenbach chaired the IC, a task to which he would dedicate himself over almost ten years, till 1972. The first Secretary



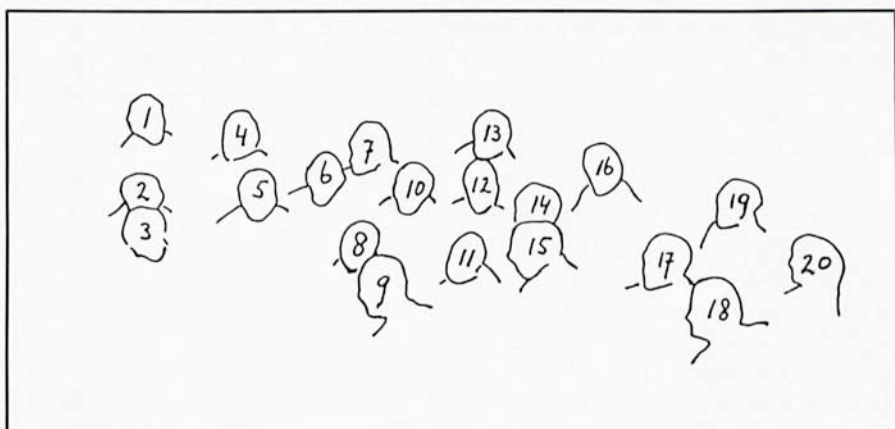

On February 5–7, 1963, shortly after the ESO Convention had been signed, the ESO Committee at the invitation of the CERN Directorate held its 19th meeting in CERN's Council Room. The photograph, taken during a tour of the CERN laboratories, shows:

1. P. Bourgeois (Belgium), 2. M. Deloz (Belgium), 3. A. Reiz (Denmark), 4. ??, 5. G. W. Funke (Sweden), 6. J.H. Bannier (Netherlands), 7. B. van Geelen (Netherlands), 8. W. Fricke (German Federal Republic), 9. C. Zilverschoon (CERN), 10. Ms. B. Rijken (ZWO, Netherlands), 11. A.B. Muller (Netherlands), 12. J.H. Oort (Netherlands), 13. Ch. Fehrenbach (France), 14. O. Heckmann (German Federal Republic), 15. H. Siedentopf (German Federal Republic), 16. ??, 17. B. Lindblad (Sweden), 18. ??, 19. ??, 20. Ms. T. Stuit (Kapteyn Laboratory, Netherlands).

of the IC was J. Ramberg who continued to act in this capacity until May 1966, long after he had joined the ESO Directorate.

Attempts to reconstruct the early proceedings of the IC are hampered by the fact that the ESO Historical Archives do not (yet) contain the minutes of the IC meetings. Fortunately, many of these minutes do form part of the Files of the ESO Head of Administration; lacking from these are minutes of meetings Nos. 3, 4, 5, 7 and 8 pertaining to the period April 1961 to June 1962 but these are, of course, interesting ones for the earliest developments. We therefore have to consult the reports on the IC's proceedings presented at the meetings of the EC which in most cases are fairly detailed. Information is also contained in a number of letters, for instance for meeting No. 3 in a letter by M. Minnaert to Oort and Blaauw of May 1, 1961 [13].

One of the first things the IC set out to do, was acquainting themselves with instrumentation developments elsewhere in the world, especially in the United States. This was in line with the policy the EC had stressed from the beginning and which had led to Hooghoudt's 1957 report, and the EC was encouraged by the generous way in which American institutes offered their help in building up ESO. Thus, immediately after the Assembly of the International Astronomical Union in California in the summer of 1961, Heckmann and Fehrenbach made an extensive tour along observatories in the United States and Mexico and visited prominent astronomers among whom I. S. Bowen, N. U. Mayall, D. Shane, A. E. Whitford and G. Haro. Their report [14] was discussed at the 15th meeting of the EC, in November 1961. It deals with questions of telescope design, the choice of the site, design of domes and, finally, with matters of general policy. From this last section, let me quote a few paragraphs:

*“Nos amis américains ont confirmé notre opinion que la responsabilité de toute la construction doit être prise par les astronomes. C'est à nous de décider les solutions de principe, d'accepter et de contresigner tous les plans.*

*— — — La réussite de nos collègues du Mont-Palomar s'explique en grande partie par la collaboration intime des astronomes et des ingénieurs travaillant tous à Pasadena et se réunissant très régulièrement.*

*Ces heureuses circonstances paraissent difficiles à réaliser par notre groupe européen. Une collaboration active de certains d'entre nous est néanmoins absolument nécessaire.*

*Il faut créer rapidement un bureau d'Ingénieurs — — —. La construction d'un Centre d'Etudes et probablement d'un laboratoire d'optique nous paraît également indispensable. — — —”.*

The first paragraph stresses the desirability of the complete involvement of the astronomers themselves in design and construction, and reflects a change in attitude sometimes encountered in previous telescope acquisition when much more of the ingenuity and responsibility was with the firm who delivered the telescope, sometimes even “off the shelf”.

The report also led to discussion of the question with whom the ultimate authority for decisions on matters of instrumentation should be; with the IC, or with the EC (or, later, the Council). This led to a task description for the IC implying a considerable degree of authority [15]:

“– 1. *The IC prepares all technical and financial aspects of the instrumentation in order to enable the Council to take the necessary decisions;*

– 2. *The IC makes all necessary instrumental and technical decisions within the frame of the budget and of the decisions of the Council.*”

Based on this task description, the Instrumentation Committee has played a very influential role in ESO's early development.

Naturally, because the large telescope and the Schmidt form the nucleus – the *raison d'être* – of ESO, their history should figure prominently in these reviews. Yet, we shall in the present article confine ourselves to the acquisition of the middle-size telescopes because these constituted the outfit on La Silla when the Observatory started regular operation in the late 1960's. The early histories of the Schmidt and the Large Telescope, both having become operational only in the course of the 1970's, will be central themes to be treated after I have dealt with the phase concluded in 1969. For the Schmidt, this will then also comprise the impressive associated survey projects.

## **The Middle-Size Telescopes**

One of the IC's first assignments was the specification of the telescopes which, as part of the “initial programme” of the Convention would be referred to as:

“c. *not more than three telescopes with a maximum aperture of 1 meter;*”  
and

“d. *a meridian circle;*”

For two of the three telescopes mentioned under (c) the IC meeting of April 1961 arrived at the following recommendations: one telescope designed primarily for photo-electric photometry – it would become known as the Photometric Telescope – and one telescope designed primarily for spectroscopic work – to become the Spectrographic Telescope. We shall first deal with these two, and subsequently see how the two remaining items were filled in with the GPO and the Astrolabe.

The procedure chosen by the IC for the realization of these two instruments reflects in an interesting way ESO's international character. It “planted” the planning and construction in the fertile soil of the various national interests. Thus, the Photometric Telescope became a concern of astronomers in the Netherlands, especially of those of the Kapteyn Laboratory at Groningen where photo-electric photometry was being developed by J. Borgman and collaborators. Also involved in this project was M. Minnaert of Utrecht who, with Borgman, acted as liaison with the IC. Similarly, the

Spectrographic Telescope was delegated to French astronomy, especially to the group around Ch. Fehrenbach at Marseilles and the Haute Provence Observatory. (The early planning of the Schmidt Telescope, to be described later, under the supervision of Bergedorf Observatory's director, Heckmann, reflects this same policy.) The policy of the EC to delegate development and realization of the middle-size telescopes to the above groups also resulted from a wish of the EC, to gain experience with different firms which might become useful for the construction of the large telescope [16].

### **The 1-Metre Photometric Telescope**

Early 1961 the group involved at the Kapteyn Laboratory formulated the most essential specifications for the design of this telescope [17]:

- optimum definition on the optical axis, but image quality outside the axis good enough for offset purposes;
- fairly rapid switching between widely different directions; for this purpose aiming at a short telescope tube;
- provision for heavy photometric equipment at the Cassegrain focus and for at least one more photometer or spectrograph at another (Nasmyth) focus, with the possibility of rapid interchange;
- in connection with these specifications, preference for a fork mounting.

These specifications had been the subject of consultation with the engineer Hooghoudt, and reference was made to the 90-cm light-collector type telescopes in use at McDonald Observatory and at the Leiden Southern Station as possible examples.

At the April 1961 meeting of the IC, offers for the mechanical parts had been received from six firms, but the IC developed strong preference for the Dutch firm of Rademakers to whom Hooghoudt was consultant engineer [18]. Decisions to this effect and on the choice of a fork mounting – not an English mounting – were taken at the June 1961 meeting of the IC [19, 20]. For the optics of the telescope offers were received from five firms covering a variety of glass sorts (including regular glass and low-expansion Tempax and Silica) [21], and at the June 1962 meeting of the EC the IC reported that orders had been placed: for the mechanical parts with the Rademakers-Hooghoudt combination, for the main mirror with Jenoptik in Jena and for the secondary mirrors with Hereaus. The construction was supervised for the IC by Borgman and Minnaert. Meanwhile, preparations were made for the design and construction of the main photometer for the telescope. The October 1962 meeting of the IC delegated this to Borgman, Minnaert and Sidentopf.

By the end of 1963, when the completion of the telescope would be a matter of little more than a year only, it had become clear that the telescope would not be used in South Africa. However, ESO was still a long way from

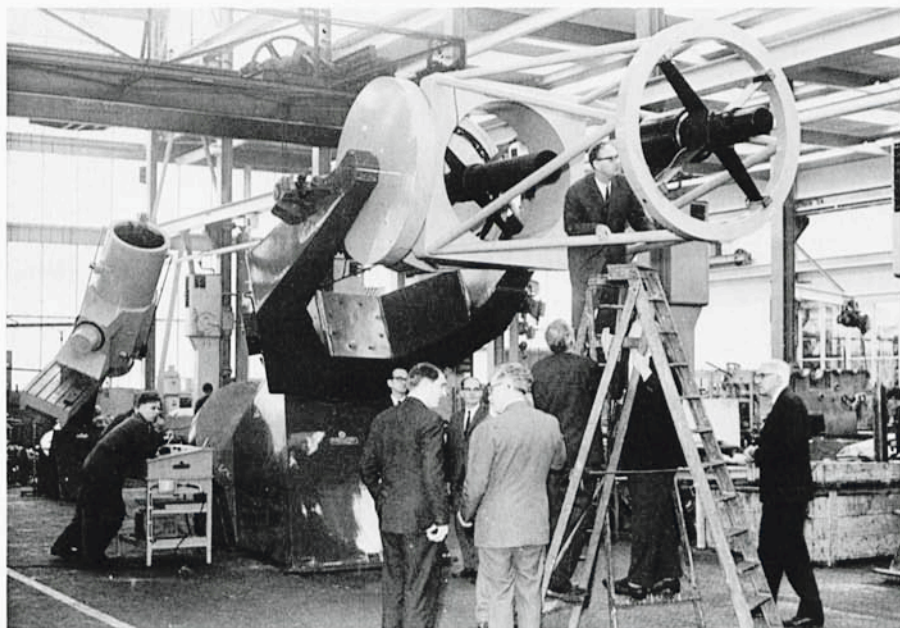

**The 1-m Photometric Telescope Nearing Completion.** By the end of the year 1964 the 1-m Photometric Telescope was almost ready to be delivered by the Firm of Rademakers at Rotterdam. It is shown here in their assembly hall on the occasion of a visit of the ESO group charged with the supervision of the construction. The photograph shows the group under the telescope tube; from left to right:

(1) unidentified; (2) J. Doornenbal, mechanic, employee of ESO; (3) J. van der Ven (at that time at Rademakers, later to be employed by ESO); (4) J. Ramberg, Assistant Director of ESO; (5) on lowest step of ladder, B. G. Hooghoudt, consulting engineer for ESO; (6) high on ladder, the author (Kapteyn Laboratory); (7) on lowest step of ladder, O. Heckmann, Director of ESO; (8) M. Minnaert (Utrecht Observatory).

From a photograph in the ESO photographic archives, marked "7 DEC. 1964".

completing its building programme in Chile, and potential users of the telescope were anxious to start soon. Therefore, it was suggested at the November 1963 meeting of the EC that a provisional, simple housing be acquired, and the May 1964 meeting urged an immediate decision on the matter. At that time the Convention had been ratified and the ESO Directorate had taken developments firmly in hand. It ordered from the United

States a dome of light construction, popular among advanced amateur astronomers (Astro-Dome), and this was mounted on La Silla in the course of 1966. In October and November of that year the telescope was mounted in this provisional shelter under the supervision of the engineer Hooghoudt and the firm of Rademakers (after the telescope had arrived in Chile in the middle of 1965 and then stored in ESO's warehouse at La Silla). In December 1966 the first photometric work was done by Borgman and collaborators with a simple photometer borrowed from the Kapteyn Laboratory. The ESO photometer for this telescope, constructed at the Kapteyn Laboratory, was mounted in the middle of 1967.

The Photometric Telescope has been described in detail by Hooghoudt in ESO Bulletin No. 1 of November 1966 which also contains a description of the photometer by M. de Vries. The telescope was moved to its permanent dome in the fall of 1968. The provisional dome has, since then, been used for several purposes and now (1991) houses the Leiden 90-cm telescope. A polarimeter for the 1-m telescope, installed at the end of 1968, was designed by A. Behr of the Hamburg Observatory and constructed under his supervision at Göttingen Observatory. A description by Behr is in ESO Bulletin No. 5 of December 1968.

### **The Spectrographic Telescope**

Main specifications for this telescope, drawn up by the group around Fehrenbach at Marseilles and Haute-Provence and initially also planned in the 1-metre category, included: provisions for using both the Cassegrain and the Coudé focus, and an English mounting [22]. Offers were received from the same six firms as for the Photometric Telescope and preference was then given to the firm of REOSC in Paris with whom the French group had experience in the delivery of spectroscopic equipment. REOSC had also built the GPO telescopes. As an alternative, the IC had considered acquiring a replica of the Kitt Peak 36-inch telescope with some modifications [23]. This idea was given up, however, when in 1961 an appealing alternative was suggested by the French: a duplicate of the 1.5-metre spectrographic telescope for which the Haute-Provence Observatory was about to complete design studies [24]. Construction of two identical telescopes would result in prices exceeding only little the price of one 1-m telescope. The French design, envisaging a Coudé focus only, would have to be slightly adapted. Doubts arose whether the increase of the "Convention-size" from 1 to 1.5 metre would be acceptable for the ESO Council, but this never became a serious problem.

The offer of REOSC was accepted in principle by the EC meeting of February 1963 and became final after the ratification of the Convention [25]. A glass blank for the main mirror was ordered from Sovirel, Parra Mantois,

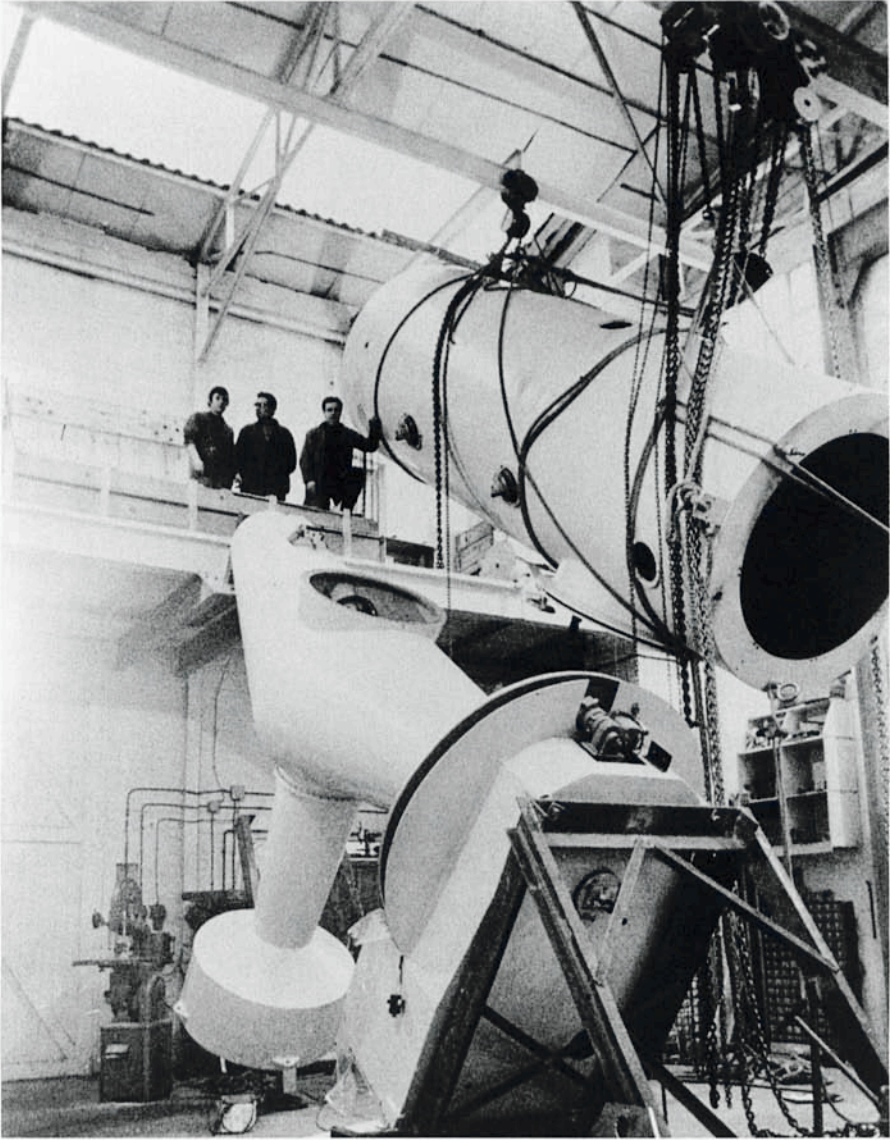

***The 1.5-m Spectrographic Telescope Nearing Completion.*** The Spectrographic Telescope in the assembly hall of the firm of REOSC, shortly before its shipment to Chile. From a photograph in the ESO photographic archives, marked "February 1968".

and blanks for the secondary mirrors from Corning. For the spectrographs, design studies – with strong contribution from the French group – were taken up by the IC early in 1963 and for the Coudé spectrograph the order was placed at REOSC in October 1965. The two telescopes were completed in the course of 1967 and the optics for ESO's copy tested in the Haute-Provence duplicate before being shipped to Chile. In the middle of 1968 the telescope was installed in its dome on La Silla under the supervision of the director of REOSC, A. Bayle. At the December 1968 Council Meeting Fehrenbach, just back from a stay on La Silla, could report that the instrument worked satisfactorily. For the first spectroscopic work, a Cassegrain spectrograph "Chilicass" was borrowed from Marseilles Observatory. It would be replaced in 1974 by ESO's own Boller and Chivens Cassegrain spectrograph. The Coudé spectrograph was finished by the end of 1968 and became operational on La Silla in the course of 1969.

A detailed description of the Spectrographic Telescope and the Coudé spectrograph was published by Fehrenbach in ESO Bulletin No. 3 of February 1968. The Cassegrain spectrograph is described by A. Baranne, E. Maurice and L. Prévot of Marseilles Observatory in ESO Bulletin No. 7 of September 1969 and by Maurice in ESO Bulletin No. 11 of February 1975. The Coudé spectrograph was described by H.J. Wood, B. Wolf (staff members of ESO) and E. Maurice (of Marseilles, formerly ESO staff member) in ESO Bulletin No. 11 of February 1975.

### **The GPO (Grand Prism Objectif.)**

We have seen in chapter II that around the year 1960 the GPO was introduced by its owner, the Marseilles Observatory, into the site testing activities in South Africa as one of the projects which would allow testing in combination with astronomical research. Eight years later, in the course of 1968, having meanwhile become ESO property, it started regular work on La Silla.

The ESO GPO was a duplicate of the GPO installed at the Haute-Provence Observatory (OHP). These twins represented an improvement of the smaller size instrument of this type at the OHP (the Petit Prism Objectif) developed earlier by Fehrenbach. Main motivation for this development had been the prospect of measurement of radial velocities of faint stars in a wholesale manner. The GPO consists of a photographic and a visual tube, each of 4 metre focal length. (See the photograph in chapter VII.) The photographic one has a doublet objective lens of 40 cm aperture, in front of which is mounted an objective prism of the type developed by Fehrenbach. This consists of two components, one of flint glass and one of crown-barium, and the angles of the two components are chosen in such a way that at wavelength 4175 Å the light traverses the combination without deflection.



Hence, by taking two exposures with the prism in opposite orientations, one obtains on the photographic plate for each star two nearly coincident spectra in opposite directions, and the relative displacement of the spectral lines in the two is a measure of the radial velocity of the star. For a more detailed description we refer to the article by Fehrenbach in ESO Bulletin No. 1 of November 1966.

The possibility that the GPO planned for South Africa might become property of ESO was alluded to already in the late 1950's at the time when – as we saw in chapter I – the prospects for French participation in ESO were low. For instance, it is mentioned in the report on a discussion on December 23, 1958 at Paris when Oort, chairman of the EC, discussed this participation with Danjon and Fehrenbach in the company of the French government representative Bayen [26]. The decision to incorporate the GPO into the ESO project was taken at the EC meeting of mid-July 1960. As described in chapter II, at that epoch plans for the Marseilles project had advanced to the stage where the choice of its location became desirable.

At this meeting Fehrenbach presented three possibilities and the related financial schemes: (a) Execution of the project without financial involvement of ESO, in which case it would be located in a town in the Southern Karroo offering logistic help but of no interest for ESO; (b) Execution at Zeekoegat, one of the potential sites for ESO, requiring financial support from ESO for various technical provisions; and (c) Incorporation of the project into ESO, implying financial contribution of ESO for these services and future ESO ownership of the telescope and associated equipment.

The French delegation at the meeting expressed strong preference for the last one of these possibilities as it would strengthen their efforts to persuade the French government to participate in ESO. The costs of the instrument already expended should be considered as part of France's first financial contribution. (The costs mentioned on this occasion were 330,000,- Francs; the amount of 60,361.96 US dollars was mentioned in the context of French payment at the July 1963 meeting of EC.) Delegates from most of the countries represented at the July 1960 meeting were in favour of the proposition for a variety of reasons: the GPO was considered a valuable asset to ESO; it opened the possibility to soon undertake an international research programme; and it would contribute to the site tests. At Heckmann's proposal, the meeting resolved that the GPO would be considered as one of the instruments belonging to the "initial programme" of the Convention.

The observational programme conducted by the Marseilles Observatory at Zeekoegat was concluded at the end of 1965. A series of publications by Fehrenbach and his collaborators M. and A. Duflot, A. Florsch and N. Carozzi in the Communications of ESO Nos. 1–7 over the years 1962–1966 are based on this work with the GPO. The mechanical parts were then shipped to Chile and the optics returned to France for overhaul. After the

telescope had been assembled and mounted in its dome on La Silla, it resumed its work with results that soon turned out to be of superior quality due to the better observing conditions on the new site.

### **The Astrolabe**

Among the tasks delegated to the IC was the definition of the instrument for positional astronomy. Initially, a meridian circle was the obvious choice, but meanwhile other observatories undertook such projects [27]. This led the relevant Working Group of the IC to modify the proposition and suggest at the June 1962 meeting of the IC the acquisition of an astrolabe.

A modern version of the astrolabe had been developed by Danjon and put to use at several French and other observatories. It has turned out to be a very useful instrument as it avoids to a large extent the systematic errors inherent to the meridian circle. Its limitation was in the restriction to bright stars, but for the main purpose, the improvement of the fundamental system with all-sky coverage, this was no serious drawback. The Dutch foundation ZWO possessed a Danjon astrolabe, left over from geodetical work in the Geophysical Year, and offered it for half the price [28].

In a letter of June 7, 1962 B. Guinot, head of the Astrolabe Service of the Paris Observatory and member of the Working Group, suggested to the EC that this astrolabe be made available for ESO [29]. As ESO's planning at that epoch was still in terms of South Africa, a location near the French station at Zeekoegat was envisaged. The switch from meridian circle to astrolabe was endorsed by the EC, and the acquisition proposed in the budget for 1964 as discussed at its February 1963 meeting [30]. By that time, however, the probability of establishing ESO in Chile had become so strong that the site remained uncertain for a while.

Once the decision in favour of Chile had become final, an interesting solution emerged: a collaborative agreement between ESO and the University of Chile, by which the astrolabe was to be installed at Cerro Calán Observatory near Santiago. The agreement dates from 29 April 1965 [31]. ESO provided the astrolabe with chronograph equipment and a building to house the instrument, and the University of Chile its chronometric facilities. But most important: the observations would be conducted and supervised by the staff of Cerro Calán. After overhaul in Paris, the instrument was installed on Cerro Calán in November and December 1965 with the collaboration of Guinot. Since then it has made, under the supervision of F. Noël, solid contributions to the Fundamental Reference System in the Southern Hemisphere and to research on the Earth's rotation; a first demonstration of the appreciable systematic errors in the southern FK4 right ascensions was published by Anguita and Noël in 1969 [32]. In ESO Bulletin No. 4 of June 1968 Noël describes the nature of the project and the first years of operation.

## ESO Chooses its Emblem

Not only heavy tasks kept the ESO Committee busy. After the Convention had been signed, it acquired its emblem for which at the October 1962 EC meeting Bannier presented some designs by the artist Mrs. G. M. Pot. The Committee had no problem in making up their mind; according to the minutes it chose the design "in which the stars show at their best". The emblem's stars – the Southern Cross – still show well, as is apparent from many ESO publications.

EUROPEAN ORGANISATION EUROPEENNE POUR  
SOUTHERN DES RECHERCHES ASTRONOMIQUES  
OBSERVATORY DANS L'HEMISPHERE AUSTRAL

Office of the Director  
Weidenbaumsweg 4  
205 Hamburg-Bergedorf  
Tel. 715711



29.10.1963

*In the fall of 1963 Heckmann established the first ESO Office at the Weidenbaums-  
weg in Bergedorf, after having first conducted ESO affairs from his Office at nearby  
Hamburg Observatory in Bergedorf. He then also began using ESO stationery with  
the letter head and logo as shown here.*



## **V. EARLIEST DEVELOPMENTS IN CHILE; 24 MARCH 1966: THE ROAD ON LA SILLA DEDICATED**

*"If we look around here, we see what has been achieved in the short period of a little more than one year. --- an oasis in the desert."*

From the speech by the President of the ESO Council, delivered at the dedication of the road on La Silla.

### **Introduction**

While in Europe Directorate and Council established ESO's administrative basis and the first telescopes were built or acquired under the guidance of the Instrumentation Committee, work in Chile proceeded equally energetically. Under the leadership of André Muller, since January 1, 1964 Superintendent for Chile, a great variety of tasks had to be taken up: building up staff for administration and construction, organizing office facilities, setting up temporary camps as basis for the activities on and around La Silla, learning to know the Chilean world of government and provincial authorities and of contractors, etc. A challenging but demanding assignment! For it is one thing to build up an organization in one's own country with its well-known legal structure and social traditions – but another one to do so in a foreign country with unfamiliar language, different customs and different rules.

Two important "happenings" in Chile offer themselves as mile stones for the historical account. One, in March 1966, is the dedication of the road to the summit area of La Silla, the completion of which was a natural inducement for Council to have its meeting in Chile. The second one, three years later, in March 1969, is the dedication and celebration of the completion of the first stage of the constructions on La Silla, when the middle-size telescopes had become operational and the Headquarters building in Santiago had become available: these celebrations coincided with Council's second meeting in Chile. In the present chapter I shall follow developments leading up to the first one of these events: the period 1964–1966.

Early in 1964, when there still was the prospect of a combined AURA-ESO settlement, Muller was engaged in work on the mountain Cinchado within the AURA territory, south-west of Tololo. However, these activities were rather abruptly terminated after the working group of Heckmann, Fehrenbach, Rösch and Muller as described in chapter III, had explored

## V. EARLIEST DEVELOPMENTS IN CHILE

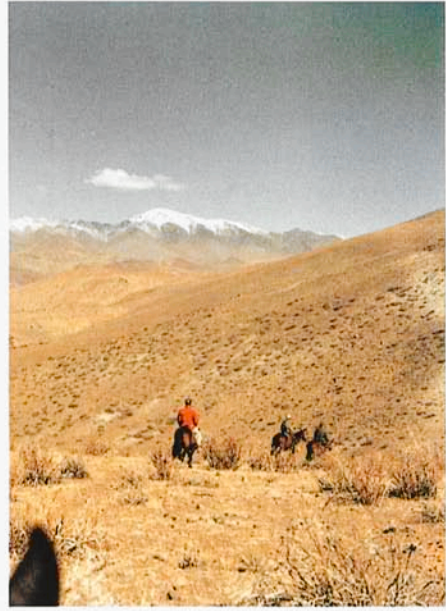

*In October 1964, Ch. Fehrenbach as Chairman of the Instrumentation Committee, the architect F. W. de Vlaming and the author, together with ESO Staff, explored – still on horse-back – La Silla for planning of the location of the telescope buildings and the associated facilities. In both photographs, from left to right, de Vlaming, André Muller and Otto Heckmann.*

*Photographs by the author.*

possible sites outside the AURA domain and found La Silla. This switch had been no small matter: as mentioned in the ESO Annual Report for 1964 (p. 13), the work on Cinchado had implied road construction and erection of temporary housing requiring 500 mule loads of building material to be transported to the top of Cinchado, much of which had to be brought down again . . . From then on, all effort had to be concentrated on La Silla.

Main sources for the present account are: (a) a series of three reports by Muller to the ESO Directorate, covering the period up to the middle of 1965, copies of which were sent by Muller to J. H. Oort as President of the ESO Council [1]; (b) reports presented by the Director, Heckmann, to the Council and his letters to Oort in which he reports on his visits to Chile in March–April 1964, August and October 1964, March–April 1965, and September–October 1965 [2]; (c) the minutes of Council and FC meetings in the FHA; and (d) the Annual Reports for the years 1964 to 1966.

## **The Acquisition of the La Silla Territory**

On October 30, 1964, a contract was signed in Santiago between ESO and the Government of Chile for the purchase of an area of 627 square kilometres including the mountain La Silla [3]. Within more extended Government property the ESO domain had been staked out as proposed by ESO, with most of the boundaries following dry riverbeds (called *quebradas*); see map B. The site is situated in the border region of the provinces Coquimbo and Atacama, pertaining to the communities of Vallenar and La Higuera, respectively. The contract defines the contours of the property by means of the geographic longitude and latitude of the five points A to E marked on map B. The relatively low price ESO paid for the territory, 8000 dollar [4], reflects the interest on the part of the Chilean Government in having the Observatory established in their Country.

Preceding the transfer, such questions as the accessibility of the mountain, the possible amount of water supply, the fate of the few settlers on the territory, and the elimination of existing and potential claims for mining rights had to be cleared. Therefore, already in the intervening months between the choice of La Silla and the conclusion of the contract, much activity took place in the area, to some of which we shall return below. Also, an unexpected obstacle was encountered when, notwithstanding the property rights of which the Government was convinced, it turned out that ownership in the southern part of ESO's area, forming part of the Estancia Chingoles, could be claimed by a private owner, the Urrizar family. In order to avoid time-consuming legal procedures, ESO came to an agreement with the Urrizar owners, buying for 6000 dollars this part of the territory once more [5] – still at a quite reasonable price. Moreover, the Urrizar family granted ESO the use of 50% of the yield of a neighbouring water source on their territory if the need might be. More particulars on this episode are given in Heckmann's account [6].

Parallel to the acquisition of the La Silla territory progressed that of the site in the city of Santiago on which ESO planned to build its Headquarters, and the purchase of the Guesthouse. We shall return to the History of the Headquarters in the next chapter, and first follow developments around the Observatory.

## **Building up the Observatory; First Step: Road and Camps**

As a home base for the work on the Observatory site, ESO – like AURA – established an Office in La Serena, capital of the Province of Coquimbo, where the necessary contacts could be entertained with government services and contractors; it also was the nearest town with schooling facilities for young children of ESO staff. These latter included the Muller family who

V. EARLIEST DEVELOPMENTS IN CHILE

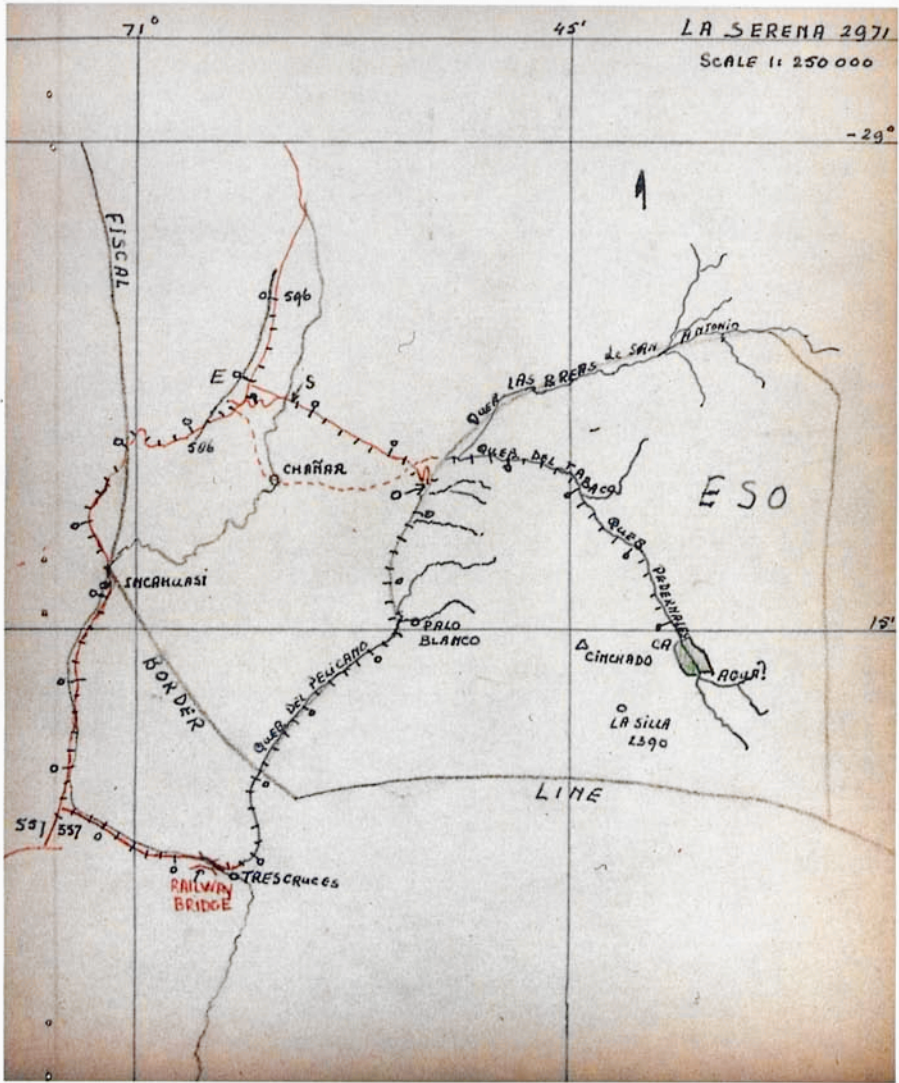

**Map A:** Reproduction – at about half the original size – of a map drawn by A.B. Muller and accompanying his report to the ESO Directorate of June 29, 1964, describing explorations to find the best access road to La Silla.



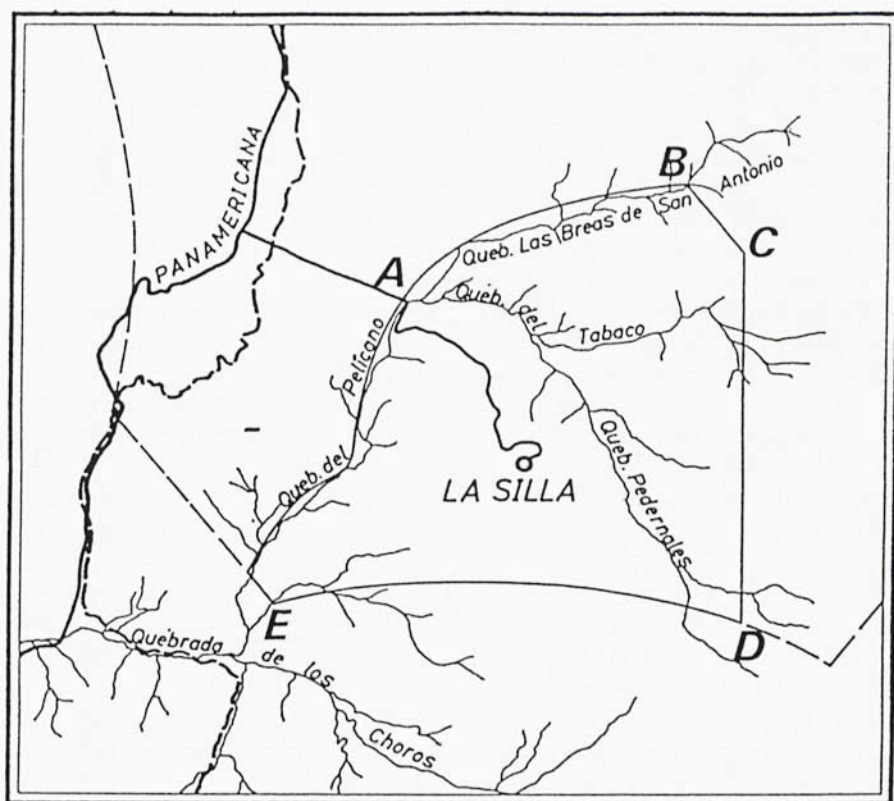

**Map B:** The ESO property as defined in the purchase contract between ESO and the Chilean Government of October 30, 1964. The boundaries are fixed by the geographic co-ordinates of the points A, B, C, D, E and the centrelines of the quebradas Pelicano and Las Breas de San Antonio.

Thin drawn line: boundary of ESO property.

Thin dashed line: boundary of Government property of which the ESO territory formed part.

Heavy lines: Panamerican Highway and access road to La Silla.

Heavy dashed line: Railroad track.

Adapted from Figure 2 in ESO Annual Report 1964.

moved from Holland to La Serena in March 1964. At a distance of 480 km from Santiago, the capital of Chile, La Serena became the natural centre from where all work had to be co-ordinated. Yet, with La Serena still being 150 km distant from the summit of La Silla, construction programmes as well as the first operation of the Observatory would also require extensive provisional facilities for living quarters, construction work, storage and administration in the La Silla area itself. Therefore, camps had to be erected at its base as well as on the summit. But the very first question was, of course, how to get there!

The first one of Muller's reports, of June 29, 1964, contains a hand-drawn map of the La Silla area which we reproduce here at about half the original size (map A). It must have been based on the Government map No. 2971, copy of a relevant section of which is in EHA-I.C.3.1. which also contains contour maps of this area. Muller's map serves well to illustrate the earliest moves.

When Heckmann, in his letter to Oort of April 21, 1964 quoted in chapter III, wrote about Cinchado-Nord (the official name of La Silla in the mapping of the Instituto Geográfico Militar) as being the most interesting of the mountains surveyed and accessible from the Panamericana via about 35 km primitive road, he referred to a different track than what would become the present road between the Panamericana and Camp Pelicano. [N.B. André Muller informs me that the name La Silla, meaning The Saddle, was at that time already used by the carboneros (charcoal burners) in the valleys around the mountain.] The track mentioned by Heckmann branched off from the Panamericana at point 557 indicated in map A and entered Quebrada Pelicano via Tres Cruces, passing over a railway bridge as marked in the map. This bridge would have been a difficult obstacle for future transport. However, Muller's first report states: "*There does exist a much better possibility. A reasonably good track was found by Muller during his investigation of the area Chañar on the 18th and 25th of June. On the 18th the road to Chañar was found, but the track indicated on the map from Chañar to O does not exist. On airphotographs a road was found from the Panamerican Highway to O and this track was recognized by him while flying on the 24th from Copiapo to La Serena. On the 25th a successful attempt was made to get to point O and also to CA in the Quebrada Pedernales. --- the first time it was a bit difficult to get from the new road to the track EO, but later three different tracks were found from the new road to the access road to O. --- It is clear that the road to Pedernales and later to La Silla will run over the points E to O. To get from O to the top of La Silla, ESO will have to construct a road of more or less 40 km length. ---*" As visitors of La Silla arriving from the Panamerican Highway nowadays will note, their path to Camp Pelicano leads along the, formerly very primitive, track EO.

Whereas Muller's last remark refers to the definitive road to the top, a



**June 1965:** *First successful water drilling near Camp Pelicano.*



**June 1965:** *Road construction on La Silla.*

*All four photographs from negatives in the ESO Historical Photographs Archives.*

provisional one was a first requirement for the construction work. Also immediately required was a source of water, even if it were to be used only temporarily. One source was located with the help of the geologist O. Castello of the Instituto de Investigaciones Geológicas in the area marked CA on the map. Simultaneously, exploration in the La Silla area for finding the most suitable track for approaching the top was carried out by F. Unz, the collaborator of Siedentopf who had carried out atmospheric turbulence measures at Zeekoegat and subsequently did similar work on Cerro Tololo; he recommended to approach the top from the same area, i.e. from CA.

Thus, originally it was planned to reach the summit area from point O along a primitive road through Quebrada del Tabaco and Quebrada Pedernalis to the area CA and from there along about 5 km of new, provisional road to the top.

This project was not carried out, however. Muller erected at the foot of the mountain, near the junction of Quebrada Pelicano and Quebrada Las Breas de San Antonio, at altitude about 1000 m, the principal base camp for the operations: Camp Pelicano, close to the position where it still is today. From here he chose a new track that led straight into the slopes of the mountain, not using the tracks in the Quebradas at all. The definitive road, as we know it now, deviates little from this provisional one. Construction of the road in provisional form started in March 1965 and around the middle of that year it was good enough to allow heavy construction vehicles to reach the summit area. Also, the sites for the telescopes and other buildings were then levelled.

This early stage did not yet include the road to the top reserved for the 3.6-m telescope, neither the levelling of this top; the road went as far as the area around the site for the Schmidt telescope. Putting this road in definitive shape, including asphalt surfacing and widening it here and there would be a matter for the future, when no heavy traffic would spoil the surface any more. Construction works for the 3.6-m telescope were still a matter for the future . . . Thus, late 1965 ESO was ready for the dedication of its road, to be combined with Council's first meeting in Chile. A report on the road construction on La Silla has been published by H. O. Voigt in ESO Bulletin No. 3 of February 1968. The engineer Voigt had been appointed per October 1, 1964 as Assistant Director for the construction activities. But before arriving at the dedication festivities, we must turn to other aspects of the early work.

### **The Problem of the Mining Rights**

When Council decided on May 26, 1964 to choose La Silla for the Observatory, and consent on the part of the Chilean Government could be taken for granted, this did not yet imply that Muller and his collaborators could freely move and get to work on the mountain. Their work was still hampered by legal aspects connected with the elimination of existing or potential claims for mining rights. A few explanatory remarks on this subject are in order here.

In Chile, where much of the economy depends on the production of its mines, special laws protect their exploration to the effect that the owner of land like that around La Silla is not automatically also the owner of the minerals occurring below the surface: other parties may claim the right to explore mines on such territory, a right to be granted by the Government. This paramount importance of mining explains why, for example, the very

first paragraph of the first article of the contract for the purchase of the La Silla territory reads: “No mining operations shall be conducted without the authorization of the Head of State of Chile – – –.” For ESO it was – and still is – necessary to avoid mining on its territory because of the resulting disturbance of the atmosphere by dust and illumination. ESO therefore had to claim itself the right for exploration whenever it was demonstrated by another party that minerals could be found in critical parts of its domain. Claiming mining rights involves payments to the Government, and the rights thus guaranteed are of temporary nature only and must be re-obtained at repeated costs. As mining rights can be sold – for instance by prospective explorers to ESO – it is obvious that there is a strong speculative aspect against which ESO had to defend itself continually.

This defense has been one of the tasks of ESO’s legal advisors in Chile and it was, from the outset, one of the Directorate’s main worries as is evident from Heckmann’s reports to Council, for instance those after his trips to Chile in August and October 1964 and March – April 1965. Early in 1964, the clearance of mining claims slowed down the activities of Muller’s group on the mountain [7] because preparations for road construction might awaken the interest of outside parties in searching for minerals in those particular areas. Characteristic is the following section of a letter by Heckmann to Oort of April 3, 1965 [8]: “6. *Wir haben mit den Minenrechten mancherlei Mühen. Das gefährlichste lag unmittelbar auf dem Gipfel von La Silla. Es war vor uns da, wurde aber, als wir kamen, in seiner Lage und Orientierung so fixiert, daß es uns sehr störte. Ich war für ein paar Tage sehr verzweifelt. Unser Minen-Advokat Urrutia hat aber vor Gericht in La Serena dieses Minenrecht mit Erfolg angefochten. – – –*”.

## **The Building Programme; Early Architectural Planning**

Anticipating developments after the ratification of the ESO Convention (of early 1964), the ESO Committee in its meeting of February 1963 installed a Working Group for Buildings under the Chairmanship of the ESO Director. It was to draft a programme for the erection of the Observatory (domes, offices, hostels, workshops, etc. and time schedule) in accordance with the wishes of the astronomers in the ESO countries. This led to a Memorandum of November 8, 1963 which was accepted by the ESO Committee in its meeting of November 15, 1963 and endorsed after the ratifications. At the same time, the Directorate prepared a “Short Memorandum on the ESO Building Activity” [9] dated October 7, 1963. (Note that at that time the choice of the Observatory site had not yet been made.) The memorandum was also meant for information of potential construction firms.

It was proposed to realize the Observatory in two steps. The first of these, to be finished “about 1966”, should cover everything associated with the

installation and operation of the middle-sized telescopes described in the previous chapter together with the Schmidt telescope, and the second, to be finished "about 1970", should cover the realization and operation of the 3.6-m telescope and the associated facilities. The first stage was to include on La Silla such elements as the Boarding House, Workshop and technical facilities and a few residences, and the second stage, apart from the building for the large telescope, extensions required for the use of this telescope. Also included in this planning was the Headquarters Building in Santiago, correspondingly subdivided in a first and second stage.

As part of this planning, it was necessary to obtain architectural designs and cost estimates. ESO therefore contracted the firm of the Dutch architects F. W. de Vlaming and H. Salm who, a. o. projects, had been associated with the radioastronomical establishments in the Netherlands [10]. De Vlaming visited the building sites in October 1964 in the company of ESO staff and astronomers including Fehrenbach as President of the Instrumentation Committee and the present author, the latter particularly in connection with the housing of the 1-m telescope which was expected to soon be operational. The



**Camp Pelicano, January 1966.** At lower right, the access road from the Panamerican Highway. At left, the road leading to the summit area of La Silla. At 1/3 from top, to the right of the middle of the photograph, the earliest, provisional Camp settlement. Photograph by R. Holder in the ESO Historical Photographs Archives.

preliminary designs of de Vlaming have provided a first basis for the planning and the general lay-out of the Observatory, but the rather ambitious, "representative" nature of his designs have ultimately in some cases been replaced by more sober implementations.

A rather detailed description of the planning by the Working Group for Buildings and the Directorate has been published in *ESO Bulletin* No. 2 of August 1967 by J. Ramberg, at that time Assistant Director of ESO. This article also describes the status of execution by the end of 1966: the design work by the architect and his associates had been completed, consulting engineers of the construction firms had been associated with the project, and offers from construction firms were being negotiated. In many respects, the execution of the project was to become a joint European-Chilean undertaking, including a Chilean architect and Chilean firms for the constructions.

### **Progress over the Years 1964–1966**

The situation in the La Silla area at the end of 1964 is – too modestly! – summed up as follows in the Annual Report for 1964:

*"a) Office in La Serena, functioning with five persons active.*

*b) Camp Pelicano, with two old houses and four new ones installed, a carpenter's workshop in use, fifteen persons active, animals' camp installed and functioning with five horses and six mules, two wells ready with one pump installed.*

*c) Road project [i. e. planning and lay-out of the road], ready from camp Pelicano to the top of La Silla."*

At that moment the small group of ESO employees in Chile consisted of André Muller as Superintendent, with Hans-Emil Schuster, a former pupil of Heckmann, appointed per October 1, 1964 as Assistant-Astronomer; furthermore, there were the Camp Supervisor Hernan Carrasco and five more technical and administrative staff [11]. We also reproduce here from the ESO Annual Reports for the years 1965 and 1966 the schematic representations of the structure of the organization, exhibiting its rapid expansion after 1964.

The year 1965 saw progress of work in the La Silla area on many fronts. Apart from the major accomplishment, the road construction, Camp Pelicano began to take its more definitive shape after having served initially in provisional form. For the power supply, which had been obtained provisionally from a small portable generator brought from South Africa, a power house was erected at Camp Pelicano with a battery of generators whose output was to grow as the demand would increase. On the summit area of La Silla a small temporary camp was constructed, including storage room, some living quarters, a power house and a temporary workshop. A beginning was made with the building for the GPO telescope which would soon be transferred from South Africa to La Silla. Also, a radio connection between Camp

V. EARLIEST DEVELOPMENTS IN CHILE



*Building up ESO in Chile: The structure of the Organization as shown in the ESO Annual Reports for 1965 (top) and 1966 (bottom).*

Pelicano and the summit Camp was installed. Meteorological observations were conducted throughout the year. They included measures of cloudiness, wind velocity, wind direction, temperature and humidity and were reported by Muller in the first issue of the *ESO Bulletin*, of November 1966. (Meteorological reports by Muller for subsequent years have been published in Bulletins Nos. 3, 4 and 7 for the years 1966, 1967 and 1968.)

For supplying the Observatory with water, a number of boreholes were



drilled near Camp Pelicano in 1965 and their output was promising, but the really important question was, of course, whether the yield would remain sufficient under the continual use by the Observatory in operation. Checks in 1966 and thereafter showed that the use would not be exhaustive. As the visitor of La Silla notices, the water is transported from the level of Camp Pelicano (at about 1000 m) to the summit at about 2400 m in three steps, with two high-pressure pumps in between (at altitudes 1500 and 1950 m). The construction of the water and power supply have been described by S. Klingenberg in *ESO Bulletin* No. 3 of February 1968.

## **Organizational Structure and Employees**

By the time Muller and his collaborators were ready for the dedication of the road in March 1966, the activities in Chile were grouped in three departments: an administrative one, one for constructions, and one dealing with miscellaneous tasks including meteorological observations; this latter under Muller himself together with Schuster. Much of the activity centred on La Silla and around Camp Pelicano. Engaged in Camp Pelicano had become also Albert Bosker whom we encountered earlier as one of the assistants of Muller during the site tests in South Africa. Bosker joined ESO this time on more permanent basis, from February 1965, first as assistant Camp Boss, and from November 1965 as Storekeeper (Chief Bodega) at Pelicano. Under the Camp boss fell matters of board and lodging for the workers at La Silla, transport, storage, radio links, stable boys, and the animal population of horses and mules still used for patrolling the property. In the course of 1966 a second, now more definitive Camp was erected near the top of La Silla under the same supervision, for the housing and board of part of the construction workers.

The administrative department had an office in La Serena, with Arturo Cuthbert as bookkeeper, but it became more and more centred on Santiago where it was supervised per January 1, 1965 by the Assistant Administrator H.J. Straatman. From the middle of 1965 all administration was headed by R. Plentl under Muller's supervision. The department of constructions fell under the supervision of H.O. Voigt mentioned before and the engineer R. H. G. Holder who joined ESO per May 16, 1965. Of the other employees let me mention here Jan Doornenbal, who after having collaborated in the site tests in South Africa joined ESO from September 1963 as a mechanic for the construction of the ESO photometer at the Kapteyn Laboratory, and from January 1, 1965 in La Serena, and Mrs. Christa Euler who became a secretary at the Santiago Office per March 1, 1966 [12]. Naturally, there were many organizational links between La Serena and Santiago and with the corresponding divisions within the Office of the Director in Hamburg-Bergedorf.



**January 1966:** Aerial photographs of first stage of road construction on the summit of La Silla. South is at the top, north at the bottom. Note that the road did not yet extend to the main and secondary tops in the southern background of the left-hand photograph, now occupied by the 3.6-m telescope and the NTT. The more detailed right-hand photograph shows that the only telescope building under construction was the one for the GPO.

Photographs by R. Holder in the ESO Historical Photographs Archives.

### **The ESO Guesthouse**

In the course of 1964, with more and more activity developing in Santiago, the need was felt for a *pied à terre* in this city, rather than always having to use hotel accommodation. A quite satisfactory solution was found by the acquisition of what has become the ESO Guesthouse, formerly belonging to the Spaarwater family. Situated in the Vitacura district, not far from the future Headquarters, with many rooms and surrounded by an attractive garden on a lot of 0.44 ha, it could easily be transformed into both offices for administration and temporary lodgings. In its meeting of December 1964 Council approved the purchase, and the transaction was concluded in March 1965. In May the Director could report that the house was being adapted to



b      c      d      e

↓      ↓      ↓      ↓



a →

← f

**October 1966, first constructions on La Silla.**

Top: Overview. Bottom: Close-up of the central part of the construction site.

- (a) Camp for the construction workers.
- (b) The lower part of the building for the GPO with next to it the provisional mechanical workshop.
- (c) Foundation for the 1-m telescope building.
- (d) Foundation for the 1.5-m telescope building.
- (e) The temporary dome of the 1-m telescope.
- (f) Site preparation for the Hostel.

Photographs by R. Holder in the ESO Historical Photographs Archives.

ESO's needs, and was run by the housekeeper Mrs. Carmen Fritsche under the supervision of Mr. J. A. Briggs, Assistant Administrator in the Santiago office [13]. She was soon succeeded by Mrs. Hilde Fritsch. The hospitality and good care of the late Mrs. Fritsch until her retirement in the late 1970's will be gratefully remembered by many of ESO's staff members and visiting astronomers of those early years.

### **Council Meeting and Dedication, March 1966**

The activities described before reached a milestone with the dedication of the road on La Silla and Council's first meeting in Chile. (Also the FC met there these days.) ESO's road was an excellent achievement and worthy of a celebration indeed. Over its total length of 20 km from Camp Pelicano to the summit it has no inclination exceeding 12%, no sharp curves, and the average width at the time of completion was 5 m. Never were serious obstacles encountered by transport of heavy and large parts of equipment in the later stages of building up the Observatory. In addition to the 20 km mentioned, about 5 km of access road had been paved to the various buildings on the summit. For the connection of Camp Pelicano with the Panamerican Highway, 17 km of the existing but quite primitive road had been improved as a joint project of ESO and the Chilean Public Works Department.

Council members arrived in Santiago on March 21 and left in the beginning of April. On March 23 they went to La Serena by bus and the next day arrived at Camp Pelicano. Here, in the morning of the 24th, the dedication ceremonies took place in the presence of many authorities and guests. They started with the benediction by the Archbishop of La Serena, after which ESO's President G. W. Funke delivered the inauguration speech in which he stressed the growing importance of Chile as a centre of astronomical activity. Funke's speech, with translation into Spanish, has been published in *ESO Bulletin* No. 3 in February 1968. Let me quote a few of Funke's words:

*"If we look around here, we see what has been achieved in the short period of a little more than one year. Under the able leadership of Dr. A. B. Muller, Europeans and Chileans have created an oasis in the desert. --- We have to express our gratitude to every astronomer, technician and workman who cooperated in the joint effort. In particular the Chilean obrero has to be mentioned, because his readiness to work under the exceptional conditions of this area, his untired willingness to undergo the hardship --- made our work possible."*

The ceremonies were concluded with a speech by the Intendente (Governor) of the Province of Coquimbo. Subsequently, Council and visitors drove by bus and car on the newly opened road to the summit area of La Silla. Council stayed overnight in Camp Pelicano and the next day visited places on

the ESO domain. They made once more the trip to the summit, but this time in the now old fashioned but more romantic way – on horse-back.

During the next days Council visited the AURA site on Cerro Tololo and a copper mine in the vicinity of La Serena, before returning by bus to Santiago on the 29th. March 30 scheduled a visit to the University of Chile's Cerro Calan Observatory and a general reception, and on March 31 and April 1 Council held in Santiago its 6th meeting. For most of the Council members it must have been their first visit to South America. Neither the minutes of the Council meeting nor the ESO Annual Report tell much about these events, but the relevant documents are found in the section of the ESO Historical Archives originating from Oort [14], one of the participants.

Visits to Chile of Council, of FC and of other ESO Committees always have been extremely useful for a proper evaluation of the planning and the operation of the Observatory. The minutes of this first Council meeting in Chile reveal considerable, unforeseen rediscussion of the geographic structure of the establishment in Chile, although no fresh points of view were presented. An understandable development, because the complexity of the geographic structure of the organization and the enormous effort of the ESO staff required for its realization could only now, *in situ*, be fully appreciated by Council.

PROGRAMA DE LA INAUGURACION DEL  
OBSERVATORIO DE ESO EN LA SILLA  
25 de Marzo de 1969 - 11.30 horas

- 1.- *Bienvenida por el Director General de Eso:  
Prof. Dr. O. Heckmann, Hamburgo y  
Santiago.*
- 2.- *Discurso por el Vice-Presidente de la Unión  
Internacional de Astronomía, Prof. Dr.  
George Sahade, La Plata.*
- 3.- *Discurso por el Ministro de Educación de  
Suecia, Sr. Olof Palme.*
- 4.- *Discurso por el Presidente del Consejo de  
Eso, Dr. Jan Bannier.*
- 5.- *Discurso por el Ministro de Relaciones  
Exteriores, Don Gabriel Valdés S.*
- 6.- *Bendición por el Arzobispo de La Serena,  
Monseñor Juan Francisco Fresno.*
- 7.- *Almuerzo a las 13 horas.*
- 8.- *Visita a cúpulas e instrumentos.*
- 9.- *17 horas: Partida de los buses.*

## **VI. FURTHER DEVELOPMENTS IN CHILE; 25 MARCH 1969: THE FIRST PHASE DEDICATED; THE INTRODUCTION OF NATIONAL TELESCOPES**

*"La construcción del observatorio de La Silla — — es un ejemplo notable de lo que se puede lograr por medio de eficiente y, sin duda trascendente, cooperación internacional."*

From the speech by Olof Palme on behalf of the ESO member states at the dedication of the Observatory.

### **The Inauguration**

On March 25, 1969, an audience of more than 300 people: members of the ESO Council, Government officials, representatives of AURA, CARSO, IAU and CERN, other guests and staff members of ESO were assembled in the large dome on La Silla which years later would house the Schmidt telescope. They celebrated the completion of the first phase of the construction programme. Three years and one day earlier, the road to the summit had been dedicated and an extensive building programme then lay ahead. Now, the Observatory entered its full operational phase with the middle-size telescopes.

Many speakers marked the occasion: after an introduction by ESO's Director, O. Heckmann, they were, in this order: J. Sahade as Vice President of the International Astronomical Union; Olof Palme, Minister of Education of Sweden; J. H. Bannier, President of the ESO Council; Gabriel Valdés S., Minister of Foreign Affairs of Chile; and Eduardo Frei Montalva, the President of the Republic of Chile; after which the Archbishop of La Serena, Msgr. Juan Francisco Fresno pronounced the benediction. The inauguration proper was pronounced by President Frei, who for this occasion had landed by helicopter on La Silla. At the lunch following the ceremonies, the audience was addressed by the French Minister of Education, Jacques Trorial.

The texts of the addresses, with translations into or from Spanish, have been published in *ESO Bulletin* No. 6 of July 1969. Olof Palme spoke, in Spanish, on behalf of the six ESO Member States. Let me quote some parts of his speech in the English translation:

*"The erection of the La Silla Observatory — — is not only of vast importance for the future of astronomical research, but also a striking example of what may be achieved through efficient, and truly far-reaching,*

VI. FURTHER DEVELOPMENTS IN CHILE

*international cooperation. — — — Scientific progress and international cooperation are important instruments in the realization of the objectives of any modern society.”*





On the occasion of the inauguration several other events, among which Council's second meeting in Chile, took place to which I shall return later in this chapter. Let us first look back upon the developments that had led to the completion of the first phase. In the course of the three years since the dedication of the road, buildings for the telescopes, the Hostel, dormitories, workshop, storage space, etc. had been erected and in Santiago the Headquarters building had been completed. We shall not follow these developments here in detail, only main lines will be sketched. The photographs accompanying this article show the changing face of La Silla over these years.

### **Developments on La Silla, 1967–1969**

An interesting report on the situation early 1967 results from a visit to La Silla of the Dutch Ambassador in Chile, D. G. E. Middelburg on 17 February 1967 [1]. He was one of those in the European Diplomatic Corps in Santiago who followed ESO's activities with great interest and active support, and he developed a special relation to ESO through his son Frank [2]. From the Ambassador's report to the Dutch Ministry of Foreign Affairs I quote a few lines in translation from Dutch: “--- *On the mountain I met considerable activity. Provisional lodgings, dining and office rooms are in use since some time. A Dutch telescope is housed in a provisional steel dome. Concrete foundations are now being laid for three large domes and for a hostel. --- As an illustration of the considerable problems that have to be solved, let me*

### **INAUGURATION CEREMONIES ON LA SILLA**

*On March 25, 1969 inauguration ceremonies took place on La Silla, celebrating the completion of the first construction phase of the Observatory.*

**The top photograph** shows the President of the Republic of Chile, Eduardo Frei Montalva, pronouncing the inauguration. It took place in the dome which, several years later, would house the Schmidt telescope, before an audience consisting of the ESO Council and many guests among whom Chilean government authorities, representatives of other scientific institutes, and ESO staff.

**The bottom photograph**, taken during one of the preceding speeches, shows in the front row from left to right: Otto Heckmann, Director General of ESO; Gabriel Valdés S., Minister of Foreign Affairs of Chile; Olof Palme, Minister of Education of Sweden; President Frei; and Hendrik Bannier, President of the ESO Council.

*From a series of photographs in the ESO Historical Photographs Archives.*

VI. FURTHER DEVELOPMENTS IN CHILE



**VISIT OF AMBASSADOR MIDDELBURG, FEBRUARY 1967**

**Top photograph:** Fr. Dossin (ESO Staff astronomer), Mrs. Heckmann, and Mrs. Middelburg on the way to La Silla.

**Bottom photograph:** ESO's Constructors Board on the Panamericana Highway at the exit to Pelicano.

Photographs by Ambassador Middelburg in EHPA.

*mention that all personnel, all building materials, all tools, supplies and provisions have to be brought from far away. --- The relation to the Chilean authorities is very good. Weak points in the organization are: communications and personnel. --- La Silla has neither telegraph nor telephone connection. By means of their own radio telephone emitters and receivers ESO has created a provisional connection Santiago-La Serena-La Silla. --- One can imagine what delays and misunderstandings may arise when passing on technical and sometimes complicated messages to collaborators of different nationalities ---. Personnel problems arise partly from these poor connections. Obviously [these] are unavoidable for an organization manned with Dutchmen, French, Belgians, Germans, Swedes and Chileans ---. Difficulties were also encountered with young astronomers, coming from the intimate European academic circles and transferred to the loneliness of an almost uninhabited desert. Some of these lack the pioneering spirit of their elder colleagues ---. For this problem, too, the ESO Direction may well find a solution in due course. --- The ambitious and daring project --- develops favourably ---."*

By the end of 1967, Camp Pelicano had been extended with several facilities including a clubhouse and a soccer field for the personnel. On La Silla, a Camp had been added for the personnel of the construction firms, and the buildings for the 1-m, 1.5-m and Schmidt telescopes were almost completed as well as the heating plant. Construction of the GPO building had been started again after a lengthy interruption due to road constructions in the neighbourhood. Also the building for the first of the "national telescopes" (about which we will have to tell more below), the one of the Bochum Observatory, was completed except for the mounting of its dome. For the purpose of measuring atmospheric temperature fluctuations by the method devised by Siedentopf (and described in chapter II), a second 24 m high mast had been erected on the secondary summit of La Silla in addition to one on the highest top which had been erected in 1966. Supervision of the construction work had been taken over from the retiring engineer H.O. Voigt by his successor Raul Villena per August 1, 1967.

Astronomical activity with the 1-m telescope in its provisional dome had been well under way throughout the year. In Santiago, concrete foundations for the Headquarters and the connected mechanical workshop were partly finished.

In the course of the next year, 1968, almost all elements on La Silla assumed their intended functions. The 1-m telescope was transferred from the provisional dome to its definitive one in September, the 1.5-m telescope was installed in its dome in the middle of the year, the GPO was put into operation in June, and an aluminizing plant was installed in the building of the 1.5-m telescope [3]. The Bochum 60-cm telescope was installed in September. Preparations were made for the erection of the building for a

second “national instrument”, the 50-cm Danish photometric telescope (see below). The Hostel was finished and became available for those, staff and visitors, who during those early years had had to be satisfied with the provisional huts, dining rooms, etc. – these had been primitive, yet not unattractive for the pioneering-minded.

A very important improvement of the operations was the conclusion of a contract with the Chilean national communication system ENTEL by which La Silla was incorporated in the national telephone system in exchange for ESO allowing ENTEL to place one of its relay stations on La Silla [3]. From that moment on, the Observatory felt considerably better integrated with the rest of the world.

In 1968 also the road on the summit area was extended to the top where ultimately the 3.6-m telescope was to be placed. Moreover, in order to create sufficient space on this site, the top was lowered by about 9 metres [3]. This enlargement of the area was found necessary because a geological fault across the site had been detected, limiting the space of the telescope foundations to either the one or the other of the two approximately equal parts.

### **The Santiago Headquarters**

Meanwhile, an important development had taken place in Santiago: the creation of the ESO Headquarters building. The ESO Convention contains no mentioning of a Centre or Headquarters in the country where the Observatory is established, nor is there reference to it in the Convenio, the agreement between ESO and the Chilean Government. Yet, from the beginning of its activities in Chile, ESO planned it, in Santiago, besides the main facilities on La Silla and the Office in La Serena. Before we follow the realization of this project, it is useful to have a brief look at the philosophy behind it, the more so because the role of the Santiago establishment was drastically reduced in the second half of the 1970's.

### **MAY 1967, CONSTRUCTIONS ON LA SILLA**

**Top photograph:** *The building for the 1.5-m Spectrographic Telescope taking shape. In the foreground, left, part of the provisional dome for the 1-m Photometric Telescope.*

**Bottom photograph:** *Construction of the Hostel.*  
*Both photographs from slides by the author.*



Already during the site testing in South Africa, the question of the infrastructure of the Observatory was occasionally taken up by the ESO Committee, although not to the point where basic decisions were to be taken, for the switch to South America became more and more a reality. Nevertheless, it was the consensus of opinion that ESO would have to create, besides its Observatory in the Karroo desert, a centre in or near the city of Capetown at a distance of some 300 km. Such a centre would serve for entertaining contacts with Government authorities, for transport services, and almost certainly also as a base with offices for administration and staff scientists and with technical laboratories from where much of the operation of the Observatory would have been conducted. A serious drawback for the operations on the sites tested, particularly of the one at Zeekoegat, would have been the remoteness from centres with sufficient educational and cultural facilities to make employment attractive for staff members with families coming over from Europe. Capetown seemed the natural candidate for such a centre. Thus, in the report on their visit to South Africa in August–September 1962, Fehrenbach and Heckmann wrote: “— — — *Nous sommes convaincus que l'établissement de l'Institut à Capetown est non seulement parfaitement possible, mais très indiqué — — —. Les possibilités de la ville de Capetown sont considérables. — — —*” [4].

Transferring this structural aspect from South Africa to Chile, the choice was less obvious. The capital Santiago is at a distance from the Observatory about twice what Capetown would have been. With La Serena much nearer, it was clear that here the base for the building activities had to be established. But should it also serve as a base for the scientific and technical staff, and hence become the staff's residential area?

At this point let me briefly refer to a somewhat connected aspect of ESO's role in European astronomy about which opinions were not always unanimous: should ESO become a scientific institute in its own right – or should it

#### LA SILLA, DECEMBER 1967

**Top photograph:** Buildings and domes for the Spectrographic Telescope (left) and the Photometric Telescope (middle) nearly completed, as seen from a site near the GPO.

**Bottom photograph:** La Silla's earliest Residential Quarters, Office Buildings, Catering Facilities for night- and day workers, etc., located on the western mountain slope, beneath the water tanks and near the Schmidt Telescope building. Both photographs from slides by the author.

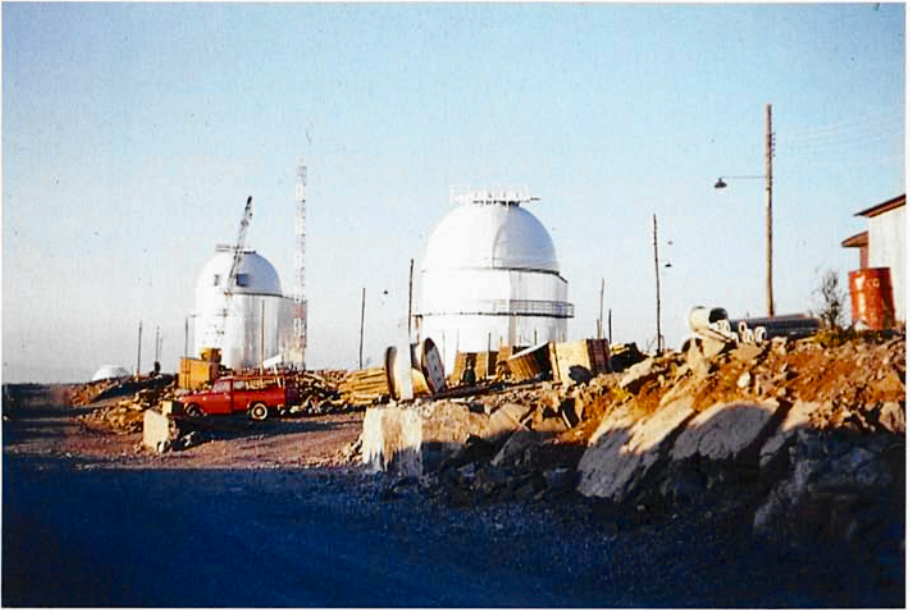

rather be what our French colleagues used to call an "*Observatoire de mission*"? By this we mean, a facility of which the function is basically to serve astronomers from the participating institutes to collect observational data which they then carry home for further analysis. The Convention is not explicit on this point; in its preamble it speaks of "*creating an observatory equipped with powerful instruments – – – and accordingly promoting and organizing co-operation in astronomical research*". Co-operation only in running the facilities – or also in the joint effort in the study of the heavens? The same uncertainty is encountered in the initial historical statement of 26 January 1954 reproduced in chapter I.

I shall come back to this recurrent matter of policy in chapter XI. In the present context we note that in the 1963 stage of planning a Centre called Headquarters was foreseen in Chile including among other items: a large lecture room, many offices for astronomical staff besides those for visiting astronomers, a rather complete library, photographic services, etc., clearly suggesting a research centre of considerable scope. (See, again, Ramberg's article in *ESO Bulletin* No. 2 referred to before.) But, where to build this Centre? At the July 1963 meeting of the ESO Committee, in the context of the report on the visit of some Committee members to Chile (the "Summit meeting" described in chapter III), its Chairman is quoted mentioning that "*– – – AURA is setting up its Headquarters in La Serena. In this little town few English speaking people are living; yet it has a small English school. Santiago offers better possibilities for cultural life; it has two good French schools, two German, one English, and one Swiss school. – – –*"

The matter was discussed again on January 20, 1964, on the occasion of an informal preparatory meeting of the ESO Committee (preceding the meeting with representatives of AURA and CARSO mentioned in chapter III). The Directorate referred to the better contacts with Government authorities, embassies and representatives of international firms in Santiago, and to the advantage of the presence of universities and European schools. On the other hand, the importance of La Serena as a centre for the co-ordination of constructions was obvious and there was the important fact that AURA established here its Headquarters. According to the minutes "*The discussion converges towards the opinion that the ESO Headquarters should be located in Santiago and an ESO supply office should be erected at La Serena. – – –*" [5]. A decision was postponed until more experience would have been collected in Chile. Yet, the decision in favour of Santiago was taken already at the second Council meeting, in May 1964. The minutes report that, after discussion of the various arguments mentioned before, and in particular upon the expression of preference for Santiago by the previously hesitant French delegation, the decision was taken unanimously.



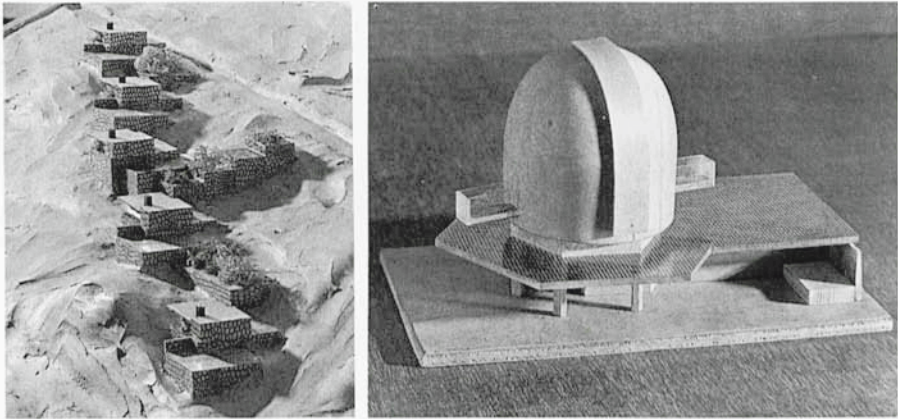

### **FANCY DESIGNS, NOT REALIZED**

*First sketches for the buildings on La Silla by the architects de Vlaming & Salm included some quite fancy ones for living quarters and telescope buildings like those reproduced here. However, they did not quite meet observational and budgetary requirements.*

*From photographs in the EHPA.*

## **The Vitacura Donation**

Meanwhile, for the Council meeting of May 1964 the Directorate had prepared a presentation of various offers for land in the Santiago area [6]. However, shortly after this, in August 1964 the Chilean Ministry of Foreign Affairs generously suggested that ESO might receive as a donation state-owned grounds in Santiago. These grounds were adjacent to the United Nations building in the Vitacura district, an attractive and prestigious location. By letter of September 18, 1964 the Chairman of the Finance Committee authorized the Director to react positively, and after study of the proposition from architectural and technical points of view and an extensive series of internal Chilean legal steps [7], the contract between the Chilean Government and ESO was signed on October 30, 1964 [8].

The donation concerned an area of about 3.4 ha. Conditions from Chilean side were only that no residential buildings should be included, and that realization should start within one year after the signing of the contract. For purposes of architectural harmonization, consultation took place between ESO's architect de Vlaming and the architect (Duhart, a pupil of Corbusier)

of the adjacent UN building – one of quite unorthodox design. By the time of the dedication of the road on La Silla, March 1966, the architectural designs had been completed [9]. Construction began early 1967, and at the time of the 1969 dedications the building was just ready to receive ESO's guests and start its function in science and administration. It was of simple, yet distinguished style, fitting the representative aspect of its future intended role.

### **The National Telescopes**

Returning now to La Silla, we must first report on an originally unforeseen element.

The intermediate-size telescopes described in chapter IV and erected on La Silla in the second half of the 1960's, as well as the Schmidt and the 3.6-m telescope that would follow later, all belonged to the Initial Programme defined in the ESO Convention. The term "Initial" indicates that beyond these, at some stage in its development, ESO might wish to add other instruments. What one had in mind were instruments of different properties but having the same status as the earliest ones. A small addition of this kind was realized in the year 1971: the 50-cm photoelectric telescope, not only because of the need for such observational data but also because it was to serve for trying out automation designs in the development of the large Telescope [10]. It was a duplicate of the Copenhagen 50-cm national telescope put on La Silla in 1969 as described below, and it became part of the regular budget.

However, an extension of the telescope park not foreseen in the early days constituted the so-called national telescopes. They may be defined briefly as telescopes which are the property of one of the member states or, even narrower, of an institute in one of these states and placed on La Silla, making use of La Silla's favourable climatic conditions and logistic facilities, and for which, as a compensation for ESO's services, ESO then obtains a certain fraction of the observing time. In practice, ESO as a rule has provided the building for the telescope, with or without the dome. In the course of time these telescopes have become an important and, from the point of view of the community of observers, virtually integral part of the ESO facilities. In the following I shall briefly review their early history: by the time of the dedications in 1969 the first proposals of this kind had already been realized.

### **The First National Telescope: the Bochum 60-cm**

The first proposal for such a telescope was an initiative of the Director of Bochum Observatory, Th. Schmidt-Kaler, discussed by Council in its meeting of November 1966 following pre-discussion in the FC. The telescope, meant for photoelectric work, was to be acquired with financial support from



### SEPTEMBER 1968, MOVING THE 1-m TELESCOPE

*In September 1968 the 1-m telescope could be moved to its permanent dome. Dismantling it and taking it out of the provisional dome required taking the latter apart, for the slit was too narrow to let telescope and base through.*

**Left-hand photograph:** *The telescope tube hangs on the crane, in the foreground left the provisional building and in the right foreground the dome. In the background the building of the Bochum Telescope.*

**Right-hand photograph:** *Telescope tube and base on their way to the new dome.*

*Photographs by Eric Maurice in the ESO Historical Photographs Archives.*

the Deutsche Forschungsgemeinschaft (DFG), the national science foundation of the German Federal Republic. Accordingly, partners in the negotiations were ESO, the DFG and Bochum University. In his presentation of the proposition to Council, Heckmann placed it from the outset in the context of possibly having more such additions to the ESO facilities. The Bochum proposal was in principle approved at the same Council meeting, but the contract between the three parties in its final form signed only in 1969 after

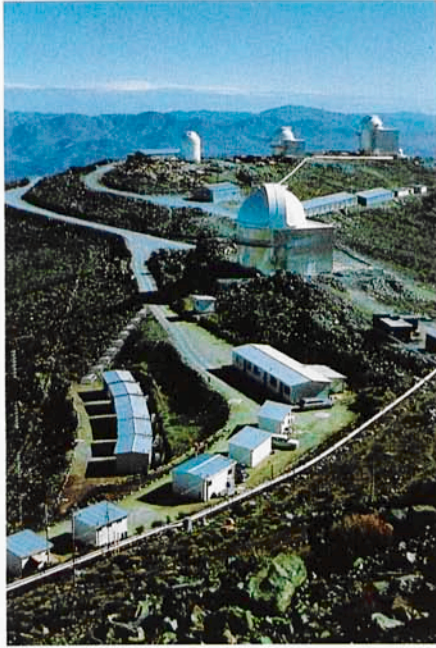

#### OVERVIEWS OF LA SILLA, 1968

**Left photograph, June 1968:** Taken from near the water tanks, from foreground to background: the provisional Residential Area, the Schmidt telescope building, and, from left to right, buildings of the GPO, the 1-m, and the 1.5-m telescopes.

**Right photograph, October 1968:** Aerial photograph taken from the North-East. From left to right: the buildings of the 1-m, the 1.5-m, the provisional 1-m, and the Bochum telescopes, and the Hostel. In the foreground before the Hostel, site preparation for dormitories. This photograph may be compared to the one taken from the same position in October 1966, shown on page 97.

Both photographs by Eric Maurice in the ESO Historical Photographs Archives.

successive approximations [11]. Principal conditions of the contract were that ESO would be granted 30% of the observing time, that apart from the telescope, the DFG also paid for the dome, and that neither of the parties would terminate the agreement within 20 years.

Meanwhile, the building for the Bochum telescope was completed in 1967, and equipped in April 1968 with a prefabricated dome as had also been done for the preliminary housing of the 1-m telescope. Contrary to what was done

for later national telescopes, the Bochum building included dormitory facilities for the observers. The telescope was installed in September 1968. A description, including the Bochum photometer, has been given by Th. Schmidt-Kaler and J. Dachs in *ESO Bulletin* Nr. 5 of December 1968.

Already on the occasion of this first Council discussion, in November 1966, there was reference to two other potential proposals. A. Reiz, attending the meeting as “observer” on behalf of Denmark that would join ESO in August 1967, expressed the hope that a national 1.5-m Danish telescope, still in the planning stage, might be put on La Silla, and there was also reference to a (distant) possibility that Uppsala Observatory might move the Schmidt telescope it had in 1957 installed at Canberra, Australia, to La Silla – a proposition that was never realized. We shall return later to the Danish 1.5-m telescope.

### **The Danish 50-cm Telescope**

The second national instrument installed was the 50-cm photoelectric telescope belonging to Copenhagen Observatory. Early consultations with the Director of ESO led to a proposal for the Council meeting of December 1967, just after Denmark’s joining ESO. At that time, the telescope was meant to be temporarily only on La Silla, for a specific programme, and it therefore was first, in February 1969, installed in the provisional building of the 1-m telescope after the latter had been moved into its proper dome. However, already in the course of 1968 Council agreed in principle to install the telescope on a more permanent basis, which led to first draft contracts between ESO and its owner of 1968 [12]. The agreement in its final form between Copenhagen University and ESO was signed only in 1975, simultaneously with that for the Danish 1.5-m telescope [13]. For the housing of the telescope a new dome was built, identical to the one for the ESO 50-cm instrument. These buildings were finished in 1971 and in it the telescope became operational again in the same year.

### **The Danish National 1.5-m Telescope; Basic Considerations**

It would take many years until the next national telescope would be installed: the Danish 1.5-m. (A 40-cm telescope with its housing and adjacent office space was installed in 1975 by the Geneva Observatory; however, as Switzerland was not yet a member state of ESO at that time, its status was different from that of the telescopes discussed here.) The Danish 1.5-m was the subject of an application by Reiz and Strömgren of 9 November 1968 [14] which was accepted in principle by Council in its meeting of June 1969. However, the telescope became operational only a decade later, in October 1979, an epoch well beyond the period covered by this book. Council’s

VI. FURTHER DEVELOPMENTS IN CHILE



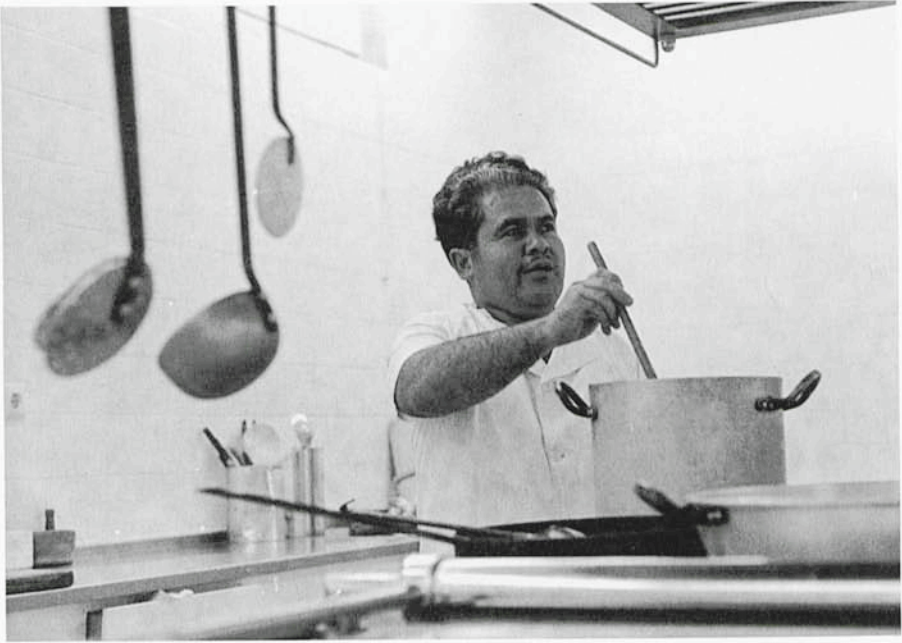

*January 1969 on La Silla. ESO's cook Pedro ("Chico") Pasten enjoying the new kitchen facilities in the Hostel.*

*From photograph in EHPA.*

#### **MEALS IN OLD AND NEW AMBIENCE**

**Top photograph:** May 1967, Kapteyn Laboratory observers M. de Vries and R. Mulder, with ESO's mechanic J. Doornebal, relishing a meal in the provisional restaurant.

*Photograph from a slide by the author.*

**Bottom photograph:** January 1969; Tea-time in the new cafeteria. At the foreground table from left to right: Albert Bosker, anonymous, J. Palisson, Hans-Emil Schuster and A. Siméon.

*From the ESO Historical Photographs Archives, in collection marked "January 1969 von Dr. Muller".*



**March 21, 1969; Reception at ESO Headquarters.** From left to right: G. Sahade, Mrs. J. Heckmann, O. Heckmann and J. H. Bannier.

*Photograph in EHPA.*

approval in 1969 must be seen in the context of far reaching proposals for extensions of the telescope facilities submitted in the year 1968 by the Scientific Programmes Committee, a committee installed in December 1967 and to the activities of which I shall return in the next chapter.

It was this Danish telescope that in an early stage evoked more thorough discussion of national telescopes in general than Council had devoted to them in the beginning. This started at the December 1968 meeting and continued at the meetings of March, June and December 1969. In these discussions the French delegation, whereas it fully supported the acquisition of the Danish telescope, stressed the importance of formal aspects such as the question whether these telescopes would fit within the ESO Convention and the



Convenio with Chile, it warned for overcrowding on La Silla, and insisted on careful selection of such telescopes and certain scrutiny of their observing programmes, and study of the financial implications. The first French remarks were added as an addendum (by P. Lacroute) to the minutes of the December 1968 Council meeting [15].

Further discussion was based on two documents: “Instruments étrangers implantés à La Silla; Essai d’évaluation de la valeur de la contribution de l’ESO” [16] prepared by the French delegation, and one by the ESO Directorate: “General Conditions for Admission of National Telescopes on La Silla” [17]. The laborious discussions, at which the French delegation took the view that national telescopes should be considered in the category of Supplementary Programmes as defined in the Convention (see chapter I) – did not lead to a clearcut policy for future applications. It had fallen into the background by the time when, years later, the matter of national telescopes became of interest again. However, the discussions were symptomatic for growing concern among Council with regard to developments in ESO. In the next article we will return to these worries. For the moment we will forget about them, just as Council did – superficially at least – when it proceeded to Chile for the festive dedications . . .

## **The Dedications**

On their way to Chile, Council on March 17, 1969 paid a visit to AURA’s Kitt Peak National Observatory near Tucson, Arizona. Confrontation with this observatory, of comparable size to what ESO intended to become, naturally should be instructive, and was prompted by a history of mutual collaborative attitude and AURA’s counsel in ESO’s instrumental developments. AURA’s President W.A. Hiltner and Kitt Peak Director N.U. Mayall were, in turn, guests at the ESO ceremonies in Chile.

Council arrived in Santiago on March 19 and acquainted itself that same day with the Headquarters in Vitacura. The next day it visited the Guesthouse, enjoyed the swimming pool and a reception by the German Minister of Education Dr. G. Stoltenberg, and on March 21 visited Cerro Calan Observatory and its Director Claudio Anquita followed by a general reception at ESO Headquarters. On March 22 a full-day Council meeting took place there. On March 23 Council flew to La Serena and visited this town and its surroundings, and on March 24 it went by bus to Pelicano and next to La Silla. Council members stayed in the Hostel and visited the many installations in operation: telescopes, workshops, powerplant, storerooms, dormitories, etc. On March 25 the inauguration ceremonies described in the beginning of this chapter took place. On March 26, Council paid a visit to Cerro Tololo Interamerican Observatory, and after having spent the night in La Serena, they flew back to Santiago on March 27 [18].



Following the dedication ceremonies in March 1969, the German Minister of Education, Dr. Gerhard Stoltenberg, visited the ESO Guesthouse where he made acquaintance with members of the ESO staff and their wives. In these two photographs Director General O. Heckmann introduces to Dr. Stoltenberg from left to right: Mrs. Ursula Villena, Raul Villena, Harold Hyslop; Mrs. Louise Muller and Mrs. Olga Hyslop.

*From a series of photographs in the ESO Historical Photographs Archives.*

### THE HEADQUARTERS IN THE VITACURA SUBURB OF SANTIAGO

**Top photograph:** December 1968, view of HQ from the roof of the adjacent United Nations building: main building of HQ is to the left of the middle of the photograph. Photograph by Eric Maurice in ESO Historical Photographs Archives.

**Bottom photograph:** December 1967, the construction stage visited by Victor Blanco (left) and Jürgen Stock (middle) of AURA-Cerro-Tololo, with Raul Villena of ESO. Photograph from slide by the author.

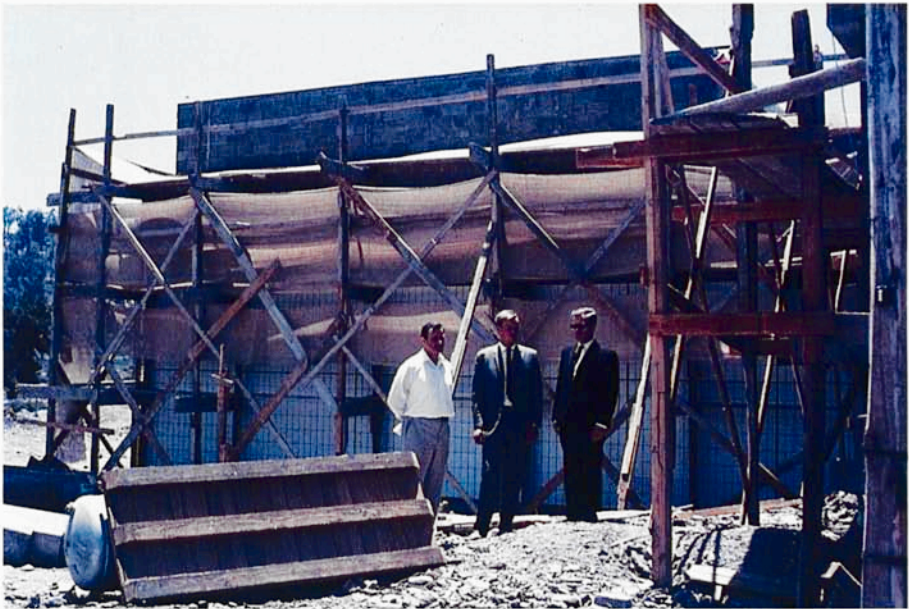
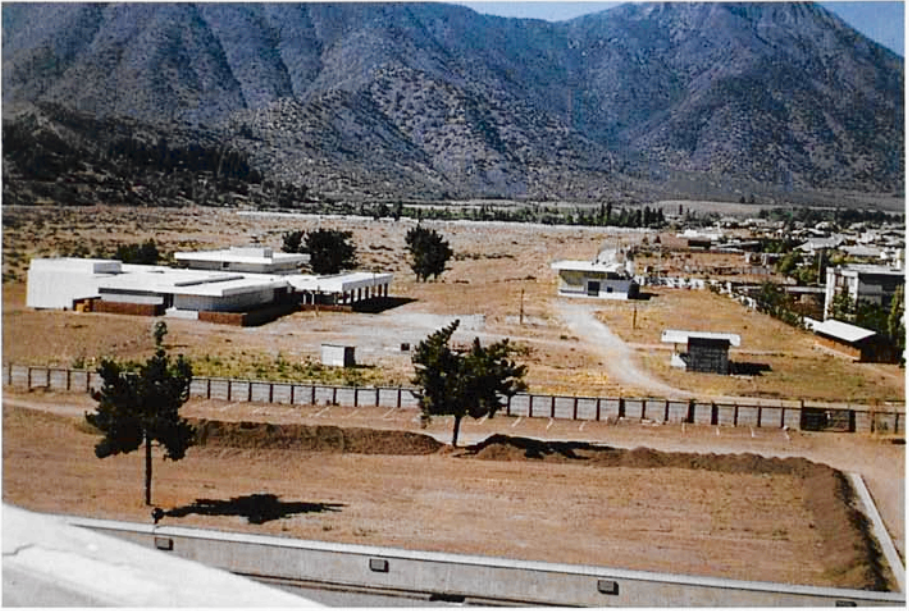

### **The Dedication Symposium on the Magellanic Clouds**

The dedications also induced ESO to organize its first broad scientific symposium at the Headquarters in Santiago on March 28 and 29. Subject were the Magellanic Clouds, one of those objects of research at which ESO had aimed from its very beginnings. Participants came from Argentina, Australia, Chile, Mexico, South Africa, the United States and, naturally, from the ESO member states. The Proceedings of the symposium, edited by André Muller, were published in 1971 [19]. The symposium underlined ESO's taking up its tasks in astronomical research – although at that time modest observing programmes had been underway with the first telescopes, as we shall see in the next article. An early report on the subjects discussed at the symposium was given by Bengt Westerlund in *Sky and Telescope* of July 1969 (Vol. 38 No. 1).

## VII. THE LATE 1960's: Structural Changes, First Scientific Activities and Some Soul-Searching; the Journal A & A

*“La construction et l'installation du grand télescope – – – sont l'objet de sérieuses préoccupations de la part de la délégation – – –”.*

From a letter of the French Council delegates to the President of Council, June 15, 1969.

### Introduction

The late 1960's were years of transition. With the dedication of La Silla in March 1969, ESO's first phase of constructions had been concluded. Realization of the Schmidt and the 3.6-m telescopes would be the main goals for the next years, besides the Observatory's taking up its functions as a research institute. The transition was accompanied by a change in the structure of the management of the Organization and by the creation of a Scientific Programmes Committee. While the latter, as one of its assignments, reflected on, and suggested, directives for ESO's long-range development beyond the Initial Programme of the Convention, the Organization also underwent some thorough – and sobering – soul-searching. These developments, together with a brief account on the first scientific activities and the role ESO played in the creation of the journal *Astronomy and Astrophysics* will be dealt with in the present chapter.

### Changes in the Directorate

At the November 1966 Council meeting, Otto Heckmann reminded Council members that it was the present management's task “– – – to construct the Observatory, not to work scientifically – – –”, and that his appointment as Director per November 1, 1962 had been for a term of five years, thus ending per November 1967; a decision would soon have to be taken on his future role. The Council meeting of June 1967 ensured Heckmann's continued supervision of construction activities by extending his appointment till the end of 1969, and responsibility for the development of scientific activity was assigned to myself in part-time association with the ESO Directorate. These moves were formalized by Council decisions of December 1967 at which also Ramberg's position was redefined: Heckmann became Director General

until December 31, 1969; Ramberg Technical Director per January 1, 1968; and Blaauw Scientific Director on 50% time basis per February 1, 1968.

The new set-up functioned till Heckmann's retirement as Director General at which moment he was succeeded by the author. Ramberg continued as Technical Director (he would retire per December 31, 1971). The post of Scientific Director was suppressed per January 1, 1970. Heckmann continued for a limited period as consultant in connection with the work on the Schmidt and 3.6-m telescopes. Some other major appointments made about this time, connected with instrumental developments and administrative affairs will be mentioned later.

Meanwhile, Bengt E. Westerlund had per June 1, 1969 taken up the position of Director for Chile (based on Council's decision of June 1968) after having been associated with Steward Observatory in Tucson, Arizona, bringing to ESO his thorough acquaintance with the Southern Sky gathered during earlier association with Mount Stromlo Observatory in Australia. André Muller, after almost six years of building up ESO in Chile, returned to Europe where he joined the Office of the Director in Bergedorf per October 15, 1969 for the new task of organizing the rapidly growing Visiting Astronomers Programme. As we have seen in chapter IV, observational activity on La Silla had started at the end of 1966 with the 1-m telescope. It now grew rapidly.

### **Earliest Scientific Activities and the Creation of the SPC**

About one year after the ratification of the ESO Convention, in its December 1964 meeting, Council appointed a small advisory committee for preparing a discussion on the way the Observatory should operate: on the size and role of permanent and semi-permanent staff, that of visiting astronomers, the allocation of observing time, etc. The group, consisting of A. Blaauw (Chairman), E. Geyer, A. van Hoof, P. Lacroute and B. Lindblad, met at Bergedorf on May 6, 1965 and submitted to Council a document "Considerations and Recommendations Concerning the Exploitation of the Observatory" [1]. As it reflected what at that time was expected from ESO, let me mention some of its contents.

It started by saying that "*Whereas the role of the observatory as an astronomical institute in its own right --- should be of great importance, the facilities of the observatory should particularly be available to serve the national interests of the member states.*" To this end, there should be a staff of permanent and semi-permanent members - to be engaged at the ESO establishments - and the facilities should be frequently used by visiting astronomers from the ESO countries. Besides the research by individual staff members and visiting astronomers, the observatory might conduct "*general programmes --- to provide documents of fundamental significance but not*



*By way of introduction to our description of the early observational activities on La Silla, we show the Observatory under the southern sky, as seen by the Chilean artist Nemesio Anthunesz. The painting was made at the request of the Swedish Natural Science Research Council – ESO being one of the many projects this Council supports – and it decorates this Council’s Wenner-Gren Centre Headquarters in Stockholm. In 1970, when he made the painting, Anthunesz was Director of the Museo Nacional de Bellas Artes in Santiago.*

*In the artist’s impression we recognize the general layout of the Observatory as seen from the south, with the Schmidt-Telescope building in the foreground and the cluster of intermediate-size telescope domes – and even the ENTEL Communications System relay mast – farther down. (Compare the photograph on page 114.) We also recognize, to the left above the Observatory, the conspicuous constellation of the Southern Cross with, starting from its extreme lower right star Alpha Crucis, in clockwise order the stars Beta, Gamma, Delta and Epsilon Crucis. Naturally, as it is located at declination  $-60^\circ$ , in reality the Southern Cross can be seen from La Silla only in southerly direction – but never mind . . .*

*The author is indebted to Dr. M. O. Ottosson, Council member for Sweden, who kindly made the photograph of the painting available for the Messenger.*

*necessarily requiring immediate analysis, such as, for instance, a sky-atlas, astrolabe programmes, systematic observations in Selected Areas, etc."* and these "are the responsibility of the Council who, upon the recommendation of the Scientific Programmes Committee, may charge a staff member or, possibly, another astronomer with the supervision of such a programme."

"Semi-permanent staff members --- normally employed for about 3 years in Chile --- should be well acquainted with the instruments and are to be charged with the instruction of the visiting astronomers in order to ensure efficient use of the observatory's facilities. --- they [also] may be charged with the responsibility for the execution of the "general programmes". --- At any time, there should be present in Chile and at the disposal of the Director, for each major ESO telescope a permanent or a semi-permanent staff member well acquainted with that telescope." With regard to semi-permanent staff the document stated that "in order that ESO may attract qualified astronomers --- it is necessary that they possess the guarantee of continuation of their positions in the home countries upon their return from Chile --- continuation of pension rights and --- social security benefits. It is of great importance that the respective governments of the member states adopt a cooperative attitude towards this problem."

Visiting astronomers were supposed to stay in Chile for periods of two months to one year. The advisory group also proposed that Council establish two kinds of fellowships: those for young students, and those for distinguished scientists invited to do research at an ESO establishment. For the allocation of observing time the advisory committee suggested that applications by visiting astronomers were to be submitted first to national committees to be created for this purpose, who then would pass on the applications with their advice to a Scientific Programmes Committee - SPC - to be created by the Council. Proposals were added for the constitution and the task description of this SPC.

In several respects, the arrangements suggested were modified in actual practice. Not Council, but the ESO Director would be in charge of the execution of general programmes; short stays of visiting astronomers became the rule rather than the exception; applications were not first scrutinized by national committees; special fellowships for distinguished astronomers would not be in order during the first decade; and guarantee for semi-permanent staff's continuation of their employment in the home country has seldom been granted.

### **The Scientific Programmes Committee (SPC)**

In its meeting of June 1965, Council agreed with the suggestions of the advisory committee, and in December 1965 it appointed a working group (consisting of A. Blaauw, R. Cayrel and O. Heckmann) for making a more





*The last meeting of the Scientific Programmes Committee before it split into the Observing Programmes Committee and the Scientific Policy Committee was held at the Observatory at Roden near Groningen, on November 23, 1971. On this photograph (post-lunch at the restaurant), from left to right: Joke Westra (secretary of the Observatory), Eric Holmberg, André Muller, Martien de Vries (Roden Obs.), Bengt Westerlund, Paul Ledoux, Bengt Strömgren, the author, and Jan Borgman.*

*From ESO Historical Photographs Archives.*

definite proposal for the task and constitution of the proposed Scientific Programmes Committee. The low priority which these matters still had at that time is reflected by the fact that only in October 1966 the group formulated its advice [2] for submission to the December 1966 Council meeting. This led to some revisions of June 1967 [3], following the Council meeting earlier that month. At that meeting, Council decided to establish a Scientific Programmes Committee, to be selected and appointed at the next Council meeting. Meanwhile, the advisory group dealt with the allocations for the 1-m telescope. The December 1967 Council meeting then appointed the SPC with B. Strömgren (Denmark) as Chairman, and the members J. Delhaye (France), E. Holmberg (Sweden), P. Swings (Belgium), G. Traving (Germany), and Th. Walraven (Netherlands), and myself as secretary.

The appointment of Strömgren as Chairman deserves some comment. So far, his name did not occur in these accounts except for his presence at the

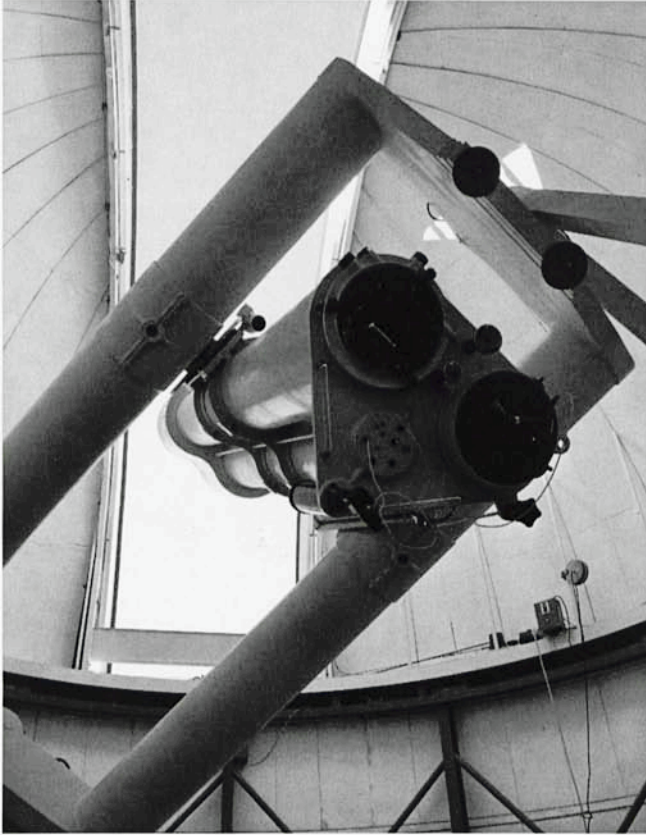

***The Grand Prism Objectif (GPO)***

*After having served in South Africa in the context of site testing, the GPO was installed on La Silla where it resumed its work in the middle of 1968. The optical principle according to which the instrument operates has been described in chapter IV. The photograph shows the twin tubes of which the instrument consists: the left one carrying in front the specially designed objective prism, the right one serving for precise guiding during observing. Once installed at La Silla the GPO continued its work on the Magellanic Clouds, but now under much better atmospheric conditions than in South Africa.*

*From ESO Historical Photographs Archives.*

1953 Groningen Symposium mentioned in chapter I. Bengt Strömberg, one of the most outstanding astronomers of our era, had left Denmark in 1951 after having been Director of Copenhagen Observatory since 1940, to become Director of Yerkes and McDonald Observatories, and was next, since 1957, connected with the Institute for Advanced Studies at Princeton. He returned to Copenhagen in 1967 [4]. Having always entertained a lively interest in ESO's development, Strömberg now was the obvious choice for the SPC Chairmanship.

The SPC held its first meeting on May 2, 1968 at the Bergedorf Office of the ESO Directorate. A list of the SPC meetings is given in Annex 6. (It split by Council decision of June 1971 into the Observing Programmes Committee and the Scientific Policy Committee). Already at these first meetings, in 1968, important items of scientific policy were taken up apart from the evaluation of applications for observing time. However, before considering these, let me first review the scientific activities so far.

A variety of programmes had been conducted with the 1-m Photometric Telescope since its installation late 1966. Measures of the photometric extinction on La Silla were, of course, a first requirement. A major project was the photometry of stars in the Magellanic Clouds identified by means of the GPO during its operation in South Africa; this was done by J. P. Brunet of Marseilles Observatory. Observers from the Kapteyn Laboratory at Groningen studied in 1967 early-type stars in southern clusters and associations and carried out a test programme for a new infrared photometer, and guest observers J. Stock and E. Mendoza also used the telescope [5]. Observations were interrupted for a short period in the fall of 1968 when the telescope was moved from the provisional to its permanent dome.

The range of programmes broadened considerably in 1968 as is apparent from the lists of users given in the ESO Annual Report for that year. Apart from the continuing photometry of Magellanic Cloud stars by the Marseilles group, the majority of the observations were devoted to objects in the Galaxy. With the 1.5-m Spectrographic Telescope, in operation since the middle of 1968, after photographic tests with a provisional plateholder, work first concentrated on spectroscopy with the Chilikass Cassegrain spectrograph in which again work on the Magellanic Clouds dominated; it was performed by Dossin, Maurice and Prévot. Fr. Dossin, from Liège, had been associated with the Office of the Director in Bergedorf since February 1, 1966, but from February 1968 joined the staff in Chile. E. Maurice, of Marseilles, became a staff member in Chile from May 1968, after having been employed by ESO in Marseilles from January 1968 for work on the RV Cass spectrograph. L. Prévot of Marseilles Observatory had been engaged in the GPO programme in South Africa, as described in chapter II. In 1969 Cassegrain and Coudé spectrographic work was carried out in alternation. As reported earlier, the 61-cm Bochum and the 50-cm Danish telescopes came in

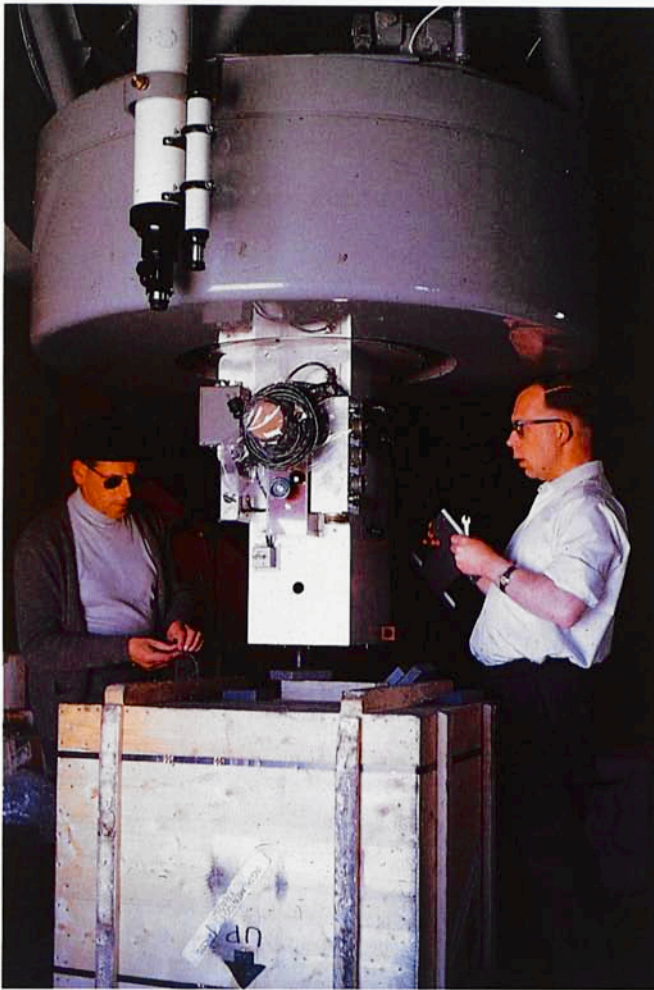

**May 1967.** The ESO photometer for the 1-m telescope, built at Roden Observatory, is mounted at this telescope by André Muller, left, and Martien de Vries of Roden Observatory. The 1-m telescope, the first one in regular operation on La Silla, at that time was still housed in its provisional dome and had previously been used with a simpler, borrowed photometer.

*Photograph from a slide by the author.*

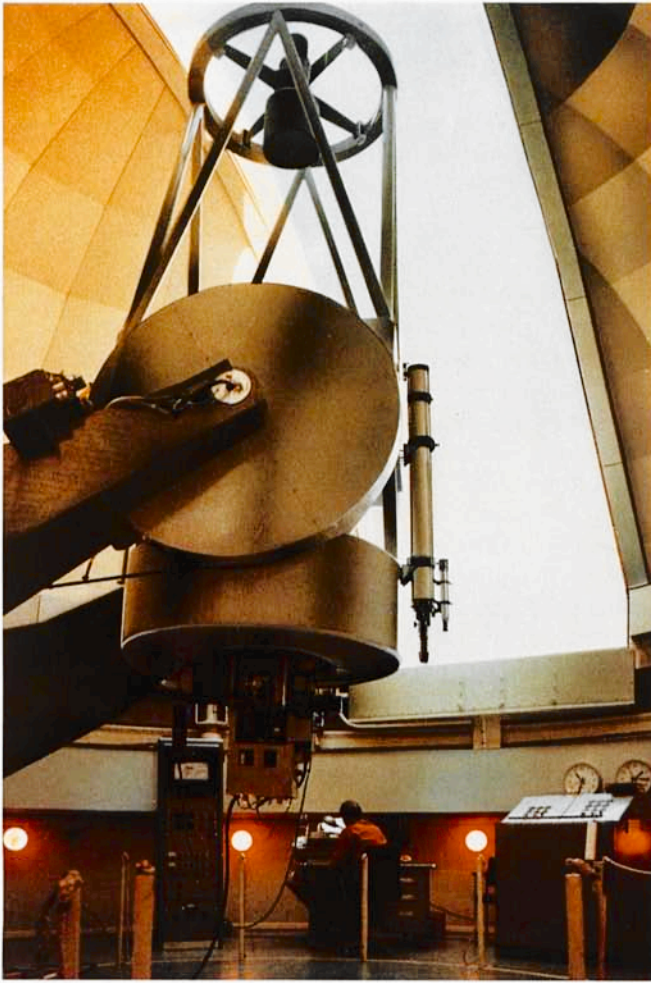

### ***The 1-m Photometric Telescope***

*After having been housed in a provisional dome on La Silla since the end of 1966, the telescope resumed its work in the permanent dome in the fall of 1968. It is shown here after the move, equipped with the ESO Photometer and with Jan Doornenbal, ESO's Chief mechanic in the background. During the first years, the telescope was mainly used for the study of stars in the Magellanic Clouds detected by means of the GPO, and individual stars, star clusters and stellar associations in our Galaxy.*

*From ESO Historical Photographs Archives.*

regular operation in the course of 1969; for their programmes I refer to the lists in the ESO Annual Reports.

By the end of 1969, the astronomical staff in Chile consisted of the members mentioned already: Westerlund, Dossin, Schuster and Maurice, to whom had been added in the course of 1969 A. Ardeberg of Lund, from May 15, 1969, and J.J. Rickard, formerly of the California Institute of Technology, from October 1, 1969.

### **The First Coopérants**

An interesting addition to the staff in Chile were French "coopérants". By agreement with the French Ministry of Foreign Affairs, in the context of French service to underdeveloped countries (specifically for Chile), young Frenchmen, preferably astronomy students, were allowed to substitute their military service for work on La Silla. For this service they were proposed by ESO to the Ministry, upon recommendation by the French National Committee for Astronomy. The first ones to enjoy this duty were Jacques Colin from Besançon Observatory who arrived in Chile early in 1970, and Jacques Breysacher from Nice Observatory, who followed in the fall [6]. From then on, each year French coopérants were stationed in Chile. Belgian coopérants soon joined them under a similar arrangement, but the other ESO member states could not be persuaded to interpret military service that scientifically.

### **The Roden Colloquium on Photometry of February 1966 and the Nice Colloquium on Spectroscopy of June 1969**

The early photometric activities with the 1-m telescope had been inspired to some degree by ESO's first scientific colloquium, held under the title "ESO Colloquium on Photometry" at the Kapteyn Observatory at Roden from 9 to 11 February 1966. About 70 astronomers from the member states and some specialists from other countries attended, and reviewed the field of photoelectric photometry. An extensive report on the Colloquium was published by Borgman in *ESO Bulletin* No. 1 of November 1966 (which also gave two useful tables with the optical properties of the first ESO telescopes and spectrographs). For those who attended it is of interest to recall the quite unusual weather conditions prevailing at the start of the Colloquium: a sudden, heavy glazed frost causing breakdown of power lines and telephone connections, and thus for a while isolation of Roden Observatory and unheated lodging for some of the participants . . .

A spectroscopic counterpart to the Roden Colloquium was the ESO Colloquium on Spectroscopy, held at Nice Observatory on June 3-5, 1969. We are not aware of a comprehensive report; contributions were published separately, for instance one by A.B. Underhill on Early-Type Stars in *ESO Bulletin* No. 8, June 1971.



**SILENCIO, ASTRONOMOS DURMIENDO.** Near the sleeping quarters of the astronomers, March 1969.

*Photograph in EHPA.*

### **The Allocation of Observing Time**

For allocating the observing time for 1968, the ESO Directorate called a meeting of the applicants, in its office, on November 23, 1967 [7]. Invitees were A. Ardeberg (Lund), A. Behr (Göttingen), M. de Vries (Roden), E. Geyer (Bonn) and U. Haug (Tübingen). The meeting acquainted the Directorate with the research interests in the member states, and made the applicants mutually acquainted with their projects. Such presentation of research proposals in the circle of fellow applicants was soon abandoned, however, when their number increased.

The SPC took over in the course of 1968. In July 1968 Council adopted rules for the allocation in accordance with a proposal of the SPC [8], the main elements of which were:

- Allocation was to be done for periods of 6 months: March–August and September–February; deadline for applications was six months before the

beginning of the allocation period; per proposal the Directorate should request evaluation by at least one member of the SPC; final allocation was to be done by the Directorate at the recommendation of the SPC; for proposals of unusually long duration or heavy financial implication the Directorate should consult with the Chairman of the SPC; applicants were to be informed on the allocations at least four months before the beginning of the allocation period; but for all this, “--- rules to be handled with flexibility ---”.

### **The SPC and the Future: More Telescopes and an ESO Centre?**

From the outset, Council considered the SPC's task as twofold: not only should it advise the Directorate on the allocation of telescope time, it also might suggest long-range research projects and extensions of ESO's observing facilities [9] beyond the “Initial Programme” of the Convention.

In their second meeting, on October 17, 1968, the SPC took up the thread of early Council deliberations of November 1966, in which Council had touched on the broadening of the ESO membership, on extension of its instrumentation, and on the possible creation, somewhere in Europe, of an ESO Centre for the development of measuring instruments and for promoting scientific contacts between astronomers of the member states. Reference was also made to the promotion of Laboratory Astrophysics, a new branch of astrophysics that rapidly gained attention in the mid-1960's [10]. The SPC now formulated more precise proposals and submitted these to Council in letters of the SPC chairman of November 15 and 20, 1968, for discussion in the Council meeting of December 3 and 4 [11]. We review here these proposals and the reactions in Council.

Strömberg's letter of November 20, discussed first by Council in the December 1968 meeting, emphasized that the Headquarters in Santiago should be well equipped with measuring facilities for visiting astronomers and resident staff, especially for the evaluation of photographic plates, but that such equipment should be developed preferably at an ESO Centre in Europe, in collaboration with both institutes in the member states and commercial firms, and this Centre should then also become a place for evaluation of observational data and a scientific meeting ground. As to Laboratory Astrophysics, shouldn't ESO take advantage of, and possibly support financially, capabilities for such work at institutes in the ESO countries?

Strömberg's letter of November 15, 1968, presented proposals for new, powerful telescopes; these had been supported meanwhile by the Instrumentation Committee on November 5 and 6 and concerned:

- a photometric telescope, intermediate in size between the 1-m and 3.6-m telescopes, for instance with an aperture of 2.0–2.5 m.



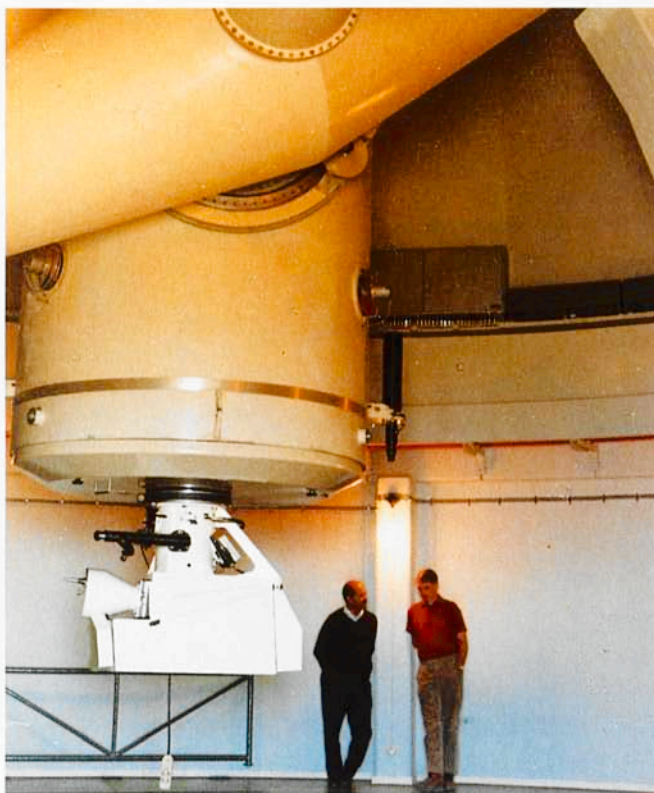

*The 1.52-m Telescope equipped with the Cassegrain "Chilicass" spectrograph, borrowed from Marseilles Observatory. In the background, right, ESO's Chief-mechanic Jan Doornenbal talking to an (yet) unidentified person. In the early years, most of the observing time with the spectrograph was devoted to the determination of radial velocities and spectral types of stars in the Magellanic Clouds that had been detected by means of the GPO observations in South Africa.*

*From ESO Historical Photographs Archives.*

- a Schmidt telescope considerably larger than the ESO Schmidt at that time under construction, for instance one with aperture 2 m and focal length about 6 m.
- an astrometric telescope comparable to the one recently acquired by the US Naval Observatory.

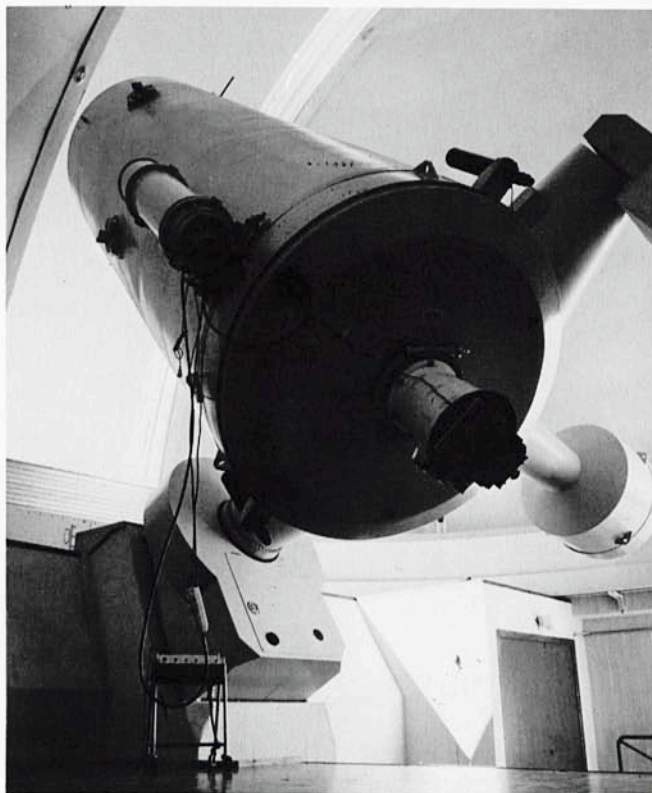

*The 1.52-m Telescope, although designed primarily for spectroscopic observations, was also sometimes used for direct photography, especially in the early stage of optical tests. It is shown here equipped with the Zeiss camera.*

*From ESO Historical Photographs Archives.*

### **The Proposed New Telescopes**

For the photometric telescope the letter mentioned current research problems including: *“Wholesale photometry in the Magellanic Clouds of stars down the main sequence; photometry of faint variable stars like those of the Groningen-Palomar Survey; photometry in various globular clusters and in the directions of the galactic center and central bulge. — — — It would be unfortunate if work on problems of the type mentioned should have to be*

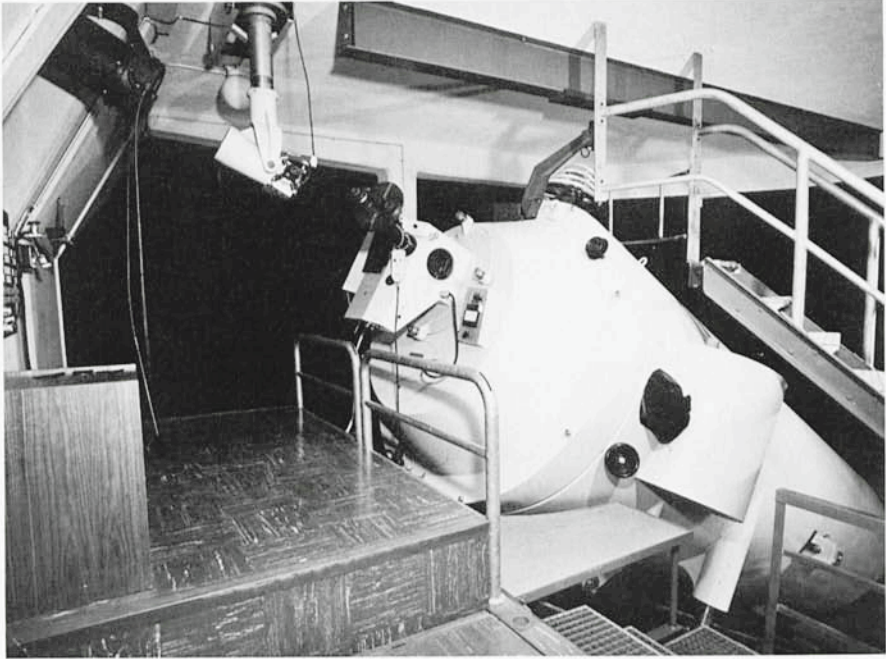

### ***The Coudé Spectrograph***

*For observations requiring high spectroscopic resolution the 1.52-m telescope is used in combination with the Coudé spectrograph of which the upper part is shown in this photograph. It is mounted in fixed position below the observing floor of the telescope; the star light collected by the telescope is directed into the spectrograph by means of a set of mirrors of which the position adjusts itself during the motion of the telescope in such a way that the beam enters the instrument in constant direction. Work with the Coudé spectrograph started in the middle of 1969 and was concerned mainly with the study of interstellar lines and the determination of the abundances of elements in the atmospheres of the stars.*

*From ESO Historical Photographs Archives.*

*postponed until the time when the 3.6-m telescope is available. --- it would certainly be desirable to work on the problems just mentioned with an intermediate-size telescope --- with an aperture of 2-2.5 m --- the SPC favors the Cassegrain type reflector with Ritchey-Chrétien optics, with an effective aperture ratio around 1 : 8. ---"*

With regard to the Big Schmidt Telescope (the name used in Strömberg's letter) it stated: "--- it can be foreseen that the development of image amplification as well as photoelectric spectrum scanning with large numbers of channels, will make it possible to push limiting magnitudes in work with the ESO 3.6-m reflector --- sufficiently far for the ESO 1-m Schmidt Telescope to become inadequate as a companion instrument for survey work. ---" Research problems considered by the SPC included general survey work on faint galaxies demanded by the expected flow of discoveries of radio sources, and many research programmes on galactic structure. "--- what members of the SPC had in mind in considering the possibilities of a big Schmidt Telescope was an aperture of approximately 2 m and a focal length of about 6 m."

The proposed astrometric telescope was to aim at trigonometric parallaxes down to magnitudes 17 or 18, and at proper motions of high accuracy for the study of space motions out to distances of at least 500 parsec.

Highest priority was to be given to the photometric telescope, and to studies for the design of the Big Schmidt.

The above proposals were accompanied by the following cost estimates drawn up by Ramberg.

– Photometric telescope of 2–2.5 m . . . . .	\$ 3,020,000.–
– Big Schmidt telescope of 2 m aperture . . . . .	\$ 6,240,000.–
– Astrometric telescope of 1.5 m aperture . . . . .	\$ 3,200,000.–
all of these including the building and dome.	
The total amounted to . . . . .	\$12,460,000.–

For comparison: the total estimate of the 3.6-m telescope project as it occurs in an estimate of late 1969 compiled by Ramberg (to which we shall refer later) amounted to . . . . . \$ 10,700,000.–.

In the discussions at the December 1968 and later Council meetings, the proposition of an ESO Centre in Europe for development of instrumentation and for the promotion of Laboratory Astrophysics struck a responsive chord because the wish for such a centre had been expressed earlier in Council. We shall later come back to this.

The proposals for additional telescopes were discussed at some length by Council in its meeting of December 1968. Soon after this, however, Council lost interest, for it became more and more clear that the ESO Directorate would have their hands full with the realization of the 3.6-m Telescope. Even worse: concern about this realization soon overshadowed the optimistic views of the SPC about ESO's growth, and ESO was to undergo a short but sobering period of soul-searching. We do note, though, that the project of the Danish 1.5-m national telescope, realized later, would meet to a certain extent the desire for the proposed photometric telescope.

## Soul-Searching in the Late 1960's

In chapter VI, when describing developments around the introduction of the national telescopes, I mentioned the concern, since late 1968, about the lack of progress in the completion of the Schmidt and the Large telescope. Soon signals of discontent on these and some other points grew louder and the Council Meeting of March 1969 in Santiago appointed a Working Group to advise Council, under the Chairmanship of G.W. Funke (former President of the Council), and with the members K.F. Scheidemann (President of the Finance Committee) and A. Alline. Alline had just become the French government delegate on Council and was the one who most strongly voiced feelings of dissatisfaction. The Working Group's task was not strictly defined, but from the Council discussions it was clear that it should scrutinize many aspects of the functioning of the ESO Administration. These were to include: a confrontation of current activities with the aims as defined in the Convention, with special reference to such matters as the national telescopes and the new proposals by the SPC; the financial implications of such extensions; and certain aspects of the functioning of the administrative management.

In a letter of June 15, 1969 to the President of the Council (Bannier), Alline, on behalf of the French delegation, elaborated more specifically, and critically, on these problems [12]: *“--- La construction et l'installation du grand télescope --- sont l'objet de sérieuses préoccupations de la part de la délégation française. --- La délégation demande --- que les provisions budgétaires --- prennent pour objectif d'achever dans les meilleurs délais la réalisation du programme scientifique défini lors de la signature de la Convention [et] d'effectuer des économies sur les chapitres non directement liés à cet objectif ---. L'installation et le fonctionnement d'instruments nationaux --- n'est pas sans poser à cet égard d'importants et délicats problèmes. --- Ni dans son esprit ni dans sa lettre la Convention n'autorise l'introduction de ces instruments ---. La Convention n'interdit cependant pas l'introduction de ces instruments ---. Il peut notamment être fait appel à cette fin à la notion de “programme supplémentaire ---”.*

The Working Group (referring to itself as Working Group for reviewing Programme, Administration Procedures and Staff Problems of the ESO Organization) met on September 11, 1969 at CERN, Geneva [13]. The choice of this location had undoubtedly to do with the fact that Funke and Alline were a member and alternate member, respectively, of the CERN Council. But in a way it also was symbolic: in his comments on the ESO Administration Alline had on several occasions referred to CERN procedures as an example. Invited for the meeting were also, for the ESO Directorate, Heckmann, Ramberg and the Manager Bloemkolk.

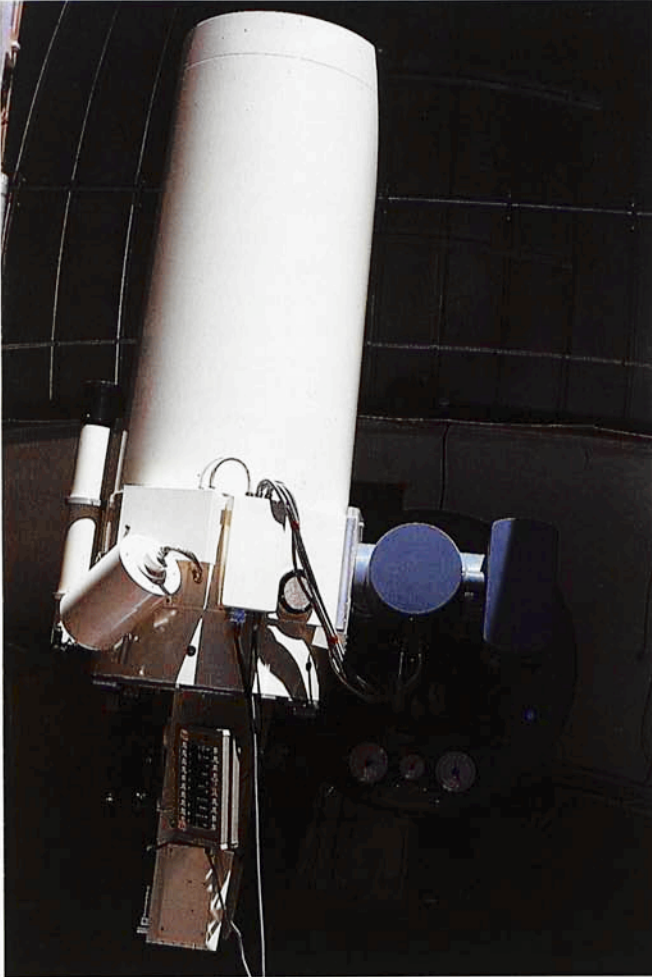

*The 61-cm Bochum Telescope, installed in September 1968, and the first of the "national telescopes" on La Silla. Financed by Bochum University and the Deutsche Forschungsgemeinschaft, it offered Bochum observers the outstanding observing conditions of La Silla whereas, for the logistic facilities offered by ESO, ESO observers received 30% of the observing time. The telescope, manufactured by Boller & Chivens, was equipped with a photo-electric photometer made at the central workshop of Göttingen University.*

*Photograph kindly made available by Bochum Observatory.*



***Despedida in Pelicano.*** Besides its more serious business, Pelicano served eminently for more light-hearted matters. Here, the despedida – fare-well party – for François and Simone Dossin on May 29, 1970. From left to right: Hans-Emil Schuster, the Dossins, Bengt Westerlund, François and Eric Maurice, and Jim Rickard.

*From photographs of E. Maurice in EHPA.*

Main basis for the discussions was, after the definition of the Working Group's task, an extensive document prepared by the French delegation: "Mémorandum destiné à la discussion entre MM. Funke, Scheidemann et Alline, en vue de la rédaction du rapport demandé par le président du Conseil de l'ESO lors de la 12<sup>ème</sup> session de Conseil à Santiago, le 22 mars 1969" [14]. The French Memo dealt successively with the questions raised earlier: changes in the "Convention-size" of the telescopes; possible ways to speed up the work on the 3.6-m telescope; the structure of the ESO Management in Europe and Chile and the danger of too much dispersion in the latter, suggesting reduction of the "intermediate" stations La Serena and Pelicano between Santiago and La Silla; and the organization and presentation of financial and personnel matters.

## The Report of the Working Group

The report of the Working Group was dealt with by Council at its meeting of December 15 and 16, 1969 [15]. The Group arranged its advice into four sections: The ESO Programme and the Convention; Budget Procedures; The 3.6-m Telescope; and Certain Other Questions. To the first, the Group observed that departures from the Convention with regard to specifications of the instruments so far had been "more from the letter than [from] the spirit of the Convention" and had not involved any appreciable rise in costs [16]. As to the question, which projects to consider as belonging to the regular programme, it recognized the occurrence of borderline cases and it referred to CERN's example of realizing a bubble chamber not foreseen originally as part of the regular programme and including in its regular programme preliminary work for a storing ring project pertaining to the Supplementary Programme.

The Working Group recommended to Council "*a certain preparation for the continuous expansion*", so as to enable it to consider carefully whether new projects should be included in the regular programme. With regard to national telescopes, the Group recognized that they "*can become a worthy addition to the ESO instruments*", yet they "*--- would normally be allocated to the supplementary programme provision of --- the Convention or they would be wholly paid by the country concerned ---*" unless Council specifically incorporated them in the regular programme. With regard to budgetary procedures the Group recommended the adoption of a procedure similar to that used by CERN (see below). For the 3.6-m telescope project the Group recommended the preparation of a comprehensive status report and a detailed time- and cost schedule. Finally, the Group refrained from submitting any proposal concerning possible reduction of the dispersion of the facilities in Chile, and it suggested that Council reconsider its salary policy to make staff positions more attractive than they had been so far.

Judging from the minutes, the December 1969 Council Meeting took note of the report without extensive discussion. The meeting had a crowded agenda because of the succession in the General Directorate, and this did include as its principal item important reports concerning the 3.6-m Telescope Project which we will encounter later. Yet, there are several items in the memo and the Report which have distinctly left their mark on later developments in ESO and therefore are worth pointing out here.

First of all, this soul-searching had a sobering effect on the over-optimistic suggestions made by the SPC for extensions of the ESO facilities. However, Council appeared to remain receptive to the idea of the creation of an ESO Centre in Europe, where "*the most sophisticated equipment for evaluation should be located, astronomers from the ESO countries could work together and also, in collaboration, new instruments could be developed ---*". To



some extent, these wishes would be satisfied by the TP-Division created early in the 1970's.

With regard to financial and personnel matters, dissatisfaction among some Council delegates stemmed mostly from two causes: a lack of stability in the budget requirements, and lack of transparency in the documentation for Finance Committee and Council. The latter was not difficult to understand in view of the fact that the ESO Management had to set up an organization of unprecedented nature and size in astronomy, whereas most of the members of Council and FC were accustomed to streamlined procedures in well-established organizations.

For improving the situation, as a natural example Council tended to look at procedures established at CERN with its ten years longer experience (CERN was created in 1952). An important result was the introduction, in the early 1970's, of the so-called Banner procedure adopted by CERN for budget planning; I expect to return to this later when reviewing financial and personnel developments. In order to avoid misunderstandings it should also be recorded here, that the report of the Working Group explicitly stated that “--- *Management [essentially consisting of the Manager J. H. Bloemkolk and his staff] has accomplished its work in commendable fashion* ---”.

### **Creation of Committee of Council**

Finally, we note that at the March 1969 Council Meeting in Santiago the suggestion was made, by Alline, that ESO follow CERN's example by having a “Committee of Council” for the purpose of discussing in an informal manner, in between Council meetings and with restricted participation, those items which might give rise to controversies between the Council delegations mutually, or with the Directorate – and thus pave the way for smooth Council proceedings. A Committee of Council was established at the December 1969 meeting [17] and did function from the middle of 1970; its meetings are listed in Annex 5b.

### **ESO and the Creation of the Journal *Astronomy and Astrophysics***

It seems appropriate to devote in the present context a few paragraphs to the role ESO played in the year 1968 in the creation of the journal *A & A* which since then has become one of the leading astronomical journals, and still has an administrative link to ESO. Its creation, too, was one of the steps in the process of Europeanization of scientific activity. The close tie between the Journal and ESO, reported below, has led to the incorporation of the documentation related to the Chairmanship of the Board of Directors of the Journal over the first ten years of its existence, into the ESO Historical

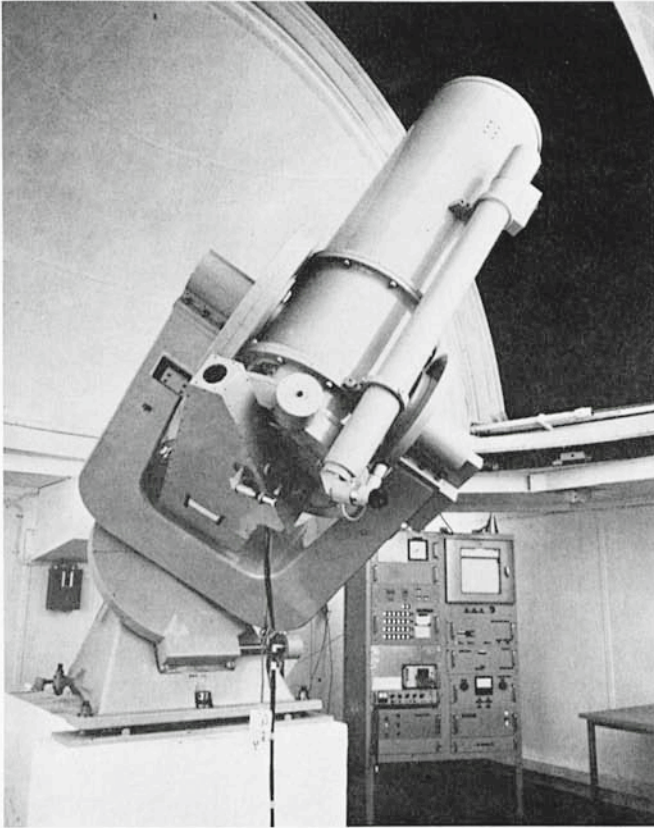

*The Copenhagen 50-cm Telescope, the second of the "national telescopes", shortly after it had been installed in its permanent dome in the middle of the year 1971. When it arrived on La Silla early in 1969 it was first mounted in the dome that had served earlier for the ESO 1-m telescope. The photograph shows it with the Copenhagen 4-channel photometer designed for photometry in the so-called Strömgren narrow-band system.*

*From EHPA.*

Archives. Accordingly, reference is made to these archives [18]; helpful has also been an earlier account by the author on the creation of the Journal [19].

On April 8, 1968 some leading astronomers from Belgium, Denmark, France, the Federal Republic of Germany and the Netherlands met at Leiden to prepare a possible merging of some of the principal astronomical journals

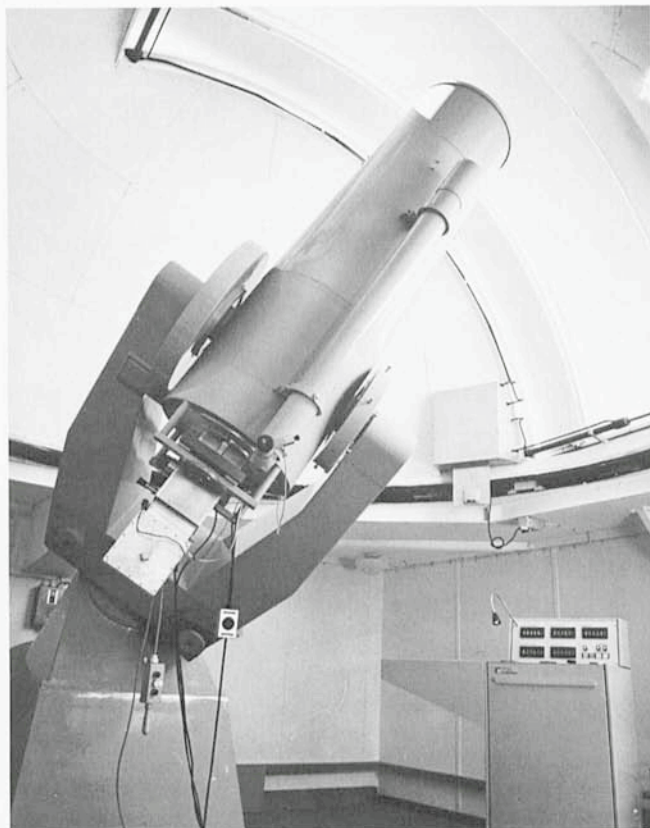

*The ESO 50-cm Telescope* shortly after its installation in late 1971. The telescope is a duplicate of the Copenhagen 50-cm telescope and was, like the latter, manufactured at Copenhagen. It was acquired by ESO in the context of developments for the control system of the 3.6-m Telescope so that these could first be tried out in actual practice on a small instrument. Initially, as in the above photograph, it was equipped with a one-channel photometer. Like the two 50-cm telescopes, their domes also are twins.

From EHPA.

that appeared in Europe [20]. The meeting had been convened by S.R. Pottasch of the Kapteyn Laboratory who, together with A. Reiz of Copenhagen Observatory and J.-L. Steinberg of Meudon Observatory had been the first to explore attitudes with regard to a possible merger; Pottasch and Steinberg were closely connected with editorial work for a journal in their

countries. The idea found general support and nine months later, per January 1, 1969, the first issue of the new journal appeared. The merging journals were: *Annales d'Astrophysique* (founded in 1938), *Bulletin Astronomique* (1884), *Journal des Observateurs* (1915), *Zeitschrift für Astrophysik* (1930), and *Bulletin of the Astronomical Institutes of the Netherlands* (1921), to which was added later the Scandinavian *Arkiv för Astronomi* (1948). First editors of the new journal were S. R. Pottasch and J.-L. Steinberg. The related series *A & A Supplements* appeared one year later, per January 1, 1970 under the editorship of L. L. E. Braes of Leiden, who was succeeded in 1971 by B. Hauck of Lausanne. The *Monthly Notices of the Royal Astronomical Society* refrained from merging, by decision of the Council of the Society on October 13, 1967 [21].

How did ESO come in? The April 1968 meeting had resolved that the affairs of the Journal should be supervised by a Board of Directors consisting of astronomers and representatives of sponsoring national organizations. This Board should be the autonomous owner of the Journal, including the title, with a private publisher acting as agent for the Board. However, in order to enter into a contract with the publishing agent as well as for other reasons, a legal status for the Board would have been required, the accomplishment of which for an international organization would have been a time-consuming and somewhat complicated affair. An alternative solution was therefore preferred: making use of the legal status of ESO, whose aims as a joint European astronomical programme ran parallel to those of the Journal. The matter met support by the ESO Council in July 1968, so that steps could be taken to prepare the necessary legal documents. These found final approval and confirmation at the December 1968 Council Meeting [22]. They were:

- a statement concerning the creation of the Journal and the relation of its board of Directors to ESO;
  - a formal agreement between ESO and the Board of Directors;
  - the contract between ESO and the publisher, Springer Verlag;
- and accordingly Council authorized the Director General of ESO to sign the contract just mentioned.

The basic idea was, that ESO would make its administrative and legal services available to the Board of the Journal but would carry no financial obligation or responsibility. Apart from making use of ESO's services, the Board would have an entirely independent status excluding influence from ESO side on its scientific policy. As a *trait-d'union* between ESO and the Board, the author, at that time Scientific Director of ESO, became a member of the Board of Directors – and was, in fact, chosen as its Chairman.

Henceforth, European astronomers would turn to the new Journal for the publication of their work – including that based on observations at La Silla.

## VIII. THE 3.6-M TELESCOPE PROJECT FROM CONCEPT TO THE LATE 1960's

*“Le programme initial de l’Organisation comporte la construction, l’installation et le fonctionnement d’un observatoire dans l’hémisphère austral, comprenant: a) un télescope d’environ 3 mètres d’ouverture; – – –”*

From the ESO Convention, Art. II.2.

### Introduction

This chapter reviews work towards the realization of the 3.6-m telescope from the early beginnings of ESO up to the moment, at the end of 1969, when Council drastically changed course. These early years saw an Instrumentation Committee, a Directorate and an engineering bureau devoted to the creation of an instrument of dimensions and costs, an order of magnitude larger than anything achieved so far in optical astronomy in Europe. Unfortunately, lack of experience proved to be a serious drawback, and this unavoidably puts its stamp on the present, somewhat gloomy, account. The new approach adopted by Council late 1969, will be described in the next chapter.

### Basic Concepts

A telescope project like the one for the ESO 3.6-m telescope, starts by specifying the dimension of the main mirror as this determines the light gathering power of the instrument, and by choosing the desired focal ratios for the different modes in which the instrument is to be used; the Prime focus, the Cassegrain focus and the Coudé focus. These focal ratios determine the dimensions of the telescope tube. The design of all other components of the project follows from these. It has been mentioned before (chapter IV) that the example ESO had in mind in the very beginning was the 3-m telescope of Lick Observatory, however the ESO design soon deviated from this.

Naturally, the designs of the various components of the project are interrelated, but once a certain stage has been reached, the further development and construction of the various parts tends to proceed largely indepen-

dently. For our project this was particularly so for, on the one hand, the housing of the telescope, i. e. building and dome, and on the other hand the ensemble of tube, optics and mounting. Within the latter again a subdivision can be made: the combination tube/optics, and the mounting plus drive. The account on the progress in the project can be subdivided accordingly. Up to the early 1970's, the progress of the project as a whole was determined almost entirely by the (lack of progress in the) design of the mechanical parts of telescope tube and mounting. Contrary to what seemed to have been a tradition in earlier generations of large-telescope building, progress for the ESO 3.6-m telescope was not determined by the completion of the optics.

### Early Conferences and Texts

The early years of ESO's project coincided with a general, international broadening of interest in large-telescope building and the publication of significant documentation. In the year 1960 appeared the compendium "Telescopes", Volume I of the series Stars and Stellar Systems edited by Gerard P. Kuiper and Barbara Middlehurst. It contained chapters by leading experts, among which descriptions of the two recently completed largest instruments: the 200-inch Hale Telescope by Ira S. Bowen, and the Lick 120-inch by W. W. Baustian; and furthermore chapters on Design of Reflecting Telescopes by Aden B. Meinel; and on Schmidt Camera's, again by Bowen. This Volume became a basic reference text for the next decades.

Another important event was IAU Symposium No. 27, "The Construction of Large Telescopes" held from 5 to 12 April 1965 at Tucson, Arizona, and at Pasadena and Mt. Hamilton (Lick Observatory) in California. The proceedings, edited by David L. Crawford and published in 1966, contained much basic information and instructive discussion reports. Among the participants from ESO countries were Baranne, Bahner, Courtès, Elsässer, Fehrenbach, Heckmann, Ramberg and the engineer who worked for ESO, W. Strewinski. In the present context mentioning should be made also of K. Bahner's Chapter "Teleskope" in *Handbuch der Physik*, Vol. 29, 1967, and Bahner's article "Large and Very Large Telescopes; Projects and Considerations" in ESO Bulletin No. 5 of December 1968, which includes a summary of large telescope projects under design or construction in December 1967.

Finally, as a quite useful – and readable! – review of the main elements in large-telescope construction and the status of the principal projects, let me mention B. V. Barlow's monograph "The Astronomical Telescope" of 1975 [1].

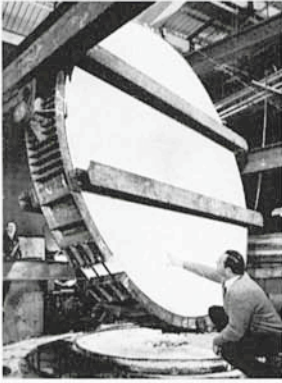

*The mirror blank for the 3.6-m telescope about to be delivered by Corning Glass Works. The right-hand photograph shows ESO's Director, Otto Heckmann, in discussion with a (yet unidentified) person of Corning's Management. The (undated) photographs were presented to ESO by Corning's.*

*From the EHPA.*

## **The Choice and Ordering of the Optics**

The increase of the originally suggested diameter of the big mirror from 3 to 3.5 m (eventually 3.6 m) was one of the outcomes of the visit of Fehrenbach and Heckmann to observatories in the United States in 1961 (see chapter IV). Experience with the recently completed Lick 3-m telescope had shown that the observers-cage at the prime focus was inconveniently narrow when used by a bulky observer. As, however, an increased diameter of the cage would block an unacceptably large part of the surface of the 3-m primary mirror for the infalling light, Heckmann and Fehrenbach suggested an increase of its diameter to 3.5 m [2]. The ESO Committee in its meeting of November 1961 took note of this, but thought it wise not yet to change the text of the Convention which was still in the process of being approved by the governments. For the time being, the formulation "un télescope d'environ 3 mètres d'ouverture" would leave the door sufficiently open for changing the size once signing and ratification would have passed. However, in the planning of the telescope, a mirror diameter of 3.5 m soon became the

canonical figure, and this grew to 3.6 m after it had turned out later – in 1967 – that the blank of 3.72 m diameter, as delivered by the manufacturer, Corning, allowed a useful diameter of at least 3.6 metre. In retrospect, it seems to have been ESO's good fortune that one of Lick Observatory's most ardent observers of the 1950's, apart from being highly respected scientifically, also was one of more-than-average circumference . . .

The order to Corning in its final form was placed on January 25, 1965. The blank, made of fused Silica, was accepted at Corning's (at Bradford, USA) on February 23, 1967 in the presence of Fehrenbach, Heckmann, J. Texereau (of the Laboratoire d'Optique of Paris Observatory) and J. Espiard of the firm of REOSC in Ballainvilliers, France, where the mirror was to be processed for its final shape. The contract with REOSC was signed in June 1967 and the blank arrived there later that year. After it had turned out in the course of 1968 that the blank showed certain superficial defects which required providing it with a new toplayer at Corning's, it was back again at REOSC in September 1969 for final processing. This was completed two years later; in February 1972 formal acceptance by ESO took place. By that time two studies of the properties of the mirror had been published. One, in 1967, by J. Texereau in collaboration with J. Espiard: "Examen du Disque en Silice Fondue de 372 cm pour European Southern Observatory", and one, in 1971, by G. Lemaître of Marseilles Observatory: "Sur la Flexion du Grand Miroir de 3,60 m de European Southern Observatory". These studies appeared in *ESO Bulletin* Nos. 2 and 8, respectively.

From the beginning, the design for the telescope aimed at using it in the three modes: Prime, Cassegrain, and Coudé focus. Exact values of the three focal ratios – F/3, F/8, F/30 – were chosen by the Instrumentation Committee (IC) after consultation with various observers in the United States among whom especially I.S. Bowen, the Director of Mt. Wilson and Palomar Observatories, should be mentioned. At the first Council meeting after the ratification of the Convention, in February 1964, Fehrenbach as Chairman of the IC summarized the situation as follows.

*"1 – Le télescope doit comporter un foyer Cassegrain ouvert à F/8 qui entraîne une ouverture du miroir principal comprise entre 2,7 et 3, le foyer Coudé ouvert à F/30.*

*2 – Un effort particulier doit être fait pour augmenter les champs de bonne définition. – – –*

*5 – – – Une combinaison du type Ritchey Chrétien ouvert à F/3 doit permettre d'obtenir:*

*– au foyer Cassegrain, ouvert à F/8, un champ plan de 30' de diamètre (Solution de M. Köhler).*

*– au foyer direct, un champ de 1° avec lentilles minces et de diamètre relativement petit, dont une de surface asphérique. (Solution de M. Baranne.)*

*– un champ suffisant au foyer Coudé."*





VIII. THE 3.6-M TELESCOPE





*In (August?) 1968 the blank for the 3.6-m mirror arrived again at the firm of REOSC in Ballainvilliers near Paris, for grinding and polishing towards its final shape. On these photographs: arrival of the mirror blank in its crate at REOSC, the wooden packing material and the iron ring holding the mirror being removed, and first hand-and foot acquaintance with the mirror by (in the foreground) Charles Fehrenbach (left) and André Couder (right).*

*From a set of photographs in the EHPA.*

elements was known as a Ritchey-Chrétien system after the names of the American and French opticians who developed it earlier this century. The combination chosen for the ESO 3.6-m is sometimes referred to as a Modified Ritchey-Chrétien or a Quasi Ritchey-Chrétien system.

For the extra reflecting components employed in the Cassegrain mode (one mirror) and in the Coudé mode (four mirrors), all of them sometimes referred to as “secondary optics”, the blanks were ordered in 1966 from the firm of Heraeus-Schott in the German Federal Republic and delivered in the

years 1968 and 1969. These also were made of Silica. Their figuring was included in the contract with REOSC and finished by them in the years 1970–1972.

By the time of the formal acceptance of the optical ensemble of primary and secondary mirrors in 1972, the Telescope Project had become the responsibility of the TP Division about which more in the next chapter, but in the course of the preceding years the work on the figuring and testing at REOSC had been accompanied by a small group of experts on behalf of ESO, of whom I should mention especially A. Baranne and G.J. Monnet of Marseilles, D.J. Malaise of Liège, A. Behr of Göttingen and K. Bahner of Heidelberg-Königstuhl.

### The Mirror Cells

Between the optical system and the telescope tube there is an important interface: the mirror cells. In them, the mirrors are carried permanently and in such a way that deformation of their shape (which would result in deterioration of the stellar image) is avoided as much as possible. This is no small requirement if one realizes that during the motion of the telescope tube while it “follows” the star, the mirrors assume continuously changing tilts and orientations. The problem was particularly pressing for the large primary mirror. This has, as mentioned, a diameter of 372 cm, and an average thickness of about 50 cm and a total weight of 10,970 kg. (For detailed specifications see the article by Lemaître quoted before.) The mirror derives its rigidity from this thickness, but this is not quite sufficient.

On the other hand, there is a limit to the thickness because an increase of weight leads to rapidly increasing demand on the sturdiness of tube and mounting and, hence, to rapidly increasing cost of the telescope. Compensation for the residual tendency to flexure of the mirror therefore was achieved by a support system placed under the mirror which acts through the force of gravity. It consists, for the ESO telescope, of a series of 30 concentrically placed and independently acting supports at the bottom side of the mirror, whereas at its sides the mirror is supported by three pads and a system of air cushions. Each of these 30 bottom supports is adjustable in itself but once the telescope is in operation, the supports cannot be adjusted from outside.

The design and manufacturing of the mirror cells was ordered from the firm of REOSC that also was to do the figuring of the mirrors. The reason is, that what is finally tested is the performance of the combination of mirror and cell as a unit. These combined units were delivered by REOSC in 1972.

At the moment this chapter is written, it is just in this domain of telescope design that a revolutionary improvement has been introduced: the “active optics” described in the *Messenger* of June 1989 and implemented in the New Technology Telescope. Modern techniques, including continuous computer

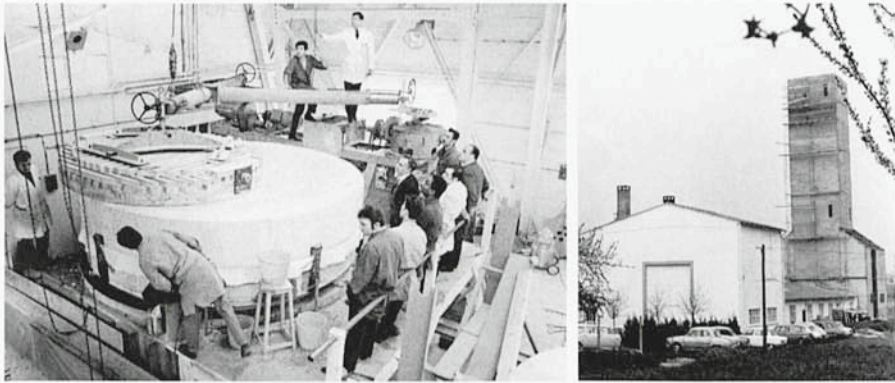

Shaping and testing the mirror at REOSC. Left: grinding the mirror (the large “white” disk) by means of the (smaller) rotating disk touching the upper surface of the disk. Among the spectators, the Director of REOSC, M. Bayle (in dark jacket in front of the group at right). Right photograph: the optical laboratory of REOSC at which the shape of the mirror was tested. In order to do this with the mirror in horizontal position, REOSC built the high “optical tower” at right in the picture.

From a set of photographs provided by REOSC in the EHPA.

control, have made it possible to abandon entirely the idea of rigidity of a mirror as achieved by its thickness. The solution towards the problem of obtaining optimal performance is found by taking advantage of a thin (and light!) mirror’s flexibility and steadily controlling its shape by a system of numerous and independent, but actively, from the outside adjusted supports. Twenty-five years ago, when Heckmann and his associates searched for the best support system for the ESO 3.6-m, this was undreamt of . . .

### **Tube and Mounting; Strewinski’s Pre-Design**

Fehrenbach’s summary of the recommendations of the IC by the time of the first Council meeting, in February 1964, also contained the following statement: “*L’étude de la mécanique de l’instrument devrait être fait par un bureau d’études indépendant, acceptant un marché d’étude.*” It confirmed the early intention of the ESO Committee to create a design bureau. In May of that year it had become clear that of the two engineers whose collaboration in the project was hoped for, the work for the large telescope would mostly involve Strewinski. According to Heckmann’s report at the June 1965

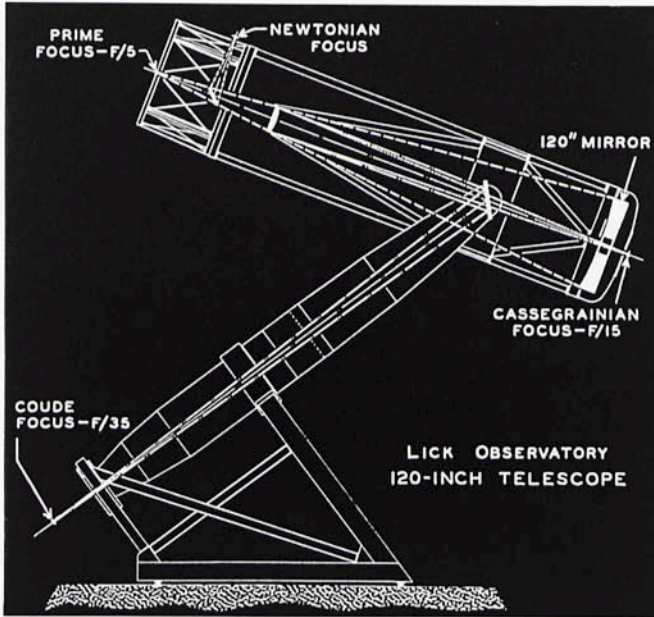

A sketch of the design of the 3-m telescope of Lick Observatory. In 1953, Walter Baade suggested that the principal telescope for the European Southern Observatory should be a copy of this telescope, which became operational soon afterwards. The sketch shows the telescope tube with its primary mirror of 3 metres and secondary mirrors for operation in the Cassegrain and Coude modes. For motion in declination, the telescope tube rotates around an axis which is mounted at the top end of two long fork prongs; the fork forming the extension of the polar axis.

From: *Sky and Telescope*, March 1955, p. 176.

Council meeting, a draft contract with the engineering bureau of Strewinski had been drawn up (but it is not clear whether it was ever signed). Ideas about the nature of the design were shaped within the IC, but they were influenced strongly by suggestions of Strewinski.

Strewinski's design deviated in several important respects from that of large telescopes then in operation. First, note that the whole concept was still based on the classical model of a telescope moving around a polar axis (which is directed towards the celestial pole) and the declination axis, perpendicular to this. Of these two motions, only the first (and uniform) one is required

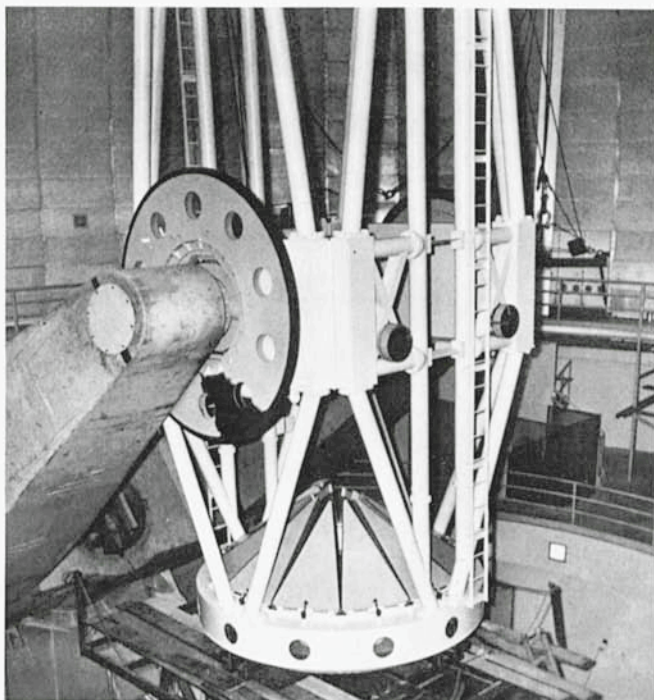

*The Lick 3-m telescope when its mounting was virtually complete, in November 1954. The lower part of the telescope tube is shown, hanging on the declination axis at the top end of its long fork, the arms of which are about 7 metres long. The weight of the tube including the optics is about 40 tons (whereas the estimated weight for the ESO 3.6-m tube and optics was about 60 tons).*

*From: Sky and Telescope, May 1955, p. 272.*

during the telescope's following a star during observation. The radically different azimuthal design now employed for large optical telescopes was in use at that time only for large radio telescopes, and it was planned for (and later realized in) the 6-m USSR optical telescope in the early 1960's.

One of Strewinski's innovations concerned the storage of the optical elements which are alternately used for the different modes of operation. Whereas, for instance, at the 200-inch Palomar telescope those optical elements, which are not in use during operation in a particular mode, remain stored within the telescope tube, Strewinski proposed for the ESO telescope

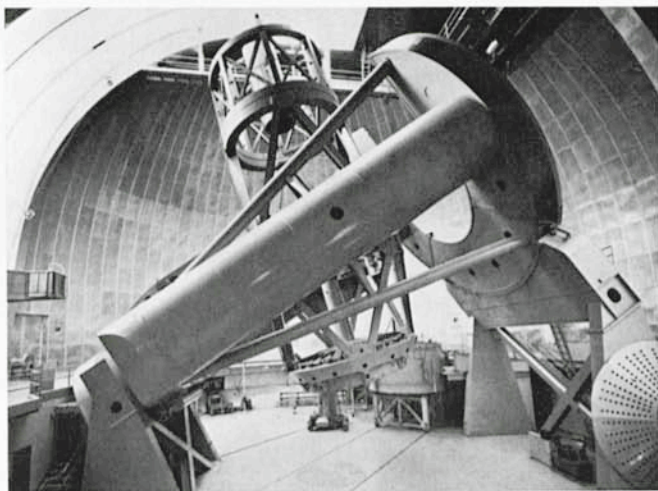

*The 5-m Hale telescope of Palomar Mountain, shown here, had been in regular operation for four years when first talks about the creation of ESO took place in 1953. Its realization had taken many years due to interruption by World War II. The declination axis is positioned about half way between the south and north bearings of the polar axis so that the weight of telescope tube and polar axis is divided over the two bearings. The horse-shoe shape of the north bearing allows the telescope to observe objects near the north pole.*

separate top ends of the tube carrying the different secondary mirrors, so that those not in use could be parked outside the tube in quickly interchangeable manner. An advantage of this solution was a reduction of the weight of the tube, and hence, simplification of the design and reduced costs of the mounting.

Another aspect of Strewinski's design was the combination of horse-shoe and fork mounting. In the classical mounting, realized, for instance, in the Lick 120-inch and also in the ESO 1-m and many other telescopes, the extremes of the declination axis rest in the extremes of the two prongs of a fork which forms an extension of the polar axis. For large telescope tubes, the top end of the fork which carries all the weight of the tube including the optical elements, is rather distant from the upper bearing of the polar axis, particularly so if the fork is made long in order to leave room for bulky equipment at the Cassegrain focus. This implies a risk of vibrations of the fork and high demands on the system of bearings of the polar axis, and in the



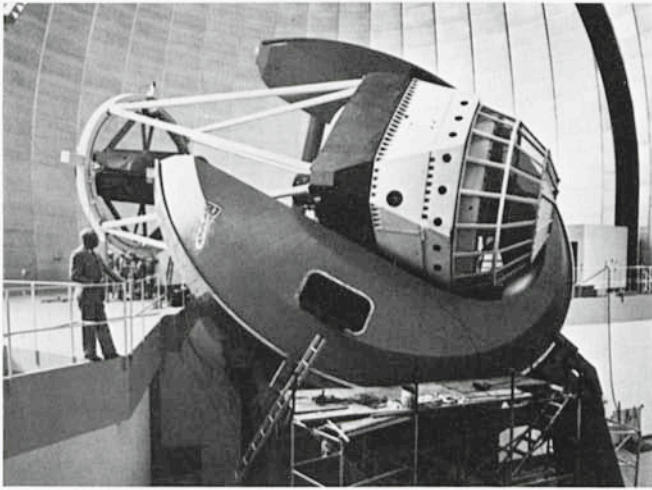

*The 4-m Mayall telescope of Kitt Peak Observatory came into regular operation in 1974 after its creation had been initiated in the early 1960's by AURA. As in the case of the 5-m Hale telescope, the north bearing of the polar axis has the shape of a horse-shoe, but now the declination axis lies in the plane of the horse-shoe. This solution was considered for the ESO telescope, too, by Strewinski, but he preferred the solution described below in order to avoid the large diameter of the horse-shoe.*

*From Sky and Telescope, January 1973, p. 14.*

case of the ESO telescope especially so because at La Silla the axis makes an angle of  $29^\circ$  only with respect to the horizon. An impression of the weight we are dealing with may be obtained from the minutes of the 28th meeting of the IC, of May 1969, when the tube including the optics was estimated to weigh about 60 tons.

A different concept had been adopted for the Kitt Peak 150-inch telescope. Here, the bearings carrying the extremes of the declination axis rest in a very sturdy horse-shoe which in itself forms the upper bearing of the polar axis. Even without detailed knowledge of the forces acting on the bearing, one senses that for a heavy telescope tube such a design is more suitable than a fork mounting. A solution like this was considered by Strewinski also for the ESO telescope. However, he rejected it in order to avoid the large diameter which would have been required for the horse-shoe, about 12 m. As Ramberg explained in his presentation of Strewinski's design at the April 1965 IAU Symposium, Strewinski feared "that it will be a fairly complicated

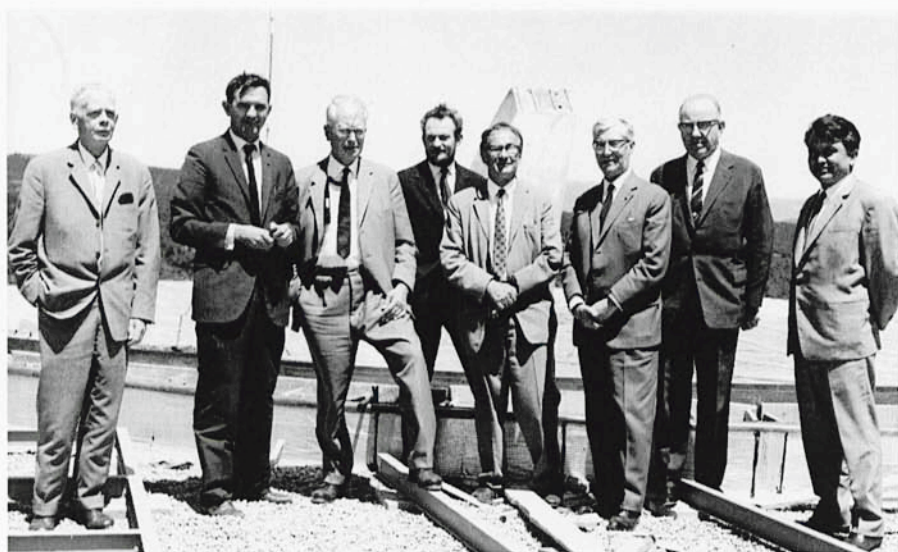

*The engineer W. Strewinski (extreme left) visiting Observatoire de Haute-Provence in May 1966 with the ESO Instrumentation Committee and other specialists. From left to right next to Strewinski: Ch. Fehrenbach, O. Heckmann, Parise (a collaborator of Fehrenbach) A. Behr, A. Couder, M. Migotte, and A. Baranne. Main features of the mechanical design of ESO's 3.6-m telescope and Schmidt telescope are due to Strewinski who had been engaged by ESO soon after its creation. Early in the 1970's the ESO TP Division at Geneva took over for the realization of the 3.6-m telescope, as will be described in chapter IX; for the completion of the Schmidt telescope see chapter X. The photograph was taken on the roof of the Spectrographic Telescope Building-in-construction at Haute-Provence Observatory.*

*Photograph in envelope marked "Spectrographic Telescope" in the EHPA.*

matter, after having manufactured such a disk in Europe, to transport it to Chile and then take it up to the top of La Silla ---" [4], and Ramberg mentioned this also at the December 1965 meeting of the IC.

### **The Combined Horse-Shoe and Fork Mounting**

This led Strewinski to his compromise solution: the combined horse-shoe and fork mounting. It is demonstrated in the accompanying drawing, taken from the presentation in the 1965 Symposium Report. Here, the declination axis is supported by two relatively short and very strong fork prongs mounted

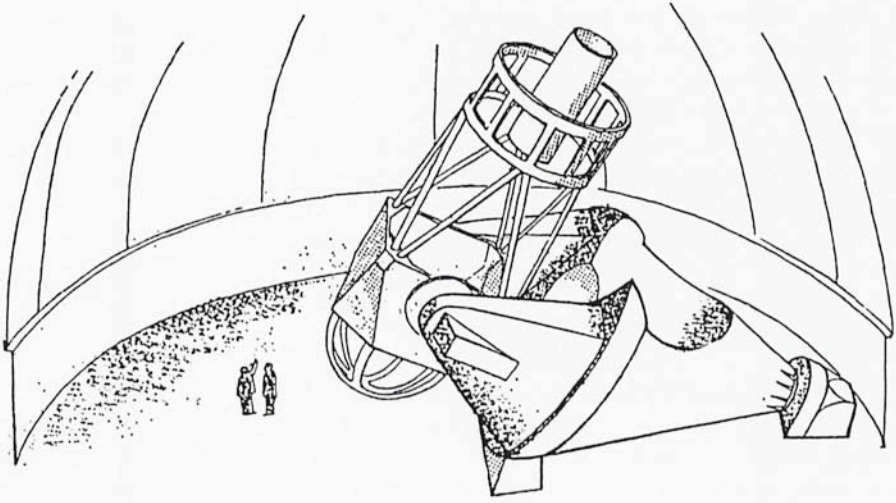

*The design for the 3.6-m telescope as presented by Strewinski at IAU Symposium No. 27 on "The Construction of Large Telescopes" in April 1965. In order to reduce both the length of the fork arms as required for the Lick 3-m telescope design, and the large diameter of the horse-shoe as realized in the case of the Kitt Peak 4-m telescope, Strewinski proposed the combined fork and horse-shoe solution shown here. Another feature of his solution was a spherical shape for the horse-shoe bearing, and positioning the centre of gravity of telescope plus polar axis vertically above the line joining the two oil pads which carry this bearing.*

*From The Construction of Large Telescopes, IAU Symp. No. 27, Ed. D.L. Crawford, 1966, p. 118.*

on the horse-shoe disk. By this construction the diameter of the horse-shoe could be diminished to less than 8 metres. For the upper (horse-shoe) bearing Strewinski chose an oil bearing, the sliding surface of which is supported on two fixed pedestals, and in Strewinski's design the centre of gravity of the movable parts of the telescope is vertically above the midpoint of the line joining these two oil pads. Oil is constantly pumped at high pressure into the two sliding surfaces, so that during the operation the telescope floats on two thin films of oil. The sliding surfaces of this upper bearing were given a spherical shape, a concept Strewinski had earlier introduced for the Schmidt telescope of Hamburg Observatory.

Once these principal design characteristics had been agreed upon – and we do recognize them in the 3.6-m telescope as it has ultimately been realized – many details had to be worked out in close consultation between the bureau of Strewinski, the Directorate and the IC and its subcommittees. They met frequently in the year 1966 and thereafter. This led to the so-called pre-design studies and drawings in which specific solutions were formulated for the various technical problems encountered. Next should follow the exact designs required for the construction when the project would be in the hands of the manufacturer.

### Stagnation – and Growing Impatience

These pre-design studies and drawings were, however, produced at unexpectedly low rate by Strewinski's bureau. The Directorate, especially Heckmann, in first instance kept full confidence in Strewinski to handle the task, but doubts began to grow among the IC and Council when a year after the Large Telescope symposium little progress was evident. In his report at the Council Meeting of April 1966 in Santiago (following the dedication of the road on La Silla), Fehrenbach felt compelled to state:

*“Il faut considérer que l'étude du grand télescope est arrivée au stade où il est nécessaire de penser à sa réalisation dans un délai raisonnable. Un certain nombre de membres de la C.I. m'ont indiqué, en privé, leur inquiétude concernant la méthode proposée.*

*D'après des informations, nos collègues américains prévoient un bureau d'études de 50 ingénieurs et techniciens, travaillant pendant plusieurs années pour l'étude complète de leur télescope de 3,75 m à Kitt Peak. Il est certain que l'organisation prévue par nous, c'est à dire un bureau d'étude réduit, par ailleurs chargé de l'étude du télescope de Schmidt, ne permet pas une réalisation dans un délai acceptable. Je me demande s'il ne vaudrait pas mieux passer la commande de la mécanique à une firme privée, le bureau d'étude de M. Strewinski restant organe de liaison entre cette firme et la C.I.”*

Concern about the lack of progress in the pre-design continued to be expressed at meetings of Council and IC. A year later, at the June 1967 meeting of Council, it was agreed that *“although the quality of Strewinski's work is excellent, the capacity of his bureau is evidently too small – – –. A solution would be to give the main part of the definitive design to a large firm which then could work under the supervision of Strewinski.”* However, suggestions to give part of the pre-design to an outside firm met strong opposition from the part of Heckmann, who emphasized *“that the pre-design forms a unit; – – – It would be a considerable loss of time to give the task – – – to another firm, because no firm exists holding something like Strewinski's specific knowledge on the subject.”*

Again a year later, in the July 1968 meeting of Council, Fehrenbach on behalf of the IC reported that Strewinski was supposed to deliver the complete pre-design, drawings and descriptions, before June 1, 1968 but that this had been delayed due to the necessity for Strewinski to enter deeply into parts of the definitive design . . . In fact, the first part consisting of 34 drawings, mainly related to the telescope tube, was delivered only in November 1968 and extensively discussed by the IC in January 1969, whereas the second part, also 34 drawings, for the telescope mounting, was delivered in May 1969 and discussed by the IC in May and June 1969. As these three meetings were the last ones of the IC before the policy of Council was radically changed, and the creation of the Telescope Project Division was on the horizon – the IC would meet again only a year later, in June 1970 –, let me briefly describe the proceedings of those IC meetings in 1969.

### **The IC Meetings in 1969**

The meeting in January 1969 was almost entirely devoted to the design of the telescope tube. Items discussed were: technical solutions for the secondary mirror exchange when the observer changes his mode of observing; the stability of the position of the primary mirror during exchange of top parts of the tube, when the mirror is in vertical position; the interchange of equipment used at the prime focus; the design of the mirror supports; specifications and design of the Cassegrain cage; and the design of the drive system. Items taken up in May 1969 were: the (very important!) question of the flexure of the fork prongs in different positions of the tube; the design of the south (upper) bearing and the safeguard against earthquakes; the choice of the (mechanical?) drive system; the control of “mirror 5” of the Coudé system.

During the second part of this meeting, a small ad-hoc group consisting of Strömberg (as Chairman), Fehrenbach, Heckmann, Ramberg and Strewinski convened separately. It subsequently reported to have found Strewinski’s pre-design sufficiently advanced that preliminary steps might be taken towards the implementation of the project, and it suggested names of firms to approach for first contacts. Strewinski would be supposed to continue the detailed design work but should rather not be involved in shop-drawings unless he would increase his staff by 10 to 15 engineers and draftsmen. A time schedule was proposed for the ordering of parts: for the period October 1969 to April 1970 these should include the main parts of the mounting, and subsequently, until October 1970, the main parts of the telescope tube. In a third period, until April 1971, the ordering of the telescope drive and mirror support systems were foreseen. Presupposition would be that Strewinski would settle for this time-schedule contract. Strewinski himself recommended collaboration with a local firm.

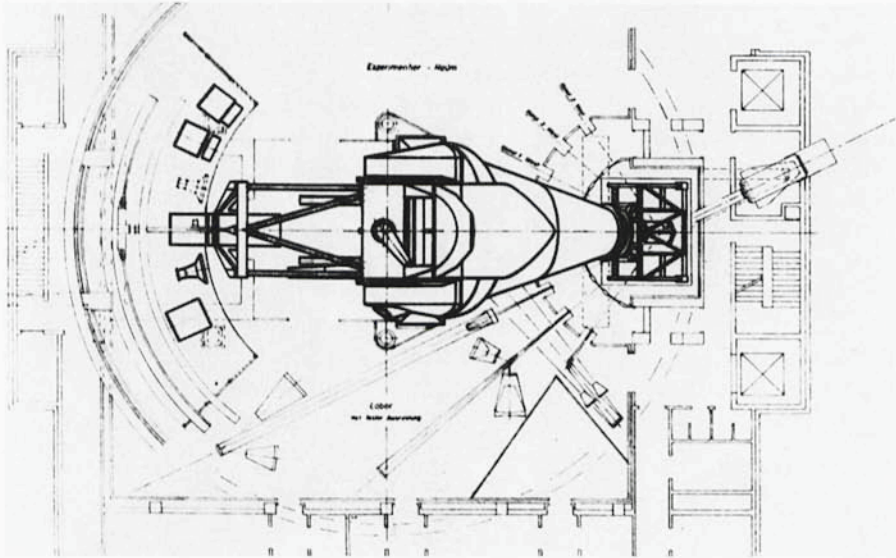

The drawing reproduced here is part of a set made by the bureau of the engineer Dr. W. Strewinski and marked "Gesamtanordnung" and "Stand 18-10-1968". This set of drawings was reproduced in Document Cou-59, written by ESO's Technical Director J. Ramberg for the Council meeting of December 1969 and entitled "The Present State of the 3.6 m Telescope Project". This section shows the arrangement proposed by Strewinski for the storage of the different top-ends of the telescope tube which carry the secondary mirrors for use in different modes of operation.

The proposal led to the more detailed design by the TP Division shown in the sketch at right. We also note, albeit vaguely, in the above drawing the square contour of the telescope building extending beyond the projection of the dome, a design that followed from the large space deemed necessary for the long optical paths in the Coudé spectrographic equipment. The design of the final, cylindrical, telescope building on La Silla represents a radical change, introduced in the early 1970's.

However, doubts were expressed – particularly from the part of S. Laustsen (about whose role in the project we will see more below) – whether the time schedule was realistic: "An efficient group of astronomers and engineers is necessary for the planning and coordination of the whole 3.6-m project and for the design studies and development work bearing on control and automation" [5].

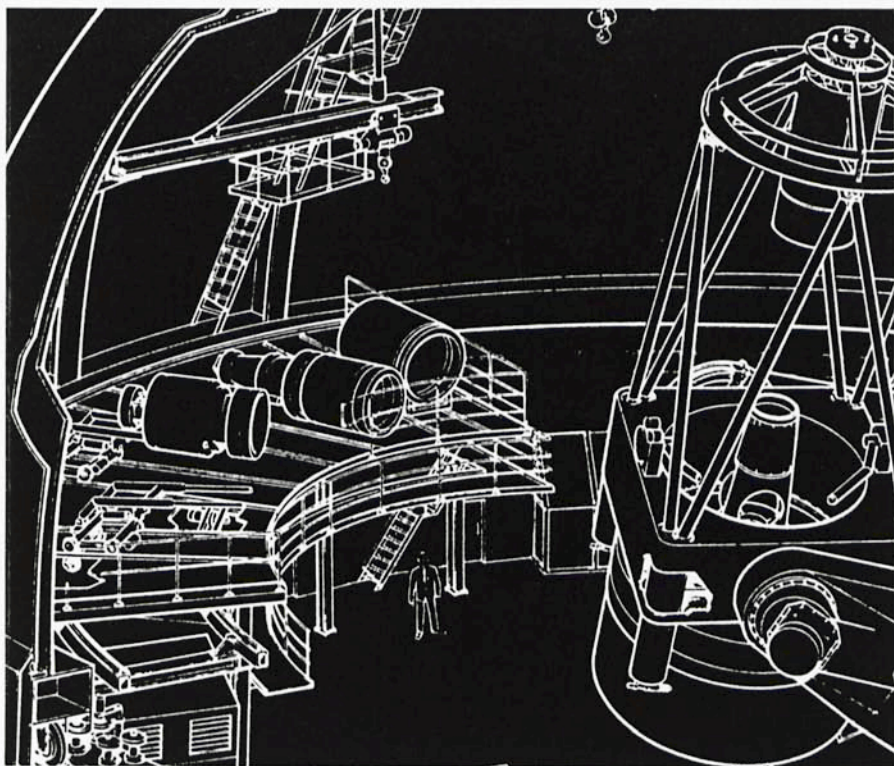

In the June meeting, four weeks later, aspects of the design of the Cassegrain cage and the Coudé mirror system were reviewed, after which Heckmann globally summarized still pending matters: mounting of the Coudé mirror; Cassegrain cage; facilities for optical adjustments; mirror support systems; prime focus correctors and plate holders; drive system; encoders; computer control interface. However, no decision was taken with regard to a recommendation to Council for entering contacts with construction firms as had been suggested at the May meeting. A next meeting of the IC was scheduled for October 1, 1969, but not held.

As described in the previous chapter, around this time – the middle of 1969 –, dissatisfaction about the lack of progress was one of the reasons for creating the Working Group of Alline, Funke and Scheidemann. A worried Council considered alternative ways to realize the telescope, and the role of Strewinski's bureau was more and more confined to the completion of the Schmidt telescope. We shall come back to the Schmidt in chapter X, and before entering the description of the new approach for the 3.6-m telescope review what had been done on the design of the telescope building and dome and in the field of automation.

## The Building

Once the main properties of the telescope had been fixed, steps were taken toward the design of building and dome. At its November 1966 meeting, Council, at Heckmann's request, agreed that this project should be handled separately from the building projects of the first stage of which we described the dedication in chapter VI. In order to allow close consultation, a civil engineering firm in Hamburg was chosen, Lenz Architekten & Ingenieure. Their architect Mr. Mix gave a first report at the IC meeting of December 19, 1967. From the minutes of this meeting [6] main features of the design can be inferred, but unfortunately no drawings have so far been located in the ESO files. A basic feature of such a telescope building is its consisting of two parts on separate foundations: part A for the support of the telescope and its auxiliary equipment such as spectrographs, and part B supporting first of all the heavy rotating dome, but also serving for electronic laboratories, dark rooms, storage space, laboratories, aluminizing facilities, air conditioning, elevators, etc. Reason for this separation of structures is that no vibrations caused by the activities in part B should be transmitted to the telescope and its auxiliaries of part A (for instance those caused by the rotation of the dome).

An important feature of structure A was a large floor below the observing deck for the erection of the Coudé spectrographs; these, together with the size of the dome, became the determining factor for the horizontal extension of the building. A length of 24 metres for the Coudé light path figured in early planning, but was reduced to 18 m at most by November 1966. The diameter of the dome was estimated to be 28 metres [7]. Throughout the designing by Lenz, the result of the special requirements for the Coudé floor was a building of rectangular shape which risked to have a deteriorating effect on the image quality in the telescope.

Another basic measure was, of course, the height of the telescope above ground level. This was defined as the height of the crossing point of declination axis and polar axis, and fixed at 24 metres. The decision to put the telescope that high goes back to the results of measures of image quality at different heights above ground level by the method of Siedentopf described in chapter II, for which data had been obtained by André Muller over a long period by means of high masts, one of which was erected at the highest summit of La Silla. Note that it was this element, the required image quality, that determined the height of the building, not the need of space for housing the various facilities.

Of the many other aspects of the design, let me mention only the important problem of providing proper heat insulation in order to avoid heating up of the inside of the dome during day time.



In the July 1968 meeting of Council, Ramberg could report that the firm of Lenz expected to finish the pre-design by the end of that month, and in the December meeting first steps for a building contract were discussed. However, the delay in the design of the telescope kept Council and Directorate from taking these steps.

## **The Dome**

Simultaneously with the planning of the building, preparations were made for the design of the dome. Favourable experience had been gained with the firm Scibert-Sécometal at Saarbrücken, that had provided the domes for the first construction phase. This early work had been supervised by their engineer W. Bauersachs, who has described it in *ESO Bulletin* No. 4 of July 1968 (and who years later joined the staff of ESO). Hence, this firm was now also charged with the design and construction of the dome for the 3.6-m telescope. This was finished by the end of 1968, and so this project, too, was ready for tendering in 1969.

## **Automation in Telescope Control**

Among the many valuable experiences of Fehrenbach and Heckmann during their visit to observatories in the United States in 1962 was the confrontation with new, electronic computer techniques for the control of telescope functions. This rapidly developing field was also energetically pursued in the ESO member states and led to a document "Some Suggestions for Automation of the 3.6-m Telescope" issued by the ESO Directorate in February 1968 under supervision of the Technical Director Jöran Ramberg [8]. The authors included two young astronomers, F. Dossin of Liège who had joined the office of the Director in February 1966, and S. Laustsen of Copenhagen Observatory who acted as consultant to the Directorate.

Main functions of the automation as listed in the document and elaborated in detail were: A) Automatic Control: setting of the instrument, telescope driving, dome and shutter operation, setting and driving of siderostate, and "local driving", and B) Semi-automatic operations (push-button control). The new concepts were discussed in a series of meetings: in February 1968 in Paris, in September 1968 in Karlsruhe at the firm of Siemens (in view of a collaborative project with this firm) [9], and at the IC meetings of November 1968, and May and June 1969.

Meanwhile, Svend Laustsen had become a staff member of ESO per September 1968, in order to assist the Directorate in matters of automation of telescope operation and for the development of a programme for auxiliary instrumentation for the 3.6-m telescope. Gradually, an in-house working

group was formed headed by Laustsen, which by the end of 1969 also included the astronomical technician B. Malm and the electronics engineer M. Blichfeldt, both also from Denmark. It continued to grow in 1970 and would become the nucleus of the 3.6-m Telescope Division; the creation of which we shall describe in the next chapter.

Whereas in the early phase of ESO, the three telescopes, 1-m, 1.5-m, and the Schmidt, as we saw in chapter IV, could be identified with the specific interests of institutes in the Netherlands, France and the German Federal Republic, respectively, it now had become Denmark's turn by providing this nucleus.

## **IX. THE 3.6-M TELESCOPE PROJECT DIVISION; ESO COLLABORATES WITH CERN**

*“ --- practically everyone [on the CERN Committee of Council] --- emphasized the scientific importance of the collaboration between astronomy and high-energy physics and common technical developments --- ”.*

From a letter of C.J. Zilverschoon (CERN) to the author of November 27, 1969.

In the second half of 1969, Council and ESO Directorate changed course in the effort to realize the 3.6-m telescope. Within the ESO management, but in close consultation with Council members, collaboration with other scientific organizations or with industry was contemplated as an alternative to relying entirely on the engineering bureau of Strewinski.

### **ESO Approaches CERN**

For several reasons, ESO tended to turn first of all to CERN. CERN developed powerful and sophisticated instrumentation; the scientific, non-profit aims of the two organizations were similar; CERN's Rules and Regulations for personnel and its administrative procedures had served as a model for those of ESO, and as we saw in chapter I, the ESO Convention had been shaped to a large degree after that of CERN. An interesting and important circumstance was also that for three of the six ESO member states, government delegates in the CERN and the ESO Councils were the same person: from the time of the ratification of the ESO Convention in 1964 till the early 1970's, this had been the case for Denmark (O. Obling), the Netherlands (J.H. Bannier) and Sweden (G. Funke). Moreover, the ESO Council members for the Federal Republic of Germany and for France, C. Zelle (from 1970) and A. Alline (from 1969), respectively, had been members for several years of the CERN Finance Committee. Thus, there was much common ground between the governing bodies of the two organizations and ample possibility for informal consultation [1].

Deliberations crystallized at a meeting at CERN on October 21, 1969. Present were from CERN: its Director-General Bernard P. Gregory, the Director of Administration George H. Hampton, and C. ("Kees") J. Zilver schoon, Head-Engineer associated with the construction of the Intersecting Storage Rings. ESO was represented by Heckmann, Ramberg, Blaauw and Bloemkolk of the Directorate, and Fehrenbach as Chairman of the Instrumentation Committee. An extensive report on the meeting, dated November 10, 1969, was written by Ramberg [2]. After introductory presentations on general CERN procedures for handling large instrumentation projects and on the current situation of the 3.6-m Telescope Project, possible ways of collaboration were explored. Not only the case of the 3.6-m telescope was considered; reference was also made to the recent proposals of the SPC for three powerful telescopes described in chapter VII (a large photometric telescope, a "big Schmidt", and an astrometric telescope).

The most attractive arrangement appeared to be what we shall call the "incorporation proposition": ESO would create the staff positions that would be required according to CERN experience for a project of the (financial) size of the 3.6-m telescope, and make these available for an ESO set-up at CERN. The group would follow CERN rules and grades and salary scales, and be under the jurisdiction of the Director General of CERN, whereas the ultimate scientific responsibility for the project would remain under the Director General of ESO. The draft organigram proposed at the meeting is reproduced in Ramberg's report. Even farther reaching collaboration was briefly discussed, including the possibility of common research projects and close physical neighbourhood of the two Headquarters. A time schedule was drawn up leading to completion of the telescope project on La Silla about six and a half years after the beginning at CERN. An essential feature of the proposed arrangement would be the continuous availability of CERN expertise – technical and administrative – and even CERN making personnel available to ESO "on loan" for limited periods.

As a first step following the meeting, Ramberg on behalf of the ESO Directorate sent on November 12, 1969 the following telegram to the President of the CERN Council [3]:

*"In view of the recent informal discussion between the Director General of CERN and the Director General of the European Southern Observatory, on which occasion a mutual interest in exploring a collaboration between the two organizations was expressed, we respectfully submit for your meeting of the Committee of the CERN Council a request to explore the possibilities for such a collaboration within CERN."*

As the President of the CERN Council, G. Funke, also was a member of the ESO Council (and had been its President over the years 1966–1968!), understanding for the situation could be taken for granted, and the matter was duly submitted to the CERN Committee of Council in its meeting on the

next day, November 13. The reaction was very encouraging. In a letter of November 27, 1969 addressed to myself, Zilverschoon informally reported as follows (in translation by me from the Dutch text):

*“As you may have heard from Banner, our Committee of Council has very favourably received the proposition of collaboration with ESO.*

*It was remarkable that practically everyone — — — entirely lost sight of the original aim, the construction of the telescope, and rather emphasized the scientific importance of the collaboration between astronomy and high-energy physics [and] common technical developments such as data handling and the political aspect: formation of a “Communauté scientifique européenne”, in which there would be room also for other organizations for fundamental science. England, too, was quite positive. We expect that our Council in December will approve continuation of the discussion. — — —.”*

Kees Zilverschoon, the author of the above letter, would in subsequent years become a devoted counselor to ESO's TP Division.

### **Consultation with ESRO**

CERN was not, however, the only sister organization approached by ESO. The other one was ESRO, the European Space Research Organization, predecessor of the European Space Agency. On November 14, 1969 I visited its Director General H. Bondi at ESRO Headquarters in Paris [4]. Bondi, too, reacted quite positively. However, as space-engineering differs quite a bit from ground-based work in that the requirements for space-proof products make them considerably more expensive than those that, if needs be, can be reached by a ground-based technician, cost estimates soon pushed this perspective for collaboration into the background.

### **The Documents Cou-59 and Cou-60 of December 1969**

Parallel to these talks between ESO and CERN ran consultations between Council and myself as a candidate for the succession of Heckmann in the General Directorate. I had been approached by Council on this matter early in 1969, and this led to a formal offer by the President of Council, J.H. Banner, of June 30, 1969, containing the following passage: “Council considers the successful construction and erection of the 3.6-m telescope as a priority task of the Organization for the next few years, and would be happy to hear how you think that you can best discharge your responsibility in this respect. The Council is willing to discuss with you any proposals you would like to make, even if these would imply changes in the structure of, or a different division of responsibilities within, the Organization. Council would be pleased to receive such proposals early enough to be able to discuss them in the meeting of 15 and 16 December 1969.” [5].

Half a year later, for this meeting Council had at its disposal two documents for discussing its policy. One was "The Present State of the 3.6-m Telescope Project" (Doc. Cou-59), compiled by the Technical Director J. Ramberg [6], the other the "Memorandum on Further Development of the 3.6-m Telescope project and on Possible Collaboration with CERN or/and ESRO" (Doc. Cou-60), by myself [7].

Document Cou-59 summarized the situation by the end of 1969, including a breakdown of the cost estimates for the various components of the project. As this situation has been reviewed in the previous chapter, we need not present here again Ramberg's summary. I shall return to the cost estimates of Cou-59 in chapter XI.

Cou-60 consisted of three parts. The first one discussed ways of proceeding with the project with special reference to the possible collaboration with CERN, the second part discussed further aspects of the collaboration with CERN including the proposition that the ESO Headquarters should move from Bergedorf to Geneva, and the third one briefly dealt with concern about the position of the ESO project relative to certain national projects in astronomy. In the present context I shall only refer to the first part, and in chapter XI return to the remaining part.

Starting point for part I was a compilation, prepared by Heckmann, of possible ways one might choose from in the case of involvement of industrial firms, with varying degrees of participation by Strewinski's bureau. A solution of this kind would have been preferred by Heckmann, but none of those suggested seemed attractive in comparison with the prospect of collaboration with CERN. With reference to the growing internal technical group headed by Laustsen and described in the previous chapter, the document elaborated on how this Group might operate in conjunction with CERN, and it expressed preference for the "incorporation proposition", the closest of the forms of collaboration sketched at CERN on October 21. It recognized, though, that besides the many advantages of this solution (notably CERN's established experience in non-profit scientific instrumental development), there was the danger that the negotiations with CERN might lead to longer delays than negotiations with private firms. In the most favourable case they might lead to complete clearance at the June 1970 CERN Council meeting. A complicating, uncertain element in the discussions were the financial implications of the two forms of collaboration, with CERN or with industry.

The ESO Council meeting of December 1969 reacted by creating a number of staff positions required for the work of the Laustsen Group and encouraged the (future) Director General to further pursue the negotiations with CERN, although more information on industrial participation remained desired. Most outspoken in its preference for CERN was the French delegation. Let me quote part of the statement of its member, the astronomer André Lallemand:

*“La réalisation de ce grand télescope est à la limite de nos possibilités techniques, toujours parce que l’expérience à cette échelle nous manque en Europe.*

*Ce que je vais dire n’est aucunement une critique de l’excellent travail fait par le Comité des Instruments et par les ingénieurs qui ont travaillé au projet, mais il suffit de lire le document Cou-59 du 8 décembre 1969, pour être persuadé de cette inexpérience. — — —*

*Ceci montre que l’ESO a un besoin impérieux de l’assistance d’un organisme expérimenté, ayant l’habitude de traiter des questions semblables et de même envergure, et d’un organisme n’ayant pas des fins et des activités à caractère commercial et lucratif. Cette assistance nous l’avons trouvée au CERN et devant l’ampleur des difficultés que nous allons rencontrer, je souhaite qu’elle soit la plus large possible. — — —*

*On peut rêver à ce que pourra être l’ESO dans le futur, il est agréable de penser que non seulement l’ESO pourra fournir des moyens d’observation extrêmement puissants, mais qu’elle pourra être aussi un centre culturel où les astronomes européens pourront travailler en étroite collaboration, et où les théoriciens et les observateurs pourront échanger leurs idées et leurs résultats, mais — — — Il faut d’abord réaliser vite et bien notre grand télescope, cette réussite est l’enjeu de l’existence même de l’ESO.”*

The German delegation, on the other hand, insisted strongly on exploring more extensively industrial participation.

### **Pursuing the In-House Group Concept: Doc. Cou-66**

After the December 1969 Council meeting, parallel to pursuing external participation, the ESO Directorate worked out a scheme for realizing the telescope by means of a powerful in-house technical group. This led to the important document Cou-66 “The ESO 3.6-m Telescope Project” that became the basis for further policy decisions. It was prepared at the Bergedorf office by the working group for the development of telescope operation and auxiliary instrumentation (of which I mentioned the creation at the end of the previous chapter): Laustsen and his associates Blichfeldt, Malm and Scharnweber, with the advice of the Technical Director Ramberg. It was presented to the Committee of Council for its meeting of May 6, 1970 and had three points of departure:

*“A. ESO must form its own group of astronomers, engineers, etc. which group shall be able to conduct the project through all its phases including the first period of operation of the instrument in Chile.*

*B. The group must at any time have all parts of the project under firm control. But — — — a major part of the design work and all construction work will have to be done by consulting and manufacturing firms.*

*C. — — — For its task in Europe [the group] should be located in a scientific and technological milieu and be offered good service facilities.”*

IX. THE 3.6-M TP DIVISION

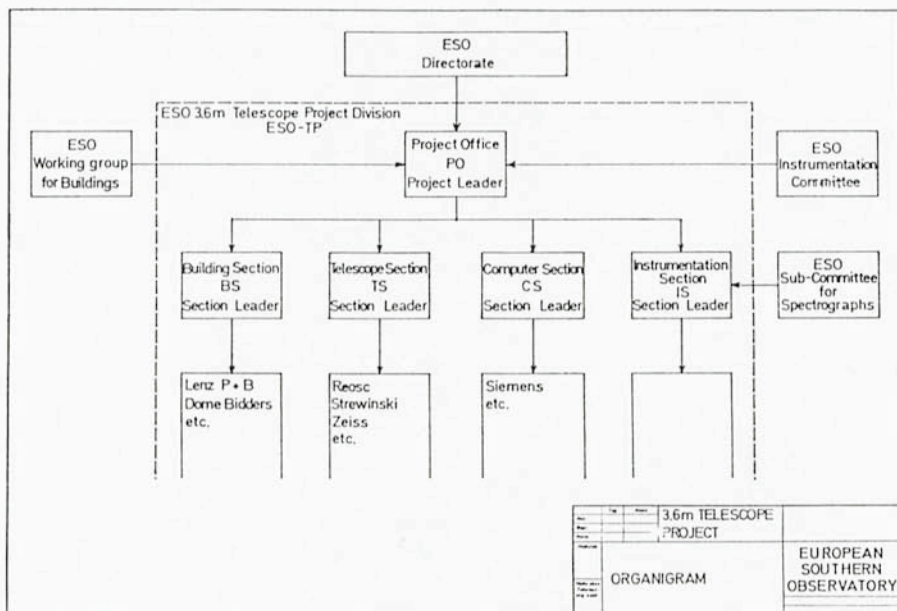

In May 1970, the ESO Directorate submitted to Council a proposal (Doc. Cou-66) for the structure, the constitution and the time schedule of an in-house group for the realization of the 3.6-m Telescope. It was endorsed by Council in its meeting of June 11, 1970, and provided the starting point for the execution of the project by the ESO TP Division in the next six years in collaboration with CERN. The two diagrams reproduced here from Cou-66 present the proposed administrative structure of the Group and the estimated time schedule for the period 1970-1976; the latter diagram illustrates the varying degree of involvement of engineers, technicians and astronomers and the shift of their activities from Europe to Chile towards the end of the period.

The various sections of the document dealt with Administrative Structure, Project Office, Building Section, Telescope Section, Computer Section, Instrumentation Section, Personnel Plan for Design Phase, and Long-Term Schedule and Personnel Plan. Throughout, there was reference to the possibility – but not necessity – that the group might be established at CERN, and the document was inspired by consultations with staff of CERN.

Starting point for the planning was the situation at the end of 1969, laid down in Ramberg's Status Report Cou-59. Making optimal use of what had



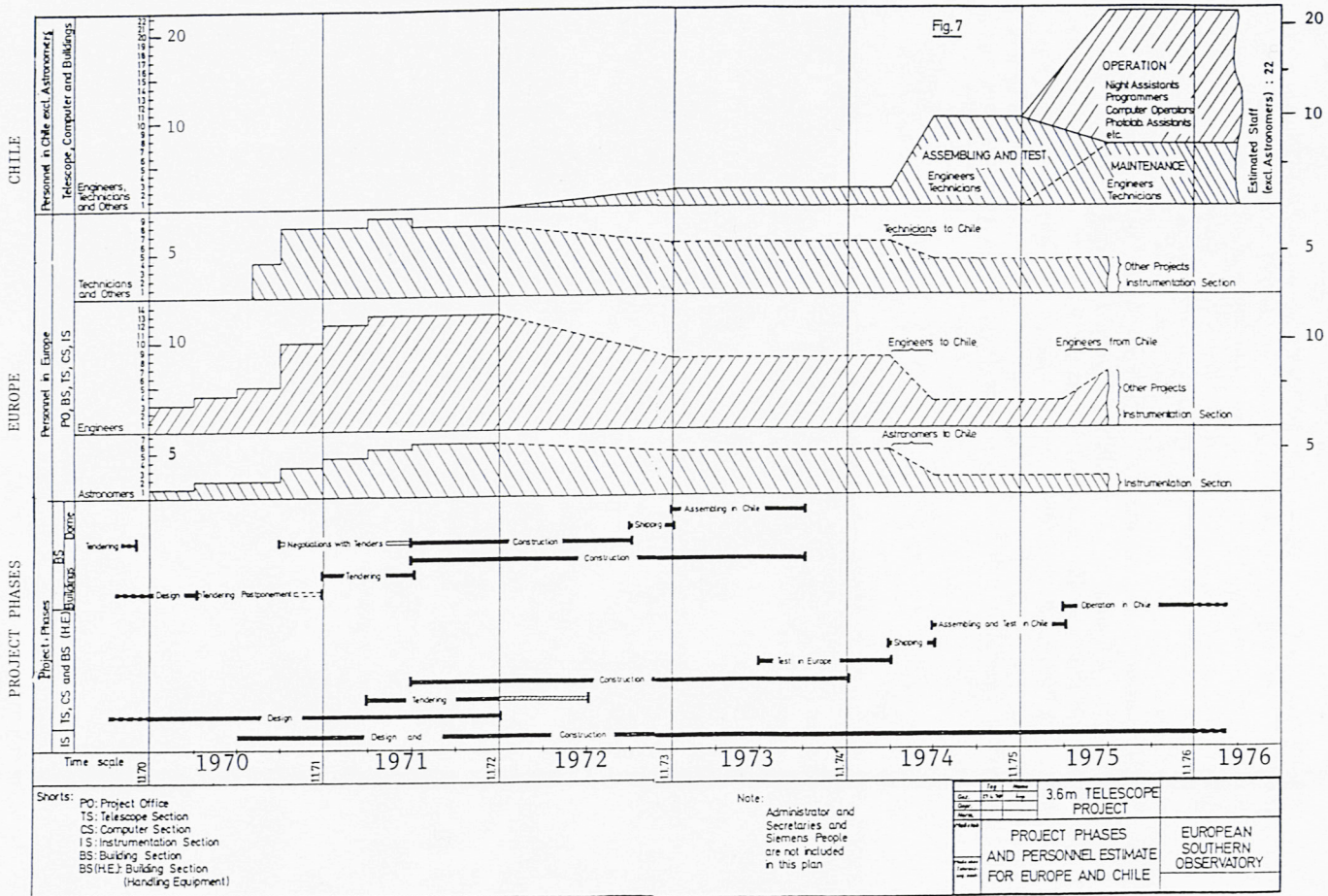



*The southern part of La Silla, early 1970. At that time, the intermediate-size telescopes were in regular operation; of these, we show here, at left, the 1-m Photometric Telescope and next the Grand Prism Objectif (GPO). Next to this, in the background, the dome of the Schmidt telescope, at that moment still waiting for the telescope's arrival (this happened at the end of 1971). In the far background, beyond the hill with the water tanks, the flattened summit prepared for the 3.6-m telescope. This one, however, would have to wait longer . . .; early 1970 was the time of the renewed planning of the realization of the telescope.*

*This photograph is one of a set taken for the firm of Hochtief that constructed the buildings of the first construction phase on La Silla and the Headquarters in Santiago. These photographs together with rather detailed descriptions of the buildings have been published in the July 1971 issue of the magazin Hochtief Nachrichten (in EHA-I.C.3.2.).*

been done so far on the project was a natural point of departure, although this was hampered by reluctance of Strewinski's bureau to provide documentation beyond the design drawings already delivered to the Instrumentation Committee. The long-term time schedule foresaw completion of building and dome on La Silla by October 1973, completion of assembling and testing of the telescope on La Silla around April 1975, and hence first operations in the course of that year.

No financial schedule was given, but much attention was paid to the detailed personnel planning which should be one of the principal bases for budget planning. For astronomical and technical staff – but not including administrative and secretarial help – the following personnel complements were foreseen: per January 1971, 24.5; per July 1971, 29; per January 1972, 27; and approximately that same level for the following years. At the time of submission of the report, Laustsen's group counted 5.5 members. The steep growth to some 25 or 30 members represented what had been expected from comparisons with large telescope projects elsewhere; it also underlined one of the serious shortcomings of the previous arrangement: the shortage of staff of the bureau of Strewinski. The personnel development plan given in Cou-66 is reproduced here in the accompanying diagram.

For the sake of comparison with projects elsewhere of comparable scope, Council was also presented with data obtained from AURA's Large Telescope Division, from the large radio telescope projects of the Max Planck Foundation at Bonn and of the Westerbork Project, and of the large optical telescope project of the Max Planck Foundation at Heidelberg.

### **First ESO Committee of Council Meeting, May 6, 1970**

On May 6, 1970 the ESO Committee of Council held its first meeting. As mentioned before, it had been created – following CERN practice – for discussing informally in advance of Council meetings items requiring consultation between ESO management and governments, or between the government delegates mutually, and it thus would help avoiding controversial situations at the Council meetings. Annexes 5b and 4 show the meetings of Council, Committee of Council and Finance Committee, and those of the Instrumentation Committee for the years 1970–74. Committee of Council consisted of the Council President and the Presidents of the IC, the FC and SPC, plus one Council member of those states not represented among these. It proved to be a very useful instrument; its meetings were held sufficiently in advance of the Council meetings that in the intervening period also advice from the IC or FC could be obtained. The proposal for collaboration with CERN was typically one to benefit from such preparatory activity.

Basic documents for this meeting were Cou-66 mentioned before, and a draft contract with CERN that meanwhile had been prepared by the adminis-

IX. THE 3.6-M TP DIVISION



*On September 16, 1970 at CERN, the contract was signed between ESO and CERN for collaboration in the realization of the ESO 3.6-m Telescope and its auxiliary equipment. The two photographs show, from left to right: J.H. Bannier, President of the ESO Council, B.P. Gregory, Director General of CERN; and G. Hampton, Head of Administration of CERN, A. Blaauw, Director General of ESO, and E. Amaldi, President of the CERN Council.*

*From photographs in the EHPA.*



***ESO's establishments on the premises of CERN.***

*By the end of 1970, a few months after the collaborative agreement between ESO and CERN had been signed, the Telescope Division had established itself in the building made available by CERN and marked in the above photograph by TP. The photograph shows the extensive complex of CERN's laboratories, technical facilities and administrative services, located at Meyrin near Geneva as they were in 1970.*

*A few years later, as will be described in the next chapter, ESO's Sky Atlas Laboratory also was established on the CERN premises; it was housed in the building marked SA, facing the TP Division.*

*From photograph in the EHPA.*

trative departments and legal advisors of the two organizations. Nucleus of the draft contract – based on the assumption of establishment of the Telescope Group on the CERN premises – were the services to be rendered by CERN: administrative, technical and professional. The Committee of Council meeting decided to submit a somewhat amended draft to the ESO Council, to be supplemented with the advice of the IC, the FC, and the SPC. Alternative solutions by collaboration with major industrial firms, like MAN, had meanwhile been further explored, mainly by Ramberg, but it



turned out that these firms were at best interested in realizing the construction of the telescope once the project would be well defined – and not in participating in the design work.

### **Council Resolves to Collaborate with CERN**

The Instrumentation Committee in its meeting of June 2, 1970 following that of the Committee of Council, after first endorsing the establishment of the Telescope Group as described in Cou-66, strongly supported the prop-



On December 31, 1971, Jöran Ramberg resigned as Technical Director after having been associated with ESO since November 1963 and having essentially contributed to its building programme and to putting the 3.6-m Telescope Project on the new track. These photographs, taken at his farewell party, show:

**upper left:** Jöran Ramberg, Mrs. Bloemkolk, and Johan Bloemkolk (Head of Administration).

**upper right:** Mrs. Ramberg, Jöran Ramberg, and Mrs. Bloemkolk.

**lower left:** H.W. Marek (accountant), Mrs. Bachmann, G. Bachmann (Head of Finance), Mrs. Behr, and A. Behr (consultant astronomer).

Photographs from EHPA.

osed collaboration with CERN. The FC, in its meeting of May 22, had remained faced with uncertainty as to the financial implications, but this was inherent to a situation in which reliable cost estimates could be obtained only after the telescope group would have started its work.

The Chairman of the SPC, Strömgren, was prevented from attending the forthcoming Council meeting, but provided the Council President with a written statement of June 4 along the lines of his advice expressed verbally at Committee of Council. The following passages are quoted from this letter:

*"I wish to emphasize the urgency of the situation regarding the construction of the 3.6-m telescope, and the necessity of reaching a decision soon on the questions of the Telescope Development Group as well as the agreement*

with CERN ---. I must emphasize the difficulty of the ESO situation: We do concentrate on the 3.6-m telescope, but we do not now consider the proposals that were made by the SPC to supplement the instruments already agreed on with instruments for other purposes, of intermediate size. Therefore, the way it looks is that during the period when ESO is constructing the 3.6-m telescope, there will be at the disposal of the whole ESO community of astronomers only the 152 cm and the 100 cm Telescopes, some smaller telescopes, and the Schmidt Telescope. ---. The conclusion is, that any further delay that would lengthen the lead-time – indeed any postponement regarding the 3.6-m Telescope – would endanger the future of ESO. ---” [8].

At the Council meeting of June 11, 1970, consensus of opinion was definitely in favour of both, creating the Telescope Development Group and collaboration with CERN, and Council accordingly resolved to submit a corresponding request to the Council of CERN. This met one week later, on June 18 and 19, and agreed to enter into the collaboration.

### **September 16, 1970: the ESO-CERN Agreement Signed**

The contract between the two organizations was signed on September 16 at CERN by the Directors General, Gregory and Blaauw.

Let me quote a few parts from the 21 articles of the contract:

from art. 2.1.a: *“toute la connaissance et l’expérience scientifique acquises par l’une des parties au présent Accord, et susceptibles d’affecter le travail de l’autre, seront librement communiquées et lesdites Organisations mettront à la disposition l’une de l’autre des solutions et méthodes utilisées dans les techniques de pointe de leurs domaines respectifs;”*

from art. 3.2: *“La responsabilité scientifique et technique du projet incombe entièrement à l’ESO, tandis qu’il incombe au CERN de fournir les installations et les services, dans toute la mesure du possible et dans la limite des moyens existant au Laboratoire du CERN.”*

from art. 4.1.b: *“--- le CERN fournit, dans des limites à convenir entre le CERN et l’ESO, les services administratifs nécessaires à l’exécution du projet sur le domaine du CERN, y compris les services des Divisions des Finances et du Personnel, ceux de la Division des Services techniques et Bâtiments qui ont trait à l’exploitation et à l’entretien du domaine et des bâtiments qui s’y trouvent, les services de transport habituels, les services de sécurité du travail et l’utilisation d’installations de caractère général, telles que les cantines, salles de conférence et bibliothèques;”*

from art. 10.1: *“L’ESO nomme un Chef de la Division ESO-TP, dont l’autorité et les compétences, notamment en matière de décisions financières, sont comparables à celles d’un Chef de Division du CERN.”*



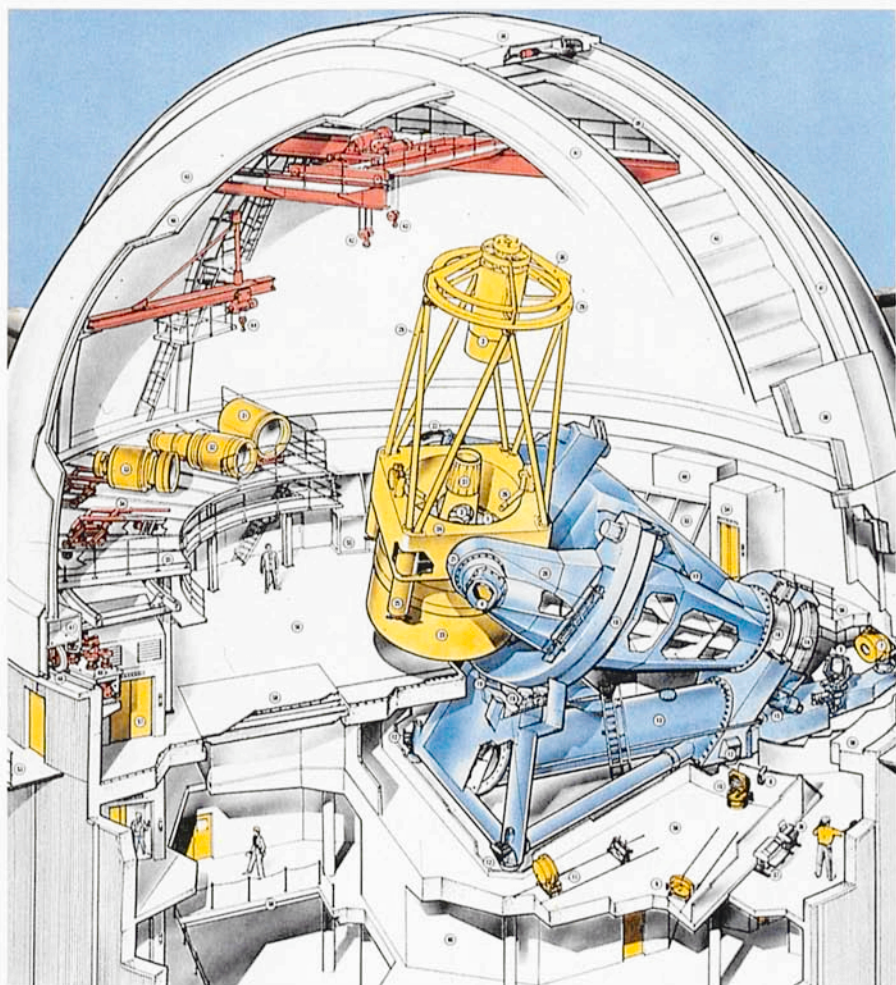

*Once the work of the TP Division was well under way, the expected appearance of the telescope-to-be was presented in a colourful poster. A black-and-white reproduction of the poster, designed by Tony Lofthouse in 1973, appeared in the ESO Annual Report of 1974. The section reproduced here shows the main features of the telescope, the design reflecting the early ideas of Strewinski described in the previous chapter.*



***TP Division on La Silla.** As the work of the TP Division progressed, more and more of its activity shifted to Chile. On this photograph, taken on La Silla on 23 October 1973, are from left to right: Reinaldo Kenneth, Secretary of the Division, Serge Petri, Henri Laporte (CERN), Emil Leroy, Mario Danesin, Jacques Rouel (CERN) and Svend Laustsen.*

*From photograph in EHPA.*

Already a month later, in October 1970, the small group of Laustsen – who was appointed to this post of Division Head – and collaborators moved to Geneva and started setting up the Telescope Project Division in a building made available by CERN on its premises. By the end of 1970, the group consisted of 12 people, six of whom were ESO employees. The TP Division was ready to realize the most important one of the instruments for which ESO had been created, the 3.6-m Telescope.

## **A Few Further Milestones**

Whereas a detailed account on the further developments would be beyond the present historian's task, mentioning of a few milestones in the further work of the TP Division seems in order here.

By February 1971 the TP Division had drawn up a new project description, an estimate of the financial implications, and a time schedule for its realization. By the end of 1971 the staff strength of the Division had grown to a total of 22, of whom 13 were ESO staff, 6 CERN staff and 3 belonged to agencies. A drastic decision had been taken in the course of that year, when it was deemed desirable to abandon the original design for the rectangular telescope building and to start from scratch for one adapted to new ideas developed through the IC, in spite of the considerable investments that had been made for the early design.

By the end of 1972 the Division was in a position to award contracts for the major construction programmes – the building, the dome, and the main structure and main gears for the telescope. The staff complement had risen to a total of 29, of whom 17 ESO staff and 6 CERN staff. The year 1973 saw the first assignment of TP Division staff on La Silla for setting up the building site. At the end of that year the staff strength had risen to 40 of whom 30 ESO and CERN staff, and by the end of 1974 still farther, including 36 from ESO and CERN. For the telescope the main substructures had then been completed and tested at the manufacturer; the concrete structure of the telescope building was virtually finished.

The year 1975 saw further shifting of staff from Europe to La Silla and the erection of the dome, and in Europe the successful conclusion of the testing of the telescope with its optics. The mechanical assembly of the telescope on La Silla was completed about August 1976, and finally, in the night of 7 to 8 November 1976 the telescope saw "first light": its first actual performance by presenting astronomers and technicians with a stellar image in the prime focus. This happened six years and seven weeks after the signing of the contract with CERN. The TP Division had marvelously stuck to the time schedule drafted early 1970.



## **X. THE SCHMIDT TELESCOPE: Design, Construction, the ESO-SRC Agreement and the Onset of Survey Projects**

*„Erlaube mir die Anfrage, ob ihr vielleicht für Spiegelteleskope interessieren, ich --- [möchte] mal sehen, was sich mit einem Spiegel fotografieren lässt, ---“*

From a letter of Bernhard Schmidt to Karl Schwarzschild of May 29, 1904 as quoted in *Abhandlungen Hamburger Sternwarte Band X, Heft 2*, p. 50.

As the last, but by no means the least, of the instruments of ESO's initial programme we turn to the Schmidt telescope. We review its history up to the time in the early 1970's when it began fulfilling its great mission: providing the astronomical community with the southern complement to the Palomar Sky Atlas. But first, a glance at its pre-history is in order.

### **Bernhard Schmidt and Early Developments at Hamburg Observatory**

From the beginning, the planning of the Schmidt telescope was, beside the involvement of the Instrumentation Committee, very much a concern of ESO's Director Otto Heckmann himself. In the early 1950's, the Hamburg Observatory had obtained a Schmidt telescope in the acquisition of which Heckmann had been deeply involved. This observatory had special affinity to this type of telescope because it was here that Bernhard Schmidt's invention had been applied first, and thereupon it had deeply affected observational astronomy. Let me, therefore, spend a few lines on these early developments [1].

At the commemoration of Schmidt's hundredth anniversary in 1979, the President of the University of Hamburg in his opening address related that in 1904 Bernhard Schmidt approached the famous astronomer Karl Schwarzschild with the question whether his work in optics might be of interest for Potsdam Observatory and that he much impressed Schwarzschild – and that in 1916 Schmidt contacted the Director of Hamburg Observatory, R. Schorr [2]. Schmidt's ingenuity in optics led to continued association with

## X. THE SCHMIDT TELESCOPE

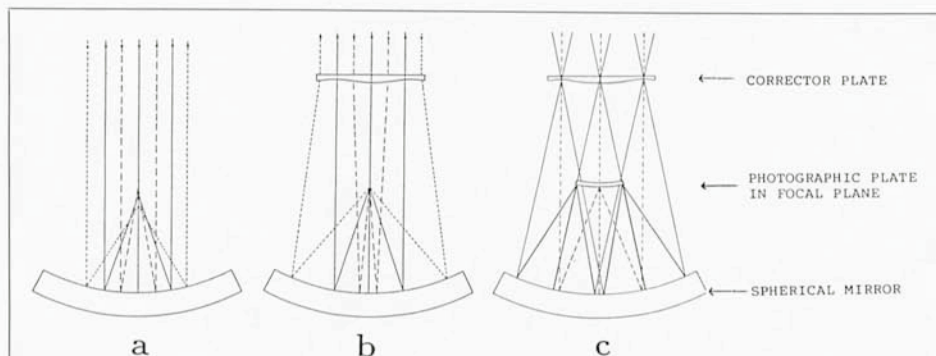

Schmidt telescopes allow astronomers to photograph large regions of the sky on one photographic plate and are therefore very suitable for making sky atlases. The sketches in this box illustrate the main optical features of the Schmidt design.

A basic element is the *spherically* shaped primary mirror, contrary to the *parabolic* mirror of regular telescopes like the ESO 3.6-m telescope. Figure *a* shows how this spherical mirror would work if it would receive a beam of the star light. There would be no unique focal point: marginal light rays focus on a point closer to the mirror than rays hitting the mirror nearer to its centre. This difference is eliminated by letting the light pass through a specially figured glass plate, the corrector plate, the centre of which is placed in the centre of curvature of the primary mirror, see Figure *b*. Given the presence of this corrector plate, we may now let the telescope receive light from stars that are at large angular distance from the central axis of the system: as shown in Figure *c* these rays will be focussed in essentially the same way and at the same distance from the mirror, on a spherical surface that also has its centre of curvature at the centre of the corrector plate.

Some sensitivity of the optical system to the wavelength (colour) of the infalling beam arises from the slight refraction of the light when it passes through the corrector plate. Shape and material of the corrector plate must therefore be chosen in accordance with the wavelength region of the planned survey.

As the focal plane is curved, the photographic plates are forced to have the same curvature by placing them in specially designed plate holders, a treatment that most of the (thin) plates survive.

this observatory under Schorr's direction and encouragement, and in 1931 produced the first instrument of the type we now call "Schmidt Telescope". In the *Messenger* of June 1979, Alfred Behr commemorated Bernhard Schmidt's achievements and showed a picture of the original Schmidt telescope, still at Hamburg Observatory. For the benefit of those readers who are not acquainted with the special properties of this type of telescope, the accompanying box describes its main optical features.

Considerable stimulus for Schmidt's work also seems to have been due to Walter Baade who was a member of the staff of Hamburg Observatory from 1920 to 1931. Schmidt died in 1935, and when in 1936 Baade was nominated for the succession of Schorr as Director, he made it a condition that the Observatory should be equipped with a Schmidt telescope of 80 cm aperture. The Hamburg authorities agreed, and notwithstanding the fact that Baade ultimately preferred to stay at Mt. Wilson Observatory with the prospect of utilizing the more powerful 120-cm Palomar Schmidt, the plans for the Hamburg Schmidt were realized [3]. It was to have a focal length of 240 cm, and a 120 cm diameter spherical primary mirror. In this realization Heckmann played a leading role.

It is no surprise, then, that Heckmann felt that the acquisition of the ESO Schmidt should be very much a matter of his interest and responsibility. Along with the essentially French realization of the 1.5-m telescope, the Dutch one of the 1-m telescope (both described in chapter IV), and the Danish role in the development of the Telescope Project Division (described in chapters VIII and IX), the Schmidt-telescope project may be considered as the early major instrumental contribution from German side.

### **Planning the ESO Schmidt**

At the meeting which marked ESO's beginning, June 21, 1953, Baade suggested that ESO should acquire a copy of the Palomar Schmidt, and thus would be able to soon start its work. The Palomar Schmidt with its 120 cm aperture, fully operational since 1949, certainly met its designer's high expectation for wide-field photography. However, ESO astronomers wanted more: the facility to obtain objective prism spectra. In the 1950's, spectral surveys played an important role in galactic research at many European observatories and it was important to extend these to fainter stars than had been reached so far.

This point was raised for the first time by Heckmann at the July 1958 meeting of the ESO Committee, and taken up again when in November 1961 the Committee requested the recently created Instrumentation Committee to consider an alternative design. This differed from the Palomar Schmidt mainly in that the aperture would be 100 cm – 40 inch – instead of 120 cm, and the diameter of the spherical mirror 160 cm instead of 180 cm, however maintaining the focal length (305 cm) of the Palomar Schmidt and hence its plate scale (approximately 67" per mm). Reason for this modification were the reduced size, and hence the lower weight, of the objective prism and therefore a considerable reduction of the demand on the sturdiness of the telescope tube and lower costs, and an important additional consideration was the smaller chromatic variation that is left after the correcting plate's

## X. THE SCHMIDT TELESCOPE

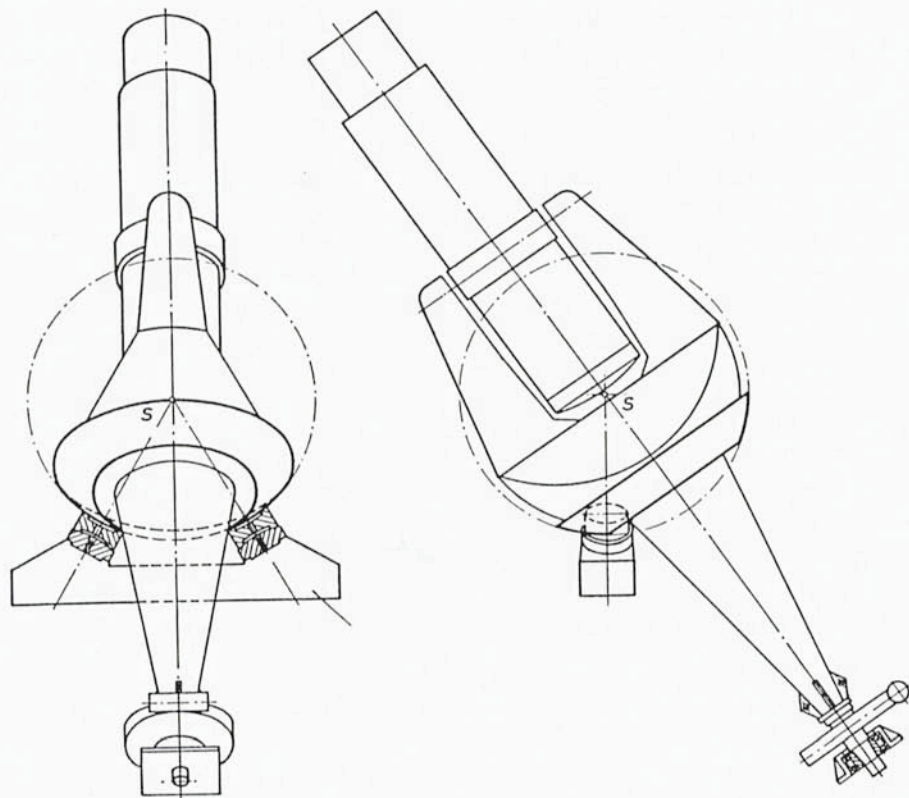

*The Hamburg Schmidt Telescope: two drawings by W. Strewinski occurring in his article quoted in the text [18] and showing design features also adopted for the ESO Schmidt.*

elimination of the principal part of the spherical aberration, allowing high quality objective prism spectra over a wide range of wavelengths [4]. The Hamburg Schmidt also had been provided with an objective prism.

In October 1962 the IC, upon advice from various experts, endorsed the proposal and the EC in its meeting later that year decided accordingly. A disadvantage was the reduced size of the vignetting-free field, only  $5^{\circ}.4 \times 5^{\circ}.4$ , corresponding to the standard plate size of  $30 \times 30$  cm, instead of the  $6^{\circ}.5 \times 6^{\circ}.5$  of the Palomar Schmidt (due to the fact that the focal length was not reduced in the same ratio as the dimensions of correcting plate and mirror), and the consequent increase of the number of plates required for



covering the sky in the survey programmes. However, this was accepted. This deviation from the specification of the Schmidt in the ESO Convention was confirmed at the first meeting of Council in February 1964.

### **Mechanical Engineer and Manufacturer**

The Hamburg Schmidt had performed satisfactorily since its dedication in the year 1954, and so it was natural for Heckmann to propose to the IC to put the realization of the mechanical parts of the ESO Schmidt in the hands of those who had been responsible for the Hamburg telescope: the firm of Heidenreich and Harbeck (precision steel constructions) at Hamburg – henceforth denoted by H&H – in collaboration with the mechanical engineer W. Strewinski. Strewinski had been an employee of H&H, but after the completion of the Hamburg Schmidt created his own, independent, engineering bureau.

On the other hand, as described in chapter IV, the ESO Committee that in the early days managed the affairs, preferred the creation of an engineering group to be charged with the comprehensive task of developing all major instrumentation, including the 3.6-m and the Schmidt telescopes. A preliminary agreement for a joint venture of this nature was reached with the engineers Strewinski and Hooghoudt in November 1961 [5] and contracts were signed by them in August and September 1963, respectively [6]. To what extent these covered more than just the Schmidt telescope is not clear, but in any case the arrangement did not work out satisfactorily. In August 1963 there still was a prospect for joint effort in the design of the Schmidt [7], but in February 1964 all the ESO Directorate had at its disposal were some preliminary studies by Strewinski. Hooghoudt (whose involvement in the 1-m telescope was described in chapter IV) had become heavily involved in the Benelux Cross Antenna Project, a – not realized – precursor-proposal for the Westerbork Synthesis Radio Telescope.

Heckmann then decided to refrain from the joint proposition, and by the middle of 1964 proposed to IC and Council to proceed for the Schmidt exclusively with Strewinski [8]. Council agreed, although reluctantly, as it foresaw delays in view of Strewinski's simultaneous involvement in the work on the 3.6-m telescope. In June 1965, Heckmann informed Council that a draft contract with Strewinski had been drawn up. One of his first tasks was the design of the mirror cell, the mirror itself nearing completion, in 1967, at Zeiss-Oberkochen.

### Some Design Features

Contrary to what has been done for the smaller ESO telescopes, no comprehensive description of the design has been published for the Schmidt. A brief description by Heckmann occurs in the report on the 1972 Conference on Schmidt telescopes [9]. Specifications also occur in R. West's article on the Sky Survey project in *ESO Bulletin* No. 10 of May 1974, and later modifications have been described by A. B. Muller, see Note [16]. Quite instructive are also the proceedings of the IC meetings over the years from 1962 on. Some of the main features of the telescope are described in the following paragraph.

As in the case of the Hamburg Schmidt, a fork mounting has been chosen, and the weights of all movable parts (tube plus polar axis) are distributed in such a way that their centre of gravity coincides with the centre of the sphere which also defines the surface of the oil pads along which the upper bearing slides during its motion when the telescope is set on, or follows, a star. As one of the advantages to this construction, it allows smooth adjustment of the polar axis. The mirror is supported in its cell in such a manner, that it allows maintaining exact focussing – so essential for Schmidt photography – by means of invar rods, free of thermal expansion, which keep the plate holder at constant distance from the mirror. Stiffness of the telescope tube is achieved by a double-wall construction, and an outer layer of thermal insulation helps avoiding rapid temperature changes of the interior.

### A Daring Design, Not Realized

In the early 1960's, as an alternative to copying the design of the Hamburg Schmidt, Strewinski suggested for further study a rather unorthodox one, referred to as the "spherical model". It went a step farther in that not only the surface of the upper bearing that is in contact with the pads of the mounting is spherically shaped, but this spherical section is extended so as to become an almost complete sphere to which the telescope tube is directly fixed.

Fork prongs and declination axis are dispensed with. The axis of the telescope tube goes through the centre of the sphere, which is also made the centre of gravity of the sphere together with the tube including its optics. There is a short polar axis with bowl-shaped upper end to which the sphere can be clamped by means of electro-magnets fixed to the bowl. For motion around the direction towards the pole, all clamps are fixed. For adjustment in declination, two of the clamps are switched off, and the third one remains clamped but it can be displaced along a slide [10]. The concept is sketched in a drawing reproduced by Ch. Fehrenbach in his recent monograph "Des hommes, des télescopes, des étoiles" [11].

As advantages of this model, Strewinski pointed out that only a short and relatively light polar axis is needed, that the spherical mounting is very rigid and quite resistive against earthquakes, and that the foundation of the mounting would be simple and cheap. Manufacturing would present no difficulties and not be expensive.

The spherical model was discussed by the IC in the meetings of March, June and September 1964. The majority of its members, although appreciative of the new concept, was hesitant about applying it in the case of the ESO Schmidt. Heckmann was in favour of pursuing the idea, and reported at the September meeting that also Bruce Rule of Palomar Observatory, after a meeting in Strewinski's office, had expressed himself positively. Yet, the idea was not followed up any further, and Strewinski agreed to follow in his design essentially that of the Hamburg Schmidt.

## **The Optics**

Following a recommendation of the IC, the ESO Committee in its meeting of February 1963 decided to order the spherical mirror with diameter 1.62 m from Schott, Mainz, to be made of low-expansion Duran 50 glass, and from the same firm the 1-m corrector plate, to be made of ultraviolet-transparent Schott UK-50. The orders were finalized right after the ratification of the Convention. Figuring was done by Zeiss-Oberkochen, where mirror blank and corrector plate arrived by the middle of 1965 and early 1966, respectively [12]. A mishap occurred when, by unknown cause, the blank broke in the early figuring phase, but it was soon replaced so that no delay was caused. In the course of 1967 both mirror and corrector plate approached their final shape and would soon be ready for testing in the mirror cell. Unfortunately, construction of the cell and its related mechanical parts was not yet completed at that time. Provisional acceptance took place in October 1970 upon examination by Ramberg and Alfred Behr, expert in optics of Göttingen Observatory (who also made the polarimeter for the 1-m telescope). Meanwhile, also in 1967, material for the first, 4° objective prism of UBK-7 had been ordered from Schott, to be shaped by Zeiss-Oberkochen.

## **Mechanical Construction and First Tests**

Negotiations with the firm of Heidenreich and Harbeck started in the first half of 1967 and the contract for the construction of the mechanical parts was concluded later that year. The minutes of the July 1968 Council meeting report that manufacturing had started and – optimistically! – “*A preliminary assembling – – – at the factory will be possible in October. According to the plan the definitive assembling of the telescope in its building on La Silla will start in February or March 1969.*” However, it was only at the December

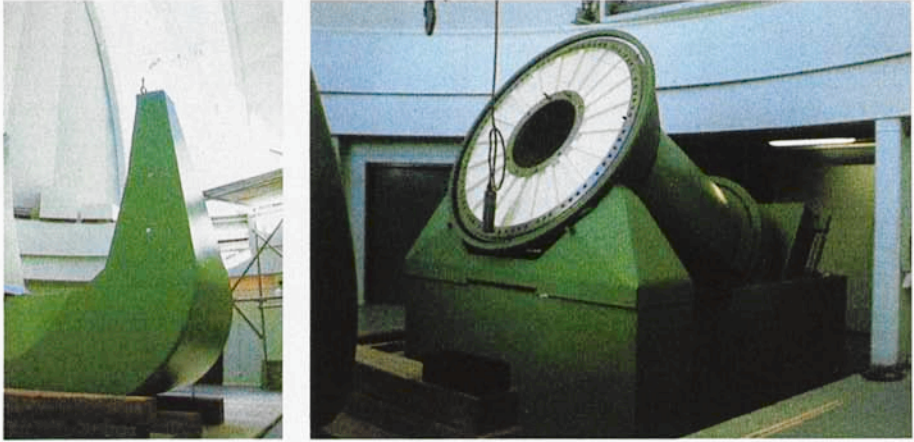

***Mounting the Schmidt Telescope in the fall of 1971.***

*The photograph on the left shows the massive fork that would carry the telescope tube, resting on the floor of the dome. The right-hand photograph shows the polar axis already placed on its bearings. Soon after these photographs were taken, the bottom part of the fork was bolted on the flat top section of the polar axis. Photographs by Eric Maurice in the EHPA.*

1968 meeting that the Directorate could report that Strewinski had finished nearly all drawings for H&H. Unfortunately, changing economic conditions in the German Federal Republic by that time caused H&H to become less interested in spending their efforts on the Schmidt and to give preference to more rewarding orders, and Council – rather superfluously . . . – urged Heckmann to put strong pressure on the firm [13].

Such, then, was the situation at the time of the dedication ceremonies on La Silla in March 1969 – a time also, however, of growing discontent among Council because of the lack of progress in the Large telescope and Schmidt projects. By the end of that year, according to the Annual Report, contrary to expectations of one year earlier, the drawings of the mechanical parts were not yet completely available. Even at the end of 1970, partly due to illness of Strewinski, delivery of the telescope mounting was still retarded, and it was

only in 1971 that the telescope was mounted at H&H for first tests. By the end of the year it arrived on La Silla and was assembled in "its" dome where, three years earlier, dignitaries and guests of ESO had gathered for the dedications. Final testing of the combined mechanical and optical parts could now be taken up.

After his retirement as Director General per 1 January 1970, Heckmann acted as consultant to ESO, as agreed at the Council meeting of December 1969. This concerned first of all the commissioning of the Schmidt. He was present on La Silla for prolonged stays, usually together with Strewinski and Technical Director Ramberg. After having witnessed the first satisfactory optical performances of the telescope, he returned to Europe at the end of February 1972. He would not return to La Silla again.

### **Heckmann's Concern in Retrospect**

With the termination of Heckmann's consultantship in 1972 and Ramberg's retirement from ESO at the end of 1971 came the conclusion of the first stage in the Schmidt's development. By that time satisfactory photographic plates could be obtained, yet many finishing touches remained to be applied before the instrument would acquire the mature status required for the highly demanding Sky Survey programmes. A new team took over in the course of 1972 of which the achievements will be sketched below. However, let me first insert a few comments on the past, troublesome, period.

For Otto Heckmann, who had identified himself so strongly with the project, bringing it to satisfactory completion had been a matter of deep concern. Worry and disappointment were caused by the failure of the engineering bureau to satisfy the high expectations he had in the beginning. His strong belief in Strewinski's qualities as an engineer made Heckmann accept the burden of Strewinski's increasingly irrational and complicated reactions. This burden grew in the course of the years when, on the one hand, Strewinski, notwithstanding the broadening scope of his assignment, persisted in remaining involved in minute details of the design whereas, on the other hand, he became more and more suspicious and distrustful and lesser and lesser communicative. As far as the author is aware – and this extends into the period of my General Directorship of ESO – Strewinski has consistently refused to sign a contract for work to be undertaken, simply referring to his honesty and professional pride.

Much of this seems to be related to Strewinski's having spent years as a war prisoner in the USSR during and after World War II, where his engineering qualities and ingenuity seem to have been thoroughly exploited, even leading to continued captivity notwithstanding promises of release. He returned to Germany in 1949. Heckmann, in his book *Sterne, Kosmos, Weltmodelle*,

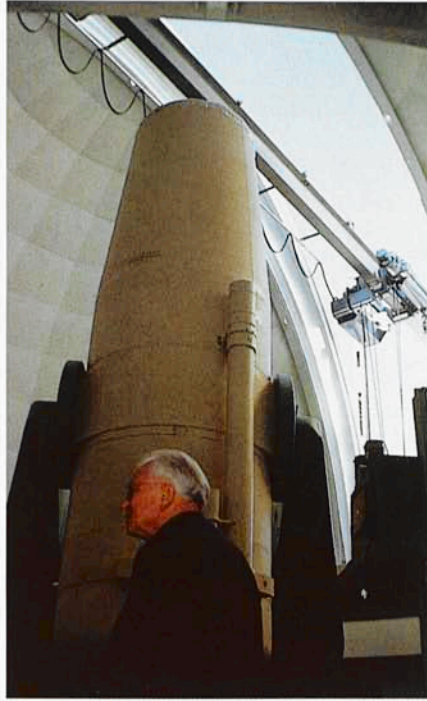

**December 21, 1971.** *Otto Heckmann in front of the Schmidt telescope during its first test period.*

*Photograph by Eric Maurice in the EHPA.*

refers at several places to their collaboration [14]. Among these references is the following, after Heckmann's mentioning Strewinski's early work on the Hamburg Schmidt: *“Ein Jahrzehnt später stand er uns als selbständiger Ingenieur gegenüber. Leider hatten wir erst zu einem Zeitpunkt, als seine Arbeiten bereits weit fortgeschritten waren, klar erkannt, wie starr und mißtrauisch er in der Zwischenzeit geworden war. --- Seine Unlust, sich auszusprechen oder gar zu fragen, führte leider mehrfach dazu, daß wir vor fertige Entscheidungen gestellt wurden, wo wir gerne mitbestimmt hätten. So kam es, daß später Schwierigkeiten auftauchten, weil manche Einzelheit zu geistreich, zu kompliziert gelöst worden war. ---”.*



*Otto Heckmann (23-6-1901 – 13-5-1983), painted by the artist Herbert von Krumhaar on the occasion of his retirement from the General Directorate per December 31, 1969. After his retirement, Heckmann continued to work for ESO as a consultant with particular attention to the completion of the Schmidt telescope. This consultancy was concluded when the first operational stage of the telescope had been reached in the course of 1972. The painting was donated by friends and colleagues of Heckmann.*

As far as the ESO Council is concerned, the body where the ultimate responsibility rested, we have described their growing impatience in previous articles. Looking back, we may be surprised by their leniency; confidence in Heckmann's judgement prevailed.

### **Steps Toward Perfection**

The first phase was followed by a lengthy period of finishing touches and improvements under the supervision of André Muller. Well qualified for the job by experience in optical instrumentation gathered early in his career, as well as by his acquaintance with La Silla, Muller embarked upon a series of technical improvements in collaboration with the staff on La Silla – particularly with Hans-Emil Schuster – and with the growing expertise of the staff of the TP Division, of which especially the important contributions of the engineer Jan van der Ven should be mentioned. In 1972 Muller stayed for several extended periods on La Silla where he collaborated in the middle of the year with Strewinski. The long series of improvements and modernizations which followed extended over many years, during the time of my Directorate and beyond. They will not, therefore, be recorded here in any detail – I shall only touch upon some main points, as a background for the account on the large observational projects summarized below, which developed parallel to this work.

Defects in the electronic control system as it had been delivered before the ESO TP Division became involved caused a major problem. Eventually, an entirely new system was installed, similar to the one developed by the TP Division for the 1-m telescope in 1974. Also, at the TP Division, entirely new mechanical drive systems in right ascension and declination were constructed.

A very important problem, encountered already in the beginning of the observational work, was that of the differential motion between the camera holding the plate holder and the field on the sky as seen by the guiding

#### ***The Schmidt Telescope in operation.***

**Top photograph:** Oscar Pizarro, who together with Guido Pizarro was responsible for carrying out most of the extensive and delicate programme of observations for the ESO Sky Surveys, guiding the telescope during an exposure.

**Bottom photograph:** placing the plateholder in the telescope.

*From undated slides in the EHPA.*



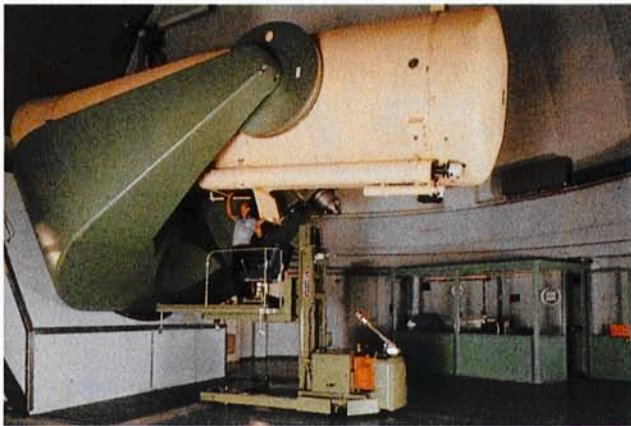
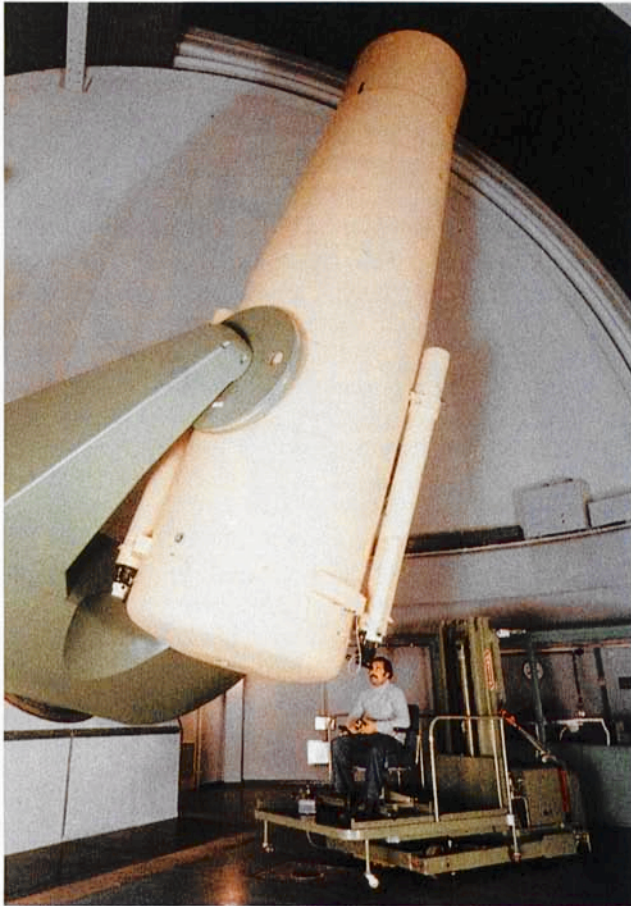

telescopes. The history of this problem goes back to the earliest work with Schmidt telescopes [15]. It became more and more pressing as the required exposure times became longer. For the ESO Schmidt, a major improvement was found by discarding altogether the use of guiding telescopes attached to the Schmidt tube, and introducing an offset guiding system that directly observes stars in the field of the Schmidt optics itself. And, when plates have to be taken with exposures of several hours, as is the case for the Sky Surveys, perfection even has to be carried so far that, by means of computer control, the variation in the relative position of the pointing of the plate centre with respect to that of the offset guider, caused by the changing differential refraction in the earth atmosphere, must be eliminated.

For a review of further improvements I refer to a contribution by Muller to the Bernhard Schmidt Centennial celebration mentioned before [16] and to a review by R. West "The ESO Sky Surveys" in IAU Colloquium No. 78 [17].

Finally, it is of interest to know that in 1958 Strewinski published a detailed description of the Hamburg Schmidt, which has much basic design in common with the ESO Schmidt. This work made him acquainted with the exactingness of astronomers: "*Die Wünsche der Astronomen bezüglich Genauigkeit und Zuverlässigkeit ihrer Instrumente sind sehr weitgehend. Es bedarf erheblicher Anstrengungen der Konstruktion und Fertigung – – um die gestellten Forderungen zu erfüllen*" [18].

### **The Sky Atlas Laboratory**

In the course of the year 1971, with completion of the Schmidt drawing nearer and the operational stage in sight, the next step to take was the creation of adequate facilities for processing the expected photographic material. The high optical performance to which the telescope was gradually brought, had to be matched by the highest possible perfection in the handling of the plates taken with the telescope. This became especially significant in connection with the planning of the sky atlas.

In the early days of the planning for ESO, the use of the Schmidt telescope for producing sky surveys did not yet figure very prominently in comparison to, for instance, objective prism spectral work. However, by the time the instrument became ready for use, observations for the Sky Atlas were seen as the most important task for the first years of operation. The Atlas produced by the Palomar Schmidt for the northern sky had proved to be of enormous importance for research in many fields, especially for identifying candidate objects to be observed with large telescopes. Providing the southern counterpart of the Palomar Atlas became the most urgent task for the ESO Schmidt.

The extraordinary demands the photographic processing technique has to satisfy can be appreciated if one realizes that a Schmidt plate may contain some million or more stellar images, mixed with images of faint galaxies and



***The ESO Sky Atlas Laboratory on the premises of CERN.***

*By Council decision of December 1971 ESO established its Sky Atlas Laboratory on the premises of CERN, close to the TP Division. Before the end of 1972 it was ready to start the wholesale production of the copies of sky photographs obtained with the Schmidt telescope.*

*The above photograph shows the laboratory's staff and visitors in March 1973. In clock-wise direction, starting from the lower left corner: Bernard Dumoulin; a visitor from TPD; Françoise Patard; another visitor from TPD; Bernard Pillet; Bill Miller from Pasadena; and Richard West.*

*Photograph by PHOTO CERN in the EHPA.*

diffuse nebulous objects, each of which may become the object of separate investigation now or in the future, and that not only all of these images should be of optimal quality, but that at the same time the plate should not contain any defect that might interfere with the research. Spurious stellar images due to inadequate processing must be avoided, and so must inhomogeneous development of the plates, scratches, etc.

Accordingly, two steps had to be taken: providing the dark room in the Schmidt telescope building on La Silla with up-to-date equipment for the

## X. THE SCHMIDT TELESCOPE

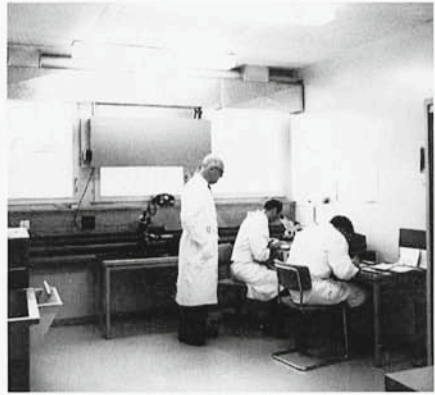
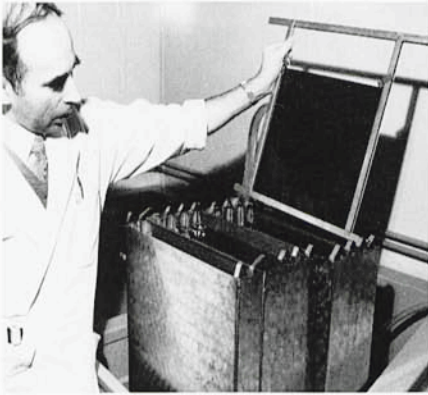

### **Working at the Atlas Laboratory, March 1973.**

**Left photograph.** B. Dumoulin inspects a  $30 \times 30$  cm copy glass plate. The special plate frames and tanks for fixing and washing were of his design.

**Right photograph:** William ("Bill") Miller of the Palomar Atlas Laboratory (Hale Observatories), from whose experience the ESO laboratory benefitted greatly, looking over the shoulders of B. Dumoulin and R. West.

Photographs by PHOTO CERN in the EHPA.

processing of the plates and for prints to be made from them, and the creation in Europe of an ESO photographic laboratory for the wholesale reproduction of these prints without loss of quality. These were challenging tasks, for mastering the required techniques could not be learned from experience collected in any laboratory, scientific or industrial, in Europe, and contracting out to industry would have been too expensive. It was, therefore, a most fortunate circumstance that ESO could profit from the know-how gathered by American colleagues involved in the Palomar Sky Atlas project. Readiness to fully share their experience with ESO was expressed at an early stage to the author by Rudolph Minkowski who supervised at that time the Atlas Laboratory at Pasadena.

Consultation within ESO in the middle of 1971 led to a proposal to the Council meeting of Nov. 30–Dec. 1 for the establishment of a laboratory equipped for the production of large numbers of copies of the Schmidt plates on film or on glass. It was a major proposition, considering the space required, the personnel to be appointed, and the equipment to be purchased; on the other hand, the work to be done was a natural follow up on the completion of the telescope.

Council agreed, including the decision to establish the installation, not at the site of the administrative headquarters in Bergedorf, but on the premises of CERN, close to the TP Division which at that time had just started its work. For this project, again, strong support was received from the side of the Directorate of CERN that created space in one of its buildings adjacent to the TP Division.

As leader of the project, Richard West was appointed who since January 1970 had been an ESO employee as scientific associate to the Director General. As one of his first moves, West took up contact with the Atlas Laboratory at Pasadena and laid the foundation for close collaboration with William ("Bill") C. Miller who directed this project. Over the years, Miller's active interest and support contributed much to the work of the ESO Laboratory.

### **The Quick Blue Survey**

Well within a year after the Council decision of December 1971, the Atlas Laboratory was ready for its first tasks. A major project was soon to be undertaken: the production of the ESO-B Atlas for which the first plates were taken in April 1973. It has also been referred to as the ESO "Quick Blue Atlas", a name derived from its aim to provide the astronomical community at an early date with an overall picture of the southern sky, pending the production of the more sophisticated ESO-SRC Atlas the origin of which will be described below. The Quick Blue Atlas was distributed on limited scale (see also below, under ESO/SRC Agreement), yet it soon played an important role in many research projects. It covered the sky between  $-90^\circ$  and  $-20^\circ$  declination by means of 606 fields with exposures of one hour, reaching a limiting blue magnitude of about 21.5.

Much of the successful achievement of the Atlas project (it was completed in 1978) must be attributed to the harmonious collaboration between the staff handling the Schmidt observations at La Silla including the delicate processing and making first copies, i. e. Hans-Emil Schuster and the brothers Guido and Oscar Pizarro, and the staff of the ESO Sky Atlas Laboratory.

### **A British Sister for the ESO Schmidt**

While ESO worked on the realization of its Schmidt project, a southern Schmidt also formed part of a project for two Schmidts to be acquired by Cerro Tololo and Kitt Peak Observatories around the year 1970. (In fact, as early as in 1960 a Schmidt for Tololo was under consideration [19].) Preliminary designs aimed at telescopes with an aperture of 1.3 m, a focal length of at least 4 m, and fields of  $4.4 \times 4.4$ . These telescopes should, moreover, be convertible to Cassegrain operation. Design considerations were presented



***The Atlas Laboratory's first exhibition.***

*In November 1973 the Atlas Laboratory organized an exhibition of its work and of that of the TP Division in the entrance hall of the Main Office Building of CERN. Between the first and the second sky photographs from the left is a model of the 3.6-m telescope building, containing a model of this telescope.*

by R. Buchroeder and B. Lynds at the 1972 Hamburg Conference referred to below, but the project did not materialize.

However, a sister for the ESO Schmidt was born elsewhere. Early 1971 the ESO Directorate learned about plans being developed for a southern Schmidt by the British Science Research Council (SRC) under the leadership of Vincent R. Reddish, Director of the Royal Observatory at Edinburgh. Based on a design closely similar to that of the Palomar Schmidt, this telescope became operational already in September 1973 – an outstanding achievement when compared to the tedious history of construction of the ESO Schmidt! A brief description of the SRC Schmidt – placed at Siding Spring Mountain in Australia where also the Anglo-Australian 3.5-m Telescope is located – was presented by Reddish at the Conference on Schmidt Telescopes in 1972 mentioned below.

Obviously, with the prospect of these two powerful Schmidts in the southern hemisphere, coordination of their programmes was in order. The ESO Directorate therefore approached Dr. Reddish and found him agreeable to joint planning, and this was soon followed by parallel consultation between the President of the ESO Council and the Chairman of the SRC. From these first steps, a very fruitful collaboration emerged.

### **The Hamburg Conference on Schmidt Telescopes**

A first result of this collaboration was the Conference on The Role of Schmidt Telescopes in Astronomy, held at Hamburg Observatory on March 21–23, 1972. This observatory joined in the organization of the conference, and the proceedings were edited by Ulrich Haug of Hamburg Observatory [20]. The conference surveyed fields of applications of large Schmidts, and in particular served for looking ahead in connection with the extensive Sky Surveys to be carried out in the coming years. It profited much from the participation of astronomers involved in the work with the Palomar Schmidt. On the day following the conference, March 24, a session of specialists discussed in detail the specifications for the surveys.

### **The ESO-SRC Agreement**

After the Hamburg Conference, consultation between ESO and the SRC gradually shaped the final agreement [21]. A first draft was made by Reddish in April 1972, and the final text was signed in January 1974 by Reddish as Project Officer of the U.K. 48-Schmidt Telescope Unit, and the ESO Director General. From ESO side the correspondence was conducted mostly by Richard West, whose task as Head of the Sky Atlas Laboratory henceforth would also embrace this collaborative project. The agreement has been of far-reaching importance for astronomical research. We shall outline here its main features. For a more detailed account reference is made to R.M. West's article on the ESO-SRC Sky Atlas and related items in *ESO Bulletin* No. 10 of May 1974, and to accounts in the ESO Annual Reports.

The agreement consisted of four parts. The first one defined a general framework for collaboration “– – considering that ESO and SRC have previously expressed their interest to cooperate in carrying out southern sky surveys and publishing the results, – – –”. The second part was an arrangement “governing the production, publication and sale of a two-color atlas of the southern sky”, to be printed on film. The third part concerned arrangements “governing the production and distribution of initial [glass] copies of the ESO (R) and the SRC (IIIaJ) surveys”. The fourth part dealt with “the production and distribution of initial copies of the ESO “B” Survey”.



**Two of the early photographs taken with the Schmidt telescope.**

**Left:** The central part of the constellation Orion including the Orion Nebula, a 20-minute exposure taken by Schuster on February 2, 1972.

**Right:** The Carina Nebula, a 45-minute exposure taken by Schuster on February 28, 1973.

In this fourth part, principal item was the number of copies of the Quick Blue Survey to be distributed by ESO among ESO countries and a few US observatories and by SRC among observatories in the UK (and the price to be paid for the latter by SRC). 20 glass copies and 20 film copies were to be made, of which SRC acquired 6 on glass and 14 on film. Taking the plates for the Quick Blue Survey had started in April 1973. By the end of 1973, 40 acceptable plates (out of 80 taken) were available. We note that the earliest



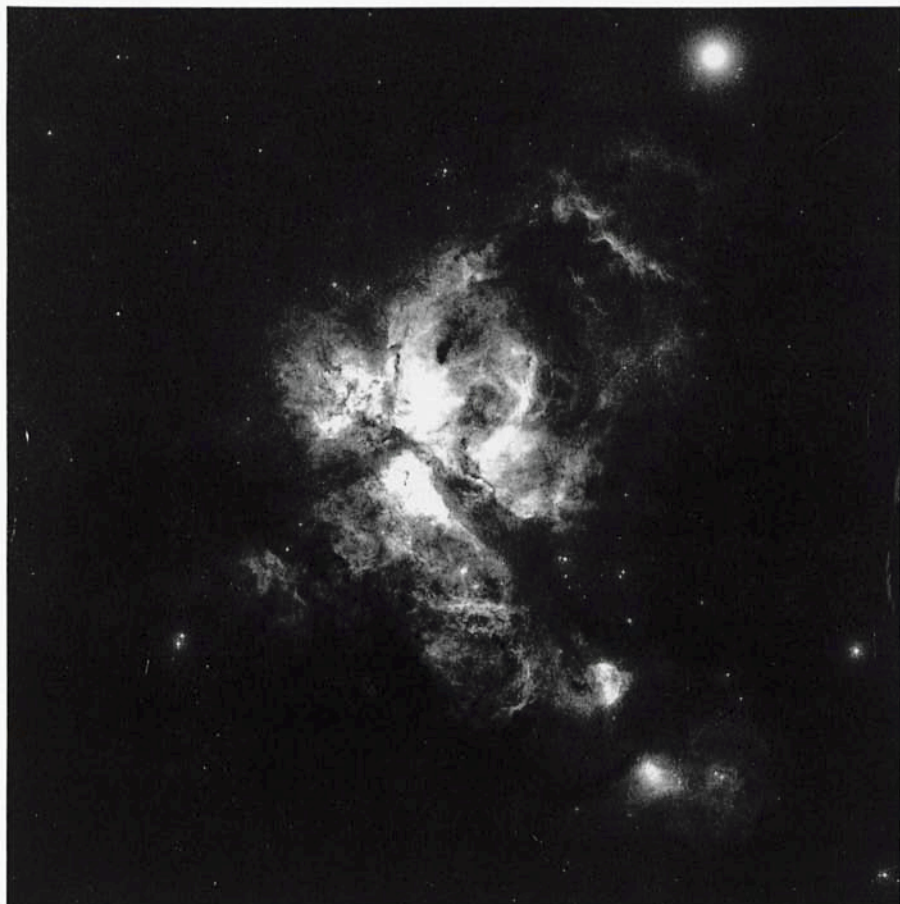

plate used for this survey carries the number 299 [22]; plates taken previously served many other purposes.

The second part specified the most substantial component of the collaboration: the joint production of the two-colour Atlas for which the SRC Schmidt would provide the ESO Sky Atlas Laboratory with the “blue” plates on IIIaJ emulsion, and the ESO Schmidt the “red” plates on 094-04 emulsion. Other items of this agreement included market exploration, selling prices, the number of copies to be made, etc., and the fact that the Sky Atlas Laboratory would handle the production, distribution and sale on a non-profit basis. The Atlas referred to here, containing 606 fields between declinations  $-20^\circ$  and  $-90^\circ$ , was made on film.

The third part specified the production of a small number of copies of the Atlas on glass: 6 for SRC and 4 for ESO.

## The ESO-Uppsala Faint Galaxies Survey

As a last item in this early history of the Schmidt telescope, I shall briefly dwell on the birth of the ESO-Uppsala faint galaxies project. When early 1973 the first Schmidt plates of atlas quality became available, astronomers' thoughts naturally went to the many research projects for which they might be used. As mentioned before, a most important field of application would be the study of extragalactic stellar systems. Was there a task for the ESO Directorate beyond just providing the astronomical community with the Atlas?

A comparison may be drawn with an earlier situation in astronomy when, in the beginning of this century, wholesale spectral classification by means of objective prism plates became possible. Harvard Observatory then initiated the systematic cataloguing of the spectral types of all bright stars, resulting in Annie Cannon's monumental Henry Draper Catalogue. With its more than 200000 stars it has been a basic reference in stellar research since then. Now, with extragalactic research being opened up in the southern sky, shouldn't it be a task for ESO to promote the provision of the community with a basic catalogue of galaxies, down to a well defined observational limit and specifying main characteristics such as Hubble type and apparent magnitude? Many considerations pointed to answering "yes", including the important side effect of ensuring uniformity in the identification numbers to be used in the future.

Since the task would be far beyond what might be done by the ESO staff itself, collaboration with an astronomical institute, preferably in one of the ESO countries, would be the solution and this led the ESO Directorate to approach in the spring of 1973 the Director of Uppsala Observatory, Eric Holmberg. Uppsala observatory was one of the few in the ESO countries with an established tradition in extragalactic work, including work of statistical nature. A major project published in 1973 was P. Nilson's Uppsala General Catalogue of Galaxies, containing data for nearly 13000 galaxies north of declination  $-2^{\circ}30'$  and based on the Palomar Sky Survey [23]. In reply to a formal letter of May 16, 1973 of the ESO Director General, Holmberg expressed his interest in the proposition and sketched first outlines for the collaboration in a letter of May 27. Further correspondence and meetings between ESO and Uppsala staff led to a formal agreement between the two institutes of February 8, 1974 [24].

In the course of the negotiations, for ESO the Head of the Sky Atlas Laboratory, Richard West, became more and more involved, and soon took this project, too, under his wings. The agreement specified, among other items, that the Uppsala search was to be made by an astronomer at Uppsala Observatory on copies of the original plates of the Quick Blue Survey especially made for this purpose; an Annex, apart from giving technical

details, stated that besides galaxies satisfying certain observational criteria, also a selection of stellar clusters and planetary nebulae were to be included. The criteria to be adopted for the selection of the galaxies were the same as those used by Nilson so that homogeneous coverage of the northern and southern parts of the sky would be assured.

In a letter of February 20, 1974 to the Director General of ESO, Holmberg wrote that, since November 1973, the work had been going full force by Andris Lauberts, and a first batch of 20 plates were under survey. A comprehensive description of the project was published in 1974 by Holmberg, Lauberts, Schuster and West [25].



## XI. POLICY, PAYMENTS AND A BIT OF POLITICS

*“German astronomers would be very happy if in the long run not only the [ESO] Administration, but also scientific activities could be located in our country”.*

From a statement by the German astronomical Council delegate in December 1973.

### Introduction

The present chapter concludes my account of ESO's early history. We first followed the developments leading to the signing and ratification of the ESO Convention in 1962 and 1964, and the simultaneous searches for sites, first in South Africa and later in Chile; next the first phase of constructions in Chile concluded with the dedication ceremonies on La Silla in March 1969, and then first scientific activities. We saw that by the time of the dedications first thoughts were given by Directorate and Scientific Programmes Committee to developments of ESO beyond the Initial Programme of the Convention, but that their follow-up was stifled by the growing concern about the completion of the 3.6-m and the Schmidt telescopes. Subsequent progress in these two telescope projects was described in the last three chapters.

In dealing with these latter subjects, I entered into the period of my own Directorate of the Organization. As a matter of principle I did not want to cover that period except for those items for which developments were well under way in preceding years and hence would naturally ask for an account of their follow-up, as was the case with the 3.6-m and Schmidt telescopes. Thus, my account did not cover a wide range of developments following the 1969 dedications, such as: the scientific work by ESO staff in Chile and by visiting astronomers; the large construction programmes carried out in Chile; the more detailed account on the work of the TP Division; and the steadily progressing effort of the ESO Administration and Finance Committee in establishing the framework of rules and arrangements governing staff positions.

This concluding chapter will again deal with two subjects that rooted in ESO's earliest days. First, we take up some matters of general policy that were on and off the subject of, sometimes rather pithy, discussion. Next we shall deal briefly with an important aspect that so far was hardly touched: the financial one – what it all cost and how it was paid for.

## MATTERS OF POLICY

Two matters of policy ran, since the earliest days, as a continuous thread through the deliberations of Directorate and Council: a) the question, to what extent ESO should have a nucleus of research-oriented astronomical staff, and b) the problem of ESO's geographical dispersion, particularly the dispersion in Chile. Although the two subjects are interrelated, let me deal with them consecutively.

### (A) ESO, A Centre for Research?

In chapter VII I quoted the opening statement by the advisory committee that in 1965 submitted to Council opening recommendations on the way the Observatory should operate: "*Whereas the role of the Observatory as an astronomical institute in its own right --- should be of great importance, the facilities should particularly be available to serve the national interests of the member states*". We recognize here two conceptions between which the Organization swung since then, a role as "*observatoire de mission*" and one as a research institute in its own right. I referred to this ambiguity earlier, in chapter VI in connection with the creation of the Santiago Headquarters.

In 1968, as described in chapter VII, the newly created Scientific Programmes Committee proposed the creation of an ESO Centre in Europe, to serve a double purpose: offering a meeting ground for astronomers, and a place where auxiliary measuring equipment could be developed, to be used in conjunction with the observational work on La Silla. As we have seen, this suggestion as well as others of the SPC met little response when early in 1969 the problem of the realization of ESO's main telescopes began to dominate Council deliberations. However, the proposal contained elements that in the years following would recur with increasing urgency in discussions between Directorate and Scientific Policy Committee on the one hand, and Council on the other hand.

The matter was expressly brought up in part II of document Cou-60 of December 1969 (to the first part of which I referred in chapter IX), written in preparation for the new policy to be adopted for the realization of the 3.6-m telescope and resulting in preference for the collaboration with CERN. With the prospect of the strong technical group to be built up at CERN that would absorb anyhow the small but growing technical group at Hamburg-Bergedorf, and with the threatening dispersion of ESO's establishments in Europe (on top of that in Chile), it seemed attractive to move to the vicinity of this technical group also the other services of Hamburg and establish there the ESO Centre suggested in earlier proposals. Naturally, there was the difficulty that Switzerland was not yet a member of ESO, but efforts to achieve this were under way. An obvious advantage of such a move would

have been the opportunity for natural interaction between the three astronomical groups: that in Europe involved with the visiting astronomers programme, the astronomical staff at the TP Division, and astronomers from Chile visiting Europe. Also, favourable conditions would be created for further pursuing the Scientific Programmes Committee's proposals for a new generation of telescopes referred to earlier.

As was reported in chapter IX, Council in December 1969 encouraged the further exploration of collaboration with CERN for the large telescope project and this eventually led to the creation of the TP Division. The question of the ESO Centre was, however, referred to a special advisory committee Council intended to create for dealing with matters of general policy [1]. As we saw in chapter IX, the French delegation at that time stressed the importance of first of all concentrating all efforts on the construction of the large telescope. Reluctance with regard to the coupling of the telescope project and a "Centre" was more specifically heard from the side of the German delegation: *"The central ESO institute is some sort of ghost going around. --- As long as --- a study is not available, we have to separate the two questions: --- the large telescope and the central institute"* [2].

### **The Scientific Policy Committee Created**

The special advisory committee just mentioned, to be called Scientific Policy Committee, was created in the Council meeting of June 1971 and meant to advise Council on matters brought up by Council as well as such it might take up on its own initiative [3]. The Council meeting of December 1, 1971 appointed its membership: Ludwig Biermann, Jean-Claude Pecker and Bengt Strömgren, with the latter as its President. The acronym SPC would henceforth refer to this new committee, and the former SPC became Observing Programmes Committee (OPC). President of this latter became Pol Swings. The meetings of both committees up to the end of 1974 are listed in Annex 6. This new SPC, with its small membership, soon became a welcome sounding-board for the Director General when it came to matters of general policy.

Meanwhile, the matter of the ESO Centre had remained more or less dormant in 1970 and 1971. These were not only the years in which the TP Division took up its task; the ESO Directorate also was confronted with increasingly serious economic problems in Chile that required a variety of measures in the personnel sphere [4].

## A Research-Oriented Group at ESO?

The question of the Centre was taken up by the (new) SPC in its meetings of April and October 1972, at the last one on the basis of a proposal submitted by the Directorate: "Preparation for the Optimum Use of the 3.6-m Telescope" [5]. In the course of that year, with the work of the TP Division in progress, it had appeared desirable to take first steps towards ensuring that the astronomical community in the member states would be prepared for making full use of the large telescope, once this would become operational. It was not obvious that this would be the case. For instance, research with the large telescope might be expected to concentrate mostly on extragalactic problems, i.e. the study of stellar systems outside the Milky Way system, whereas around the year 1970 research on our own system, the Galaxy, dominated observational work [6]. The proposal received strong support from the SPC in its October 1972 meeting and could be summarized as follows [7]:

*"1) ESO aims at creating without delay a small group of astronomers with the task*

*– a. to help orienting research in the ESO member-states towards those programmes, to which the 3.6-m telescope may be applied with its optimal efficiency;*

*– b. to help orienting the development of auxiliary instrumentation towards the application of these programmes;*

*2) The group should have a small nucleus of permanent or semi-permanent members, and for the remainder consist of a rotating membership (visiting scientists)."*

The group was meant to be located preferably at the TP Division; it was proposed that budgeted provisions be made for three first appointees, and that it should be guided by a senior astronomer of outstanding qualification [8].

The Committee of Council in its meeting of October 31, 1972 was in majority favourable to these ideas and amended the proposal in the sense that leadership of the group might be combined with the still vacant position of Deputy to the Director General which had been created in connection with the retirement of Ramberg at the end of 1971 [9], and a correspondingly amended proposal was submitted to Council [10]. The amended proposition seemed particularly interesting because by that time an astronomer of outstanding qualification had, in private, expressed to the Director General interest in this leadership. However, contrary to expectations raised at Committee of Council, the Council meeting of November 1972 held in Chile acted reluctantly. It authorized the Director General to approach the person concerned about the intended association with ESO, but rejected creation of the research-oriented group [11]. As a result, interest on the part of the person concerned faded.





### ***The ESO Guesthouse in Santiago from the air***

*The Guesthouse was bought in the year 1964 as a pied-à-terre in Santiago and served in the early years for both the administrative offices and for lodging visitors from Europe. In the early 1970's it was contemplated to sell the Guesthouse and incorporate its function for visitors into the Vitacura Headquarters building. The idea was not, however, pursued any further.*

*From photograph in the EHPA.*

### **The Workshop Proposal**

The question of the orientation of research with the 3.6-m telescope was again on the agendas of the SPC meeting of March 28, 1973, and of Committee of Council on the day following. This had been preceded by consultation of the President of the SPC and the Director General with a prominent astronomer in the member state from where much of the resistance appeared to stem, the German Federal Republic, and this had led to an alternative suggestion: instead of creating the research-oriented group within ESO, ESO might “— — — organize a succession of Workshops, each of about 6 months duration, with participation of astronomers from astronomical institutes of the ESO countries, who would be on leave of absence from their home institutes for the duration of the Workshop. — — —” [12]. Although it

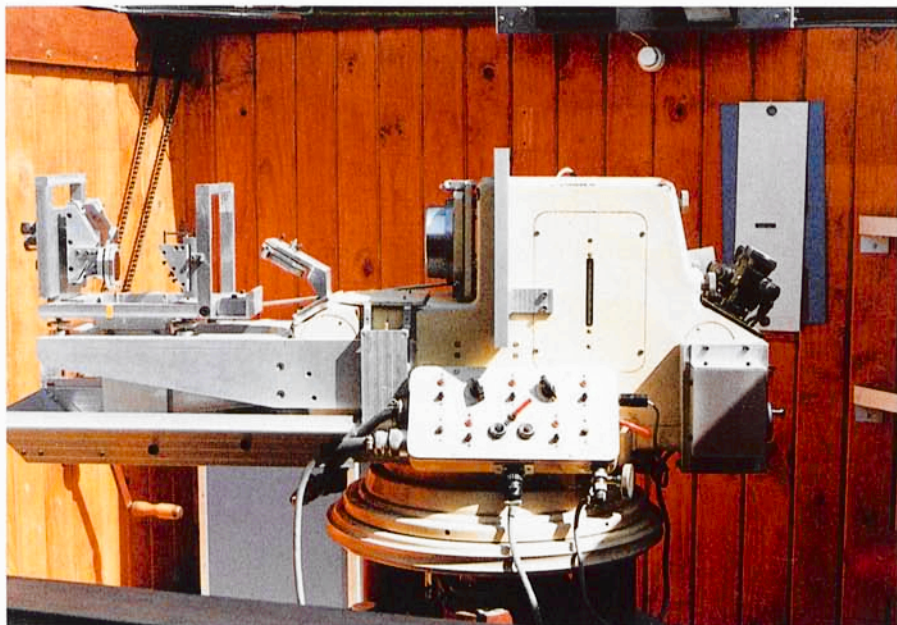



***The ESO Astrolabe at CERRO Calan Observatory***

*Since its installation, at the end of 1965, at Cerro Calan Observatory of the University of Chile, the Astrolabe has been in regular operation. Under the supervision of F. Noël it observed, among other objects, the stars in the FK4 Catalogue which embodied the fundamental reference system of stellar positions, and it contributed important improvements to this system. The collaborative agreement between Cerro Calan and ESO dates from April 29, 1965; by this agreement, the desire expressed in the ESO Convention for ESO contributing to positional astronomy was fulfilled. The photographs show: above the astrolabe as it was installed originally, and above left, after modernizations had been introduced in 1989. The photograph left below shows Cerro Calan Observatory, in the outskirts of Santiago, with the Astrolabe housing in the lower left.*

*These photographs were kindly made available by Dr. F. Noël.*

was realized that in this way the most urgent task Directorate and SPC had in mind, working out a programme for the auxiliary equipment for the 3.6-m telescope, would not be taken up as expediently as in the original proposal, Committee of Council recommended the Workshop proposal to be worked out in detail by the Directorate, especially for its financial implications.

A second meeting of Committee of Council followed soon, on May 18, 1973 in preparation for the June Council meeting. The fact that, in this case, two meetings of this Committee preceded the Council meeting reflects the concern about developments felt by the Directorate as well as by the SPC. This concern found its expression in a rather extensive document, Cou-142, prepared by the Directorate: "Notes Concerning some Imminent Problems and Related Matters" of May 10, 1973 [13]. With the termination of the current terms of appointment of the Director in Chile (per June 1974) and of the Director General (per January 1975) in sight, the document reviewed, more broadly than had been done before, developments within ESO that required early adjustment or clarification. It paid special attention to certain aspects of the Office of the General Directorate and to ESO's geographic and organizational structure, including the suggestion that part of the astronomical activities in Chile might be incorporated in the establishment in Europe.

Most of the extensive discussion in the Council Meeting of June 5 and 6, 1973 was devoted to these problems, both on the basis of an extensive report of the Chairman of the SPC, B. Strömberg, and in reaction to the above-mentioned document, Cou-142. There was uneasiness about the Workshop proposal. However, with the prospect of a review of ESO's entire structure, no final conclusion was reached and the Directorate was requested to submit to Council "*--- proposals and possibly alternative proposals on the future role of ESO in encouraging and organizing cooperation in research in the Member States, and in promoting the development and construction of the auxiliary instrumentation ---*"; this study "*--- to be used for the preparation of decisions on the future structure of the Organization. ---*".

At this meeting, the SPC was strengthened by the appointment of Lodewijk Woltjer as its fourth member, and broad consultation with astronomers in the member states was encouraged [14].

### ***ESO Headquarters in Santiago***

*After the dedications in Chile in 1969, the Headquarters in Santiago housed the administrative services and assumed an increasingly important role in ESO's activities in Chile. In these photographs: above: the Headquarters building seen from the entrance gate; below: the reading room in the library with in the foreground, at left and right, astronomers François and Monique Spite.*

*From photographs in the EHPA.*





### ***Bus Stop at Los Villos***

*Early October 1971 the ESO Finance Committee held its (21st) meeting in Chile (its second one in that country). As was customary in those days, the trip from Santiago to La Serena was made by bus, with a lunch stop at Los Villos or Pichidangui in flowery surroundings at the coast. Shown here, during a moment of post-lunch relaxing, from left to right: C. Zelle (President Finance Committee), Hedwig Geier (Secretary of Director General), and the author.*

### **A Formal Statement from German Side**

Besides the above necessarily very condensed account on these deliberations on general policy in the middle of 1973 (in fact, too condensed to reflect the range and depth of the discussions), we must record an initiative that would turn out to have far-reaching consequences for ESO. It was at this Council Meeting of June 1973 (as well as at the preceding meeting of Committee of Council), that a remarkable formal statement was read by the German delegate. After referring to the “*observatoire de mission*” concept favoured from German side, the statement, apart from other items, expressed the opinion that with the completion of the 3.6-m telescope ESO’s activities would be mainly in Chile, including the office of the Director General. However, as to the services then left in Europe, it said “ — — — if

*ESO feels the necessity to put its European office at Hamburg in a stronger position, – – – I am authorized to state: My government is ready to give all its support to hosting ESO in the Federal Republic of Germany under optimal conditions, thus promoting the European cooperation which is one of our principal aims – – –* [15]. At the meeting of Committee of Council preceding this Council meeting, the President of the SPC, Strömgren, had shown particular interest in this statement and expressed the hope that the proposition might be studied in depth in connection with the problems presented in Doc. Cou-142 [16].

### **Response by Directorate and SPC, Doc. Cou-150**

In response to Council's request the Directorate submitted by the end of 1973 an extensive recommendation, Doc. Cou-150. Annexed to it were "Considerations by the Director General" as well as supporting reports on behalf of the SPC and the Instrumentation Committee, and Notes by the Director in Chile. The SPC had thoroughly discussed the items raised in document Cou-142 at its meeting of September 14; it had invited for this, apart from its membership (Strömgren, Biermann, Pecker und Woltjer) also the Chairman of the IC, J. Borgman, and B. Gregory, former Director General of CERN and now Director of CNRS, and R. Lüst, President of the Max-Planck-Gesellschaft.

Among its main items document Cou-150 supported the Workshop Programme, however for the organization and follow-up it recommended establishing a small group of ESO staff astronomers that would also incorporate the Visiting Astronomers Service (the organization of the observational programmes in Chile), and that should closely collaborate with the TP Division. Furthermore, it strongly recommended [17]:

*"I. To consolidate the activities of ESO in Europe by removing the present activities at Hamburg to Geneva during the 5-years period [required for the completion of the work of the TP Division]:*

*II. To review before the end of this 5-years period – preferably within the next 2 years – the question of the location of the consolidated headquarters in Europe on the basis of ESO's scientific purposes."*

### **Council's Resolution December 1973; the German Offer**

Thorough deliberations of Council in its meeting of December 13-14, 1973, partly in closed session, resulted in a long and detailed formal resolution [18]. It supported the Workshop Programme but wished it to be executed by Visiting Scientists on leave of absence from (preferably) European institutes instead of the proposed nucleus of ESO staff. It did, however, recognize the importance of simplification of the structure of ESO and in this connection

*“Gratefully acknowledge[d] the possibility offered by the German Government to establish the Headquarters as well as other facilities of the Organization in the neighbourhood of German astronomical and technological establishments – – – “. It requested the Director General to “study the offer of the German Government as well as any other proposals which might emanate from Member States for the Organization’s Headquarters and other facilities in Europe.”, and “to make proposals for a provisional transfer of his office, or part of it, to the site of the TP Division – – – ”.*

The German offer referred to in this resolution had meanwhile become more explicit than half a year earlier. A statement by the German astronomical Council delegate reported positive reactions among German astronomers (including the Rat Westdeutscher Sternwarten) with regard to the recommendations in document Cou-150, but added: *“German astronomers would be very happy if in the long run not only the [ESO] Administration, but also scientific activities could be located in our country”,* and specifically mentioned the possibility of an establishment in conjunction with the astrophysical institutes at Garching near München. More explicit statements were presented by both the Government delegate on Council and a representative of the Foreign Ministry of the Federal Republic, who especially for this item joined the German delegation. According to the former *“– – – it was necessary to distribute research organizations fairly throughout Europe, – – – avoiding a concentration of efforts in one place – – – ”,* reasons why *“the German delegation had been instructed to say that part of the proposal presented was difficult for the German Government to accept.”* The representative from the Foreign Ministry, after referring to the effect of the choice of a site on public opinion, added *“– – – all the more so when so few international organizations are located on [our] territory”,* and concluded with *“My Government, therefore, would be grateful if ESO were to accept the offer of a suitable site in Germany.”*

**Finance Committee in Chile**

*In October 1971 Finance Committee made itself acquainted with developments on La Silla and in Santiago. In these photographs, taken on La Silla, from left to right:*

*Top photograph: Miss H. Geier (Secr. of Dir. Gen.), H. Grage (DK), C. Zelle (GFR; partly hidden behind Grage), B. Samuelsson (S), A. Blaauw (Dir. Gen.), H. Dumont (F), P.A. Bernard (F).*

*Bottom photograph: M. de Groot and H.-E. Schuster (ESO astronomers), and in the front row C. Zelle (GFR), H. Dumont (F), H. Grage (DK), P.J. Fierst van Wijnandsbergen (NL), B.E. Westerlund (ESO Dir. Chile).*

*From photographs in EHPA.*





## The Political Aspect

Clearly, for the German delegation the question of the location of the future Centre of ESO had grown to include more than just the interest of ESO itself: it had a political aspect. Whereas nearly all European organizations had their headquarters outside the GFR, notably in Geneva, Paris, Brussels, Rome, etc., there were very few within the GFR notwithstanding the fact that the GFR was one of their main financial contributors. With ESO's administrative headquarters and some related services having been in the GFR since their creation, it had become a concern at government level not to let ESO also drift to other territory. With astronomy at large gradually entering the era of "big science", ESO, too, unavoidably entered the domain of political attention.

## The Year 1974: the Centre in Sight

During the year 1974, a variety of measures in Chile absorbed a good deal of the managerial capacity of the ESO Directorate. An interim report on the implementation of the Council resolution, presented at the June 1974 meeting of Council, revealed that no alternative offers for sites for the European Headquarters were to be anticipated from Denmark, Sweden and The Netherlands, and the German offer had been the subject of consultation between the Directorate, the SPC and the Max Planck Gesellschaft. A study of the temporary transfer of Hamburg facilities to Geneva was under way [19]. A promising step towards orientation of research with the 3.6-m Telescope, had been the successful ESO/SRC/CERN conference on research programmes, held at CERN on May 27-31, 1974 [20].

Naturally, by this time, mid-1974, many of the measures had to be viewed in anticipation of the succession in the General Directorate per 1 January 1975. Meanwhile, two important future developments began to stand out: a temporary enhancement of the role of the TP Division by the incorporation of services so far located at the Hamburg Office, and the prospect of the creation of a comprehensive and representative Headquarters near Munich.

By the end of the year, the views of the new Director General, Lodewijk Woltjer, had firmly put their stamp on further planning, as is apparent from the following quotation from the minutes of the meeting of Committee of Council of November 1, 1974 "— — — *B. As to the creation of an astronomical Centre in Europe, which had been made a condition by Professor Woltjer for his acceptance of the position of Director General, — — — a course of action would seem to be acceptable — — — which would comprise the following: 1) In the frame of the 1975 budget, — — — to start recruiting a nucleus team for the astronomical centre. — — —*". The Centre was envisaged to be established temporarily on the premises of CERN [21].

## **(B) ESO's Geographical Dispersion**

From the time when, in March 1969, the dedications in Chile concluded the first phase of constructions and the Headquarters in the Vitacura suburb of Santiago assumed its functions, the La Serena Office became of secondary importance but it remained indispensable as a base for the La Silla operations. Besides these three Chile components, there were the Guesthouse, also in Santiago not far from the Headquarters, and at the base of La Silla the Pelicano complex of storehouse and services, in use since the very first construction activities for La Silla. Visitors from abroad wondered at this multitude of settlements, and it is not surprising that members of Council and Finance Committee on the occasion of their visits to Chile critically enquired whether not the situation implied inefficient use of manpower and finances. We have seen in chapter VII that, indeed, in 1969 this was one of the items of review by the Working Group of Funke, Alline and Scheidemann; however, the Group refrained from recommending changes.

### **Extension of Facilities in Chile**

The question of the structure in Chile was brought to the foreground again in 1972, when the TP Division's activities had to be extended to Chile: the construction of the building and dome for the telescope, and related auxiliary and support constructions (for instance, lodging facilities for the construction workers). In addition to this, an extensive (and expensive) programme lay ahead for providing facilities required for the operational phase with its increased observational activity. A comprehensive scheme, drafted in collaboration between the TP Division, the Directorate in Chile and the General Directorate was submitted to FC and Council in April 1972 [22].

This scheme foresaw, besides constructions in La Serena and on La Silla, also extension of the Headquarters in Santiago, but Council in its meeting in June 1972 considered that this could not be separated from the long-range policy for the establishments in Chile: *"whereas from the beginning it was decided to create in Santiago the Headquarters --- and this policy of Council was maintained for almost 15 years, in recent times the question arose whether, indeed, there are not disadvantages in having these establishments so far from La Silla and whether not the operation of the Observatory is hampered by the remoteness of the facilities in Santiago. ---"* [23]. Decisions on the building programme were postponed until, in November of the same year, Council would judge matters in situ during its visit to Chile.

At this November, 1972 meeting important moves were made indeed toward the extension of facilities in Chile. In La Serena, land was to be purchased next to ESO's Las Cisternas compound for the construction of more housing of ESO staff and a technical office was to be added; in the La

Silla – Pelicano area, living quarters for local personnel were to be constructed, and workshops, storehouses and service stations were to be moved to La Silla. The proposed extension of the Santiago Headquarters, however, was not granted and it was contemplated to sell the Guesthouse and have it incorporated in the Headquarters establishment at Vitacura. Transfer of the Headquarters or part of it to La Serena was not favoured for the time being, in view of the increased activities now expected in the La Serena area [24]. Also, at this time, in the context of proposals for the ESO Centre, serious consideration was given to the proposition that part of the Vitacura services be moved to Europe [25].

### **Moving “Vitacura” to La Serena?**

An important next step was, a year later, a recommendation by the Director General and the SPC of November 1973, in Document Cou-150 to which we referred before. With regard to the integration within Chile it recommended to further investigate *“the advantages (respectively disadvantages) and financial implications of a move of the Vita Cura establishment to La Serena, in order that by the time the 3.6- telescope comes into operation (medio 1976) the optimal geographic structure in Chile may be attained”* [26].

Naturally such a move would have far-reaching consequences for the work and the living conditions of ESO’s staff in Chile. The views of ESO’s Director in Chile, B.E. Westerlund, presented in the preparation of Cou-150, were included as Annex IV to this document. As a result of his balanced weighing of the advantages and disadvantages of a move, Westerlund concluded: *“Summarizing today (27. 10. 1973) my feelings on Santiago versus La Serena I conclude that if ESO makes an effort to solve [problems concerning schooling, medical assistance and cultural environment], most staff will see a move with calm. If it is worth from an economical and PR view, I do not know. With “normal” time returning to Chile in the future, I doubt it.”* These

#### **Visit to President Allende**

*On the occasion of Council’s visit to Chile, in November 1972, a delegation from ESO paid a visit to the President of the Republic of Chile. The top photograph shows President Salvador Allende talking to, from left to right: A. Alline, President of the ESO Council; A. Blaauw, Director General of ESO; C. Zelle, President Finance Committee; B.E. Westerlund, Director of ESO for Chile; and (seen from behind) B. Strömgren, President Scientific Policy Committee. Bottom photograph: A. Alline presenting President Allende with a collection of pictures of ESO.*



latter words remind us of the facts that economic conditions in Chile in the course of the past years had strongly deteriorated, that six weeks before Westerlund wrote this letter the coup d'état had taken place, and future conditions in Chile seemed unpredictable.

The Council meeting of December 1973 requested the Directorate to prepare specific proposals for restructuring in Chile and redistribution of tasks between Chile and Europe [27].



***Camp Pelicano, April 1972***

*In the context of the restructuring of ESO in Chile, part of the logistic services that had developed at Camp Pelicano from the earliest construction stages on La Silla, were moved to La Silla, but the Camp continued to be the entrance gate to the Observatory. A comparison with the photograph taken in January 1966, shown on page 92, shows the development over six years. On the nearest side we recognize the two large storage buildings.*

*Photograph in EHPA.*

## The Year 1974: Restructuring in Sight

Restructuring in Chile was pursued in 1974 but at a slow pace due to the special circumstances that developed in this country, and also because views of the new Director General would more and more have to be taken into account. The minutes of the Council meeting in June of this year reported: *“Regarding a transfer of the Vitacura facilities, studies were under way with a view to finding an adequate alternative site at La Serena. Certain contacts had been made with the local government official concerned (Intendente) during the spring of 1974. Any further negotiations would be conducted probably on the Foreign Ministry level. There would be the question of construction costs and of social implications, including the provision of school and medical facilities. --- For the further improvement of communications, particularly in circumstances where rapid transport was required, an air-strip was being constructed at Pelicano under a recent Council decision. --- “ [28].*

Giving final shape to restructuring in Chile would be the task for the new Director General. Drastic measures were in the air, including considerable reduction of the role of the Vitacura Headquarters.



### *Pelicano airstrip inaugurated*

*On November 20, 1974, the Pelicano airstrip was inaugurated when I introduced my successor Prof. L. Woltjer to La Silla. From left to right: A. Bosker, L. Woltjer, the author, H. Ponce, E. Bechmann, S. Ojeda, H. Franz and B. Gronbech.*

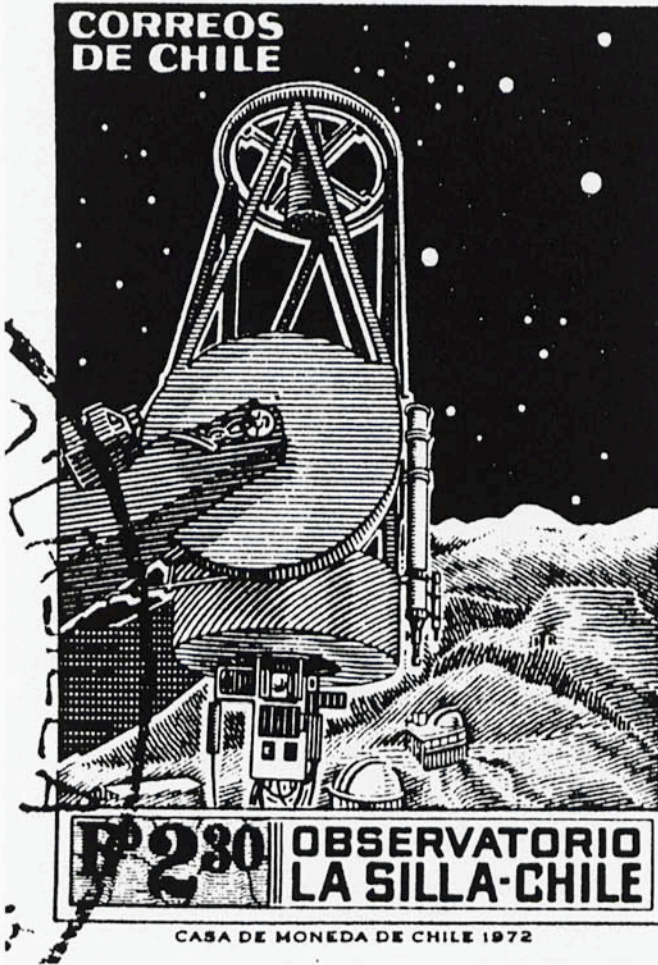

***La Silla on Chilean Post Stamp***

*On April 25, 1973 Chile issued a post stamp depicting the 1-m Photometric Telescope with part of La Silla in the background. On the artist's sketch we recognize the flattened top on which the 3.6-m Telescope was to be erected and, in front of it, the Schmidt telescope building and part of that of the GPO. (See also the photograph on page 176.) Photographed from a leaflet issued by the Dirección Nacional de Correos y Telecomunicaciones de Chile, and carrying the First-day-of-issue stamp. The leaflet is shown opposite. (Property of the author.)*



Impresión: Offset

Dimensiones: 26 x 39 mm.

Color: Negro y Azul

Valor E<sup>o</sup> 2,30

Tiraje: 5.000.000 de ejemplares

**Motivos y Leyendas:**

En el ángulo superior izquierdo lleva el título "Correos de Chile" en dos líneas. Al centro, como motivo principal se encuentra el telescopio original del Observatorio Astronómico del Cerro La Silla, sirviéndole de fondo parte del firmamento y de la Cordillera de los Andes. En el ángulo inferior izquierdo se encuentra el valor "E<sup>o</sup> 1,15" y en el derecho la leyenda "Observatorio La Silla - Chile", en dos líneas. Más abajo, fuera del marco, se encuentra el pie de imprenta "Casa de Moneda de Chile - 1972".



## THE FINANCIAL STORY

Reviewing finances, we distinguish three phases: the pre-Convention period, beginning early 1954 when it was proposed to create ESO and ending early 1964 after the signing and ratification of the Convention, the next one concluding with the dedications in Chile in 1969, and the third one ending in more or less open-ended way in the middle 1970's with the completion of the 3.6-m Telescope Project.

### The Pre-Convention Period, 1954–1963

These early years called for improvisation. With the Convention still pending, there was no internationally agreed obligation for the governments to provide financial means for preparatory work that could be taken up right away: site tests in South Africa and planning for the instrumentation and first design studies. One wished to go ahead, and fortunately so, for, as we have seen, it took nearly ten years before the Convention was ratified.

Under the supervision of the ESO Committee (the predecessor of the ESO Council), budget estimates were drafted and the funds required were obtained in different ways in the various countries. In the Netherlands and Sweden, the government-sponsored science foundations supported the ESO project on a year-to-year basis, and in other countries ministries of science or their equivalent collaborated; the ESO archives do not clearly reveal their exact nature. The efforts were co-ordinated and administration was carried by the provisional treasurer J.H. Bannier.

For fixing the shares of the five participating countries after, in an early stage, Great Britain had withdrawn, the following key was used: the Federal Republic and France would pay one third each, with the remaining one third to be shared by Belgium, the Netherlands and Sweden proportionately to their Gross National Incomes (which at that epoch were virtually equal). The system was flexible enough for one or more of the partners to help out with an advance if financial problems arose in one of the other states, and in the years 1958 and 1959, when no financial contributions could be expected from internally disturbed France (see chapter I), these were bridged by a temporary arrangement by which Germany paid 49% and the other partners about 17% each [29].

Naturally, the lack of financial guarantee was a serious drawback, but on the other hand, the situation left room for improvisation. Budget estimates made and agreed upon in advance of the fiscal year could fairly easily be adjusted later if developments required so, and in such cases the ESO Committee benefitted much from the authority which members of the Committee carried in their consultation with government officials at home.

As a consequence, establishing now the amount of the early contributions from the financial documents left in the ESO Archives is done more by means of a *posteriori* reports than by looking at the advance budget planings.

## **About Dollars and Deutschmarks**

The currency in which the budget estimates and, hence, the contributions of the member states were expressed during the first two decades (in fact until 1973) was the US Dollar, with the exception of a brief period in the very beginning when the English Pound figured. The choice of the dollar was a natural one: cost estimates of instrumentation were mostly based on American experience, the dollar tended to be stable and the choice was not biased towards any of the ESO partners. Yet, for the presentation in this chapter I shall use the Deutschmark, the currency in which ESO budgets nowadays are defined. This gives a better feeling of costs and contributions when compared to those of modern European operations.

For the conversion factors of Dollars into Deutschmarks over the years I used tables provided by the ESO Administration [30]. Until 1970 the rate was about 4 DM per Dollar, during the 1970's it gradually diminished to 1.8 DM per Dollar and rose again in subsequent years. However, using this currency is not enough for the desired comparison; we also must take into account the inflation over the years, i. e. the gradual change (decrease) of the purchasing power of the DM. Where this is done here, it is based on inflation tables also provided by ESO [31]. To give an idea of its importance: in the second half of the 1960's the purchasing power of the DM was about 1.8 times larger than by the time (1976) the 3.6-m Telescope became operational, and it was 2.7 times larger than it is at present (1990). The inflation of the DM has been very smooth; it is illustrated at the bottom of Figure C.

In what follows I shall use the following notations:

- DM for Deutschmark converted from dollars at the rate valid at the epoch concerned;
- dm for Deutschmark adjusted to present day level taking into account the inflation.

The principal source of information used for the present compilation are the reports of the external auditors of ESO. These are agencies, designated in turn from the member states, with the assignment to scrutinize from impartial point of view the financial administration of the Organization. Sometimes their reports also bring up matters of management. These quite valuable reports form part of the files of the Head of Administration [32]. For the period preceding the ratification of the Convention, for which auditor's reports are not always available, part of the data was derived from the minutes of the meetings of the ESO Committee [33].

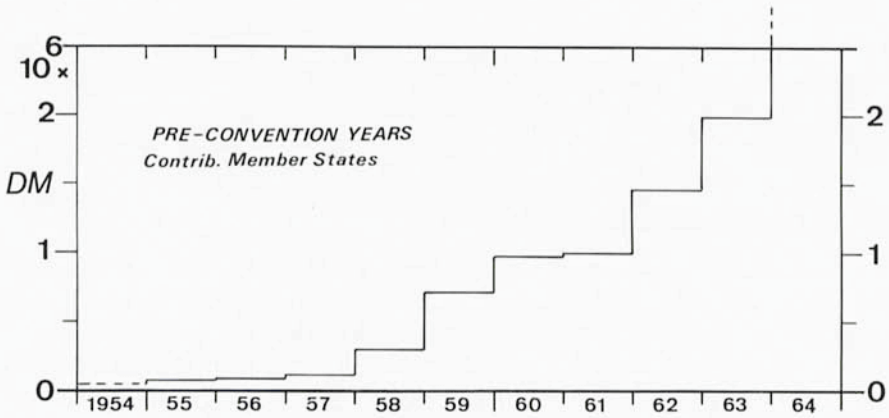

**FIGURE A.** — *The total of the annual financial contributions of the prospective member states over the period from conception of ESO till the ratifications in 1964. The principal expenses to be defrayed from these contributions were the site testing expeditions in South Africa and the connected observational programmes with the Marseilles GPO and the Tübingen photometric telescope.*

### Early Annual Contributions and Project Costs

We first illustrate the development of the total of the early annual contributions of the member states; see Figure A. Here, no corrections for inflation have been applied yet. We see that from 1955 to 1963 the contributions grew from about 100.000 DM to 2 million DM. Integrated over the years ending with 1963 we find a total of 6.8 million DM (17 million dm). During these early years contributions were used partly for the site testing expeditions and for the research programmes carried out in the context of these tests and described in chapter II: the Tübingen photometric work and the Marseilles radial velocity project with the GPO telescope. However, a sizeable unspent balance was also built up before the beginning of the post-Convention years; by the end of 1964 it amounted to about 9 million DM. (about 22 million dm), including the grant of one million dollar of the Ford Foundation (see chapter I), transferred to ESO in 1964 and corresponding to 4.0 million DM (9.4 dm).

### Early Cost Estimates

Starting point for the early long-range financial planning were, naturally, estimates of the total investment costs required for the establishment of the Observatory, accompanied by predictions of the ultimate running costs. In chapter I, I quoted the figures mentioned at the June 21, 1953 meeting of the ESO committee: capital investments of \$ 2.5 million (DM 10.5 million) and

annual running costs of \$ 100.000 (DM 420.000), as well as the revised figures of January 1954: \$ 3.5 million (DM 14.7 million) for capital investments and \$ 126.000 (DM 530.000) for running costs. In subsequent years the estimates of the capital investments increased and reached a value of \$ 5 million (DM 21 million, dm 56 million) around the years 1957 to 1960, a figure we encountered already in connection with the grant of one million dollars from the Ford Foundation described in chapter I, and at that moment equivalent to the average share of one of the five potential member states. This estimate of \$ 5 million figured prominently in negotiations with government agencies in the years of struggling for getting the Convention signed; in fact so prominently that years later, when it had been amply exceeded, certain government delegates could take naughty pleasure in bringing it back to astronomers' recollection . . .

The \$ 5 million estimate was based on the following components:

an up to date estimate of the costs of the Lick	
120-inch telescope . . . . .	\$ 3.500.00
an up to date estimate of the costs of a copy	
of the Palomar Schmidt . . . . .	600.000
meridian circle and auxiliary instruments . . . . .	100.000
workshops, buildings, houses . . . . .	100.000
roads, power, water . . . . .	100.000
unspecified . . . . .	<u>600.000</u>
	\$ 5.000.000

and on erection of the Observatory in South Africa. It figured, for instance, in the discussions in the EC meetings of April 1957 [34] and October 1958 [35]. It was estimated that the payments would be spread over 5 years once constructions could be started.

**The Post-Convention Years**

This time schedule of five years probably was still more or less what Heckmann had in mind when in his First Annual Report after ratification of the Convention, over the year 1964, he estimated that up to the end of 1970 the total capital investment would amount to about \$ 12.824.000 to which part of \$ 2.166.000 for Overhead expenses would have to be added, hence about \$ 14 million altogether i. e. dm 132 million. At that time, plans for the major instrumentation had changed radically; not a copy of the Lick telescope but the more powerful and considerably modified 3.6-m Telescope was planned, and also the Schmidt design had been modified. Of course, the principal component of the budget was the 3.6-m Telescope. Its costs, including building and dome was in 1962 estimated to be \$ 7.400.000 but a revised figure at the November, 1966 meeting of the FC became about \$ 1.2 million higher (mostly due to inflation), hence about \$ 8.6 million [36], i. e. 76 million dm.

Finally, at the end of the 1960's, an estimate of the total cost of the 3.6-m Telescope Project was contained in document Cou-59 referred to in chapter IX. It was compiled by the Technical Director J. Ramberg in preparation for the December 1969 Council meeting at the time when the new course for the realization of the telescope was under consideration. A breakdown into the main components of Ramberg's estimate follows:

For the Telescope:	
further design and development . . . . .	\$ 1.000.000
the optics . . . . .	1.715.000
the mechanical parts . . . . .	1.450.000
electric and electronic components . . . . .	1.100.000
aluminizing plant . . . . .	210.000
freight and assembling . . . . .	750.000
For the building . . . . .	2.500.000
For the dome . . . . .	<u>1.200.000</u>
	\$ 9.925.000

corresponding to DM 39 million or dm 82 million.

In comparison to the pre-Convention estimates, an other radical change resulted from the switch from South Africa to Chile, where construction costs, including those connected with water supply, power installations, and road constructions would have to be much higher than had been foreseen for South Africa.

### **The Annual Contributions from 1964**

In Figure B, the black line shows the joint annual contributions starting from 1964, the year in which the Convention was ratified. They are in DM, not yet adjusted for inflation. The blue line shows the annual contributions increased by additional sources of income, such as interest gained over unspent funds and increases or losses resulting from parity changes between the various currencies in which ESO held its bank accounts, and also the entrance fee of Denmark (spread over the years 1967, 1968 and 1970). The red line shows the expenditures. Unlike the principle I adopted for the earlier chapters, to describe only developments reaching into the early 1970's, in the present context we follow developments into the late 1970's.

### **Conflicting Interests and the Bannier Procedure**

We note, in Figure B, the smooth gradual increase of the contributions up to around 1975, in contrast to the much steeper rise in the curve of the expenditures. Strong fluctuations are typical for a project in its construction phase (in this case the work of the TP Division), but they entail conflicting

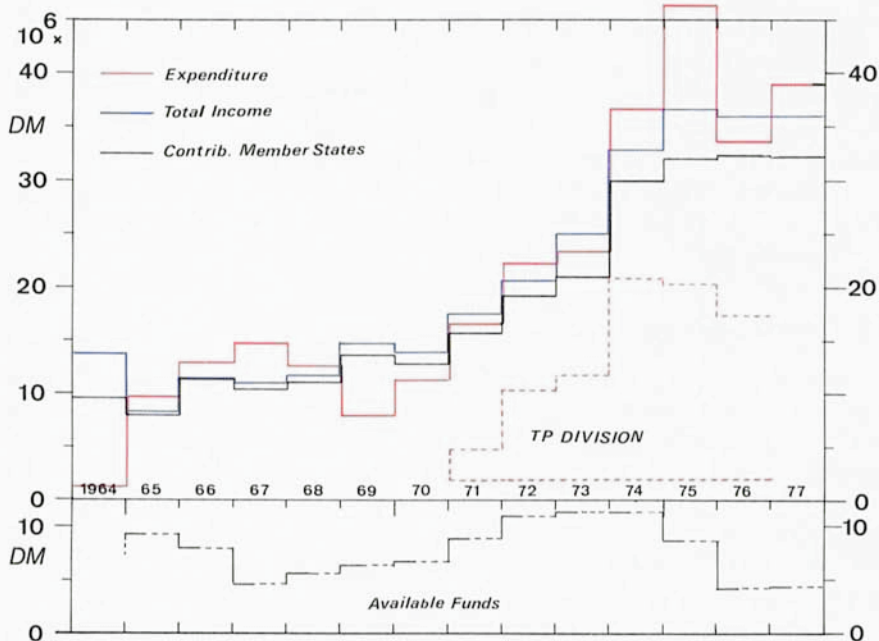

**FIGURE B. – Top part: Black line:** The annual contribution of the member states over the first 14 years following the ratifications. **Blue line:** The annual contributions increased with additional sources of income including interest from unspent balances (“Available Funds”). **Red line:** Expenditures; The dashed part represents the share of the TP Division in the years 1971 and later. **Bottom part:** Development of Available Funds (expressed in millions DM).

interests. On the one hand, that of the project management that wishes to realize it expeditiously and therefore needs to dispose of a considerable sum over a limited period. On the other hand, that of the funding agencies, in this case the governments of the member states, who dislike strong fluctuations in their budgets. Moreover, it is customary for government budgeting to avoid commitments beyond the next budget year although, of course, there must be room for long-term projects.

In order to avoid the undesirable shock effect that steep rises in the ESO budget might have, a system was adopted around the year 1970, introduced earlier at CERN and known by the name of its initiator: the [J. H.] Bannier procedure. It requested the organization to not only submit its budget proposal for the coming year, but also to deposit at the funding ministries a well founded estimate for the year following and an approximate one for the third year. The system has helped paving the way for the rapid growth of the ESO budget in the early 1970's.

### **First Post Convention Years, 1964–1969**

Soon after the Convention had been signed the construction programme in Chile, described in chapters V and VI, began to absorb considerable financial means. Accordingly, the annual contributions had to increase, but part of the expenses could be defrayed from the reserves that had been accumulated before 1965. By the time of the completion of the first phase, marked by the dedications on La Silla in March 1969, expenditures went down. This had not been foreseen originally, for at that time it should have been the turn for construction costs of the 3.6-m Telescope and the Schmidt, however, as we have seen in chapters VII and IX, these were delayed. This explains the dip in the expenses for the years 1969 and 1970.

Yet, in that period the annual contributions continued to grow. This was partly due to late realization that progress in the telescope constructions would be below expectation, but it also reflected the expectation that soon considerable expenses for these projects would be due anyhow. Thus, reserves were built up again around the year 1970 that came useful at later dates. The bottom part of Figure B shows how these reserves (called Available Funds in the external auditors' reports) developed in the course of time. Naturally, it was tempting for the financing authorities to use these reserves for reducing next years' contributions. Moreover, for an organization like ESO to put considerable funds on a profitable savings account meets little sympathy on the side of the funding agencies. Luckily, ESO Council and Finance Committee were tolerant in this matter.

### **The Years 1971–76; The TP Division**

The early 1970's saw the creation of the TP Division for the realization of the 3.6-m Telescope, and one of its first tasks was reliable budget planning. As a consequence, the required annual contributions rose steeply to a level that in the years 1974 and 1975 amounted to more than twice that around the year 1970. The documentation mentioned before allows singling out the financing of the TP Division from the remaining expenses. This leads to the presentation in Figure B. The dashed red contours outline the share of the



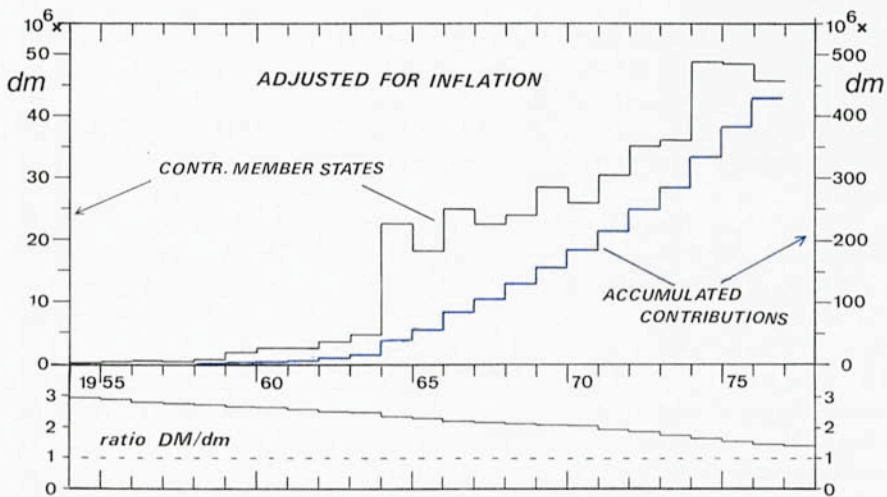

**FIGURE C. – Top part:** The black line shows the annual contribution of the member states over the first two decades since 1954, adjusted for inflation (i. e. expressed in the purchasing power of the Deutschmark of 1990). The blue line shows the accumulated contribution, i. e. the total of the contributions up to and including the year indicated at the bottom of the figure, and also adjusted for inflation; this line has been derived from the black one.

**Bottom part:** This line shows the gradual change of the ratio between the purchasing power of the Deutschmark at the year indicated, and that in 1990. These ratios were used for obtaining the top part of the figure.

Division and illustrate that it was responsible for the rapid increase of income and expenses in the early 1970's. Roughly speaking, TP Division expenses through 1976 concerned the 3.6-m Telescope with its building and dome, whereas in subsequent years emphasis shifted to auxiliary instrumentation as part of the regular running costs, and hence annual contributions and expenses then levelled off. Over the period 1971 to 1976 (the year of completion of the 3.6-m Telescope), the integrated expenditure of the TP Division amounted to DM 74 million. We saw that Ramberg's estimate of the year 1969 amounted to DM 39 million; adjusting this to 1975 for inflation would give about DM 52 million.

### Overall Developments Since 1954

In Figure C the black line shows the overall development of the annual contributions over the first two decades from 1954, and this time all figures

are in dm, i.e. adjusted to the 1990 purchasing power of the Deutschmark; the amounts are marked along the left-hand scale. We see that after 1964 there was a decade of approximately linear increase of the contributions followed by an extra growth around the completion of the large telescope, and subsequently levelling off when ESO's full operational stage had been reached.

The blue line shows the accumulated contributions, also in dm, and to be read along the right-hand scale. We infer that by the time the 3.6-m Telescope became operational, ESO had spent altogether about 400 million dm. Of these, the expenditure by the TP Division had been about 113 million dm, i.e. about 28%. A somewhat larger amount, about 150 million dm, 38%, had been spent up to 1970 when ESO's first phase had been concluded with the dedications on La Silla. 34%, or about one third, had been spent after 1969 on the operations and new construction programmes in Chile and on the services (including those for the Visiting Astronomers) at the (provisional) Headquarters in Hamburg-Bergedorf.



Gerhard Bachmann, Head of Finance, pondering about ESO's Finances?, at the FC's visit to La Silla of October 1971.

## REFERENCES AND NOTES

**Abbreviations used:**

- EHA = ESO Historical Archives. The numbers following EHA identify the (folder containing the) archival document according to the Inventory explained in Annex 1.
- FHA = Files belonging to the Office of the Head of Administration of ESO.
- EHPA = ESO Historical Photographs Archives.
- EC = ESO Committee, the Committee that preceded the Council.
- FC = ESO Finance Committee.
- IC = ESO Instrumentation Committee.
- OPC = Observing Programmes Committee.
- SPC = *before 1972*: Scientific Programmes Committee,  
*from 1972*: Scientific Policy Committee.
- ECM = ESO Committee Meeting.
- Heckmann Sterne = O. Heckmann, *Sterne, Kosmos, Weltmodelle*, Verlag Piper & Co., München, Zürich, 1976.

*Chapter 1*

- [1] For the text with authentic signatures, see EHA-I.A.1.1.
- [2] See EHA-I.B.1. for correspondence between Oort and the Dutch funding organization ZWO in preparation of Baade's stay.
- [3] I well remember Jan Oort one day entering my office – opposite to his at Leiden Observatory – to share with me his excitement about the idea!
- [4] The Memorandum on this meeting, later called ECM No. 1, is in the FHA; a copy of it in EHA-I.A.1.1.
- [5] For a report on the Conference see IAU Symp. No. 1, 1955, ed. A. Blaauw.
- [6] For the distribution of observatories in geographic latitude in 1954, see R. Coutrez and L. Bossy in *Ann. de l'Obs. R. de Belgique*, 3<sup>e</sup>Ser., Tome VI, 1954, quoted in J.H. Oort, *ICSU Review*, Vol. 3, No. 1, 1961.
- [7] ECM No. 2, Minutes (“Memorandum”) in EHA-I.A.1.1.
- [8] Memorandum on this meeting (ECM No. 3) is in the FHA; a copy of it in EHA-I.A.1.2.
- [9] A copy of this draft Convention is in EHA-I.A.1.2. It is marked “1st draft of Bannier and Funke” (in Dutch) in Oort's handwriting.
- [10] A copy of this draft is in EHA-I.A.1.11., with accompanying letter from Bannier to Blaauw.
- [11] Minutes in EHA-I.A.1.3.
- [12] EHA-I.C.1.1.g.
- [13] See ref. 12.
- [14] See ref. 12.
- [15] See ref. 12.
- [16] According to a letter of Blaauw to Hunter, EHA-I.C.1.1.g.
- [17] See letter of C.W. Borgmann, Ford Foundation, to J.H. Oort of October 2, 1959 in EHA-I.C.1.3.
- [18] See, for instance, Minutes of ECM No. 6, in FHA; a copy of it is in EHA-I.A.1.5.

- [19] In EHA-I.C.1.1.c.
- [20] page 6 of English version.
- [21] Heckmann Sterne, p. 265, 266.
- [22] *ESO Annual Report* 1964, p. 6.
- [23] Minutes ECM No. 12, p. 3 in EHA-I.A.1.11.
- [24] See ref. 23.
- [25] See, for instance, correspondence between Swings and Blaauw in March–April, 1961, in EHA-I.C.1.1.a.
- [26] EHA-I.C.1.1.c.
- [27] See Oort's report in a discussion by the Netherlands Astron. Council on 24 Sept. 1957, in EHA-I.C.1.1.c.
- [28] See ref. 27.
- [29] Minutes ECM No. 7, p. 8 in EHA-I.A.1.6.
- [30] Minutes ECM No. 9, p. 1 in EHA-I.A.1.8.
- [31] See EHA-I.C.1.1.c.
- [32] See ref. 31.
- [33] See ref. 31.
- [34] See ref. 31.
- [35] See letter by Oort to Heckmann of 13 February 1960 in EHA-I.C.1.1.d.
- [36] See EHA-I.C.1.1.c.
- [37] See ref. 36.
- [38] Undated copy in EHA-I.C.1.1.c.
- [39] See correspondence between Oort and Heckmann in May, June 1960, in EHA-I.C.1.1.d.
- [40] Undated letter of Oort to ESO Comm; January 1961? In EHA-I.C.1.1.c.
- [41] See correspondence between Oort and Heckmann in January–March, 1962, in EHA-I.C.1.1.d.
- [42] In EHA-I.A.2.5.
- [43] Heckmann Sterne, p. 267.
- [44] Circular letter by Fehrenbach of 23 January 1964 in EHA-I.C.1.1.c.
- [45] Circular letter by Bannier of March 27, 1963 in EHA-I.C.1.1.f.
- [46] Communication by the Dutch Ministry of Foreign Affairs of January 6, 1964 in EHA-I.A.2.5.
- [47] See ref. 46.
- [48] Communication Dutch Ministry of Foreign Affairs of May 9, 1968 in EHA-I.A.2.5.
- [49] See ref. 48.

## Chapter II

- [1] See the report on the site selection by W.H. Stevenson and H. Knox-Shaw in *Monthly Notices R. A. S.*, Vol. 95, p. 447, 1935.
- [2] In EHA-I.A.1.3. A paper presented at the Flagstaff Conference on Photoelectric Problems, Techniques, and Instrumentation, Aug.-Sept. 1952.
- [3] In EHA-I.A.1.3.

- [4] H. Siedentopf: *Climate of the Union of South Africa*, Astron. Inst. of the Univ. of Tübingen, 1955, in EHA-I. A. 1.3.
- [5] Memo of this meeting in EHA-I. A. 1.3.
- [6] A. Danjon and A. Couder, *Lunettes et Télescopes*, Paris 1935, Chapitre V. See also *Comptes Rendus* No. 183, 1032, 1926 for the calibrations.
- [7] Communications Obs. Royal de Belgique (Uccle), No. 141, 1958.
- [8] EHA-I. A. 1.3. A long report by Elsässer to Heckmann, Siedentopf and Unsöld accompanies this letter.
- [9] See EHA-I. A. 1.5. and I. B. 3.
- [10] See EHA-I. C. 2.3. a. and I. C. 2.3d.
- [11] IAU Symp No. 19, "Le Choix des Sites d'Observatoires Astronomiques (Site Testing)" Es. J. Rösch, G. Courtès and J. Dommangeat, p. 235, 1963.
- [12] See minutes of a discussion on 25 July 1958 following the 8th EC Meeting in EHA-I. A. 1.7.
- [13] See minutes EC Meeting of July 1958, item 13 in EHA-I. A. 1.7.
- [14] See letter of J.H. Oort to the EC of Oct. 21, 1958 in EHA-I. C. 2.3.
- [15] This report in EHA-I. B. 11. and I. C. 2.5. b.
- [16] See the minutes of this (12th) meeting of the EC. The report by Muller seems to be missing from the EHA.
- [17] In EHA-I. C. 2.5. d.
- [18] The report is contained in the minutes of the meeting.
- [19] In EHA-I. C. 2.2. a.
- [20] In EHA-I. B. 11.
- [21] See map EHA-I. A. 1.16.
- [22] EHA-I. C. 2.7. b., H. Siedentopf and F. Unz, Temperature Fluctuations in the Atmospheric Ground Layer observed at Zeekoegat and Flathill (South Africa), March 1964.
- [23] F. Unz, Mitteilungen Tübingen No. 116 = *Meteorol. Rundschau* 23, p. 87, 1970.
- [24] J. Dachs, U. Haug and J. Pfeleiderer, *Mitt. Tübingen* No. 87 = *J. Atm. Terr. Phys.* **28**, p. 637, 1966.
- [25] J. Pfeleiderer, J. Dachs and U. Haug, *Mitt. Tübingen* No. 88 = *Zeitschr. für Astroph.* **64**, p. 116, 1966.
- [26] In EHA-I. C. 2.7. b.
- [27] See letter van Geelen to Blaauw of 11 November 1960 in EHA-I. C. 2.8. d.

### Chapter III

- [1] See, for instance, Kuiper's report in *Lunar and Planetary Laboratory Communication* No. 156 of October 1970 in EHA-I. C. 2.7. b.
- [2] A copy of these reports is kept in EHA-I. C. 5.
- [3] See accounts by Stock in *Chile Site Survey Technical Report* No. 2, Kitt Peak Nat. Obs., 1963 in EHA-I. C. 2.7. b., and in *Information Bulletin Southern Hemisphere*, No. 7 Oct. 1965, Ed. J. Sahade.

- [4] I am indebted to Dr. F.K. Edmondson for informing me about these developments.
- [5] See Addendum C to the Minutes of the 2nd EC meeting of January 1954.
- [6] See page 5 of Stock's Report mentioned in Note [3].
- [7] These three letters in EHA-I.C.1.1.c.
- [8] These two letters in EHA-I.C.1.5.b.
- [9] In EHA-I.C.1.5.c.
- [10] The detailed report is in EHA-I.A.2.7.
- [11] In EHA-I.A.2.7., see also reports in EHA-I.C.1.5.f.
- [12] These two letters in EHA-I.A.2.8.
- [13] See EHA-I.A.2.8. for letters OH to FKE of August 26 and FKE to OH of September 3, 1963.
- [14] See minutes of the discussion in EHA-I.A.2.8.
- [15] See, for instance, G.W. Preston's account "That Special Mountain", Carnegie Inst. of Washington, May 1986.
- [16] EHA-I.A.2.8.
- [17] Communicated by F.K.E. to the author.
- [18] In EHA-I.A.2.8.
- [19] The full title reads: Convenio entre el Gobierno de Chile y la Organización Europea para la Investigación Astronómica del Hemisferio Austral, para el Establecimiento de un Observatorio Astronómico en Chile. See the volume *ESO Basic Texts*.
- [20] For reports on these meetings see EHA-I.C.2.7.a.
- [21] H. Siedentopf, Comparison between South Africa and Chile. *ESO Bulletin* No. 1, p. 11, 1966.
- [22] Heckmann Sterne, p. 288.
- [23] In EHA-I.A.2.8.
- [24] See notes by Oort and the telephone bill in EHA-I.A.2.8.
- [25] In EHA-I.A.2.8. and I.C.1.5.e.
- [26] EHA-I.A.2.8.
- [27] Communication by F.K. Edmondson to the author.
- [28] See EHA-I.A.1.22.
- [29] See EHA-I.A.2.8. as well as the minutes of the meeting prepared by AURA, in EHA-C.1.5.e.
- [30] See the letter of February 2, 1964 of Edmondson to Heckmann in EHA-I.A.2.8.
- [31] See, for instance, the minutes of the informal EC meeting on 20 January 1964, Council Doc no. 20 in FHA.
- [32] EHA-I.A.2.8.
- [33] EHA-I.A.2.10.
- [34] All four letters in EHA-I.A.2.8.
- [35] Heckmann Sterne, p. 290ff.

#### Chapter IV

- [1] Circular letter by Oort to EC members preparatory to the ECM of May 1959, in EHA-I.A.1.9., and minutes of that meeting.

- [2] See letters of Oort to Danjon and Funke of May 30, 1962, in EHA-I.C. 1.1.c.
- [3] In EHA-I.C. 1.1.d.
- [4] In EHA-I.C. 2.1.g.
- [5] See correspondence between ZWO and University of Groningen in the years 1962 and 1963 in EHA-I.C. 2.1.e.
- [6] Information provided by the Personnel Department of ESO; also: minutes of the ECM of July 1963, p. 12.
- [7] *Publ. Astron. Soc. of the Pacific* **72**, 225, 1960.
- [8] I.S. Bowen, *Publ. Astron. Soc. of the Pacific* **62**, 95, 1950.
- [9] I.S. Bowen, *Publ. Astron. Soc. of the Pacific* **61**, 243, 1949.
- [10] Jahresberichte Hamburger Sternwarte 1954 and 1955; *Sky and Telescope* **15**, Nov. 1955, p. 10.
- [11] See, for instance, minutes ECM of Oct. 1957, June 1961, Oct. 1962, Nov. 1963, Council Meetings of May 1964 and April 1966 and correspondence between Fehrenbach, Heckmann and Oort of June 1964 in EHA-I. A. 2.9. and I. A. 2.10.
- [12] Minutes ECM of April and Oct. 1957; the EHA do not contain the full report. A summary is attached to EHA-I. B. 3.
- [13] In EHA-I.C. 1.9.c.
- [14] In EHA-I.C. 1.9.a., Visite des Observatoires Américains.
- [15] Minutes ECM of November 1961.
- [16] See, for instance, the letter by Blaauw to Fehrenbach of April 6, 1961 in EHA-I.C. 1.9.c.
- [17] EHA-I.C. 1.9.c.
- [18] See letter by Minnaert to Oort and Blaauw of May 1, 1961 in EHA-I.C. 1.9.c.
- [19] See Minnaert's letter to Van Geelen of 10 October 1961 in EHA-I.C. 1.9.c.
- [20] Maps EHA-I.C. 1.9.f/k contain preparatory correspondence, technical descriptions, and the tender of Rademakers.
- [21] Minutes IC of November 1961.
- [22] See ref. No. 18.
- [23] Minutes ECM of June 1961.
- [24] Minutes ECM of November 1961.
- [25] EHA-I.C. 1.9.e. contains the Cahier de Charges with drawings and the Marché de Gré à Gré of REOSC of May 20, 1963.
- [26] In EHA-I.C. 1.1.c. See also correspondence between Fehrenbach and Oort of October 1958 in EHA-I. A. 2.1.
- [27] The Yale and U.S. Naval Observatories planned an instrument in Argentina and the Pulkovo Observatory one in Chile, whereas Greenwich Observatory contemplated a collaborative project with the Cape Observatory and Hamburg Observatory one with Perth.
- [28] Minutes Council Meeting of May 1964, p. 10.
- [29] Letter by Guinot to Blaauw and follow-up correspondence with Van Geelen in EHA-I.C. 1.9.d.
- [30] EHA-I. A. 1.19. and I. A. 2.6.
- [31] ESO Ann. Report 1965, p. 10.
- [32] *Astron. Journal* **74**, 954. 1969



*Chapter V*

- [1] EHA-I. A. 2.13.
- [2] Council Documents Chile-8, 12, 15, 16 in EHA-I. A. 2.14. and letters in EHA-I. A. 2.10.
- [3] Minutes Council Meeting 2–3 Dec. 1964 and *ESO Basic Texts* Section B3.
- [4] Cou. Doc. Chi-12 in EHA-I. A. 2.14.
- [5] See ref. 4.
- [6] Heckmann Sterne p. 298ff.
- [7] See Muller's reports mentioned before.
- [8] In EHA-I. A. 2.10.
- [9] EHA-I. C. 3.2.
- [10] EHA-I. C. 3.8.
- [11] Annual Report 1964.
- [12] Lists of employees were at regular intervals drawn up by the Administration in Bergedorf for the FC. For instance, they are found in doc. FC 32a and 32b for the situation per April 1, 1965 and in doc. FC 92 per Oct. 1, 1966; these documents are part of the FHA.
- [13] Cou. Doc. Chi-15 in EHA-I. A. 2.14; for preparatory work also Cou. Doc. Chi-9, 10 and 11.
- [14] EHA-I. A. 2.15.

*Chapter VI*

- [1] EHA-I.A.2.14.
- [2] Frank Middelburg became an ESO employee in 1967. By the time of his untimely death in the year 1985 he had become a specialist in the fields of image processing and software systems. See the obituary by A. Ardeberg in the *Messenger* No. 42 of December 1985.
- [3] See the ESO Annual Report for 1968.
- [4] A copy of this report occurs in the Oort Archives of the Leiden University Library; a duplicate from this has been put in EHA-I. A.1.18.
- [5] EHA-I. A.1.22.
- [6] Cou. Doc. Chi-7 in EHA-I. A.2.14. and minutes of the 2nd Cou Meeting.
- [7] Cou. Doc. Chi-12 and 14 in EHA-I. A.2.14. and letters of Heckmann to Oort of 4 and 13 Oct. 1964 in EHA-I. A.2.10.
- [8] ESO Basic Texts, Section B4.
- [9] See the sketches included in the Annual Report 1965.
- [10] See, for instance, Ann. Rep. 1968, p. 10. The realization of this telescope became part of the task of the ESO TP-Division.
- [11] See FHA File 2.9.2. The last one of the signatures was on Sept. 11, 1969, by the Chancellor of the Un. of Bochum.
- [12] See FHA File 2.9.3.
- [13] See Doc. Cou-205 of Nov. 7, 1975 in FHA File 2.9.3.

- [14] See Council Minutes December 1968.
- [15] "Problèmes posés à l'ESO par l'implantation sur ses terrains d'Instruments étrangers".
- [16] See Minutes 13th Cou Meeting, p. 12.
- [17] Cou-doc No. 55 of May 30, 1969 in FHA 1.1.1/1.2.1.
- [18] Details of the programme of the Council visit are in EHA-I.A.2.16. See also B.E. Westerlund's report in *Sky and Telescope*, Vol. 37, No. 6 of June 1969.
- [19] A.B. Muller, ed., *The Magellanic Clouds*, Astrophysics and Space Library, Vol. 23, Reidel Dordrecht 1971.

## Chapter VII

- [1] FHA Doc. ScAct-1.
- [2] FHA Doc. ScAct-2.
- [3] FHA Coc. ScAct-3.
- [4] For a short biography of B. Strömgren see, for instance, the obituary by M. Rudkjöbing in *Quarterly Journal R.A.S.* Vol. 29, p. 282, 1988.
- [5] See the report by Blaauw in *ESO Bulletin* No. 4 of July 1968.
- [6] See Minutes Cou Meeting, June 1970, p. 41.
- [7] See FHA Docs ScAct-4 and 5.
- [8] FHA Doc. ScAct-6.
- [9] See FHA Doc. ScAct-3 of June 1967.
- [10] Minutes 7th Cou Meeting, p. 29ff.
- [11] Strömgren's letter of Nov. 15 with accompanying Cou Letter 00/2426/68 of Ramberg, and Strömgren's letter of Nov. 20 with accompanying Cou Letter 00/2464/68 by Manager Bloemkolck, both in FHA Cou and FC Doc's 1.1.1./1.2.1., Circular Letters.
- [12] Letter marked 3137/69 in file FHA 1.1.1/1.2.1.
- [13] FHA Doc. Cou-2, 2283/69.
- [14] In FHA, attached to the Report of the Working Group referred to under reference [14].; an English translation was made at the request of Funke according to FHA 1.11/1.21, Cou-2 2321/69.
- [15] FHA Doc. Cou-2 3304/69.
- [16] We note that in the W. Group's report the GPO is not considered as one of the three middle-size telescopes of the Convention, contrary to the decision taken by the ESO Committee in July 1960 as reported in article IV.
- [17] See, for instance, FHA Doc. Cou-2 3309/69.
- [18] EHA-I.C.7.; not yet subclassified in December 1989.
- [19] In Europhysics News, *Bull. of the Eur. Phys. Soc.*, Vol. 6, No. 12, Dec. 1975, p. 3-5.
- [20] A report on this meeting by S.R. Pottasch is in the section Earliest Developments of the Archives.
- [21] The Archives contain the relevant correspondence of D.H. Sadler and F. Graham Smith with J.H. Oort and S.R. Pottasch of October 1967, and the report of the R.A.S. Working Group for study of the matter.
- [22] See minutes of this meeting and Doc. FHA Cou-2 CL 2399 of Nov. 14, 1968.

*Chapter VIII*

- [1] Wykeham Publications Ltd., London–Winchester 1975.
- [2] Heckmann Sterne, p. 323.
- [3] For reports on work by Baranne, Köhler, and Paul of the years 1962 and 1963, see EHA-I.C.1.9.m.
- [4] See page 118 of the Symposium Report.
- [5] FHA, Minutes 28th meeting of the IC, p. 9/10.
- [6] FHA, Doc. IC-26 = BG-16.
- [7] FHA, Doc. IC-18 = BG-15.
- [8] FHA, Doc. IC-24.
- [9] For reports of these meetings, see FHA Docs. IC-27 and IC-29.

*Chapter IX*

- [1] I am indebted to Mrs. Helga Schmal, associated with the Council Secretariat of CERN, for providing me with data on the membership of the CERN Council and Finance Committee over the years 1960–1973, and to ESO's librarian Edith Sachtchal for her intermediary in this matter.
- [2] In FHA, Section 1.1.1./1.2.1., Circular Letters Council and FC.
- [3] In FHA, Letter 00/3217/69 in File Cou-2, FC-2.
- [4] According to a note in the author's diary for 1969; no written report is left of this meeting.
- [5] Copy of this letter in EHA-I.C.5.
- [6] FHA-Cou Documents.
- [7] FHA-Cou Documents.
- [8] The letter is quoted in full in the minutes of the meeting, contained in FHA.

*Chapter X*

- [1] I am indebted to Prof. U. Haug of Hamburg Observatory for providing me with the references [2] and [3] below.
- [2] Abhandlungen Hamburger Sternwarte Band X, Heft 2, p. 50, 1979.
- [3] See O. Heckmann, in *Nature*, Vol. 76, p. 805, 1955 and in *Mitteilungen Astron. Gesellschaft* 1955, p. 57, 1956.
- [4] See Fehrenbach's report in the minutes of the 9th meeting of the Instr. Comm., Oct. 18, 1963, p. 10 in FHA. Reference is also made to the minutes of the EC of Nov. 1961, Oct. 1962, in FHA, and to the ESO Annual Rep. 1964.
- [5] Minutes of the 6th meeting of the Instr. Comm., p. 3, in FHA.
- [6] Minutes Instr. Comm. June 25, 1964, p. 7, in FHA.
- [7] Minutes of the 13th meeting of the Instr. Comm., p. 4; Minutes 2nd Cou Meeting, May 1964, both in FHA.

- [8] See also, in EHA-I.A.2.10, relevant correspondence between Oort and Heckmann in June and July 1964 and March 1965.
- [9] Proceedings of the Conference on "The Role of Schmidt Telescopes in Astronomy", Ed. U. Haug, published jointly by ESO, SRC and Hamburg Observatory, 1972, p. 137–139.
- [10] A more extensive description is in the minutes of the Instr. Comm. of March 1964, in FHA.
- [11] Editions du Centre National de Recherche Scientifique, Paris 1990, p. 404.
- [12] See ESO Annual Reports 1964–1966 and minutes Cou Meetings 1965 and 1966, in FHA.
- [13] FHA-Cou minutes Dec. 1968, p. 4.
- [14] Heckmann *Sterne*, p. 216 and 321–322.
- [15] In a letter of January 10, 1990, Prof. U. Haug of Hamburg Observatory points out to me, that in the case of the Hamburg Schmidt, whereas Strewinski was responsible for the mechanical design of the mounting, the combination optics-telescope tube was primarily handled by Zeiss-Jena, including a solution for the alignment telescope-tube/guiding-telescopes.
- [16] Ref. [2], p. 79.
- [17] "Astronomy With Schmidt Telescopes", Ed. M. Capaccioli, Reidel, 1983, p. 13.
- [18] *Mitteilungen Ver. Drehbank-Fabriken* No. 15, March 1958, p. 1, in EHA-III.
- [19] According to a letter by D. Shane to J.H. Oort of August 22, 1960; in EHA-I.A.1.13.
- [20] See note [9].
- [21] Documentation pertaining to the development of the ESO-SRC collaboration is contained in FHA-2.8.3, "Cooperation with SRC", including copies of correspondence between West, Blaauw and Reddish and the legal advisors of ESO and SRC from April 20, 1972 and draft texts for the Agreement from November 1972 till the final version of January 1974.
- [22] See, for instance, the internal Memo ref. SK/74/186/RW/FP of October 10, 1974 from West to various ESO Officers: "List of plates which have been distributed" in EHA-III.
- [23] *Uppsala Astron. Obs. Ann.*, Vol. 6, 1973.
- [24] I am much indebted to Prof. E. Holmberg and Dr. A. Lauberts for providing me with copies of the early correspondence in the files of Uppsala Observatory: letters of May 27 and Sept. 26, 1973. The ESO FHA-2.8.6. contain, for the period reported here, copies of correspondence and drafts as well as the final contract, beginning Sept. 26, 1973. See also the ESO Annual Reports.
- [25] E.B. Holmberg, A. Lauberts, H.-E. Schuster and R.M. West, the ESO/Uppsala Survey of the ESO (B) Atlas of the Southern Sky. I., in *Astron. Astrophys. Suppl* **18**, p. 463–489, 1974.

## Chapter XI

- [1] FHA Doc. Cou-62, Minutes 14th Cou Meeting, p.16.  
 [2] See Ref. [1], p.10.

- [3] FHA Doc. Cou-96, Minutes 17th Cou Meeting, p.31.
- [4] See, for instance, the minutes of Cou and FC over the years 1971–1973.
- [5] This proposal served for discussion in closed session at the 2nd meeting of the SPC and is not in the FHA. Its contents is reported in the minutes of this meeting, Doc. SPC-2 in FHA.
- [6] See, for instance, the compilation “Publications based on observational work at the ESO Observatory La Silla”, of Nov. 1974, Doc. OPC-20 in FHA-Sc.Act.
- [7] Minutes of this meeting with attached report of Chairman SPC to C. of Cou., Doc. Cou-121rev. in FHA.
- [8] See Doc. Cou-126 of Oct. 20, 1972 in FHA.
- [9] FHA Doc. Cou-127, Minutes of C. of Cou.
- [10] FHA Doc. Cou-126rev.
- [11] FHA Doc. Cou-131, Summary 20th meeting of Council; see also discussion of this topic in minutes 21st Cou meeting, Doc. Cou-149.
- [12] Report Chairman SPC and Minutes C. of Cou., Docs. Cou-145 and Cou-136 in FHA.
- [13] FHA Doc. Cou-142.
- [14] FHA Doc. Cou-149, Minutes 21st Cou. meeting.
- [15] See Ref. [9].
- [16] FHA Doc. Cou-147, Minutes 8th meeting C. of Cou., p.9.
- [17] FHA Doc. Cou-150, p.7.
- [18] FHA Doc. Cou-162, Minutes 22nd Cou. meeting, p. 21–23.
- [19] FHA Doc. Cou-175, Minutes 23rd Cou. meeting.
- [20] Proceedings of the ESO/SRC/CERN Conference on Research Programmes for the New Large Telescopes, Ed., A. Reiz, 1974.
- [21] FHA Doc. Cou-179, Minutes 12th meeting C. of Cou., p.2
- [22] FHA Doc. FC-246 and Cou-115.
- [23] FHA Doc. Cou-119, Minutes 19th Cou. meeting, p.11.
- [24] FHA Docs Cou-131 and Cou-135, Summary of Conclusions and Minutes 20th Cou. meeting.
- [25] FHA Doc. Cou-142 and discussion by president SPC in C. of Cou. in May 1973, see Doc. Cou-147.
- [26] FHA Doc. Cou-150, p.8.
- [27] FHA Doc. Cou-162.
- [28] FHA Doc. Cou-175.
- [29] EHA-I.B.8.
- [30] Monatsberichte Deutsche Bundesbank, Statistische Beihefte, Mai 1989, No.2.
- [31] Statistisches Bundesamt, Fachserie 17, Reihe 7, Preise und Preisindizes . . . (November 1990).
- [32] Minutes 2nd meeting Provisional Finance Comm. in FHA.
- [33] Docs FC-44,45 in FHA.
- [34] EHA-I.A.1.5. and I.B.3.
- [35] EHA-I.A.2.17. and I.B.7.
- [36] Minutes of the 9th meeting of F.C., Doc. FC-102 in FHA.

## ANNEXES

## THE ESO HISTORICAL ARCHIVES (EHA)

In the course of the year 1988, first steps were taken for the creation of the archives of historical documents at ESO Headquarters at Garching, on which most of the account in this book is based. At that time, some quite valuable collections of documentation pertaining to the earliest decades of ESO had become available. They originated from persons who had been intimately involved in the creation of ESO. A global inventory of these archives, showing only principal subdivisions is given on page 254. The more refined inventory as mentioned in the references in this book may be expected to become available to external investigators in due time.

For the arrangement and numbering I chose a system identifying the origin of the documentation and a structure that should allow in a natural way the future incorporation of documents from other sources. The system discriminates first of all between early contributions originating from outside ESO, category I, and those from within ESO, category II. Category III has been added in the course of the preparations for this book. Category I.A refers to documents originally belonging to J.H.Oort, category I.B to those from the Dutch organization ZWO, and category I.C to those transferred from archives kept until 1988 by the author. Hopefully, new categories I.D, I.E etc of this nature may follow.

A most important source of historical information are also the files of the Head of Administration (FHA) at ESO Headquarters that were generously made accessible by him to me. As the historical account progressed from the events of the 1950's and early 1960's to those of the late 1960's and 1970's, usage gradually shifted from the EHA to the FHA.

For the source of the illustrations in this book, frequent reference is made to the collection of photographs at ESO Headquarters that was freely put at my disposal. They are partly the result of a request directed in the past by ESO to ESO staff and early users of ESO's facilities. Although no systematic classification system for these photographs was available yet for the purpose of this book, in the later chapters I did refer to the collection as the EHPA (ESO Historical Photographs Archives).

## ESO HISTORICAL ARCHIVES

### Global Inventory per March 1991

#### I. DOCUMENTS RECEIVED FROM OUTSIDE ESO

##### I.A. Archives J.H.Oort

I.A.1. Documents donated by J.H.Oort to L.Woltjer

I.A.2. Documents donated by J.H.Oort to A.Blaauw

I.B. Archives J.H.Bannier; documents donated by the Dutch Organization ZWO pertaining to the Directorship of J.H.Bannier of this Organization

##### I.C. Archives A.Blaauw

I.C.1. Documents pertaining to the Secretariat of the ESO Committee (the committee that preceded the Council), with the exclusion of documents concerning the site-testing expeditions

I.C.2. Documents pertaining to the Secretariat of the ESO Committee, concerning the site-testing expeditions

I.C.3. Documents concerning the Working Group for Buildings, 1963-1965

I.C.4. Other documents prior to 1968

I.C.5. Documents pertaining to the Scientific Directorship, 1968-1969

I.C.6. Documents pertaining to the General Directorship, 1970 through 1974

I.C.7. Documents pertaining to the Chairmanship of the Board of Directors of the Journal Astronomy and Astrophysics, 1967-1979

#### II. DOCUMENTS ORIGINATING FROM INSIDE ESO

II.A. Documents from file marked "ESO Allgemein", 1961-1964

II.B. Documents from file marked "Seeing Chile vom 1 Jan. 1964"

#### III. DOCUMENTS AND CORRESPONDANCE INCORPORATED IN THE COURSE OF WRITING THIS HISTORICAL ACCOUNT, 1988-1991.



## The Ford Foundation and the European Southern Observatory

FRANK K. EDMONDSON, *Indiana University, U.S.A.*

The Ford Foundation supported projects around the world and expanded its activities to include science and engineering after Henry Heald became President of the Foundation in 1956. Carl Borgmann, President of the University of Vermont, was hired in 1958 to be the Director of the new Programme in Science and Engineering. Four large grants to support major astronomical programmes in the southern hemisphere were made during the period from late 1959 to early 1967. The Ford Foundation was restructured in March 1967 by Heald's successor, McGeorge Bundy, and the Programme in Science and Engineering was discontinued. Borgmann served as Advisor on Science and Technology until he retired in 1970.

Oort and Lindblad met with Heald and Borgmann on October 9, 1958 to discuss possible Ford Foundation support for the European Southern Observatory. Oort had written to the Ford Foundation in August 1956 but then received a negative reply. Little encouragement was given during the 1958 meeting, but a year later the Ford Foundation Board of Trustees approved an appropriation of \$ 1.0 million to be granted if three conditions were met. The first condition was that at least four of the five nations (Belgium, France, German Federal Republic, the Netherlands and Sweden) must sign the Convention to create ESO. The other two conditions were administrative. Borgmann wrote to Oort on October 2, 1959 to inform him about this action.

Shepard Stone, the Ford Foundation's Director of International Programmes, went to Paris three weeks after the \$ 1.0 million had been appropriated. He discussed the matter with Jean Monnet, the closest advisor to the Finance Minister, Pinay. Stone's personal friend Gaston Berger, who was Director of Higher Education, wrote in October 1959 a memorandum in French for Stone's signature. Monnet personally delivered it to Pinay, who presumably discussed it with De Gaulle. The French government decided to participate, and this was announced on June 28, 1960.

The \$ 1.0 million grant was paid in full on September 16, 1964. This grant was later used to buy the quartz blank for the 3.6-metre telescope.

The great importance of the \$ 1.0 million appropriation by the Ford Foundation cannot be overestimated. The Ford Foundation's promise of a \$ 1.0 million grant was the "catalytic agent", a term used in the Ford Foundation staff's recommendation, that persuaded the French government to join in creating ESO. Without it, ESO might never have been more than the dream of Baade and Oort.

The three other grants were: Yale-Columbia astrograph in Argentina, \$ 750,000 in 1960; CSIRO for Australian Radioheliograph, \$ 550,000 in 1962, and \$ 80,000 in 1966; AURA for half the cost of the Cerro Tololo 4-metre telescope, \$ 5,000,000 in 1967.

I wish to thank the Ford Foundation for giving me access to the archives for the four grants in Astronomy, and Eldon Jones and Ann Newhall for their assistance in using these archives.

## LIST OF MEETINGS OF THE ESO COMMITTEE (PRECEDING THE ESO COUNCIL)

No.	Date	Place	Chairman	Minutes made by:	Reference in ESO Hist. Archives
1	1953 June 21	Leiden	J. H. Oort	P. Th. Oosterhoff	I.A.1.1.
2	1954 January 25-27	Leiden	B. Lindblad	P. Th. Oosterhoff	I.A.1.1.
3	1954 November 8-9	Paris	J. H. Oort	P. Th. Oosterhoff	See FHA*
4	1956 April 20-21	Bergedorf	O. Heckmann	W. Fricke + O. Heckmann	I.A.1.3.
5	1956 October 15-16	Saltsjöbaden	B. Lindblad	P. Th. Oosterhoff	I.A.1.4.
6	1957 April 1-2	Uccle	P. Bourgeois	B. G. Hooghoudt	See FHA*
7	1957 October 28-29	Leiden	J. H. Oort	J. H. Bannier	I.A.1.6.
8	1958 July 23-24	Paris	J. H. Oort	J. H. Bannier	I.A.1.7.
9	1958 Oct. 31 - Nov. 1	Uccle	J. H. Oort	J. H. Bannier	I.A.1.8.
10	1959 May 29-30	Noordwijk a/Zee (Neth.)	J. H. Oort	A. Blaauw	I.A.1.9.
11	1959 July 4	Paris	J. H. Oort	A. Blaauw	I.A.1.10.
12	1960 July 15-16	Heidelberg	J. H. Oort	A. Blaauw	I.A.1.11.
13	1961 January 3-4	Paris	J. H. Oort	A. Blaauw	I.A.1.12., 13.
14	1961 June 12-13	Tübingen	J. H. Oort	A. Blaauw	I.A.1.14.
15	1961 November 6-7	Paris	J. H. Oort	A. Blaauw	I.A.1.15.
16	1962 March 5-6	Paris	J. H. Oort	A. Blaauw	I.A.1.16.
17	1962 June 18-19	Bruges	J. H. Oort	A. Blaauw	I.A.1.17.
18	1962 October 19-20	Stockholm	J. H. Oort	A. Blaauw	I.A.1.18.
19	1963 February 5-7	CERN, Geneva	J. H. Oort	O. Heckmann	I.A.1.19.
20	1963 July 23-24	Amsterdam	J. H. Oort	O. Heckmann	I.A.1.20.
21	1963 November 15	Bonn	J. H. Oort	J. Ramberg	I.A.1.21.

\* FHA = Files Head of Administration of ESO.

## MEETINGS OF THE INSTRUMENTATION COMMITTEE, 1961–1969

No.	Date	Place	Chairman/President	Minutes made by
1	1961 January 3	Paris	O. Heckmann	J. Ramberg
2	1961 February 22–24	Obs. H.-Provence	Ch. Fehrenbach	G. Courtès?
3	1961 April 18–19	Paris	Ch. Fehrenbach	
4	1961 June 9–10	Tübingen	Ch. Fehrenbach	
5	1961	Paris	?	
6	1961 November 11–12	Bergedorf	O. Heckmann	J. Ramberg
7				
8	1962 June 16–17	Uccle	?	
9	1962 October 17–18	Stockholm + Saltsjö- baden	O. Heckmann	J. Ramberg
10	1963 January 29–30	Utrecht	Ch. Fehrenbach	J. Ramberg
11	1963 May 14–15	Paris	Ch. Fehrenbach	J. Ramberg
12	1963 October 1	Heidelberg	Ch. Fehrenbach	J. Ramberg
13	1964 March 11–12	Liège	Ch. Fehrenbach	J. Ramberg
14	1964 June 25–26	Bergedorf	Ch. Fehrenbach	J. Ramberg (Assistant Dir.)
15	1964 September 4	Hamburg	Ch. Fehrenbach	J. Ramberg
16	1965 January 18–19	Bergedorf	Ch. Fehrenbach	J. Ramberg
17	1965 May 18–19	Bergedorf	Ch. Fehrenbach	J. Ramberg
18	1965 December 2	Bergedorf	Ch. Fehrenbach	J. Ramberg
19	1966 January 18	Paris	Ch. Fehrenbach	J. Ramberg
20	1966 May 26–27	Obs. H.-Provence	Ch. Fehrenbach	F. Dossin
21	1966 October 12	Paris	Ch. Fehrenbach	F. Dossin
22	1966 November 23	Bergedorf	Ch. Fehrenbach	F. Dossin
23	1967 May 2	Bergedorf	Ch. Fehrenbach	F. Dossin
24	1967 December 18	Bergedorf	Ch. Fehrenbach	F. Dossin
25	1968 July 4–5	Bergedorf	Ch. Fehrenbach	A. Behr + S. Laustsen
26	1968 November 5–6	Bergedorf	Ch. Fehrenbach	A. Behr + S. Laustsen
27	1969 January 15–16	Bergedorf	Ch. Fehrenbach	A. Behr + S. Laustsen
28	1969 May 8	Bergedorf	Ch. Fehrenbach	A. Behr + S. Laustsen
29	1969 June 2	Nice	Ch. Fehrenbach	A. Behr + S. Laustsen

## MEETINGS OF THE INSTRUMENTATION COMMITTEE, 1970 – 1974

No.	Date	Place	President
30	1970 June 2	Hamburg	Ch. Fehrenbach
31	1970 December 1	Geneva	Ch. Fehrenbach
32	1971 March 8	Geneva	Ch. Fehrenbach
33	1971 September 21	Geneva	Ch. Fehrenbach
34	1972 March 28	Geneva	J. Borgman
35	1972 June 6	Geneva	J. Borgman
36	1972 October 3–4	Geneva	J. Borgman
37	1973 February 13–14	Geneva	J. Borgman
38	1973 October 3–4	Geneva	J. Borgman
39	1974 March 27–28	Geneva	J. Borgman
40	1974 October 15–16	Lyon	J. Borgman

## MEETINGS OF COUNCIL AND FINANCE COMMITTEE, 1964-1969

COUNCIL				FINANCE COMMITTEE			
No.	Date	Place	President	No.	Date	Place	President
1	1964 February 5-6	Paris	J.H. Oort	1	1964 February 6	Paris	J.H. Bannier
2	1964 May 26-27	Obs. Haute-Provence	J.H. Oort	2	1964 May 26	Obs. Haute-Provence	J.H. Bannier
3	1964 December 2-3	Hamburg	J.H. Oort	3	1964 July 7	The Hague	J.H. Bannier
4	1965 June 1-2	Stockholm	J.H. Oort	4	1964 November 17	Bergedorf	J.H. Bannier
5	1965 Nov. 30/Dec. 1	Hamburg	(B. Lindblad†) Chair- man, J.H. Oort	5	1965 June 1	Stockholm	J.H. Bannier
6	1966 April 1	Santiago de Chile	G.W. Funke	6	1965 November 11	Bergedorf	J.H. Bannier
7	1966 November 21-22	Hamburg	G.W. Funke	7	1966 March 31	Santiago de Chile	J.H. Bannier
8	1967 June 1	Hamburg	G.W. Funke	8	1966 June 28	Bergedorf	J.H. Bannier
9	1967 December 1	Hamburg	G.W. Funke	9	1966 November 15	Bergedorf	J.H. Bannier
10	1968 July 2-3	Brussels	G.W. Funke	10	1967 May 3	Bergedorf	J.H. Bannier
11	1968 December 3-4	Hamburg	G.W. Funke	11	1967 November 21	Bergedorf	J.H. Bannier
12	1969 March 22	Santiago de Chile	J.H. Bannier	12	1968 June 11	Bergedorf	J.H. Bannier
13	1969 June 16	Hamburg	J.H. Bannier	13	1968 November 19	Bergedorf	J.H. Bannier
14	1969 December 15-16	Hamburg	J.H. Bannier	14	1969 February 20	Bergedorf	K.F. Scheidemann
				15	1969 October 3	Bergedorf	K.F. Scheidemann
				16	1969 December 15	Hamburg	K.F. Scheidemann

## MEETINGS OF COUNCIL, COMMITTEE OF COUNCIL AND FINANCE COMMITTEE, 1970 - 1974

COUNCIL and COMMITTEE of COUNCIL				FINANCE COMMITTEE				
COU No.	C. of C. No.	Date	Place	President	No.	Date	Place	President
	1	1970 May 6	Hamburg	J. H. Bannier	17	1970 March 10	Hamburg	C. Zelle
15		1970 June 11	Hamburg	J. H. Bannier	18	1970 May 22	Hamburg	C. Zelle
16	2	1970 November 17	Hamburg	J. H. Bannier	19	1970 October 28	Hamburg	C. Zelle
		1970 December 9	Hamburg	J. H. Bannier				
17	3	1971 May 18	Hamburg	J. H. Bannier	20	1971 May 17	Hamburg	C. Zelle
		1971 June 9-10	Hamburg	J. H. Bannier				
	4	1971 November 12	Geneva	J. H. Bannier	21	1971 October 5, 6, 8	La Silla, Santiago	C. Zelle
18		1971 Nov. 30/Dec. 1	Hamburg	J. H. Bannier	22	1971 November 16, 17	Hamburg	C. Zelle
19	5	1972 May 19	Geneva	A. Alline	23	1972 April 11	Hamburg	C. Zelle
		1972 June 8-9	Geneva	A. Alline				
20	6	1972 October 31	Bergedorf	A. Alline	24	1972 October 17	Bergedorf	C. Zelle
		1972 November 17-18, 21, 24	Santiago, La Silla	A. Alline				
	7	1973 March 29	Paris	A. Alline	25	1972 December 18	Geneva	C. Zelle
21	8	1973 May 18	Geneva	A. Alline	26	1973 April 26	Bergedorf	M. Fehrm
		1973 June 5-6	Hamburg	A. Alline				
22	9	1973 November 28	Geneva	A. Alline	27	1973 November 12, 13	Bergedorf	M. Fehrm
		1973 December 13-14	Hamburg	A. Alline				
	10	1974 March 26	Geneva	A. Alline	28	1973 December 12	Bergedorf	M. Fehrm
	11	1974 May 9	Bergedorf	A. Alline				
23		1974 June 19, 20	Hamburg	A. Alline	29	1974 June 6	Bergedorf	M. Fehrm
24	12	1974 November 1	Amsterdam	J. H. Bannier	30	1974 October 31	Amsterdam	M. Fehrm
		1974 December 5-6	Hamburg	J. H. Bannier				

Meetings of the Scientific Programmes Committee, the Observing Programmes Committee and the Scientific Policy Committee\*  
1968-1974

SCIENTIFIC PROGRAMMES COMMITTEE (SPC)			SCIENTIFIC POLICY COMMITTEE (SPC)		
Chairman: B. Strömberg			Chairman: B. Strömberg		
No.	Date	Place	No.	Date	Place
1	1968 May 2	Bergedorf	1	1972 April 25	Copenhagen
2	1968 October 17	Bergedorf	2	1972 October 10	Bergedorf
3	1969 May 6	Copenhagen	3	1973 March 28	Paris
4	1969 November 10	Marseilles	4	1973 September 14	Copenhagen
5	1970 April 29	Bonn	5	1973 November 7	Paris
6	1970 November 11	Liège	6	1974 June 18	Bergedorf
7	1971 March 9	Geneva	8 <sup>1</sup>	1974 September 3	Trieste
8	1971 June 18	Paris	9	1974 December 4	Bergedorf
9	1971 November 23	Roden			
OBSERVING PROGRAMMES COMMITTEE (OPC)			SCIENTIFIC POLICY COMMITTEE (SPC)		
No.	Date	Place	Chairman: B. Strömberg		
10	1972 June 13	Bergedorf	Chairman		
11	1972 December 15	Heidelberg	P. Swings		
12	1973 May 24	Bergedorf	P. Ledoux		
13	1973 December 11	Bergedorf	P. Ledoux		
14	1974 June 17-18	Bergedorf	P. Ledoux		
15	1974 December 2-3	Obs. Haute-Provence	P. Ledoux		

\* By Council decision of June 9-10, 1971 the Sc. Progr. Comm. split into the Obs. Progr. Comm. and the Sc. Pol. Comm.; membership was appointed in the Cou meeting of Nov. 30/Dec. 1, 1971.

<sup>1</sup> In numbering the meetings of the SPC, the number 7 was erroneously skipped.

## SUBJECT INDEX

(Numbers in italics refer to pages with illustrations)

- Airstrip Pelicano 229  
Archives (Historical) of ESO 253, 254  
Astrolabe, see Telescopes  
Astronomy and Astrophysics Journal  
143–146  
Atlases, see Sky Atlas Projects  
AURA-ESO negotiations 49, 50, 53, 54,  
57, 58  
AURA-ESO “Summit Meeting” in Chile  
49, 50, 51, 52  
Banner procedure 238  
Building Programme 91–93  
Centre in Europe 134, 212–215, 218,  
221–224  
German offer 221, 222  
political aspect 224  
CEPAL 54  
CERN  
as a model for ESO, 7, 8, 169  
ESO-CERN Agreement for TP Division  
170, 171, 177–182, 178, 179  
ESO-CERN arrangement for Sky Atlas  
Laboratory 203  
Cerro Calan Observatory, see Telescopes:  
Astrolabe  
Cinchado (AURA) 45, 59, 61  
Cinchado-North (= La Silla) 45, 59  
Colloquium on Photometry (Roden, 1966)  
132  
Colloquium on Spectroscopy (Nice, 1969)  
132  
Committee of Council  
creation 143, 177  
list of meetings 259  
“Convenio”, agreement with Chile 54, 56,  
57  
Convention between ESO Member States  
first drafts 7, 8  
main features 8  
ratifications 18  
signing 18  
Initial Programme 8, 65  
Coopérants 132  
Cost estimates, see Financial develop-  
ments  
Council  
constitution 67  
list of meetings 258, 259  
membership 67  
Presidency 67, 258, 259  
visits to Chile 227, see also Dedications  
Danjon Telescope 24, 33, 38  
Dedications in Chile  
1966, Road on La Silla 83, 98, 99  
1969, First phase of constructions  
100–102, 102, 118, 119, 120, 121  
1969, Symposium on Magellanic Clouds  
122  
Directorate  
Heckmann first Director 65, 66  
Heckmann Director General 123  
Ramberg Assistant Director 66  
Ramberg Technical Director 124  
Bloemkolk Manager 66  
Blaauw Scientific Director 124  
Restructuring per January 1968 123, 124  
Westerlund Director for Chile 124  
El Gigante 60

- Emblem 81
- ESO Bulletins 37
- ESO Committee (predecessor of Council)
  - chairmanship 7, 256
  - creation 6
  - table of meetings 256
- ESRO 171
- Finance Committee
  - list of meetings 258, 259
  - membership 67
  - Presidency 68, 258, 259
  - status 67
  - visit to Chile 220, 223
- Financial developments 232–240, 234, 237, 238
  - annual contributions 234, 236–238
  - cost estimates 6, 138, 234–236
- Ford Foundation Grant 10, 11, 12, 255
- Founding Fathers 12, 13
- Geographical dispersion in Chile 225–229
- Guesthouse 96, 98, 215
- Guatulame 45, 59, 60
- Headquarters in Europe, see Centre in Europe
- Headquarters in Santiago 219
  - planning 106, 108, 110, 225
  - Vitacura donation 111
  - construction 112, 121
- Inauguration, see Dedications
- Initial Programme of Convention, see Convention
- Instrumentation (see also under Telescopes)
  - early planning 69, 70, 72–74
- Instrumentation Committee (IC)
  - creation 70
  - list of meetings 257
  - Presidency 70, 257
- Klavervlei Site 22, 26, 29, 31
- La Peineta 46, 48
- La Silla
  - acquisition 85
  - choice 45, 58, 59, 62, 63, 63
  - earliest developments 83–90, 89, 93–95, 96, 97
  - developments 1967–1969 103–106, 107, 109, 114
- Logo, see Emblem
- Magellanic Clouds Symposium see Dedications 1969
- Membership, see Convention: ratifications
- Magellanic Clouds, Symposium 122
- Mining Rights 90, 91
- National Telescopes, see Telescopes
- Observing Programmes Committee (OPC)
  - 213, 260
- Paranal 47
- Pelicano camp 90, 92, 228
- Photometric Telescope, see Telescopes
- Restructuring in Chile, see Geographical Dispersion
- Road on La Silla 83, 86, 88–90, 89
- Schmidt Telescope, see Telescopes
- Science Research Council (British) 203, 205
- Scientific Activities 211
  - early activities 124, 129
- Scientific Policy Committee (SPC from 1972)
  - creation 213
  - list of meetings 260
- Scientific Programmes Committee (SPC until 1972)
  - creation 126, 127, 127
  - list of meetings 260
- “Seeing” measures 21



- Site Tests, evaluation 55
- Site Tests in Chile 43–49, 45–47
  - Stock's Explorations 43
  - Muller and McSharry 48–49
- Site Tests in South Africa 19–42, 22, 33
  - Comprehensive Programme 31–34
  - Comprehensive Report 38, 39
  - First explorations 23–25, 24
  - Marseilles Project 25, 30, 35, 38
  - Quick Look Expedition 27
  - Siedentopf Experiment 34, 35
  - Tübingen Project 35, 31, 36
- Sky Atlas Laboratory 200–203, 201, 202, 204
- Sky Atlas Projects
  - Quick Blue Survey 203
  - ESO-SRC Atlas 205–207
  - ESO-Uppsala Faint Galaxies Survey 208, 209
  - Soul-searching on ESO's tasks 139–143
  - Spectrographic Telescope, see Telescopes
  - Stamp showing la Silla 230, 231
  - Statement of Intent 1, 2, 3, 6
  - Telescopes
    - Early conferences and texts on telescopes 148
    - Hale 5-m Telescope 158
    - Lick 3-m Telescope 156, 157
    - Mayall 4-m Telescope 159
    - Astrolabe 80, 216, 217
    - Grand Prism Objectif (GPO) 78–80, 128
    - 50-cm Copenhagen 112, 115, 144
    - 50-cm ESO 112, 145, 145
    - 60-cm Bochum 112–115, 140
    - 1-m Photometric 74–76, 75, 113, 130, 131
    - 1.5-m Spectroscopic 76, 78, 77, 135, 136, 137
    - 1.5-m Danish 115
    - Schmidt 187–200, 199
      - optics 188–191, 188, 193
      - design and construction 192–195, 194, 196, 198, 200
    - 3.6-m 147–168, 171–185
      - automation in control 167, 168
      - building and dome 166, 167
      - mirror cells 154
      - optics 149–154, 151, 152, 153, 155
      - stagnation in progress 162–165
      - tube and mounting 155–162, 161, 164, 165
    - In-House Development Group 173–177
    - Telescope Project Division at CERN 169–171, 177–185
  - National telescopes, basic considerations 112, 118, 119
  - New telescopes Programme 134–138
  - Visiting astronomers
    - rules 126
    - allocation of observing time 133, 134
  - Working Groups
    - for buildings 91
    - for operation Observatory 124, 126
    - for scientific programming 126
    - for reviewing Programme, Administration Procedures and Staff Problems 139, 143
- Zeekoegat Site 22, 26, 28, 30

## NAME INDEX

(Numbers in italics refer to pages with photographs)

- Allende, S. 227  
Alessandri, J. 57  
Alline, A. 139, 143, 165, 169, 225, 227, 259  
Amaldi, E. 178  
Anguita, C. 80, 119  
Anthunesz, N. 125  
Ardeberg, A. 132, 133  
Baade, W. 4, 5, 6, 13, 20, 156, 189  
Bachmann, G. 180, 240  
Bachmann, Mrs 180  
Bahner, K. 148, 154  
Banner, J. H. 4, 7, 10, 13, 32, 66–69, 68,  
71, 81, 100, 101, 102, 118, 139, 169,  
171, 178, 232, 238, 254, 256, 258, 259  
Baranne, A. 78, 148, 150, 151, 154, 160  
Barlow, B. V. 148  
Bauersachs, W. 167  
Baustian, W. W. 148  
Bayen 79  
Bayle, A. 78, 155  
Bechmann, E. 229  
Behr, A. 76, 133, 154, 160, 180, 188, 193,  
257  
Behr, Mrs 180  
Beintema, D. 32  
Berger, G. 16, 255  
Berniard, P. A. 223  
Bertiau, F. 23  
Biermann, L. 213, 221  
Bilius, G. 32  
Blanco, V 121  
Blichfeldt, M. 168, 173  
Bloemkolk, J. 66, 139, 143, 170, 180, 181  
Bloemkolk, Mrs 181  
Bok, B. J. 9, 20, 40  
Bondi, H. 171  
Borgman, J. 73, 74, 76, 127, 132, 221, 257  
Borgmann, C. W. 11, 255  
Bosker, A. 30, 32, 40, 95, 116, 229  
Boulloche 16, 24  
Boulon, J. 23  
Bourgeois, P. 1, 3, 4, 6, 20, 71, 256  
Bowen, I. S. 72, 148, 150  
Braes, L. L. E. 146  
Breysacher, J. 132  
Briggs, J. A. 98  
Brunet, J. P. 129  
Buchroeder, R. 204  
Bundy, McGeorge 255  
Cannon, A. 208  
Carrasco, H. 93  
Carozzi, N. 79  
Cayrel, R. 126  
Castello, O. 89  
Colin, J. 132  
Couder, A. 1, 3, 21, 23, 26, 30, 44, 70, 152,  
160  
Courtès, G. 23, 148, 257  
Coutrez, R. 70  
Crawford, D. L. 148  
Dachs, J. 35, 115  
Danesin, M 184  
Danjon, A. 1, 3, 4, 6, 12–16, 13, 18, 20,  
21, 23, 25, 26, 44, 47, 79, 80  
Danjon, P. 13  
de Gaulle, Ch. 255  
de Groot, M. 223  
Delhayé, J. 127  
Deloz, M. 68, 71  
de Vlaming, F. W. 84, 92, 111  
de Vries, M. 76, 116, 127, 130, 133  
Dommanget, J. 23, 25, 34  
Doornenbal, J. 32, 40, 75, 95, 116, 131,  
135

- Dossin, F. *104, 129, 132, 141, 167, 257*  
Dossin, Mrs S. *141*  
Dufлот, A. *79*  
Dufлот, M. *79*  
Dumont, H. *223*  
Dumoulin, B. *201, 202*  
Edmondson, F. K. *12, 49, 51, 52, 52-54, 57-59, 62*  
Eggen, O. J. *10*  
Elsässer, H. *23, 148*  
Espiard, J. *150, 151*  
Euler, C. *95*  
Evans, D. *41*  
Evans, mrs M. *41*  
Fehrenbach, Ch. *4, 13, 14, 16, 23, 25-27, 28, 30, 34, 37, 49, 51, 52, 58, 59, 62, 65, 66, 70, 71, 74, 76, 78, 79, 83, 92, 108, 148-150, 152, 155, 160, 162, 163, 167, 170, 192, 257*  
Fehrm, M. *259*  
Fierst van Wijnandsbergen, P. J. *223*  
Florsch, A. *79*  
Franz, H. *229*  
Frei Montalva, E. *101, 102*  
Fresno, J. F. *100, 101*  
Fricke, W. *71, 256*  
Fritsche, C. *98*  
Fritsch, H. *98*  
Funke, G. *7, 13, 67, 68, 71, 98, 139, 165, 169, 170, 225, 258*  
Geier, H. *220, 223*  
Geyer, E. *57, 124, 133*  
Grage, H. *223*  
Gregory, B. P. *170, 178, 182, 221*  
Grewing, M. *32*  
Gronbech, B. *229*  
Guinot, B. *23, 80*  
Haffner, H. *26, 28*  
Hampton, G. *170, 178*  
Haro, G. *72*  
Hauck, B. *146*  
Haug, U. *31, 35, 133, 205*  
Heald, H. *255*  
Heckmann, Mrs J. *60, 67, 104, 118, 196*  
Heckmann, O. *1, 3, 4, 6, 7, 9, 11, 14, 17, 18, 20, 23, 34, 43, 44, 49, 50, 51, 52, 53, 54, 56-59, 60, 62, 63, 65, 66, 68, 70, 71, 74, 75, 79, 81, 83, 84, 84, 88, 91, 100, 101, 102, 108, 113, 118, 120, 123, 124, 126, 139, 148, 149, 150, 155, 160, 162, 163, 165, 167, 170-172, 187, 189, 192, 194, 195, 196, 197, 235, 256, 257*  
Heilmeyer, E. *56*  
Heynekamp, Ch. E. *23*  
Hide, C. G. *42*  
Hiltner, W. A. *119*  
Hodge, W. *9*  
Holder, R. H. G. *95*  
Holmberg, E. *34, 127, 127, 208, 209*  
Hooghoudt, B. G. *26, 28, 69, 70, 72, 74, 75, 76, 191, 256*  
Hunter, A. *10*  
Hyslop, H. *120*  
Hyslop, Mrs. O. *120*  
Irwin, J. *64*  
Jones, H. Spencer *4, 6, 7, 20*  
Joxe *16*  
Kenneth, R. *184*  
Klingenberg, S. *95*  
Kopp, K. *31, 32*  
Köhler, M. *150, 151*  
Köster, R. *26, 42*  
Kourganoff, V. *7*  
Kuiper, G. P. *43, 148*  
Lacroute, P. *119, 124*  
Lallemand, A. *172*  
Laporte, H. *184*  
Lauberts, A. *209*  
Laustsen, S. *164, 167, 168, 173, 177, 184, 184, 257*

- Ledoux, P. 127, 213, 260  
 Lemaître, G. 150, 154  
 Leroy, E. 184  
 Lindblad, B. 1, 3, 4, 6, 7, 11, 13, 17, 67, 68, 71, 124, 255, 256, 258  
 Lindén, H. 32, 37  
 Lofthouse, T. 183  
 Lundmark, K. 1, 3  
 Lüst, R. 221  
 Lynds, B. 204  
 Malaise, D.J. 154  
 Malm, B. 168, 173  
 Malmquist, G. 1, 3  
 Maurice, E. 78, 129, 132, 141  
 Maurice, Mrs F. 141  
 Marchetti 51, 52  
 Marck, H. W. 66, 180  
 Mayer, U. 34, 35, 38, 39  
 Mayall, N. U. 49, 51, 52, 53, 57–59, 62, 72, 119  
 McSharry, P. 32, 34, 40, 48, 55  
 Meinel, A. B. 148  
 Mendoza, E. 129  
 Messerschmidt, D. 32  
 Middelburg, D. G. E. 103  
 Middelburg, Mrs 104  
 Middelburg, F. 103  
 Middelhurst, B. 148  
 Migeotte, M. 160  
 Miller, W. C. 201, 202, 203  
 Minkowski, R. 202  
 Minnaert, M. G. J. 72–74, 75  
 Monnet, J. 255  
 Monnet, G. J. 154  
 Mulder, R. 116  
 Muller, A. B. 19, 27, 30, 31, 32, 34, 37, 38, 40, 41, 48, 49, 51, 52, 55, 58, 59, 60, 61, 62, 63, 66, 71, 83–86, 84, 88, 90, 93–95, 98, 122, 124, 127, 130, 166, 192, 198, 200  
 Muller, Mrs L. 120  
 Naudé, S. M. 42  
 Nilson, P. 209  
 Noël, F. 80, 217  
 Obling, O. 169  
 Ojeda, S. 229  
 Oort, Mrs M. 11  
 Oort, J. H. 1, 3, 4, 6, 7, 9–12, 14–18, 15, 20, 23, 43, 44, 47, 49, 50, 51, 52, 52, 53, 57, 59, 62, 65–67, 68, 71, 72, 79, 84, 91, 99, 253, 253–256, 258  
 Oosterhoff, P. Th. 1, 3, 4, 256  
 Oosthuizen, M. E. Z. 26, 28, 42  
 Palisson, J. 116  
 Palme, O. 100, 101, 102  
 Parise 160  
 Pasten, P. 117  
 Patard, F. 201  
 Pecker, J.-C. 213, 221  
 Pesch, J. 35  
 Petri, S. 184  
 Petterson, L. 32  
 Pfeleiderer, J. 31, 35  
 Piganiol 16  
 Pillet, B. 201  
 Pinay 255  
 Pizarro, G. 198, 203  
 Pizarro, O. 198, 199, 203  
 Plentl, R. 95  
 Ponce, H. 229  
 Pot, G. M. 81  
 Pottasch, S. R. 145, 146  
 Prévot, L. 78, 129  
 Ramberg, J. 44, 66, 68, 70, 72, 75, 93, 110, 123, 124, 138, 139, 148, 159, 160, 163, 164, 167, 170, 172, 173, 180, 181, 193, 195, 236, 239, 256, 257  
 Ramberg, Mrs 181  
 Reddish, V. R. 204, 205  
 Redman, R. 1, 3, 9

- Reiz, A. 68, 71, 115, 145  
Rickard, J. J. 132, 141  
Rijken, B. 71  
Rohlf, K. 23  
Rösch, J. 58, 59, 61, 63, 68, 83  
Rouel, J. 184  
Rule, B. 193  
Sahade, G. 100, 101, 118  
Salm, H. 92  
Samuelsson, B. 223  
Schalén, C. 5  
Scharnweber, P. 173  
Scheidemann, K. F. 68, 139, 165, 225, 258  
Schlosser, W. 32  
Schmidt, B. 187, 189  
Schmidt-Kaler, Th. 112, 115  
Schorr, R. 187–189  
Schuster, H.-E. 93, 95, 116, 132, 141, 198, 203, 209, 223  
Schwarzschild, K. 187  
Seufert, W. 32  
Shane, D. 48, 72  
Siedentopf, H. 20, 23, 34, 35, 40, 49, 51, 55, 58, 71, 74, 105  
Simeon, A. 116  
Spite, F. 219  
Spite, M. 219  
Starischka, B. 56  
Steinberg, J.-L. 145, 146  
Stock, J. 34, 43, 44, 48, 49, 53–55, 59, 121, 129  
Stoltenberg, G. 119, 120  
Stone, S. 15, 255  
Stoy, Mrs M. 41  
Stoy, R. 4, 41  
Straatman, H. J. 95  
Strewinski, W. 69, 70, 148, 156, 157–165, 160, 169, 190–194, 198, 200  
Strömgren, B. 11, 115, 127, 127, 129, 134, 163, 213, 218, 221, 227, 260  
Stuit, T. 71  
Swings, P. 127, 260  
Texereau, J. 150, 151  
Traving, G. 127  
Triorial, J. 101  
Tripp, J. W. 23  
Ulff, C. 27  
Underhill, A. B. 132  
Unsöld, A. 1, 3  
Unz, F. 35, 89  
Urrizar Family 85  
Urrutia, A. 91  
Valdès, G. 100, 101, 102  
van der Ven, J. 75, 198  
van Geelen, B. 31, 32, 37, 71  
van Hoof, A. 124  
van Rhijn, P. J. 1, 3  
Villena, R. 105, 120, 121  
Villena, Mrs U. 120  
Voigt, H. O. 90, 95, 105  
von Krumhaar, H. 197  
Walraven, Th. 25, 127  
Walters, K. 54, 56, 68  
Weber, W. 32  
West, R. M. 200, 201, 202, 203, 205, 208, 209  
Westerlund, B. E. 122, 124, 127, 132, 141, 223, 226, 227, 228  
Westra, J. 127  
Whitford, A. E. 72  
Wildt, R. 53, 54, 57  
Wolf, B. 78  
Woltjer, L. 1, 218, 221, 224, 229, 253, 254  
Wood, H. J. 78  
Woolley, R. v. d. R. 9, 10  
Zelle, C. 169, 220, 223, 227, 259  
Zilverschoon, C. 71, 169, 170, 171





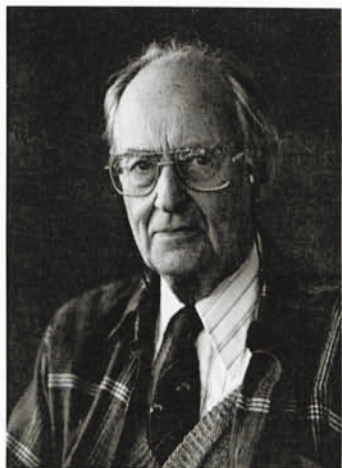

*Photograph: H.-H. Heyer*

This book tells the early story of the European Southern Observatory (ESO), the international organization for cooperation in European astronomy.

It begins in the early 1950's when leading European astronomers initiated the project and started a search for the best possible observatory site under the comparatively unexplored southern sky. In 1962, ESO was established by an international convention and a few years later a remote mountain top in the Chilean Atacama desert, La Silla, was acquired. It took another decade to transform this site into the world's largest optical observatory, now serving more than 2000 astronomers in eight member countries.

The story of ESO is that of a highly successful European integration in a fundamental field of science, providing European scientists with modern facilities for front-line investigations beyond the capacities of the individual member states.

The author is the well-known Dutch astronomer Professor Adriaan Blaauw, who has been closely associated with ESO during all of this time. He actively participated in many of the events described and as a former Director General of ESO (1970 – 1974) he possesses first-hand knowledge of the organization and the way it works. A scientist of international renown, Professor Blaauw is also a noted amateur historian in his home country.