



Crystalfontz America, Incorporated

CFA910 E Ink Module and Development Platform User Guide



Crystalfontz Model Number	CFA910
Hardware Version	Revision 0.3, November 2010
Firmware Version	Revision 0.5, November 2010
Data Sheet Version	Revision 1.0, November 2010
Product Pages	https://www.crystalfontz.com/products/product.phtml?product_id=1282

Crystalfontz America, Incorporated

12412 East Saltese Avenue
Spokane Valley, WA 99216-0357
Phone: 888-206-9720
Fax: 509-892-1203
Email: techinfo@crystalfontz.com
URL: www.crystalfontz.com



REVISION HISTORY

HARDWARE	
2010/11/01	Current hardware version: v0.3 New product.

FIRMWARE	
2010/11/01	Current firmware version: v0.5 Initial release.

USER GUIDE	
2010/11/11	Current Data Sheet version: v1.0 <ul style="list-style-type: none">● Added Illustrations with Dimensions (7 Pages) (Pg. 17).● Expanded information in Physical Characteristics (Pg. 15).
2010/11/05	Data Sheet version: v0.1 New Data Sheet.



The Fine Print

Certain applications using CrystalFontz America, Inc. products may involve potential risks of death, personal injury, or severe property or environmental damage ("Critical Applications"). CRYSTALFONTZ AMERICA, INC. PRODUCTS ARE NOT DESIGNED, INTENDED, AUTHORIZED, OR WARRANTED TO BE SUITABLE FOR USE IN LIFE-SUPPORT APPLICATIONS, DEVICES OR SYSTEMS OR OTHER CRITICAL APPLICATIONS. Inclusion of CrystalFontz America, Inc. products in such applications is understood to be fully at the risk of the customer. In order to minimize risks associated with customer applications, adequate design and operating safeguards should be provided by the customer to minimize inherent or procedural hazard. Please contact us if you have any questions concerning potential risk applications.

CrystalFontz America, Inc. assumes no liability for applications assistance, customer product design, software performance, or infringements of patents or services described herein. Nor does CrystalFontz America, Inc. warrant or represent that any license, either express or implied, is granted under any patent right, copyright, or other intellectual property right of CrystalFontz America, Inc. covering or relating to any combination, machine, or process in which our products or services might be or are used.

The information in this publication is deemed accurate but is not guaranteed.

Company and product names mentioned in this publication are trademarks or registered trademarks of their respective owners.

Copyright © 2010 by CrystalFontz America, Inc., 12412 East Saltese Avenue, Spokane Valley, WA 99216-0357 U.S.A.



CONTENTS

MAIN FEATURES	2
CFA910 MODULE PACKAGE CONTENTS	3
Vizplex E Ink Display	3
Main Board (CrystalFontz CFA10022)	4
Connectivity Interfaces	4
LEDs	6
Switches	6
SD Card Slots	6
OPTIONAL ACCESSORIES	7
Touchscreen	7
Expansion Board for Development and Debugging (MISC-CFA10032)	7
Connectivity Interfaces	7
Debug Console Serial Port (ttyS0 under Linux)	8
Two RS232 Serial Ports (ttyS1 and/or ttyS2 under Linux)	9
JTAG Hardware Debugging Interface	10
16 GPIO Pins	11
One SPI Port	12
TWI/I ² C	13
Various Voltage Test Points	14
MECHANICAL SPECIFICATIONS	15
Physical Characteristics	15
Overall Dimensions	15
Additional Physical Characteristics	16
Illustrations with Dimensions (7 Pages)	17
CFA910 MODULE BLOCK DIAGRAM	23
BUILD YOUR OWN APPLICATION	24
CARE AND HANDLING PRECAUTIONS	24
ESD (Electro-Static Discharge)	24
Design and Mounting	24
Avoid Shock, Impact, Torque, or Tension	25
Cleaning	25
Operation	25
Storage and Recycling	25
APPENDIX A: SCHEMATIC FOR MISC-CFA10032	26



QUICK START DEMOS

The CFA910 module is preprogrammed with two demonstration programs. Simply plug the power supply (included) into an AC outlet. The CFA910 will initialize and turn on the Vizplex E Ink display.

If your module does not have the optional touchscreen, plug in a USB keyboard to the USB host port on the Main Board (CrystalFontz CFA10022).

If your module has the optional touchscreen, you will be prompted to calibrate the touchscreen by touching a series of five crosshair symbols. In addition, you may plug in a USB keyboard.

Several icons will be displayed. To see the demonstrations, select the Demos icon.

The Demos folder contains two demonstration applications: *PDF Demo* and *Slideshow*.

1. Click/tap the *PDF Demo* icon to display an example of a Data Sheet for one of our LCD graphic modules.
2. Click/tap the *Slideshow* icon to display a series of images. To exit the *Slideshow*, push the middle switch (SW1) on the top edge of the Main Board or press the ESC.

To exit either application, click/tap the X in the upper right corner of the application's title bar or press CTRL+q.

To safely power down the module, click/tap the Other icon to open it, then click/tap on the Power-off icon. The splashscreen, which can be configured by the user, will remain displayed until the CFA910 is turned on again.

MAIN FEATURES

The CFA910 module is a convenient and very economical way for developers to work with an E Ink module (Vizplex E Ink display plus SBC (Single Board Computer) Main Board CrystalFontz CFA10022) running Linux OS. The display is an E Ink Holding Corporation's Electrophoretic Display (EPD), also known as e-paper. The compact module uses a powerful [Atmel AT91SAM9G45 ARM microprocessor](#). The firmware is completely customizable. You can build your own application for the CFA910 module using open source software. The CFA910 module is intended for users familiar with developing for the Linux operating system on an ARM platform.

Features include:

- 6" diagonal Vizplex E Ink display, high resolution (800 x 600 pixels) with high contrast 4-bit grayscale (16 shades of gray). The display can be used in landscape or portrait mode. The display has an antiglare hard-coated front surface.
- Display Active Area is 122.40 (W) x 90.60 (H) mm (4.82" (W) x 3.7 (H)" inches).
- An optional touchscreen is available at the time of purchase for a very low price.
- For development and debugging, you can buy the optional [MISC-CFA10032 Expansion Board](#).
- Overall size of the CFA910 module (E Ink display and Main Board CrystalFontz CFA10022):
 - *Without touchscreen*, nominal 137.90 mm wide x 105.10 mm high x 15.53 mm depth (5.43" wide x 4.14" x 0.61" depth).
 - *With touchscreen*, nominal 137.90 mm wide x 105.10 mm high x 16.53 mm depth (5.43" wide x 4.14" x 0.65" depth).



- ❑ Available interfaces are I²C, Logic Level Serial, RS232, SPI, and USB.
- ❑ Very low power: using E Ink technology and hardware suspend features, you can program the module to use very little power compared to traditional displays (including TFT and OLED modules).
- ❑ Epson Broadsheet EPD Display Controller.

CFA910 MODULE PACKAGE CONTENTS

The basic CFA910 module package contents are:

- ❑ CFA910 module, which is a Vizplex E Ink Display mounted on an SBC (Single Board Computer) Main Board (CrystalFontz CFA10022).
- ❑ 5 volt DC Adapter
- ❑ Six foot USB Cable (A to Micro B)
- ❑ MicroSD Card

VIZPLEX E INK DISPLAY

High Resolution Active Matrix Displays made with E Ink's Vizplex Imaging Film have a number of distinctive benefits over existing technologies. Commonly referred to as Electronic Paper Displays, EPD displays are reflective and can be easily read in bright sunlight or dimly lit environments while being able to be seen at virtually any angle - an experience that is just like paper.

The black and white ink-on-paper look, combined with a resolution in excess of most competitive display technologies, EPDs give the display an appearance similar to that of the most widely read material on the planet - newspaper. Because the display uses power only when an image is changed, E Ink displays have extended battery life over other types of displays. The unique technology also results in a compact and lightweight form factor making it ideal for highly portable applications. — from *E Ink Corporation*, http://www.eink.com/products/matrix/High_Res.html on 2010-11-02



MAIN BOARD (CRYSTALFONTZ CFA10022)

Connectivity Interfaces

The Main Board connectivity interfaces are:

1. One USB device/host port (H)
2. One USB host port (Full size A)
3. One 10/100 Ethernet port (RJ45 connector).
4. 70-pin expansion footprint that mates with a Samtec FSI-135-03-G-D-AD.

PIN	EXPANSION CONNECTION			USAGE GROUP
	DEFAULT	ATMEL AT91SAM9G45	TYPE	
1	GND		GND	
2	GND		GND	
3	NO CONNECT		NC	
4	NO CONNECT		NC	
5	SHDN	SHDN	OUTPUT	SYSTEM
6	NO CONNECT		NC	
7	GPIO0	PE0	I/O	GPIO
8	GPIO1	PE1	I/O	GPIO
9	GPIO2	PE2	I/O	GPIO
10	GPIO3	PE3	I/O	GPIO
11	GPIO4	PE4	I/O	GPIO
12	GPIO5	PE5	I/O	GPIO
13	GPIO6	PE6	I/O	GPIO
14	GPIO7	PE7	I/O	GPIO
15	GPIO8	PE8	I/O	GPIO
16	GPIO9	PE9	I/O	GPIO
17	GPIO10	PE10	I/O	GPIO
18	GPIO11	PE11	I/O	GPIO
19	GPIO12	PE12	I/O	GPIO
20	GPIO13	PE13	I/O	GPIO
21	GPIO14	PE14	I/O	GPIO
22	GPIO15	PE15	I/O	GPIO
23	NTRST	NTRST	I/O	JTAG
24	RTCK	RTCK	I/O	JTAG
25	TDI	TDI	I/O	JTAG
26	TDO	TDO	I/O	JTAG



EXPANSION CONNECTION (Continued)				
PIN	DEFAULT	ATMEL AT91SAM9G45	TYPE	USAGE GROUP
27	TMS	TMS	I/O	JTAG
28	NRST	NRST	I/O	JTAG,SYSTEM
29	TCK	TCK	I/O	JTAG
30	WAKE_UP	WKUP	INPUT	SYSTEM
31	DBG_RX	PB12/DRXD	I/O	DEBUG CONSOLE
32	DBG_TX	PB13/DTXD	I/O	DEBUG CONSOLE
33	SERIAL0_RX	PB5/RXD1	I/O	SERIAL PORT 0
34	SERIAL0_TX	PB4/TXD1	I/O	SERIAL PORT 0
35	SERIAL1_RX	PB7/RXD2	I/O	SERIAL PORT 1
36	SERIAL1_TX	PB6/TXD2	I/O	SERIAL PORT 1
37	TWI0_SDA	PA20/TWD0	I/O	TWI/I2C
38	TWI0_SCL	PA21/TWDCK0	I/O	TWI/I2C
39	SPI0_SPCK	PB2/SPI0_SPCK	I/O	SPI
40	SPI0_NPCS0	PB3/SPI0_NPCS0	I/O	SPI
41	SPI0_MISO	PB0/SPI0_MISO	I/O	SPI
42	SPI0_NPCS1	PD24/SPI0_NPCS1	I/O	SPI
43	SPI0_MOSI	PB1/SPI0_MOSI	I/O	SPI
44	SPI0_NPCS2	PD25/SPI0_NPCS2	I/O	SPI
45	PWR_SW*		I/O	SYSTEM
<i>* Connecting this pin to Ground enables the system to power up without a MicroSD card.</i>				
46	SPI0_NPCS3	PD27/SPI0_NPCS3	I/O	SPI
47	GND		GND	
48	GND		GND	
49	VDD_+5V		POWER OUTPUT	
50	VDD_+5V		POWER OUTPUT	
51	VDD_+3.3V		POWER OUTPUT	
52	VDD_+3.3V		POWER OUTPUT	
53	GND		GND	
54	GND		GND	
55	+5V_WALL_PWR		POWER INPUT	
56	+5V_WALL_PWR		POWER INPUT	



EXPANSION CONNECTION (Continued)				
PIN	DEFAULT	ATMEL AT91SAM9G45	TYPE	USAGE GROUP
57	VDD_+SYS		POWER OUTPUT	
58	VDDBU_+3V3		POWER OUTPUT	
59	GND		GND	
60	GND		GND	
61	VDDH_+20V		POWER OUTPUT	TEST/DEBUG
62	VEE_-20V		POWER OUTPUT	TEST/DEBUG
63	VPOS_+15V		POWER OUTPUT	TEST/DEBUG
64	VNEG_-15V		POWER OUTPUT	TEST/DEBUG
65	VDD_+1.8V		POWER OUTPUT	TEST/DEBUG
66	GVCC_-16.7V		POWER OUTPUT	TEST/DEBUG
67	VDD_+1.0V		POWER OUTPUT	TEST/DEBUG
68	VCOM_PANEL		POWER OUTPUT	TEST/DEBUG
69	GND		GND	
70	GND		GND	

LEDs

Four user controllable LEDs. Default uses are:

1. Orange - Power, system activity, heartbeat
2. Green - MicroSD disk access
3. Yellow - No default
4. Red - No default

Switches

1. Power
2. Switch 1
3. Switch 2

SD Card Slots

The Main Board has two card slots. Both slots fully support SDHC (Secure Digital High Capacity) version 2.0.

1. SD card slot
Used for expansion and user media.
2. MicroSD card slot
Used for system software and default firmware. It is also the main boot media.

Additional information about the system inputs and outputs including switches, LEDs, and others are found in the Linux kernel source code provided by CrystalFontz. See the [public repositories of CrystalFontz on GitHub](#).



OPTIONAL ACCESSORIES

TOUCHSCREEN

The resistive 4-wire touchscreen must be ordered at the time of the module. You may break the display if you try to add a touchscreen later or remove the installed touchscreen. Attempting to modify the touchscreen will void the warranty.

As is true for all touchscreens, the touchscreen slightly increases glare and slightly decreases clarity of the display.

EXPANSION BOARD FOR DEVELOPMENT AND DEBUGGING ([MISC-CFA10032](#))

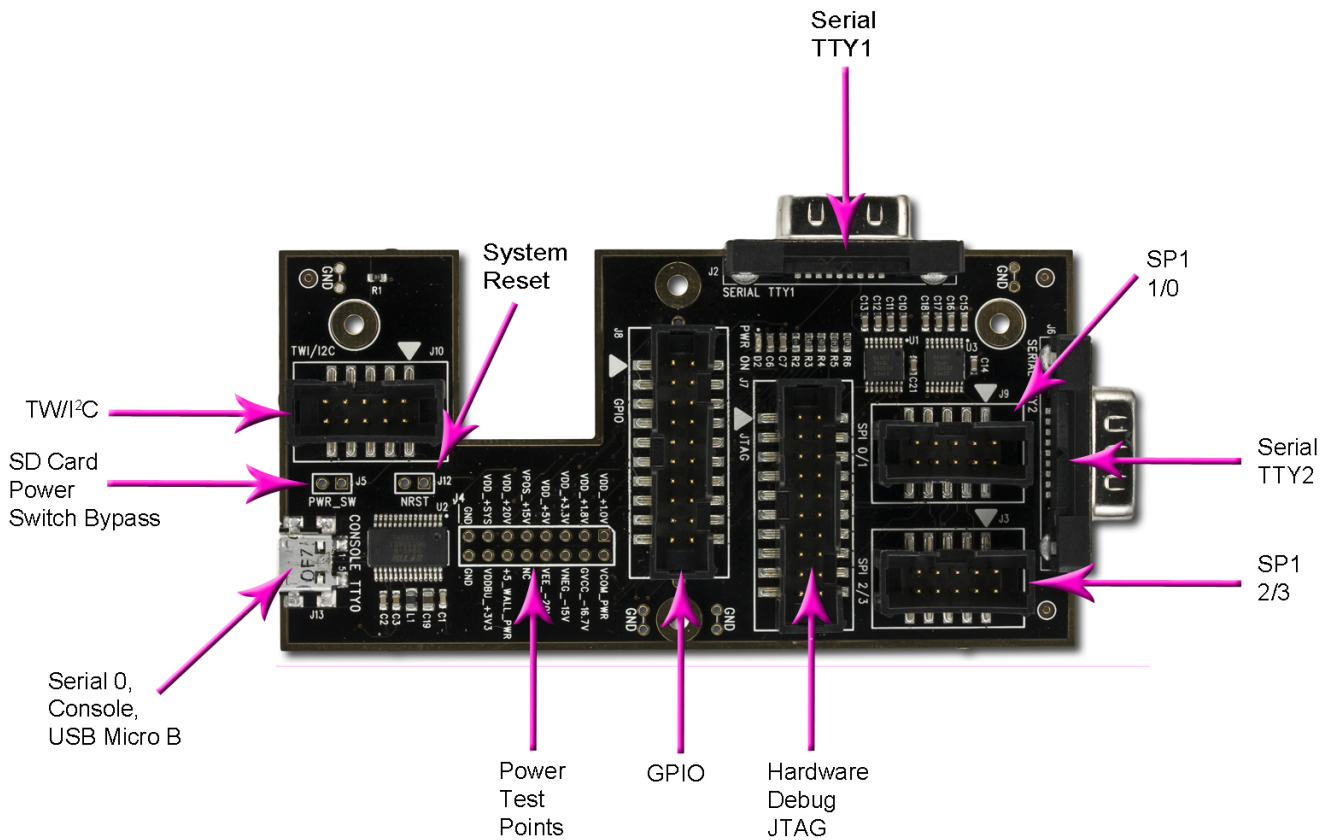

Figure 1. MISC-CFA10032 Expansion Board for Development and Debugging (Optional Accessory)

Connectivity Interfaces

The MISC-CFA10032 uses the expansion connector to bring out additional interfaces: debug console serial port, two RS232 serial ports, JTAG hardware debugging interface, GPIO pins, SPI port, and TWI/I²C master. The interfaces are described below.



Debug Console Serial Port (ttyS0 under Linux)

This is made available by a USB MicroB using an FTDI serial-to-USB chip.

DEBUG CONSOLE SERIAL PORT			
PIN	DEFAULT	ATMEL AT91SAM9G45	TYPE
1	VBUS		I/O
2	USB D-	*	I/O
3	USB D+	*	I/O
4	USB ID		NC
5	GND		GND

**The debug console uses FT232RLR to convert the TTL serial communication (DBG_TX, DBG_RX) to a USB virtual communication port (VCP).*



Two RS232 Serial Ports (ttyS1 and/or ttyS2 under Linux)

These are made available by the two DB9 connectors (SERIAL TTY1 and SERIAL TTY2).

PORT 0 RS232			
PIN	DEFAULT	ATMEL AT91SAM9G45	TYPE
1	NO CONNECT		NC
2	RS232_RX0	PB5/RXD1 (LEVEL CONVERTED)	I/O
3	RS232_TX0	PB4/TXD1 (LEVEL CONVERTED)	I/O
4	NO CONNECT		NC
5	GND		GND
6	NO CONNECT		NC
7	NO CONNECT		NC
8	NO CONNECT		NC
9	NO CONNECT		NC

PORT 1 RS232			
PIN	DEFAULT	ATMEL AT91SAM9G45	TYPE
1	NO CONNECT		NC
2	RS232_RX1	PB7/RXD2 (LEVEL CONVERTED)	I/O
3	RS232_TX1	PB6/TXD2 (LEVEL CONVERTED)	I/O
4	NO CONNECT		NC
5	GND		GND
6	NO CONNECT		NC
7	NO CONNECT		NC
8	NO CONNECT		NC
9	NO CONNECT		NC



JTAG Hardware Debugging Interface

J7, 2x10 male header, 0.1" centers

JTAG			
PIN	DEFAULT	ATMEL AT91SAM9G45	TYPE
1	VDD_+3.3V		POWER OUTPUT
2	VDD_+3.3V		POWER OUTPUT
3	NTRST	NTRST	I/O
4	GND		GND
5	TDI	TDI	I/O
6	GND		GND
7	TMS	TMS	I/O
8	GND		GND
9	TCK	TCK	I/O
10	GND		GND
11	RTCK	RTCK	I/O
12	GND		GND
13	TDO	TDO	I/O
14	GND		GND
15	NRST	NRST	I/O
16	GND		GND
17	NO CONNECT		NC
18	GND		GND
19	NO CONNECT		NC
20	GND		GND



16 GPIO Pins

J8, 2x10 male header, 0.1" centers

GPIO			
PIN	DEFAULT	ATMEL AT91SAM9G45	TYPE
1	GND		GND
2	VDD_+3.3V		POWER OUTPUT
3	GPIO0	PE0	I/O
4	GPIO1	PE1	I/O
5	GPIO2	PE2	I/O
6	GPIO3	PE3	I/O
7	GPIO4	PE4	I/O
8	GPIO5	PE5	I/O
9	GPIO6	PE6	I/O
10	GPIO7	PE7	I/O
11	GPIO8	PE8	I/O
12	GPIO9	PE9	I/O
13	GPIO10	PE10	I/O
14	GPIO11	PE11	I/O
15	GPIO12	PE12	I/O
16	GPIO13	PE13	I/O
17	GPIO14	PE14	I/O
18	GPIO15	PE15	I/O
19	GND		GND
20	VDD_+3.3V		POWER OUTPUT



One SPI Port

Four chip selects, J3 and J9 male header, 0.1" centers

SPI PORT WITH CHIP SELECT 0 AND CHIP SELECT 1			
$\overline{CS0}$ AND $\overline{CS1}$			
PIN	DEFAULT	ATMEL AT91SAM9G45	TYPE
1	GND		GND
2	VDD_+3.3V		POWER OUTPUT
3	SPI0_NPCS0	PB3/SPI0_NPCS0	I/O
4	SPI0_MOSI	PB1/SPI0_MOSI	I/O
5	GND		GND
6	SPI0_MISO	PB0/SPI0_MISO	I/O
7	SPI0_NPCS1	PD24/SPI0_NPCS1	I/O
8	SPI0_SPCK	PB2/SPI0_SPCK	I/O
9	GND		GND
10	VDD_+3.3V		POWER OUTPUT
SPI PORT WITH CHIP SELECT 2 AND CHIP SELECT 3			
$\overline{CS2}$ AND $\overline{CS3}$			
PIN	DEFAULT	ATMEL AT91SAM9G45	TYPE
1	GND		GND
2	VDD_+3.3V		POWER OUTPUT
3	SPI0_NPCS2	PD25/SPI0_NPCS2	I/O
4	SPI0_MOSI	PB1/SPI0_MOSI	I/O
5	GND		GND
6	SPI0_MISO	PB0/SPI0_MISO	I/O
7	SPI0_NPCS3	PD27/SPI0_NPCS3	I/O
8	SPI0_SPCK	PB2/SPI0_SPCK	I/O
9	GND		GND
10	VDD_+3.3V		POWER OUTPUT



TWI/I²C

TWI/I²C			
PIN	DEFAULT	ATMEL AT91SAM9G45	TYPE
1	GND		GND
2	VDD_+3.3V		POWER OUTPUT
3	GND		GND
4	TWI0_SCL	PA21/TWDCK0	I/O
5	GND		GND
6	NO CONNECT		NC
7	GND		GND
8	TWI0_SDA	PA20/TWD0	I/O
9	GND		GND
10	VDD_+3.3V		POWER OUTPUT



Various Voltage Test Points

If you need more information about the pins in the tables above, see the microprocessor datasheet at [Atmel AT91SAM9G45 ARM microprocessor](http://Atmel.AT91SAM9G45).

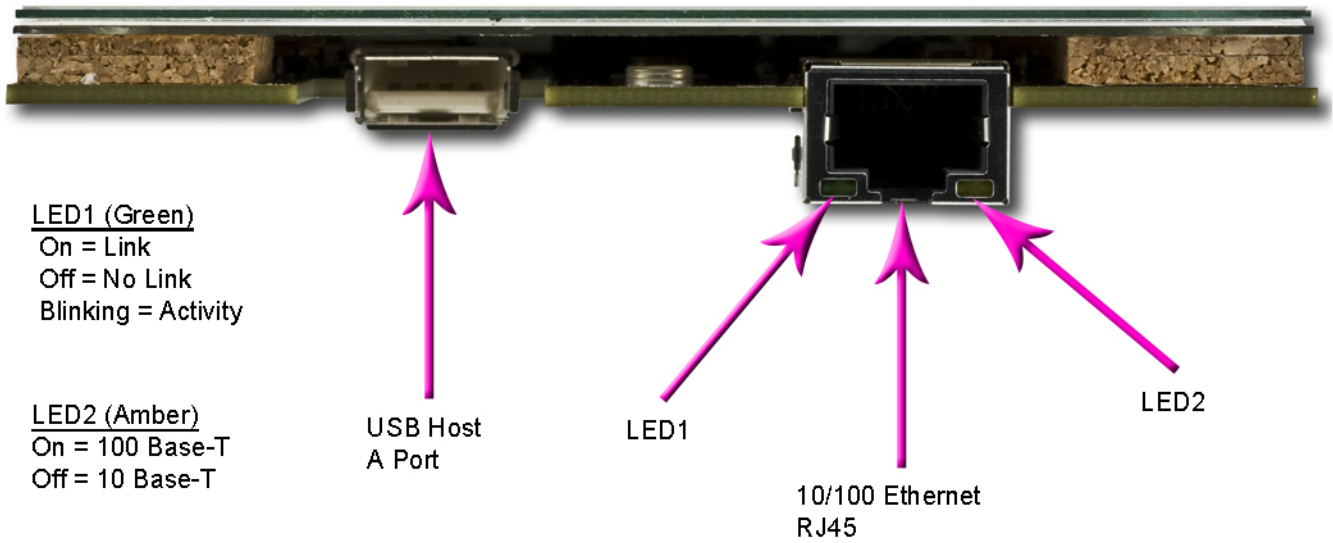

Figure 2. View of CFA910 Module Right Edge with Optional Touchscreen



MECHANICAL SPECIFICATIONS

PHYSICAL CHARACTERISTICS

Overall Dimensions

	Touchscreen	E Ink Display	CFA10022 Main Board	MISC-CFA10032 Development Expansion Board (includes connectors)	MISC-CFA10032 Development Expansion Board (excludes connectors)	Dimensions (millimeters)
	X					137.90 (W) x 104.10 (H) mm x 1.18 (D) maximum
	X	X				137.90 (W) x 105.10 (H) mm x 15.53 (D) maximum
X	X	X				137.90 (W) x 105.10 (H) mm x 16.53 (D) maximum
	X	X	X			144.00 (W) x 111.20 (H) mm x 22.68 (D) maximum
	X	X		X		137.90 (W) x 105.10 (H) mm x 21.64 (D) maximum
X	X	X	X			144.00 (W) x 111.20 (H) mm x 23.68 (D) maximum
X	X	X		X		137.90 (W) x 105.10 (H) mm x 22.64 (D) maximum



Additional Physical Characteristics

ITEM	SIZE
Viewing Area	124.00 (W) x 92.20 (H) mm
Active Area	122.40 (W) x 90.60 (H) mm
Pixel Pitch	0.153 (W) x 0.151 (H) mm
Overall Weight of CFA910 module (E Ink Display mounted on CFA10022 Main Board)	
Without touchscreen	108 grams (typical)
With optional touchscreen	137 grams (typical)
Overall Weight of CFA910 module (E Ink Display mounted on CFA10022 Main Board) with optional MISC-CFA10032 Development Expansion Board	
Without touchscreen	151 grams (typical)
With optional touchscreen	180 grams (typical)



ILLUSTRATIONS WITH DIMENSIONS (7 PAGES)

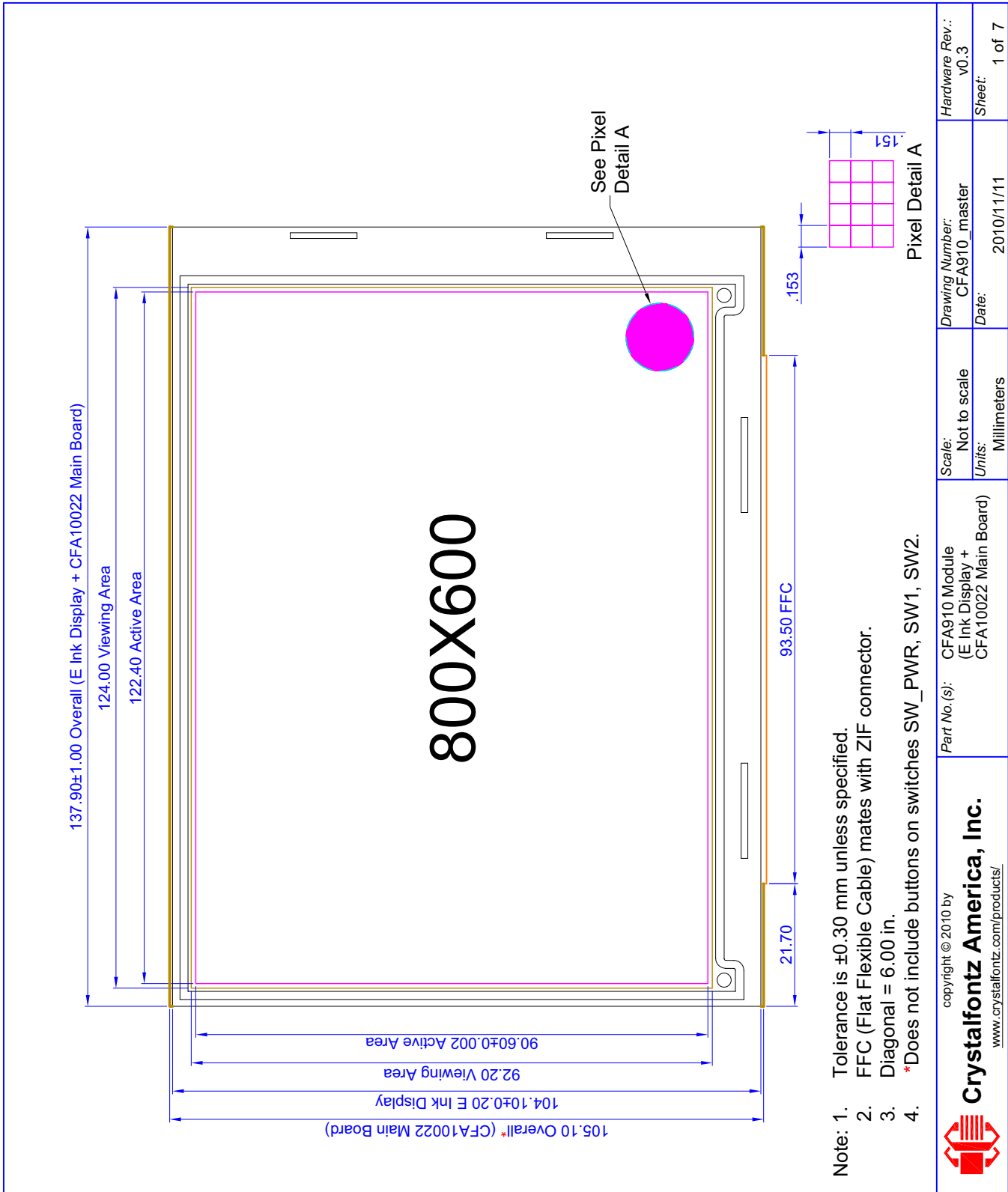

 copyright © 2010 by CrystalFontz America, Inc. www.crystalfontz.com/products/	Part No. (s): CFA910 Module (E Ink Display + CFA10022 Main Board)	Scale: Not to scale Units: Millimeters	Drawing Number: CFA910_master Date: 2010/11/11	Hardware Rev.: v0.3 Sheet: 1 of 7

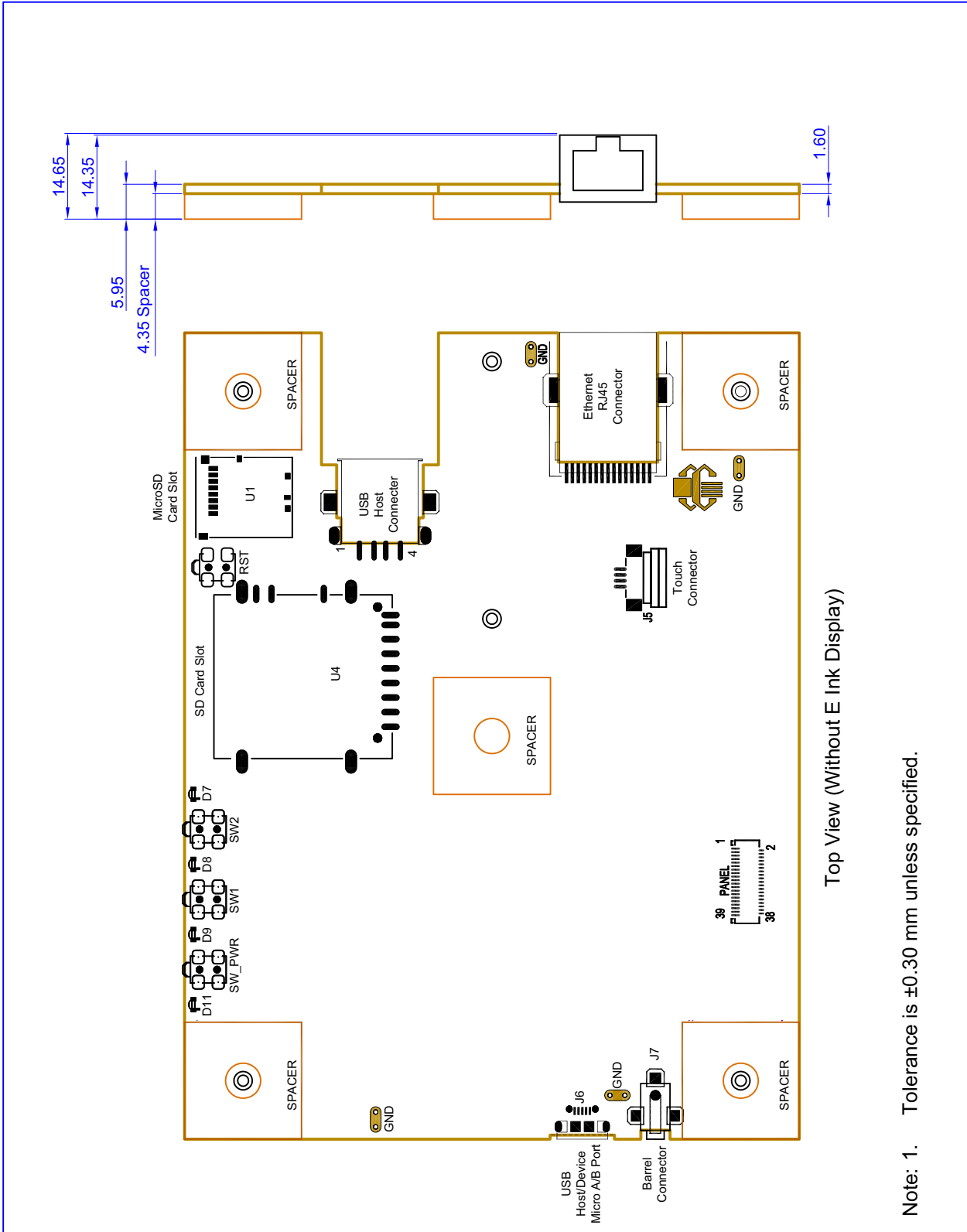

Top View (Without E Ink Display)

Note: 1. Tolerance is ± 0.30 mm unless specified.

<p>copyright © 2010 by CrystalFontz America, Inc. www.crystalfontz.com/products/</p>	<p>Part No.(s): CFA10022 Main Board for CFA910 Module</p>	<p>Scale: Not to scale Units: Millimeters</p>	<p>Drawing Number: CFA910_master Date: 2010/11/10</p>	<p>Hardware Rev.: v0.3 Sheet: 2 of 7</p>
---	--	--	---	---

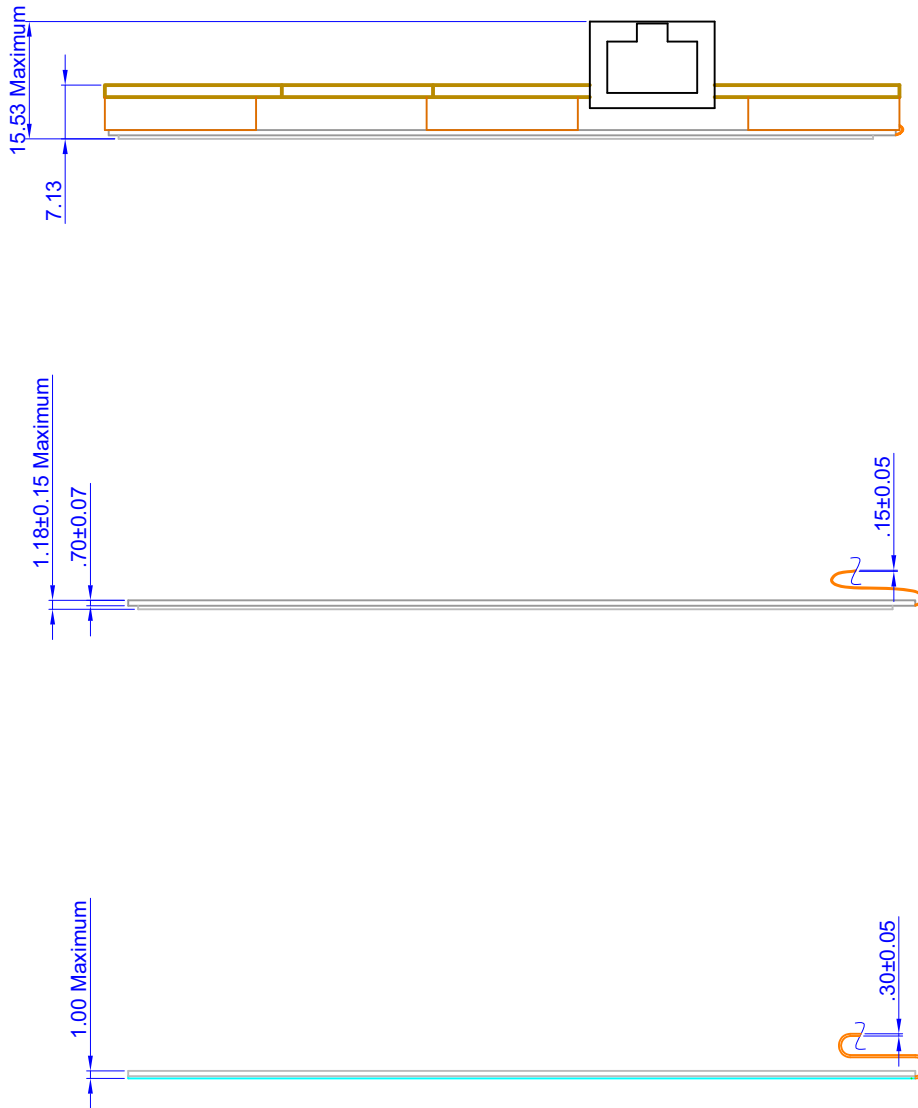

E Ink Display and
CFA10022 Main Board

E Ink Display

Optional Touchscreen

copyright © 2010 by CrystalFontz America, Inc. www.crystalfontz.com/products/	Part No. (s): Side Views of CFA910 Module Components Part A	Scale: Not to scale Units: Millimeters	Drawing Number: CFA910_master Date: 2010/11/11	Hardware Rev.: V0.3 Sheet: 4 of 7

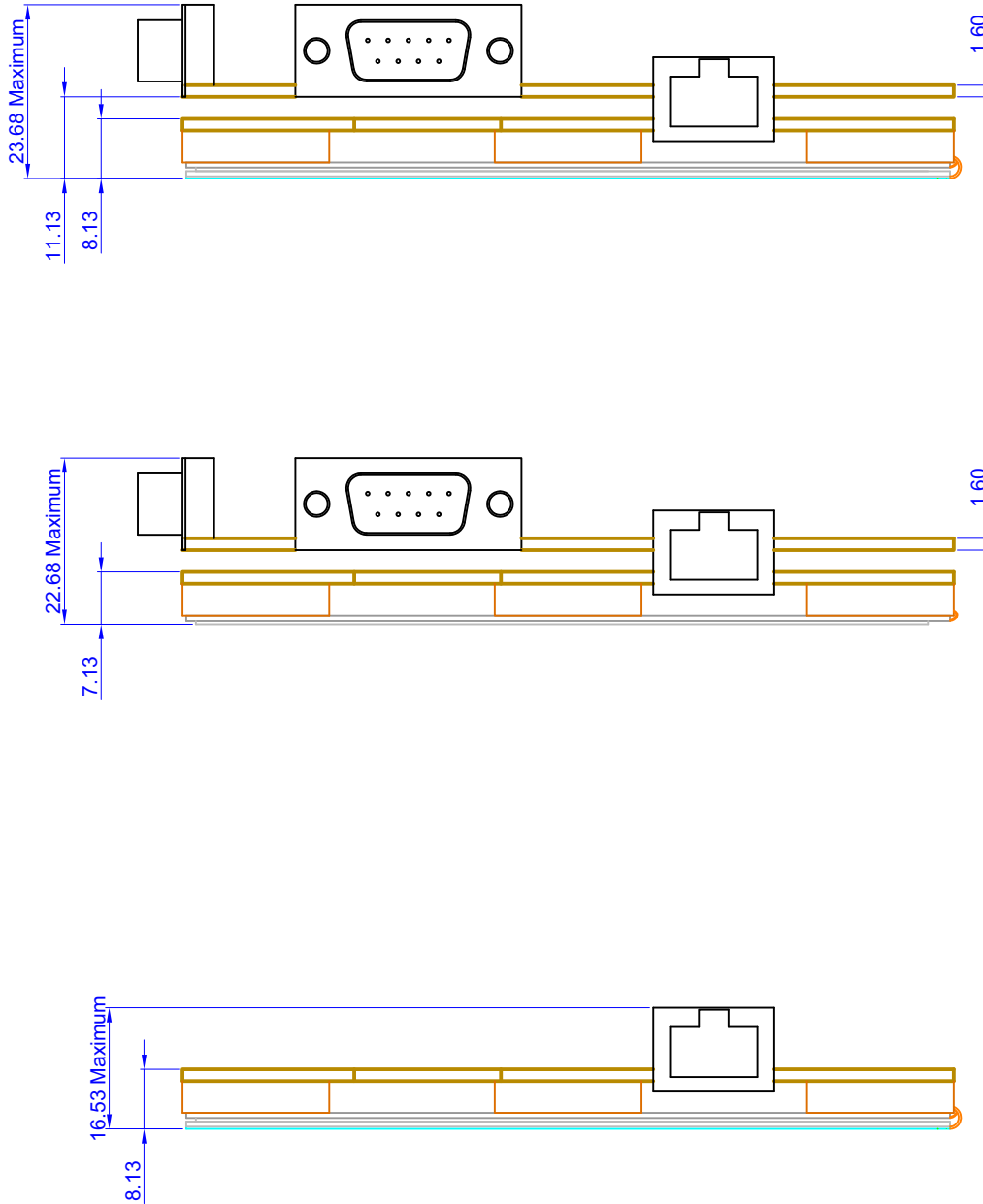

Optional Touchscreen,
 E Ink Display and
 CFA10022 Main Board

E Ink Display,
 CFA10022 Main Board, and
 MISC-CFA10032 Development
 Expansion Board

Optional Touchscreen, E Ink Display,
 CFA10022 Main Board, and
 MISC-CFA10032 Development
 Expansion Board

copyright © 2010 by

CrystalFontz America, Inc.
www.crystalfontz.com/products/



Part No.(s): Side Views of
 CFA910 Module
 Components
 Part B

Scale: Not to scale
 Units: Millimeters

Drawing Number:
 CFA910_master
 Date: 2010/11/11

Hardware Rev.:
 V0.3
 Sheet: 5 of 7

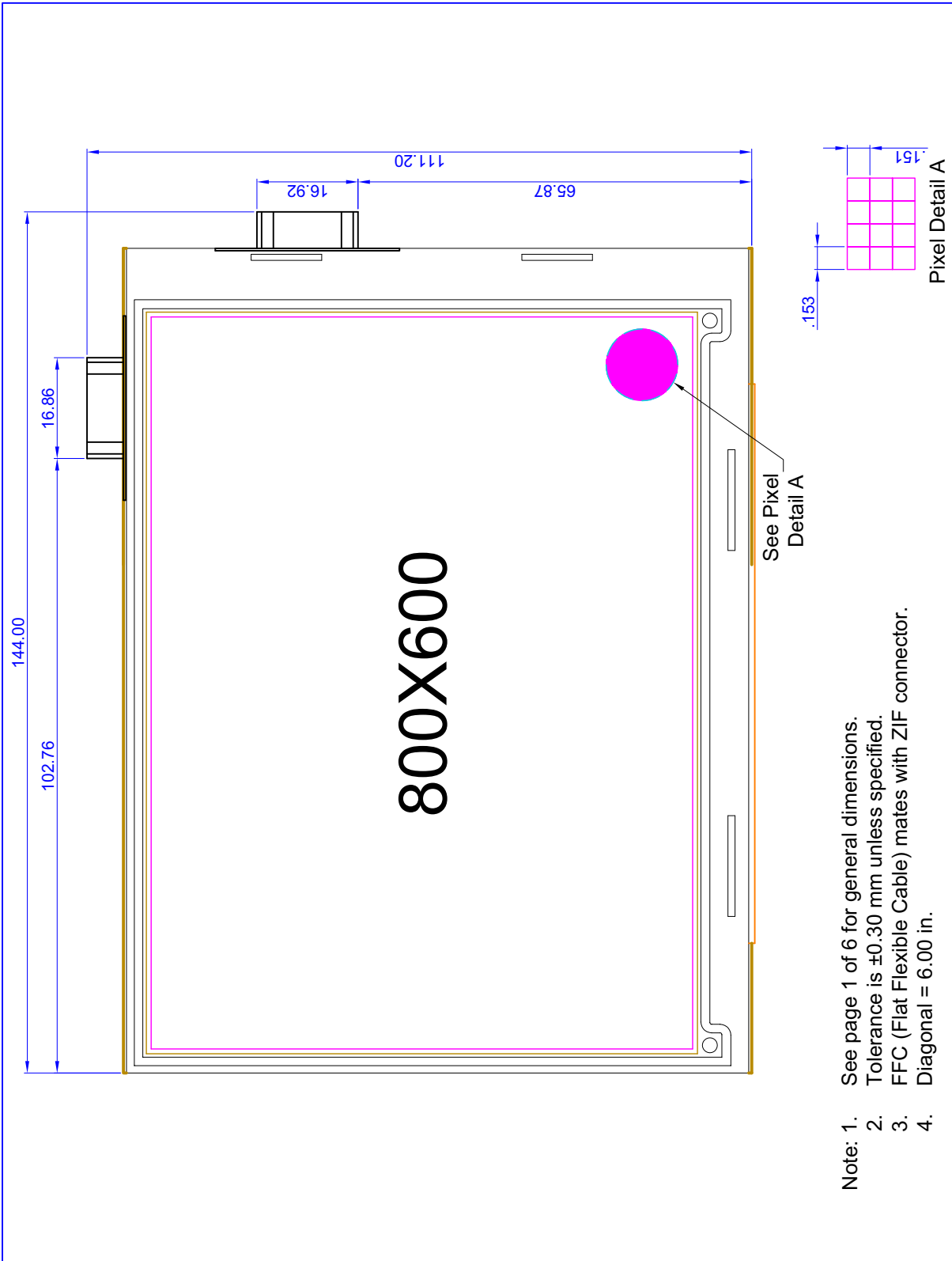

- Note:
1. See page 1 of 6 for general dimensions.
 2. Tolerance is ± 0.30 mm unless specified.
 3. FFC (Flat Flexible Cable) mates with ZIF connector.
 4. Diagonal = 6.00 in.

 CrystalFontz America, Inc. www.crystalfontz.com/products/	Part No.(s): CFA910 Module with MISC-CFA10032 Development Expansion Board	Scale: Not to scale Units: Millimeters	Drawing Number: CFA910_master Date: 2010/11/11	Hardware Rev.: v0.3 Sheet: 6 of 7
	copyright © 2010 by www.crystalfontz.com/products/			

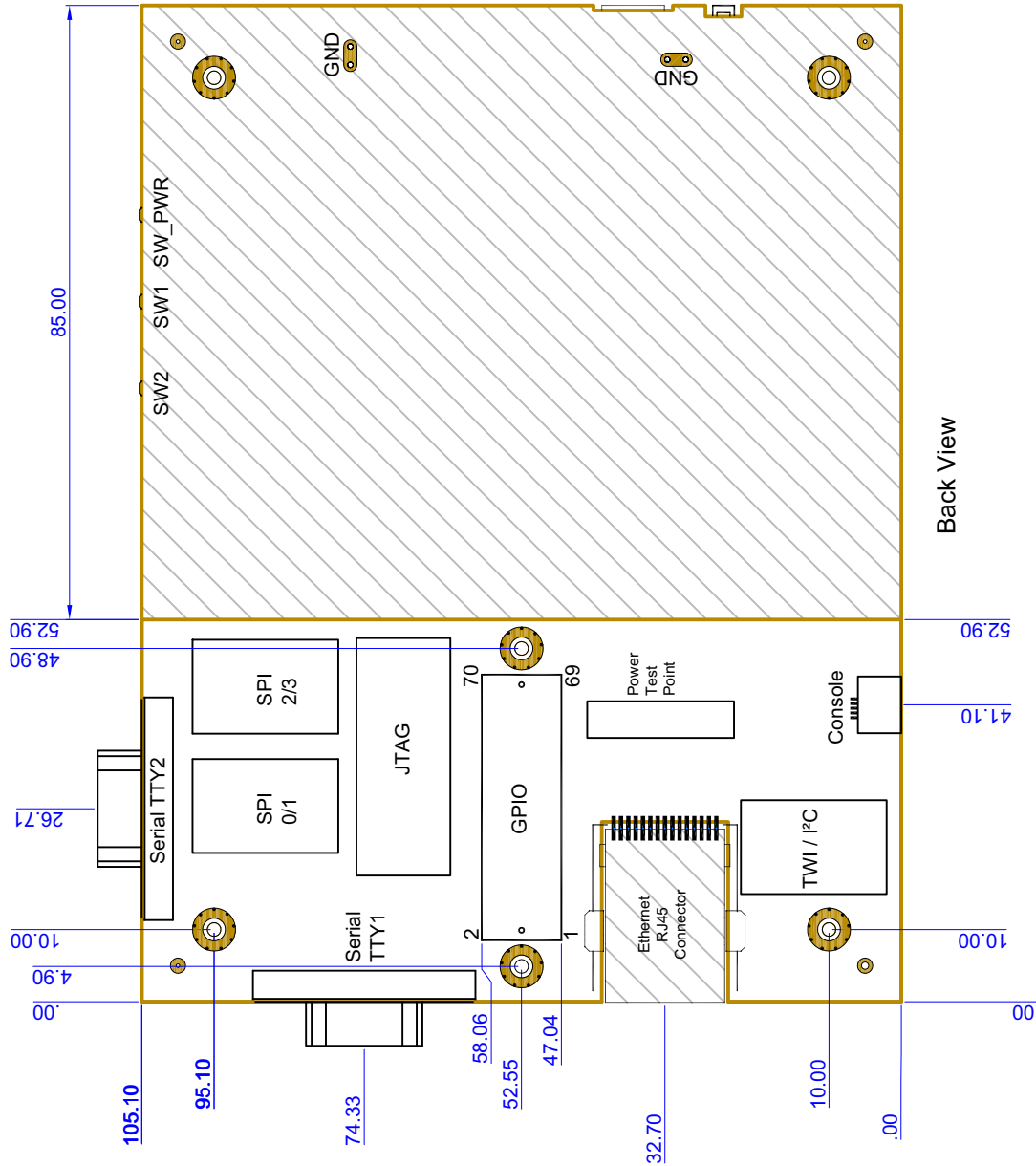

Back View

 CrystalFontz America, Inc. www.crystalfontz.com/products/ <small>copyright © 2010 by</small>	Part No. (s): MISC-CFA10032 Development Expansion Board	Scale: Not to scale Units: Millimeters Drawing Number: CFA910_master Date: 2010/11/11	Hardware Rev.: V0.3 Sheet: 7 of 7
--	--	--	--



CFA910 MODULE BLOCK DIAGRAM

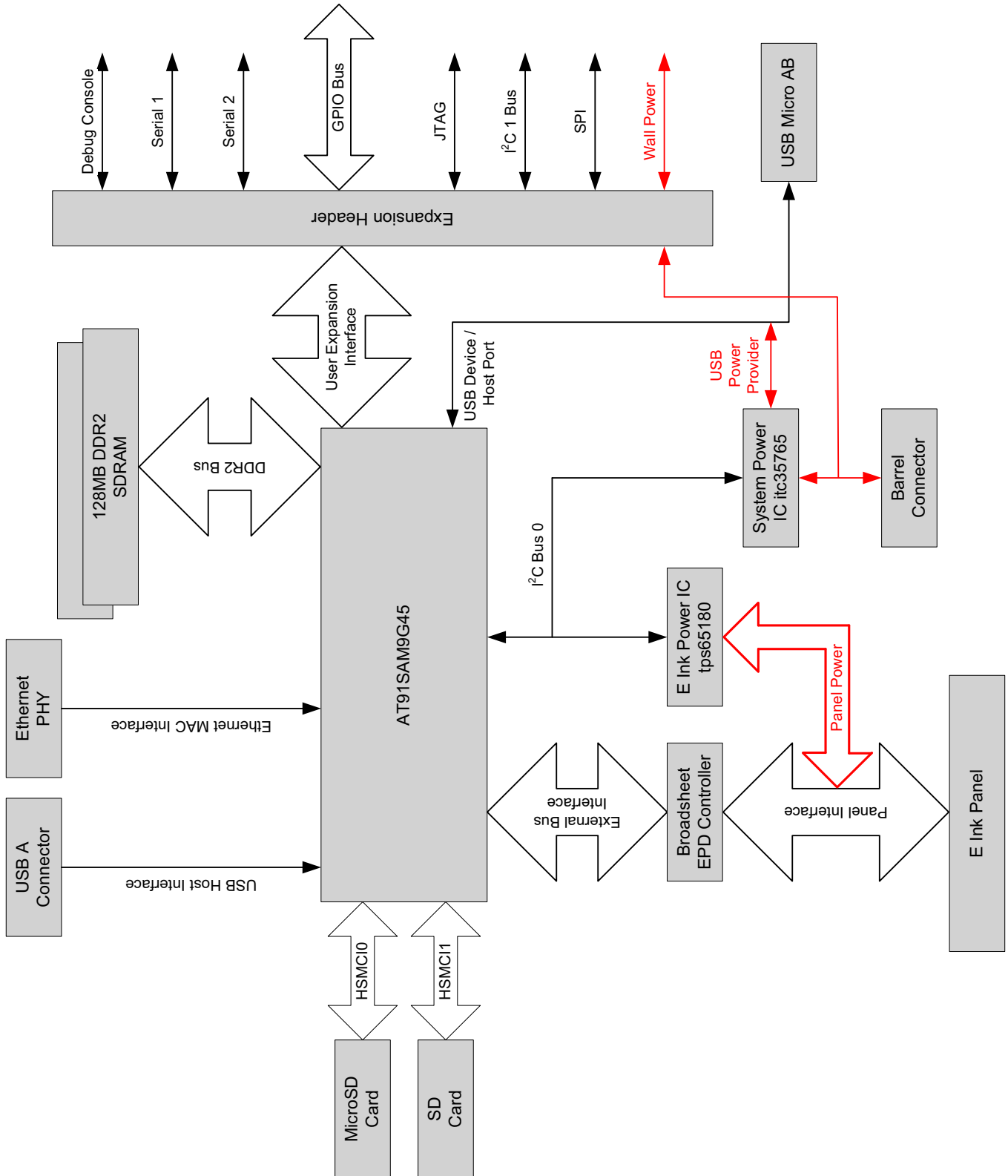

Figure 3. CFA910 Module Block Diagram



BUILD YOUR OWN APPLICATION

The CFA910 module is preprogrammed with Linux, X-Windows, and two demonstration applications. The demonstration applications are described in the boxed note [QUICK START DEMOS \(Pg. 5\)](#) on the first page of this Data Sheet.

The CFA910 module is composed of many open source software packages. Links to the software packages as well as Linux developer support is available through the CrystalFontz forum at <http://www.crystalfontz.com/forum/forumdisplay.php?f=36>. The forum is actively moderated by one of the developers.

CARE AND HANDLING PRECAUTIONS

For optimum operation of the CFA910 module and to prolong its life, please follow the precautions below. Excessive voltage will shorten the life of the module.

HANDLING

- Board edges are sharp -- be careful while handling.
- The Vizplex E Ink display's glass is intentionally thin. The display will withstand reasonable forces as would be expected from normal use (such as operating the touchscreen or pointing at the display). However, it is possible to push hard enough to break the display.
- The CFA910 module is sold with a Vizplex E Ink display mounted on the Main Board CrystalFontz CFA10022. Do not attempt to separate the Main Board from the Vizplex E Ink display: you will crack the display. If you attempt to modify the board to work with other displays, the warranty is void.
- The optional resistive 4-wire touchscreen must be ordered at the time of the CFA910 module. You will break the Vizplex E Ink display if you try to add a touchscreen later or remove an installed touchscreen. Attempting to modify the touchscreen will void the warranty.
- Use care to keep the exposed terminals clean. Contamination, including fingerprints, may affect the reliability of the connections.
- *Without touchscreen:* To protect the glass from damage, the Vizplex E Ink display ships with a protective film over the glass. Please peel off the protective film slowly. Peeling off the protective film abruptly may generate static electricity.
- *With touchscreen:* To protect the touchscreen from damage, the touchscreen on the Vizplex E Ink display ships with a protective film over it. Please peel off the protective film slowly. Peeling off the protective film abruptly may generate static electricity. The touchscreen is made out of plastic and can be scratched or damaged. Please handle carefully.

ESD (ELECTRO-STATIC DISCHARGE)

The circuitry is industry standard CMOS logic and susceptible to ESD damage. Please use industry standard antistatic precautions as you would for any other static sensitive devices such as expansion cards, motherboards, or integrated circuits. Ground your body, work surfaces, and equipment.

DESIGN AND MOUNTING

- The CFA10022 Main Board is easy to mount. It has prethreaded mounting PEMs installed on it that will take standard circuit board 256 standoffs.



- The optional MISC-CFA10032 Development Expansion Board is shipped mounted to the CFA10022 Main Board by a compression connector and two sets of four standoffs (8 standoffs total). The first four standoffs are installed between the Development Expansion Board and the Main Board. The second four standoffs are installed down through the top of the Expansion Board into the first four standoffs.
- *With touchscreen:* If you add a bezel to the CFA910 module, the bezel must be smooth where it touches the touchscreen. Your bezel should not apply undue force to the touchscreen. To avoid shorting, any mounting bezel should be at least 3 mm from the Active Area of the touchscreen.
- The CFA910 module can be mounted vertically onto a front panel using a variety of methods. If you have a plastic enclosure, it can be molded to have the CFA910 module snap into place. A metal enclosure can use a milled faceplate with mounting tabs to secure the module. Adhesives can be used, as long as they are not similar to "super glue" because these emit vapors that can damage the CFA910 module over time.

AVOID SHOCK, IMPACT, TORQUE, OR TENSION

- Do not expose the module to strong mechanical shock, impact, torque, or tension.
- Do not drop, toss, bend, or twist the module.
- Do not place weight or pressure on the CFA910 module. The Vizplex E Ink display's glass is intentionally thin. It is possible to push hard enough to break the display.

CLEANING

The Vizplex E Ink display's glass can be scratched or damaged. Be careful when you clean the glass. The optional touchscreen is plastic. The plastic can be scratched or damaged. Be careful when you clean the touchscreen.

- If the touchscreen or Vizplex E Ink display is dusty, you may blow it off with clean, dry, oil-free compressed air or gently wipe with a nonabrasive soft cloth.
- Use the removable protective film to remove smudges (for example, fingerprints) and any foreign matter from the glass or touchscreen. If you no longer have the protective film, use standard transparent office tape (for example, Scotch® brand "Crystal Clear Tape").
- *Liquid cleaner for glass:* Use a nonabrasive soft cloth moistened with a nonabrasive glass cleaner such as Windex®. Do not sprayer cleaner directly onto the glass -- overspray and drips can cause damage.
- *Liquid cleaner for optional touchscreen:* To clean the front of the touchscreen, gently wipe it with a nonabrasive soft dry cloth. If the touchscreen is still not clean, use a nonabrasive soft cloth moistened with isopropyl alcohol.

OPERATION

- Your circuit should be designed to protect the module from ESD and power supply transients.
- Observe the operating temperature limitations: from 0°C minimum to +50°C maximum with minimal fluctuations with humidity up to 90% RH, noncondensing. Rapid temperature changes can cause moisture to form, resulting in permanent damage. Operation outside of these limits may shorten the life and/or harm the CFA910 module.
- Operate away from dust, moisture, and direct sunlight.

STORAGE AND RECYCLING

- Store in an ESD-approved container away from dust, moisture, and direct sunlight, fluorescent lamps, or any ultraviolet ray.
- Observe the storage temperature limitations: from -25°C minimum to +70°C maximum with minimal fluctuations with humidity up to 80% RH, noncondensing. Rapid temperature changes can cause moisture to form, resulting in permanent damage.
- Do not allow weight to be placed on the CFA910 module while they are in storage.
- Please recycle your outdated Crystalfontz CFA910 module at an approved facility.



APPENDIX A: SCHEMATIC FOR MISC-CFA10032

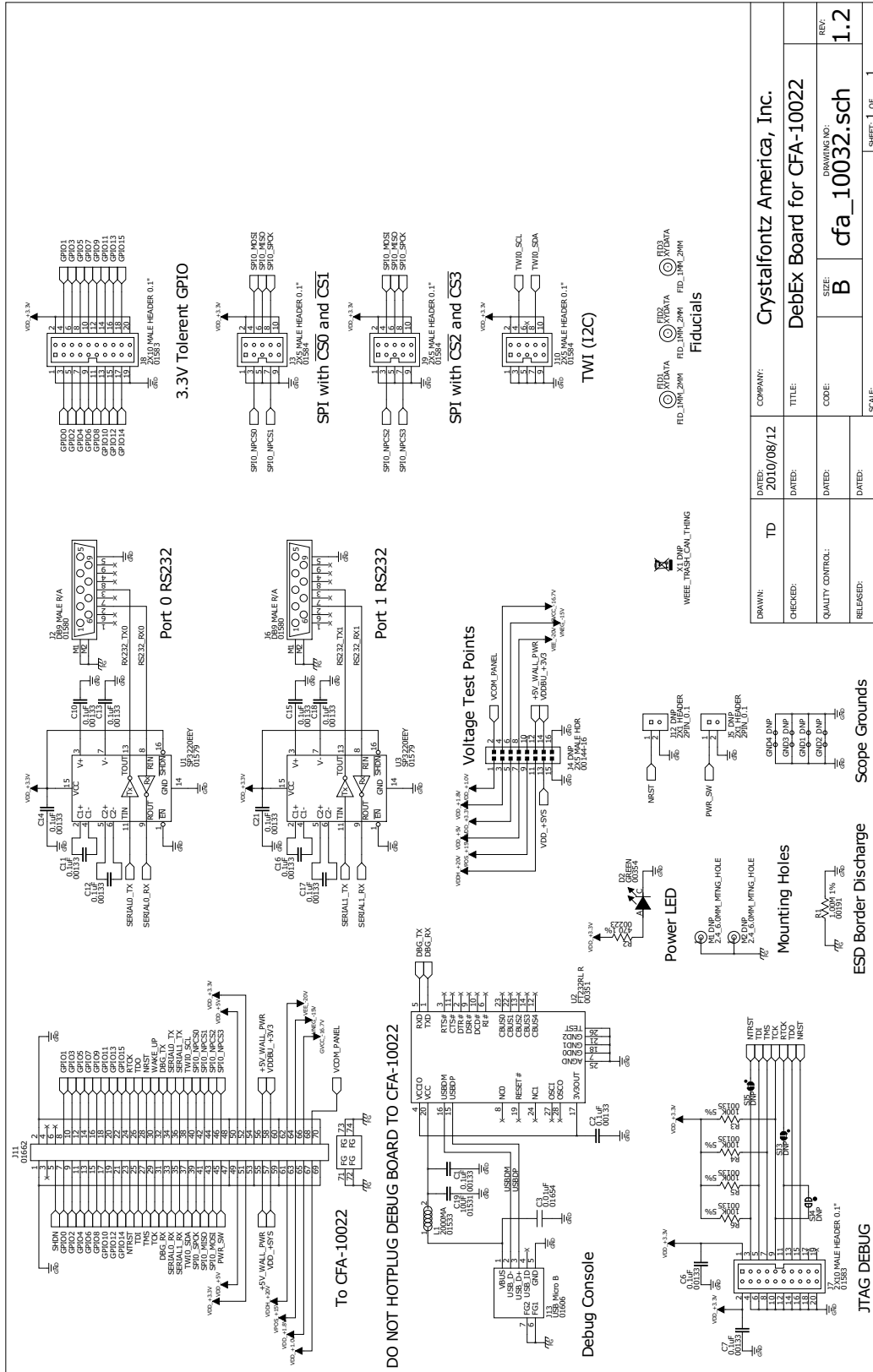

DRAWN:	TD	DATE:	2010/08/12	COMPANY:	Crystalfontz America, Inc.
CHECKED:		DATE:		TITLE:	DebEx Board for CFA-10022
QUALITY CONTROL:		DATE:		CODE:	B
RELEASED:		DATE:		SIZE:	cfa_10032.sch
				DRAWING NO.:	1.2
				REV.:	1.2
				SCALE:	1 OF 1

DO NOT HOTPLUG DEBUG BOARD TO CFA-10022