

UM-HSRI-BI-75-5

FINAL REPORT  
MAY 31, 1975

# PHYSICAL CHARACTERISTICS OF CHILDREN

## As Related to Death and Injury for Consumer Product Design and Use



HIGHWAY SAFETY RESEARCH INSTITUTE  
THE UNIVERSITY OF MICHIGAN  
ANN ARBOR, MICHIGAN 48105

Prepared for:

Consumer Product Safety Commission  
5401 West Bard Avenue  
Bethesda, Maryland 20014  
Contract No. FDA 72-70

Technical Report Documentation Page

1. Report No. UM-HSRI-BI-75-5		2. Government Accession No.		3. Recipient's Catalog No.	
4. Title and Subtitle Physical Characteristics of Children as Related to Death and Injury for Consumer Product Safety Design				5. Report Date May 31, 1975	
				6. Performing Organization Code	
7. Author(s) Snyder, R.G., Spencer, M.L., Owings, C.L., Schneider, L.W.				8. Performing Organization Report No. UM-HSRI-BI-75-5	
9. Performing Organization Name and Address Highway Safety Research Insitute Huron Parkway at Baxter Road Ann Arbor, Michigan 48105				10. Work Unit No. (TRAIS) 011167	
				11. Contract or Grant No. FDA 72-70	
12. Sponsoring Agency Name and Address Consumer Product Safety Commission 5401 West Bard Avenue Bethesda, Maryland 20014				13. Type of Report and Period Covered Final Report April 1972 to March 31, 1975	
				14. Sponsoring Agency Code CPSC	
15. Supplementary Notes					
16. Abstract A total of 41 body measurements were taken on 4027 infants and children representing the U.S. population from 2 weeks to 13 years old using specially modified anthropometers, calipers, and girth devices. These devices utilize a 10-turn potentiometer for electrical readout of length, and a miniature pressure transducer in the paddle blades of the anthropometers and calipers provides for standardizing measurements on soft tissue. Measurement data was recorded automatically by a portable NOVA 1220 mini-computer system. Center of gravity in standing and sitting position was also obtained. Other devices were utilized for obtaining finger diameters, hand clearance, and grip size dimensions. Data are presented in both tabular and graphical format giving the mean, S.D., 5th, 50th, and 95th percentiles and number of measurements (N) for each age interval.					
17. Key Words Anthropometry Consumer Products Center-of-Gravity Child Infant Automatic Data Acquisition				18. Distribution Statement  Unlimited	
19. Security Classif. (of this report) Unclass.		20. Security Classif. (of this page) Unclass.		21. No. of Pages 241	22. Price

UM-HSRI-BI-75-5  
Contract FDA-72-70

Final Report  
May 1975

PHYSICAL CHARACTERISTICS OF CHILDREN  
AS RELATED TO DEATH & INJURY  
FOR CONSUMER PRODUCT SAFETY DESIGN

Richard G. Snyder, Ph.D.  
Biomedical Department  
Highway Safety Research Institute  
and Department of Anthropology  
College of Literature, Science and the Arts

Martha L. Spencer, M.D.  
Department of Pediatrics and Communicable Diseases  
School of Medicine

Clyde L. Owings, M.D., Ph.D.  
Department of Pediatrics and Communicable Diseases  
School of Medicine  
and Department of Electrical and Computer Engineering  
College of Engineering

Lawrence W. Schneider, Ph.D.  
Biomedical Department  
Highway Safety Research Institute

## SUMMARY

This report presents the results of a three-year study designed to collect, analyze, and reduce selected anthropometric data on 4027 infants and children representative of the current U.S. population ranging in age from newborn to 12 years of age. Since the major purpose was to provide basic measurement data most useful and critical to consumer product design, regulatory consideration, or other direct applications, 12 of the 41 measurements taken were applied measurements which have not been previously available. As an example of the direct application to product design, measurement of buttock depth on 3-to 6-month-old infants provided an objective basis for establishment of crib interslat distances.

A substantial portion of the study involved the design, fabrication, development, and testing of a new generation of anthropometric measuring devices which transmit measurement signals to a portable mini-computer data acquisition system or to a set of readout meters. These include highly modified anthropometers and calipers for lineal measurements and a hand-held girth measuring device for circumference measurements. A pressure transducer has been incorporated in the moving paddle blade of the calipers and anthropometers in order to achieve greater reproducibility in making soft tissue measurements on infants and small children where immature skeletal development often precludes use of standard adult landmarks. Numerous specialized devices to measure inside and outside grip dimensions, finger diameters, and minimum hand-through-hole diameters have also been developed. In addition, two sizes of portable center-of-gravity (C.G.) devices designed during the study are capable of instantaneously measuring seated or standing centers of gravity. These instruments have been incorporated for use with a Nova 1220 mini computer to

provide a completely automated anthropometric measurement system for the majority of measurements taken.

The results presented in this report summarize the complete data which have been provided on magnetic tape for automated data analysis and retrieval. Each of the 41 measurements is defined and illustrated, and tabular charts are provided listing the mean, standard deviation, 5th, 50th, and 95th percentiles by age and sex, and for combined sexes. In addition, the mean, 5th and 95th percentiles are shown graphically.

TABLE OF CONTENTS

	<u>Page</u>
SUMMARY .....	i
TABLE OF CONTENTS .....	iii
LIST OF FIGURES .....	iv
ACKNOWLEDGEMENTS .....	v
I. INTRODUCTION.....	1
1. Background.....	1
2. Infant and Child Anthropometry Sources.....	5
3. Objectives and Scope.....	14
II. METHODS AND TECHNIQUE .....	15
1. Design of the Study .....	15
2. Procedure at Measurement Sites .....	27
3. Measurement Procedures .....	30
4. Inter- and Intra-Measurement Tests .....	31
5. Measurement Devices and Automated Equipment .....	32
6. Data Handling, Reduction, and Analysis.....	41
III. RESULTS .....	43
1. Description of Data Presentation.....	43
2. Interpreting the Tables and Graphs .....	44
3. Measurement Descriptions and Results .....	47
IV. RELATED TECHNICAL REPORTS AND PUBLICATIONS .....	229
V. REFERENCES CITED .....	231
APPENDIX PARTICIPATING SCHOOLS, DAY CARE CENTERS, NURSERIES AND CLINICS.....	239

## LIST OF FIGURES

<u>FIGURES</u>	<u>TITLE</u>	<u>PAGE</u>
Fig. 1.	An initial questionnaire form.....	20
Fig. 2.	Final questionnaire form.....	21
Fig. 3.	Questionnaire used for Spanish speaking people ....	22
Fig. 4.	Sample parental informed consent - English (a) Spanish (b) .....	23,24
Fig. 5.	Sample letter explaining project - English (a) Spanish (b) .....	25,26
Fig. 6.	Modified Dodge Maxi-Van used to carry equipment to the measurement sites .....	28
Fig. 7.	Drawings of modified anthropometer in (a) and mod- ified sliding caliper in (b).....	33
Fig. 8.	Photographs of modified anthropometer in (a) and modified sliding caliper in (b).....	34
Fig. 9.	Modified girth device .....	34
Fig. 10.	Nova 1220 portable mini-computer system .....	35
Fig. 11.	Keyboard and T.V. monitor showing initial display of MAP program.....	36
Fig. 12.	Member of measuring team carrying suitcase with measuring instruments and digital readout unit ....	37
Fig. 13.	Drawing of infant c.g. device indicating position of load cells and principal of operation .....	38
Fig. 14.	Infant c.g. device in (a) and child c.g. device in (b) showing subject in supine (standing) position..	39
Fig. 15.	Infant c.g. device in (a) and child c.g. device in (b) showing subject in the seated position with knee angle at 90 .....	40
Fig. 16.	Measuring team unloading computer from van at measuring site.....	41
Fig. 17.	Calcomp plot of waist measurement curves and data points.....	45

## ACKNOWLEDGEMENTS

This study has represented a major multi-disciplinary effort requiring the support and assistance of a large number of individuals over the three-year period of this work. The authors wish to gratefully acknowledge the valuable assistance provided by Gayle Kirma, Barbara Surovel, Emily Maiten, Barbara Johnson, Martha Kransdorf, Terri Gendel, Margaret Morris, and Susan Anderson in the tedious but critical task of taking measurements, coordinating schedules, and assisting in reducing the data; Barbara Nash, Peter Ford, and John Ferguson in writing the computer programs; Leigh Peck, and Paul Katz in technical assistance; and by Carol Ann Compton, secretary, who typed the manuscript and maintained the paperwork. Drs. John Gesink and Don Ellis gave freely of their expertise in the initial instrumentation design phase.

We are indebted to Dr. Anthony Schork, Pei Ruey, and Robert Anderson, Department of Biostatistics, School of Public Health, for biostatistical design assistance; to Dr. Stanley Garn, Center for Human Growth and Development; to Dr. Alphonse Burdi, Department of Anatomy, School of Medicine, the University of Michigan; and to anthropologists Dr. Herbert M. Reynolds, HSRI, Dr. John McConville, Webb Associates, Yellow Springs, Ohio, and Joseph W. Young, Chief Human Biology, Civil Aeromedical Institute, FAA, U.S. Department of Transportation, for their expert counsel in the design and technical operation of this study. Credit also should be given to Bert Lavastida, Douglas Rideout, and their staff at the Audio-Visual Education Center for their professional assistance in producing a documentary movie of this work.

We also wish to respectfully acknowledge the technical monitors who have managed this program during its development and whose foresight and experience has made a major contribution to the overall conduct of the work:



Carl W. Blechschmidt (April 1972 - Nov. 1973), John K. O'Connor (Nov. 1973 - April 1974) and Terry Van Houten (May 1974 - 1975), and more recently under the guidance of Dr. Albert Esch. Dr. Sam Southard, formerly of the National Commission on Product Safety, and Elaine Besson, were early supporters of this program.

The authors are grateful to the many school, day care center, nursery, and child care center administrators, teachers, physicians, and nurses who willingly gave their time and for their sincere interest and generous cooperation; and finally we wish to acknowledge the 4,027 infants and children (and their parents) throughout the country without whose willing participation this study could not have been conducted. It has been an experience which has been shared among many dedicated individuals.

## I INTRODUCTION

### 1. Background

The available estimates of infant and child fatality and injury data relative to consumer products have indicated the urgent need for improved design guidelines concerning body measurement data.

The total number of infants and children in the United States who died during 1974 consists of 74,667 infants under one year of age and 28,395 children from age one to fourteen years [1]. The majority of infant fatalities has been attributed primarily to endogenous factors for the first four post-natal weeks, and from four weeks increasingly to exogenous environmental influences. [2] By age one year accidents have been identified as the leading cause of childhood deaths [3-6]. During 1974, accidents accounted for 4,300 of the 11,548 reported deaths in the one- to four-year age group [1].

In testimony by the U.S. Department of Health, Education and Welfare at the National Commission on Product Safety Hearings of 21 October 1968, it was estimated that toys were responsible for injuries to 700,000 children each year [7]. Many of these injuries were concluded to be due to hazards imposed by non-existent or improper physical design standards. At present (1975) data from the Consumer Product Safety Commission indicate that upwards of 2 million children are injured each year in accidents attributed to toys, playground equipment, bicycles, and other children's products [8]. These figures are in agreement with those reported by the National Commission on Product Safety in 1970 [9, p.9]. Bicycle accidents alone in the U.S. have been estimated to be as high as 9,460,000 annually for children 5-18 years of

age. It is estimated that from 403,000 [10] to 760,000 [11] of the children involved require medical attention. The problem of bicycle related injuries has been reported on in a number of recent studies [12-19]. The Federal Hazardous Substances Act (as amended, January, 1971, Sec. 2 Par. (5), added by sec. 2 (d) of P.L. 91-113) specifies that "an article may be determined to represent a mechanical hazard if, in normal use or when subjected to reasonably foreseeable damage or abuse, its design or manufacture presents an unreasonable risk of personal injury or illness (1) from fracture, fragmentation, or disassembly of the article, (2) from propulsion of the article (or any part or accessory thereof), (3) from points or other protrusions, surfaces, edges, springs, or closures, (4) from moving parts, (5) from lack or insufficiency of controls to reduce or stop motion, (6) as a result of self-adhering characteristics of the article, (7) because the article (or any part or accessory thereof) may be aspirated or ingested, (8) because of instability, or (9) because of any other aspect of the article's design or manufacture" [20, p.6].

Only in recent years have pathological and clinical attempts been made to more closely define the exact cause of death in infants. These efforts have produced more objective statistics than have previously been available. As Neale has pointed out, in England in 1904 over 3,000 death certificates recorded "related to teething" as cause of death [4]. The need to improve such vague medical terminology has led to more careful assessments and testing techniques and more specific knowledge concerning cause of infant deaths and injuries may be reasonably made.

Although most tabulations use large generalized categories to tabulate cause of death, evidence is mounting that a large number of fatal and injurious "accidents" to infants and younger children involve the commercial products of

their environment at this age. In 1970 the National Safety Council recorded 1,520 deaths due to "mechanical suffocation" or "ingestion of food or object" in children under one year of age [21]; by 1974 this number was reported as 1,272 [1]. The death rate from accidental mechanical suffocation for children under one year of age involving beds and cradles was 18.6 (per 100,000 live births) in 1965, and was as high as 27 in 1959. Keddy, in a study of injuries in 17,141 Canadian children, found 589 cases of falls from furniture, 271 injuries due to screws, nails, or tacks, 97 due to splinters, 261 falls on or against furniture, 250 injuries in contact with furniture, and 130 from falls from beds [22]. Although these generalized data are not conclusive, they do suggest that a strong relationship exists between improperly designed furniture and accidental death and injury.

Few studies of this specific relationship have appeared in the clinical literature. However, communications with individual pediatricians and coroners support the fact that many cases of death or injury have been attributed to improper or dangerous design of infant or juvenile furniture. In Florida, Blackbourne noted 13 cases of crib strangulation of infants. In testimony before the National Commission on Product Safety he estimated that 100 to 200 deaths might occur annually due to neck impingement in cribs. This opinion was confirmed by Kravitz in Chicago; and in 55 cases in Orange County, California, five were attributed to faulty design in infant furniture [23].

Six case histories in Rochester, New York, over a two-year period of accidental crib and high chair strangulations were reported by Greendyke [24], who concluded that "Crib sides should be constructed in such a way as to preclude the remotest possibility of a baby's head passing between them." Observations concerning the potential hazards of restraining devices in cribs and high chairs

were in agreement with previous studies by L'Hirondel [25,26] and by Zachow-Christiansen and Jensen [27]. Haddon has indicated the need of obtaining further data on crib injuries from an epidemiological point of view [28]. A 1970 staff report of the National Commission on Product Safety found that cribs accounted for an estimated 144 deaths [29]. Of these deaths, the mechanism of fatality was attributed to suffocation in 75% of the cases.

In regard to this problem an anthropometric study was conducted by the authors in conjunction with the larger anthropometric survey reported upon herein for the Consumer Product Safety Commission. This report was submitted to the Commission in January, 1973 [30]. These data were utilized by the commission to determine the subject dimension limitations between crib slats that will not permit infants to slide through [31].

Other functional safety-oriented dimensions are still urgently needed in this regard, particularly with respect to body segments. Recently, for example, inquiries have been made to the Department of Transportation regarding the use of their infant anthropomorphic test device in evaluating the stability characteristics of high chairs, strollers, and other infant and child seating and resting devices. However, specifications for a representative anthropomorphic test device which has shape and biomechanical properties based on infant sample data are still unavailable.

To date, only limited information as related to the U.S. population has been available to the manufacturer and to those concerned with Federal Standards for the safe design of toys, equipment, furniture or other products used by children. Numerous illustrations of needed measurement data have been identified by the National Commission on Product Safety's analysis of common products associated with injuries and fatalities [9].

## 2. Infant and Child Anthropometry Sources

The major purpose of this study has been to provide basic selected measurement data on infants and children, particularly functional measurements essential for the development of adequate product safety design standards. A comprehensive review of the literature was undertaken during the initial phase of this program. Some 800 studies are referenced in the publication Source Data of Infant and Child Measurements: Interim Data 1972 [32]. Since anthropometric studies may be either cross-sectional (taken on different subjects of a population at about the same time) or longitudinal (taken on the same group of subjects periodically over a long period of time), data were tabulated by American or foreign populations and by author in sections relating to cross-sectional or longitudinal. In addition, existing data from 35 studies conducted from 1929 through 1972 were tabulated for 23 selected measurements most frequently found in the literature.

Despite the profuse literature, this extensive review of the existing data indicated a number of serious limitations in usage of available data and documented the complete lack of many needed functional measures, concurring with previous surveys of child measurement data. Only one-third of the selected 35 studies provided data from the preceding 10 years. Many growth studies (as recently as Marshall and Carter, 1975) [33] have found that children have been getting taller (larger) than their parents through several generations, and that there are regional differences. Early studies taken in one geographic location, therefore, such as white Philadelphia school children, white Alabama school girls, or Iowa children may not be representative of the current U.S. population. Regional variations as well as socio-economic, nutritional, and ethnic or racial variations have been

found. There is considerable literature on infant or child height (stature or crown-rump; crown-heel) and weight, particularly in clinical references. But even for these measurements, data have often been taken by several different measurers in the same study, and often there was found to be questionable accuracy. In many longitudinal studies new subjects were added in the middle of a study as old subjects were lost. Many studies are not directly comparable, not only because of differences in precisely defining measurements (or lack of any definition), but because of age differences. While age 5 in one study may mean exactly 5 years post-birth, another study may include subjects from 4 1/2 to 5 1/2 years; or, in another, age 5 may mean from age 5 to 6 years. Such discrepancies provide a number of problems to the user of anthropometric data on children, particularly if the validity and applicability of each source is not carefully examined.

This comprehensive review of the child and infant anthropometry data available to date shows that while large numbers of limited studies have been conducted, including routine clinical measurements of a few measures such as body weight, stature, and chest or head circumference, the type of dimensional data urgently needed for a number of current safety applications is non-existent. Until the present study, no body of data has been published which validly describes such functional measures as the range of size openings an infant or child's hand or fist can penetrate for various "age" levels, the distance the arm or leg can extend, or the size opening the buttocks can slide through. A meticulously conducted survey to obtain 18 facial measurements for oxygen mask design on 978 infants and children from 1 month through 17 years was completed by Young in 1966 [34]. Although the sampling was composed entirely of subjects in Oklahoma County, Oklahoma, this remains the most useful data relative to facial anthropometry on children. In 1971, Stoudt,

in a study conducted for the National Highway Traffic Safety Administration, reviewed "anthropometric inputs to describe children for purposes of crash kinematic modeling and construction of anthropometric dummies for use in crash tests" [35]. He concluded that "existing data were found to be far from adequate for either of these two purposes" [35 p.53] In 1975 Young, McConville, Reynolds, and Snyder provided the most recent review and analysis of anthropometric requirements for NHTSA three- and six-year-old child anthropometric test devices, finding that some 60% of the anthropometric measurements necessary were not available in the literature, and many of the remainder were represented by questionable, inadequate, or outdated data [36].

Aside from the relatively few attempts, such as the studies cited, to obtain functional measurements, most of the literature pertains to more classical types of measurements. Studies prior to 1938 have been comprehensively covered by Krogman, who summarized in some 967 pages the results of child growth data to that time [37]. Some 40 years have now elapsed since even the most recent of these measurements were collected, and there could be question as to how representative such data are relative to the current U.S. population.

There is also the difficulty of attempting to determine specifically how a measurement was defined by the author and how it may differ from those of comparable studies with the same measurement names. A classic example of this is the use of the term "hip breadth" in the literature, which could, in fact, be two very different skeletal measurements, the bi-iliac or bitrochanteric diameter, or in other cases the maximum breadth across the soft tissue. Even if it refers specifically to the "bitrochanteric" measurement, there may be a difference in technique between authors as to how they measure from this landmark. In the instance of an obese individual it may be extremely



difficult to locate (palpate) the landmark, and in the case of an infant or child the bony landmark may not yet be fully formed. Further, "hip breadth" can be taken in a standing or seated position (it is larger when seated), or clothed or unclothed. Often these factors of different techniques make studies non-comparable, and this is a primary reason why the major two-volume reference source in the field of anthropometry, A Collation of Anthropometry, was compiled by Garrett and Kennedy in 1971 [38]. This lists over 2000 dimensions from 48 U.S. and 16 foreign studies, but does not include data from infant or adult surveys.

Several of the major American cross-sectional anthropometric studies would include Collins and Clark's 1929 study of chest, sitting height, stature, and weight for 6-14 year olds [39]; Gray and Ayres' 1931 study of 15 dimensions of 4,583 1-14-year-old children [40]; Wise and Meredith's 1942 study of 15 measurements on 112 2- to 5-year-old white Alabama girls [41]; Meredith's 1953 study of 11 measurements on 7- and 10-year-old boys and 7-, 9-, and 11-year-old girls [42]; Eppright and Sidwall's 1954 study of 5 measurements of 6- to 14-year-old Iowa Children [43]; Meredith and Knott's 1962 study of 8 measurements on 390 9-, 11-, and 13-year-old girls [44]. More recently, data has been published on 10 measurements for children to age 14, [45] obtained in the ten-state nutritional survey.

Stature and weight have been most commonly taken, and many studies have been confined solely to these two dimensions. One of the most recent examples is the 1967 study of height and weight by Rauh et al. on 8,480 Cincinnati school children aged 5 through 16 years [46].

Although numerous studies, particularly in the clinical literature, have noted weight, height, and head and chest circumference in new-borns,

more complete data have seldom been obtained or published. Only two studies of applicable infant anthropometry on a U.S. population were previously available in the literature, and each of these have distinct limitations. In 1934, Bakwin and Bakwin reported measurements of 24 dimensions on 1,653 newborns and 9 additional dimensions on 281 infants [47]. These were taken by classical techniques described in 1931 [48]. These data are not representative of the new-born infant of 1975, some 40 years later, due to a generational increase in both height and weight at various age levels. A subsequent study of body dimensions at birth, 3, 6, and 12 months was reported in 1957 by Kasius et al. for 1,391 infants whose mothers attended the Nutrition Clinic of the Pennsylvania Hospital between 1947 and 1952 [49]. Limitations of this study include the fact that only eight body dimensions were included, the sample was probably not representative of a general U.S. population for these ages, and these limited data are now nearly 30 years old. Burdi et al. recently brought together general growth and morphological data; but they could not find sufficient applicable measurement information [50], due to the almost complete lack of basic information regarding the anatomical differences between the child and the adult generally available to the engineer in safety design.

Several early studies have attempted to obtain functional child measurements, primarily for seating and school furniture, or for clothing requirements. Bennett measured 3,615 school children (kindergarten through grade 12) in 1928, using an adjustable chair and desk, but published only erect seated body measurements [51]. O'Brien reported on 35 standard measurements taken on 147,088 children, aged 4 to 17 years between 1937 and 1939, for sizing garments [52,53]. However, measurements were taken by 266 individuals, and the potential for inter-measurer error was very large.

In 1938, Stayton measured 100 ninth- to twelfth-grade girls, from 14 to 21 years of age, in Sebastopol, California, for sewing table activities [54]. Anderson, in 1941, measured 87 ninth grade girls from 13-17 years of age, and 100 twelfth-grade girls 16 to 22 years of age, in Corvallis, Oregon, primarily relative to kitchen activities [55]. Martin published data in 1953 [56] and 1954 [57] for use by school furniture manufacturers, but provided only average measurements for children between 4 and 17 years. The data were not obtained directly by measurement, but instead were derived from 11 previous studies conducted between 1922 and 1942. In 1955 this work was updated, using an adjustable chair, on children 5 to 14 years [58]. However, caution must be used with these data, since all measurements, including stature and weight, "were taken with the subject dressed in the indoor clothing, and wearing the type of shoes ordinarily worn in school"[58, p.100].

One of the most authoritative and useful general sources of applied human requirements is found in the compendium by Damon et al. 1966 (revised 1974) [59]. This work has brought together results from a large number of studies, including the anthropometric portion of the U.S. National Health Examination Survey, and includes sections summarizing the state of knowledge of anthropometry and human engineering, biomechanics and equipment design, human body composition and tolerance to physical and mechanical force, and design recommendations. However, despite an enormous and extremely useful compilation of anthropometric data, the only measurements listed for infants and children consist of one table of mean heights and weights of white Americans from birth through one year at one-month intervals, from one year to 5 1/2 years at 6 month intervals, and annually from 6 to 19 years [60]. No other information, except for these two dimensions representing a selected population, is listed for either infants or children under age 16. This reflects the fact that reliable design data for this population have not been available.

In 1964, a comprehensive search with the objective of bringing together all available child data was initiated for the Division of Accident Prevention of the U.S. Department of Health, Education, and Welfare "...to meet the urgent need for child measurements to be used in testing dummies." The resulting literature survey by McConville and Churchill [61], Source Data for the Design of Simulated Children's Body Forms, attempted to collect design data that would describe the circumference, breadth, and depth of the body at specific levels, the length of body segments, and the location of primary hinge points for the infant at birth and 6 months, and the unisex child at 3, 6, 8, and 12 years, and males and females at age 18. Of 87 proposed anthropometric dimensions, 22 were completely unavailable in the literature. Only 25 dimensions were found for the 6 month olds, 29 for three year olds, and 39 for 6-year-old children. It was observed that "This lack of detailed anthropometric information is somewhat suprising in view of the number of such studies which have been carried out in the past few decades." Few studies provided all of the desired statistics, and it was necessary to take "...certain liberties..." in the treatment of those available [61, p.7]. Infant data were found to be extremely limited.

Many excellent longitudinal growth studies have been conducted. However, these have generally been reported for a limited geographic area or socio-economic group. Examples of these are the longitudinal studies of Philadelphia children by Krogman 1959 [62]; 1970 [63], and Krogman and Johnston, 1965 [64]. Vickers and Stuart measured Boston school children for 10 body measurements reported in 1943, having made periodic measurements on the same individuals from childhood to adulthood [65]. A comprehensive compilation of such studies through 1972 can be found in Snyder, et al., 1972 [32].

Longitudinal studies, while very useful for child growth investigations, generally do not provide the type of measurements necessary for functional applications. In addition, there usually is a lack of uniformity in how the measurements were taken. This precludes meaningful comparisons of particular dimensions reported in various studies. And since longitudinal projects usually involve a specific geographic location and particular socio-economic, ethnic, and racial populations, such data are difficult to pool as descriptive of the U.S. population. Where data are taken from longitudinal studies, N values are commonly not the same across time, due to attrition of subjects and loss of follow-up data. In long-term studies, new subjects are often added in the middle of the study. Such considerations, often not known or obvious to the user, make it difficult to evaluate and compare data in the literature.

The location of the center of gravity of infants or children has rarely been identified. In a 1927 to 1929 study not reported until 1944, Palmer measured 1,172 subjects ranging in age from birth to 20 years, including 18 fetal cadavers [66]. Of those subjects, 673 were infants and children, newborn through age 12, located in St. Paul and Minneapolis, Minnesota, and Mooseheart, Illinois. More recently (1965) Swearingen and Young [67] using a mechanical balancing apparatus for children, determined the seated and standing C.G. on 1200 Oklahoma school children aged 5 to 18 years (with shoes and clothes on). Swearingen et al. in 1969 obtained the center of gravity of 135 "crying, wiggling" clothed infants to 36 months of age using a simple scale balancing device [68].

In 1956 the National Center for Health Statistics was authorized to conduct a nationwide Health Examination Survey (HES). The first cycle,

conducted between 1959 and 1962, measured adult individuals age 18 to 79 years. The second program was aimed at growth and development aspects of 6- to 11-year-old children. It continued from July 1963 to December 1965, with 21 body measurements reported in 1973 [69]. Two previous reports analyzed eight and weight measures by age, sex, race and various socio-economic indicators (1972) [70, 71]. A fourth report (1972) presented data on skinfold thickness [72], and the most recent report (1974) compared the growth patterns of White and Negro children for 20 body measurements [73]. A third cycle which began in March 1966 and was concluded in 1970 was concerned with youths aged 12-17 years. As part of this health survey for 12- to 17-year-youths, body measurements were included; but, unlike the body measurements selected in cycles I and II, these excluded human engineering type measures ("...it was decided for cycle III that accurate biological data on growth and development in U.S. Children had a higher priority than human-engineering data, so the battery of body measurements is basically the traditional anthropometry used in the longitudinal studies of growth and development conducted in this country over the past 40 years") [74, pp. 5-6]. Since physical measurements were not the primary purpose of the HES study, some severe limitations were placed on those that could be taken, due to a time restriction of about 10 minutes per subject. Nevertheless, some 38 measurements were obtained, although as of this date (over 4 years later) only weight and stature (1973) [75], sitting height (1973) [76], and skinfold thickness (1974) [77] data have been published. Examination of those measurements indicates that there remains a need for functional anthropometric measurements for use in design above the traditional growth measures taken in the HES study.

### 3. Objective and Scope

The objectives of the project was to: (1) determine and define measurements to be taken, (2) design, develop, fabricate, and test specialized instrumentation and measuring techniques, (3) determine the experimental biostatistical design, (4) collect anthropometric data on a statistically significant sample representative of the U.S. population for age groups from birth through 12 years, and (5) reduce, statistically analyze, and report the data in a format most usable and applicable to children's product safety design. In addition to these primary objectives, four subtasks were also completed: (a) publication of a handbook bringing together available pertinent previous studies and data on infant and child measurements for both U.S. and foreign sources [32]; (b) production and delivery of one 16-mm color movie providing preliminary information about how measurements are taken and illustrating instrumentation (8 minutes); (c) the design and conduct of a sub-study of infants between 3 and 6 months of age to provide appropriate information to safely restrain infants relative to crib slat interspaces; and (d) production and delivery of one 20 minute 16-mm color sound movie which describes and illustrates the overall study.

It should be noted that the summary data have been reported and submitted in two forms. In addition to this report which describes the measurements and instrumentation, background, and a statistical summary of the data in both tabular and graphical format, these data have also been submitted on digital computer magnetic tape (9-track 1600 BPI Standard Label) for use in further data analysis and retrieval with automated data systems.

## II. METHODS AND TECHNIQUE

### 1. Design of the Study

This study was initiated in April, 1972, under sponsorship of the Children's Hazards Division of the Bureau of Product Safety, Food and Drug Administration, and continued through 31 March 1975 by the Consumer Product Safety Commission, which was activated 14 May 1973. The need for a nationwide anthropometric study of infants and children had become evident by the predecessor National Commission on Product Safety, and preliminary discussions for planning such a study had been initiated with that group in 1969. Although there is an extensive literature reporting infant and child anthropometry, the bulk of the available data relate to measures of height (crown-heel), weight, and a few traditional dimensions useful to pediatricians, anthropologists, and others studying child growth. However, for designers of consumer products, developers of Federal Safety Standards, or other groups needing specific child body size data, the literature does not provide the functional data necessary. The only exceptions to date have been several studies described in the preceding section, mainly related to furniture, seating, or clothing requirements. The National Health Survey of the Public Health Service, which has provided the best data to date, also fails to include sufficient functional measurements due to limitations in time, anthropometry being only one of a series of examinations conducted. The purpose of the present study was to collect representative-population data most needed for application to product design on a population representative of the U.S.

Toward this purpose, initial discussions were held with representative manufacturers, Consumer Product Safety Commission and National Bureau of



Standards representatives, and other professionals experienced in applied anthropometry and design requirements. As a result, many of the measurements represent new information not previously available for infants or children. Several measurements were for direct application to specific problem areas. For example, infant buttocks depth was determined to be the most critical measurement for application to safe crib-slat interspace design; crotch height may be useful for bicycle frame height determination; and minimum hand clearance is a unique dimension needed for determining what size openings a child or infant can squeeze a hand through. Similarly, selected finger dimensions and inside and outside grip diameters represent functional types of measurements not previously available.

As often occurs in studies involving innovation and new techniques, the experimental design evolved during the initial phases. It was modified from the original plan of a straight-forward anthropometric survey by the discovery that the objectives could not be accomplished by traditional techniques. The basis for this is the difference in anatomical structure and morphology between the infant, child, and adult (Burdi, et al. 1973) [50]. In the adult measurements may be taken with standard anthropometry instruments with great accuracy and reproducibility by trained and experienced specialists, utilizing recognized skeletal landmarks. The results of measurements taken on different populations, measured by different measurers, may often be compared with great confidence in adult populations. However, this is not so in the case of sub-adults primarily due to two important physical differences in the subjects. In young children and especially infants, the body may be characterized by more extensive soft tissue. Bone growth is not completed for some important features of the skeletal framework until age 18-20 in boys and 17-19 in girls, or later, including union of important epiphyses (distal epiphyses of radius, ulna, tibia and fibula, acromion and femur, head and greater tuberosity to the humerus

proximal epiphyses of tibia and fibula). Thus the standard skeletal landmarks (distal portions or points involving tubercles or body projections may not yet exist in the largely cartilaginous structure of younger children. These two factors combine to make accurate and reproducible measurements for some dimensions difficult, if not meaningless, for even the professional anthropometrist. The question of how much pressure to exert on the soft tissue of an infant makes such measurements very subjective when attempted with standard anthropometric instruments. For these reasons, the initial plan was modified to extend the period needed to design, fabricate, test and develop the basic measurement tools found necessary.

The study had been designed as a multi-disciplinary program, with co-investigators initially representing the fields of physical anthropology (Dr. Snyder) and pediatrics (Dr. Spencer), augmented by faculty consultants from the Center for Human Growth and Development and Anthropology (Dr. Garn), the Department of Biostatistics, School of Public Health (Dr. Schork), Developmental Anatomy, Medical School (Dr. Burdi), and outside consultation with physical anthropologists Dr. McConville (Webb Associates) and J. Young (Civil Aeromedical Institute, FAA). Subsequently two additional co-investigators joined the study as the need for their specialized (and broad) talents became evident. Dr. Owings, a specialist in minicomputers, holds joint professorial appointments in the Department of Electrical and Computer Engineering, College of Engineering, and in the Department of Pediatrics, School of Medicine; while Dr. Schneider, a bioengineer, is a researcher in the Biomedical Department, the Highway Safety Research Institute. A large number of additional scientists and specialists also made substantial contributions to the program, as noted in the acknowledgements. This teamwork greatly enhanced the professional conduct of the study, which would have been difficult to accomplish as a single disciplinary research effort.

Originally, a sample size of 3000 had been projected. However, the data collection period was extended to allow a total population of 4,000 subjects to be measured from birth (two weeks) to age 13. In all, children were measured at 76 different locations. As noted in Appendix A, geographical locations included schools, day care centers, nurseries, and clinics in Florida, Massachusetts, Ohio, Connecticut, Oregon, California, Arizona, and Michigan. Determination of geographic locations, ethnic and racial affiliations, and socio-economic criteria was important in order to assure a representative nationwide population sample, and was projected by use of HEW and census data guidelines. However, as a practical matter, the theoretical projections never work out in the field situation exactly as anticipated and it was necessary to continuously make adjustments as the study progressed.

For example, after projected locations were determined from census data on racial and socio-economic composition of the population and other factors at various age levels, specific information concerning all the schools in the district, including racial and socio-economic breakdowns for each individual school was generally obtained. The particular schools at a location (such as Worcester, Mass., or Sacramento, Calif.) could then be selected to provide the best population sample cross-sections desired. However, even knowing the specific student composition of a school would not ensure that the children actually measured were as projected, since measurements were taken in the public schools only by informed written consent of parents, and it could not be determined beforehand which potential subjects would respond. Also, even though a parent had signed a consent form, there was no guarantee that the child would consent to be measured as, at older ages (particularly for boys), peer actions often were observed to be an influence. At several projected locations unforeseen events forced changes in the original biostatistical

design. For example, Memphis, Tennessee had to be omitted when disastrous tornadoes struck the city just prior to our scheduled arrival; and Manhattan, Kansas was also omitted due to a teacher's strike. Nevertheless, even with continuous adjustments in the strategy of the design of the field work, the outcome was close to that projected as representative.

The HEW racial guidelines indicate that 11% of the U.S. population is Black. Data obtained from questionnaires (Figure 1) used in this study indicate about 10% Black, 86% White, 2% Mongoloid, and 2% of mixed racial parentage. Unfortunately, HEW fails to indicate any definition of the term Black (which is defined differently in legal and biological terms) or any other racial affiliation. In some locations the term "Negro" had to be substituted for "Black" and vice versa, as one or the other would be locally unacceptable. Few people seemed to understand the anthropological terms "Negroid", "Caucasoid", and "Mongoloid", and so the early version of the form was changed to read as shown in Figure 2. Also, the economic grouping from data provided by the Institute for Social Research (i.e. family income) proved to be a non-responsive item (See Figure 1) and it was removed from the later forms (Figure 2). The term "Oriental" in the later forms included American Indians. To assist in areas of the Southwest where Spanish was spoken in homes more often than English, some forms were made bi-lingual. An example of the form used in Tucson and some schools in Sacramento is shown in Figure 3.

Included with the questionnaire given to the parents were a parental consent form (Figure 4) and a letter explaining the purpose and importance of the study (Figure 5). These forms were also printed as bi-lingual for certain areas of the country as shown.

CHILD MEASUREMENT STUDY  
Highway Safety Research Institute  
Ann Arbor, Michigan 48105

Child's name \_\_\_\_\_

Address \_\_\_\_\_

Child's birthdate \_\_\_\_\_ Male

Female

Child's Race: \_\_\_\_\_

Mother's Occupation: \_\_\_\_\_

Father's Occupation: \_\_\_\_\_

Mother's Race: Negroid  Mongoloid  Caucasoid   
Other  Please specify \_\_\_\_\_

Father's Race: Negroid  Mongoloid  Caucasoid   
Other  Please specify \_\_\_\_\_

Mother's Education: 8 yrs. or under  9-12 yrs.  More than 12 yrs.   
Completed college  More than 16 yrs.

Father's Education: 8 yrs. or under  9-12 yrs.  More than 12 yrs.   
Completed college  More than 16 yrs.

Yearly Income: Please circle the Number -- 1,2,3,4-- that indicates your annual family income.

1 - \$4000 or under

2 - \$5000-9000

3 - \$9000-12,000

4 - \$12,000 or more

Number of brothers \_\_\_\_\_ Number of sisters \_\_\_\_\_

What is the birth order of this child in relation to brothers and sisters? \_\_\_\_\_  
For Example: 1 - oldest, 2 - second oldest, etc.

Has the child been under treatment for any serious illness? \_\_\_\_\_

Figure 1. An initial questionnaire form. Subsequently changed to omit income question and use simpler racial terms.

CHILD MEASUREMENT STUDY  
Highway Safety Research Institute  
Ann Arbor, Michigan 48105

Name of School \_\_\_\_\_

Child's name \_\_\_\_\_

Address \_\_\_\_\_

Child's birthdate \_\_\_\_\_ Male

Child's Race: \_\_\_\_\_ Female

Mother's Occupation (job title) \_\_\_\_\_

Father's Occupation (job title) \_\_\_\_\_

Mother's Race: Black  Oriental  White   
Other  Please specify \_\_\_\_\_

Father's Race: Black  Oriental  White   
Other  Please specify \_\_\_\_\_

Mother's Education: 8 yrs. or under  9-12 yrs.  More than 12 yrs.   
Completed  More than college (16 yrs.)  16 yrs.

Father's Education: 8 yrs. or under  9-12 yrs.  More than 12 yrs.   
Completed  More than college (16 yrs.)  16 yrs.

Number of brothers \_\_\_\_\_ Number of sisters \_\_\_\_\_

What is the birth order of this child in relation to brothers and sisters? \_\_\_\_\_  
For Example: 1-oldest, 2-second oldest, etc.

Has the child been under treatment for any serious illness? \_\_\_\_\_

Figure 2. Final questionnaire utilized.

ESTUDIO DE LAS MEDIDAS DE NIÑOS  
Highway Safety Research Institute  
Ann Arbor, Michigan 48105

Nombre de escuela \_\_\_\_\_ Nombre del maestro(a) \_\_\_\_\_  
Nombre de niño(a) \_\_\_\_\_  
Dirección \_\_\_\_\_  
Fecha de nacimiento del niño(a) \_\_\_\_\_ Masculino   
Femenino   
Raza del niño(a) \_\_\_\_\_  
Empleo de la madre \_\_\_\_\_  
Empleo del padre \_\_\_\_\_  
¿Por cuánto tiempo ha vivido Ud. en esta comunidad? \_\_\_\_\_  
Raza de la madre: Negra  Oriental  Blanca   
Otra  Favor de especificar \_\_\_\_\_  
Raza del padre: Negra  Oriental  Blanca   
Otra  Favor de especificar \_\_\_\_\_  
Educación de la madre: 8 años o menos  9-12 años  Más de 12 años   
Completada educación universitaria  Más de educación universitaria   
Educación del padre: 8 años o menos  9-12 años  Más de 12 años   
Completada educación universitaria  Más de educación universitaria   
Número de hermanos \_\_\_\_\_ Número de hermanas \_\_\_\_\_  
¿Cuál es el orden del nacimiento de este niño en relación con los hermanos? \_\_\_\_\_  
Por ejemplo: 1-el mayor, 2-el segundo, etc.  
¿Alguna vez ha estado gravemente enfermo su niño(a)? \_\_\_\_\_  
Favor de explicar brevemente.

Figure 3. Questionnaire used for Spanish speaking people.

CHILD MEASUREMENT STUDY

Consent Form

I, the undersigned, understand that the purpose of this study is to take some measurements of my child. I am aware that these measurements will enable us to acquire information about the physical shapes of children at different age levels and to use this information in constructing guidelines for the safer design of children's products.

I have been informed that there will be no health hazards or discomfort to my child associated with this, and that participation is voluntary. In order to take measurements with accuracy, it is necessary for the child to partially undress, leaving on his/her underwear. Each child is measured individually, and all steps are taken to insure privacy.

I further understand that all of the data is confidential and I agree to allow publication of any or all of the data collected on my child if presented in a coded form.

\_\_\_\_\_  
Child's Name

\_\_\_\_\_  
Signature of Parent

\_\_\_\_\_  
Date

Figure 4a. Sample parental informed consent form - English.



ESTUDIO DE LAS MEDIDAS DE NIÑOS

Formulario de Permiso

Yo, el infrascrito, comprendo que el propósito de este estudio es tomarle algunas medidas a mi niño. Estoy enterado de que estas medidas darán la oportunidad de adquirir información de las formas de niños de varias edades y de utilizar estos informes en la construcción de normas para el diseño más seguro de productos para niños.

Me han informado que no habrá ni peligro de salud ni incomodidad a mi niño por causa de este estudio, y que la participación es voluntaria. Para tomar medidas con precisión, es necesario que el niño se quite parte de su ropa, quedándose vestido de ropa interior o de traje de baño. Se mide cada niño individualmente, y se hace todo lo posible para asegurar que se haga en privado.

Comprendo además que todos los datos son confidenciales y consiento en la publicación de unos o de todos los datos adquiridos de mi niño si se los ponen en cifra.

Nombre de niño(a)

Firma del padre o de la madre      Fecha

Figure 4b. Sample parental informed consent form - Spanish

HIGHWAY SAFETY RESEARCH INSTITUTE

Institute of Science and Technology

Huron Parkway and Baxter Road

Ann Arbor, Michigan 48105

THE UNIVERSITY OF MICHIGAN

(313) 763-3582

Dear Parent:

The Highway Safety Research Institute and the Department of Pediatrics of the School of Medicine at the University of Michigan are jointly conducting a study of infant and child body sizes. We are measuring children from age 2 weeks to 12 years, and we have made arrangements to measure children at your child's school during regular school hours.

This research is being sponsored by the Children's Hazards Division of the Bureau of Product Safety, Consumer Product Safety Commission. Through this study we hope to determine the physical size and shape of children which will provide basic size data to be used by the government as guidelines for standards related to the safer design of children's products. This would include children's furniture, playground equipment, car seats and restraints, toys, bicycles, etc. By the project's end, we plan to have measured 4,000 children. Our sample is designed to statistically reflect the total U.S. population of children according to the U.S. Public Health Survey.

The measurement team consists of 2 experienced research assistants with specialized measuring equipment. The actual measurements are taken with highly modified instruments designed for children. We take 38 measurements on each child which require about 15 minutes. The equipment is interesting to the children and they usually find that being measured is an enjoyable experience. Our protocol has been approved by the University of Michigan Human Use Committee of the Medical School.

The importance of obtaining these data is that no valid measurements presently exist for the majority of child dimensions necessary for proper safe design of children's products. This is the first attempt to obtain these measurements on a nationwide basis and the results will have a number of direct and basic applications in improving child products as well as in forming a valid framework for governmental standards. As one example of the importance of these measures, our measurements of 3- to 6-month old infants formed a basis for the government's recent issuance of safer crib standards, reducing slat interspaces from 3-1/2" to 2-3/8" to prevent the hazard of infants sliding through the side.

We have included a brief questionnaire with this letter. Because our sample will reflect the total U.S. population of children, we need to ask questions about race, education, and occupation. This information is strictly confidential and will be coded to insure anonymity.

Thank you for your cooperation.

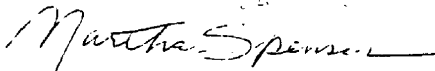

Martha Spencer, M.D.  
Department of Pediatrics

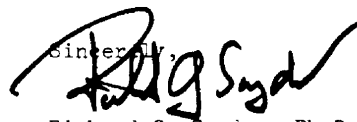

Sincerely,  
Richard G. Snyder, Ph.D.  
Head, Biomedical Department  
Research Scientist

Figure 5a. Sample letter explaining project - English.

HIGHWAY SAFETY RESEARCH INSTITUTE

Institute of Science and Technology

Huron Parkway and Baxter Road

Ann Arbor, Michigan 48105

(313) 763-3582

THE UNIVERSITY OF MICHIGAN

Estimados padres:

El Instituto de Investigaciones de la Seguridad de Carreteras (Highway Safety Research Institute) y el Departamento de Pediatría de la Facultad de Medicina de la Universidad de Michigan juntos conducen un estudio del tamaño de bebés y de niños. Medimos a niños de edad de dos semanas a los doce años, y hemos hecho preparaciones para medir a niños a la escuela de su niño(a).

Estas investigaciones se patrocinan la Comisión de Seguridad de Productos de Consumidores (Consumer Products Safety Commission). A través de este estudio esperamos determinar el tamaño y la forma de niños, los cuales nos proporcionarán datos básicos de tamaño. El gobierno los utilizará como normas para establecer reglas relacionadas al diseño más seguro de productos para niños. Estos incluyen muebles de niños, equipo de campos de recreo, asientos de automóviles y restricciones, juguetes, bicicletas, etc. Este año esperamos medir a unos 3,000 niños. Nuestro muestreo está diseñado para estadísticamente reflejar a la población total de niños de los Estados Unidos según un estudio del Departamento de la Sanidad Pública de los E.E.U.U.

Dos asistentes de investigación con experiencia toman las medidas con instrumentos sumamente modificados y contruidos específicamente para niños. Le tomamos 38 medidas a cada niño, las cuales duran unos quince minutos. Los instrumentos les interesan a los niños y por lo regular les parece agradable ser medidos. Nuestra manera de obrar ha sido aprobada por el Comité del Uso de Humanos de la Facultad de Medicina de la Universidad de Michigan.

Es importante obtener estos datos porque ahora no existen medidas válidas para la mayoría de dimensiones de niños necesarias para el diseño propio y seguro de productos de niños. Ésta es la primera vez que se trata de obtener estas medidas por todo el país y los resultados tendrán varias aplicaciones básicas y directas tanto en el mejoramiento de productos de niños como en la formación de normas para el establecimiento de reglas gubernativas. Un ejemplo de la importancia de estas medidas es nuestro estudio del tamaño de bebés de tres a seis meses de edad, cuyas medidas formaron la base de las normas que recientemente promulgó el gobierno para la mayor seguridad de las cunas. Se redujo la distancia entre las tablillas de 3 1/2 pulgadas a 2 3/8 pulgadas para evitar que los bebés se deslicen por las tablillas.

Un cuestionario breve se incluye con esta carta. Porque nuestro muestreo na de reflejar a la población total de niños de los Estados Unidos, es necesario que les hagamos preguntas acerca de su raza, su educación, y su empleo. Esta información es absolutamente confidencial y la pondremos en cifra para asegurar que quede anónima.

Les agradecemos su ayuda y su cooperación.

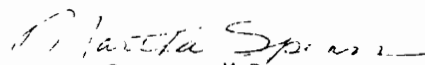
  
Martha Spencer, M.D.  
Departamento de Pediatría

Atentamente  
  
Richard G. Snyder, Ph.D.  
Jefe, Departamento Biomédico

Figure 5b. Sample letter explaining project - Spanish.

## 2. Procedure at Measurement Sites

Once a geographic location had been decided upon, initial contacts were by telephone, personal visits of a co-investigator, and/or written correspondence. At that time listings of all schools (with background information), child care centers and nurseries, and well child clinics in the area were obtained. In most nursery schools and day care centers the director had the authority to accept or reject the study, while in public schools the Superintendent of Schools usually presented our request to a School Board Committee. In some cases this would be a research committee, requiring a personal presentation. In our experience, rejections were rare, but understandably occurred under conditions such as being too close to the end of the school year, when the study would interfere with scheduled activities. In one case, a Public Health study had taken over all available space. In general, it took several weeks to obtain permission for public schools. Once the study was approved by the Superintendent of Schools or School Committee, specific schools were selected on the basis of the particular student makeup of the various schools (socio-economic, racial, and area) and the availability of a room of suitably private space for measuring. Often sites at widely scattered locations within a city were chosen. It was then necessary to contact and obtain approval from the principal of the selected schools, and this often was followed by making a presentation to the faculty of the chosen schools. These presentations also were beneficial, in that teachers having a clear understanding of the study would ensure a higher return of consent forms. At this point the three-page form (Figures 1-5) consisting of a letter to parents explaining the project, a parental consent form, and a question form, were distributed to teachers, who subsequently parceled them out to students to be filled out and returned. Two or more days were usually required before forms

were returned, and this had to be taken into account in advance planning.

Each of two measurement teams consisted of two research assistants, each able to do the tasks of the other. However, an attempt was made for the same individual on each team to do the majority of the measuring, while the other recorded the data or operated the mini-computer, and assisted with the positioning of the subject for measuring. Besides being highly trained anthropometrists for the measurements selected, the female members of these two teams had considerable background either as former teachers or in child work, so that they could interact well with children, teachers, physicians, and parents. Team members were highly selected from over 80 applicants. While one team worked primarily in the Ann Arbor Area, the travel team utilized a specially modified Dodge maxi-van to carry the equipment (Figure 6). It is significant that although there were three flat tires and other minor problems

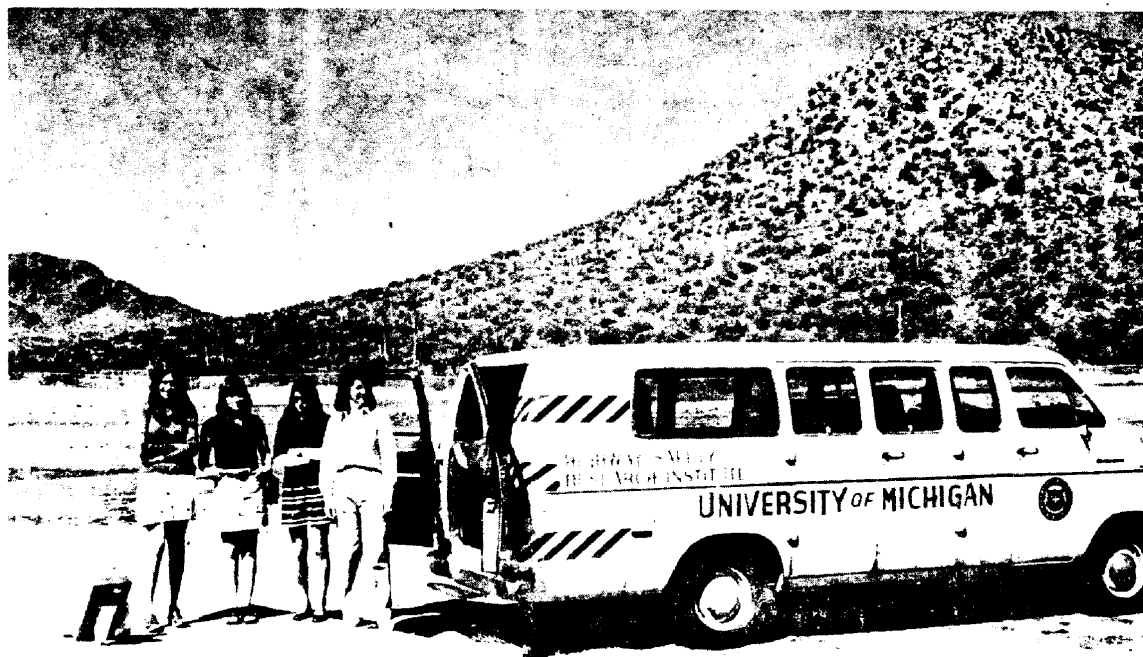

Figure 6. Modified Dodge Maxi-van used to carry equipment to the measurement sites.

with the van, the portable computer system endured the data collection phase of this study without a major breakdown, even though it often had to be moved in and out of buildings on a daily basis.

The measurers found that the children responded more positively to the study if it was explained fully to them before they took the letter forms home to parents. Therefore, wherever possible they went from class to class with the instruments and demonstrated the measuring process, answering questions, and explaining the purpose of the study. Response was found to increase proportionately to the amount of time spent briefing the children.

Infants were generally measured either at the University of Michigan well-child clinic or at the Highway Safety Research Institute in Ann Arbor, and at various clinic locations elsewhere. The procedure differed from that of nursery schools or public schools in that the participating parents filled out the questionnaire and consent form at the time of measuring and no preliminary distribution of forms was necessary.

The travel team had to be flexible and make numerous decisions relative to their measurement schedule upon arrival at their destination. Often, it was necessary to improvise in order to collect the most data possible in a short period of time. Since many schools did not open until 9:00 and let out for the day by 3:00, it was important to utilize the available measurement time as efficiently as possible. By using a system of periodic summary data tabulations for race, age, and other criteria, the measurement teams were able to balance the subjects measured to ensure approximate proportions of the projected experimental design as they went along.

### 3. Measurement Procedures

Most frequently, and ideally, the measurement team worked in a private room, which often was a nurses office or unused classroom in schools, or a partitioned-off room in nursery schools and day care centers. It was critical that the measurer and recorder worked closely and compatibly together as a team. The procedure generally went as follows:

A single child was brought from his classroom into the measuring room. The measurer instructed or helped the child to remove his/her clothing, leaving on underwear, while the recorder "processed" the questionnaire data for that child. Each task took approximately the same amount of time. The measurer then measured the child with the aid of the recorder. As the child was dressing after being measured, the assistant measurer or recorder would go to a classroom to get another child. By the time they returned to the measuring room, the first child was usually dressed and the process started anew. Younger children often liked to be taken to the measuring room in pairs and this quickened the process somewhat. For the most part, however, the above system proved to be the most satisfactory to the measurement team and to the children participating.

When measuring infants at clinics, a member of the team would simply approach the parent, explain the project, and either obtain approval or not. As privacy is not an all-consuming concern of the very young, and as clinics rarely have a room to spare, clinic lobbies, hallways, or semi-private rooms were often used for these subjects.

Even in the best of circumstances a constant flow of children for measuring was not possible, as the measurement team had to work around the schedules of the school in which they were working. Recesses, naps, and

special assemblies were among the interruptions to a daily measuring schedule. On a good day the teams averaged 16 to 20 subjects.

Individual subject consent and questionnaire forms were filed by subject number and computer number for children measured by the automatic data acquisition system.

#### 4. Inter- and Intra-Measurement Tests

During the course of the study two procedures, with variations, were utilized to ensure measurement reliability and consistency. Periodically, members of the two measurement teams would measure the same children and/or infants. They were informed that the results would be analyzed to determine if any specific measurements were giving problems, and to check on technique. Since this also provided a good opportunity to identify any divergences in measurement technique; each was observed and aware that it was a procedural check. In these instances measurements were taken independently in turn by each measurer on each child. However, measurers were also encouraged to periodically check themselves by making multiple measurements on the same individual, with a period of time or other measurements intervening.

A second and more critical technique involved checks on the measurers without their knowledge. This was often difficult to do, since the team would have approximately 20 minutes of contact with each child, providing time for some rapport to build up so that for a considerable time they could recognize children previously measured. Infants were the easiest to make substitutions for without suspicion, but were very difficult to arrange for, since two or more "mothers" would have to be involved. The most successful checks occurred during a period when a large series of twins were being measured for



a concurrent strength study. In these instances multiple substitutions were possible, using a non-twin, which would be measured on two separate occasions by each team. This procedure was also difficult to set up, since the subject had to be carefully briefed. However, the technique presented an excellent opportunity to make both inter- and intra-measuring comparisons.

Statistical analysis of these tests was provided by the Department of Biostatistics, and paired t-tests were conducted. It was concluded for the "twin" tests that there were no significant differences (at  $\alpha = .05$  level), each measurer was precise (same measurers on repeated trials) and consistent (same measurements found between measurers). However, because of the small samples involved, more extensive sampling would be desirable to thoroughly explore these observations. From these various procedures conducted during the data collection phase, the measurers appeared highly motivated and conscientious in the data taking.

##### 5. Measurement Devices and Automated Equipment

Automated Anthropometric devices have been suggested [78-79] and developed by Garn et al.[80] for use in odontometry, and at present work is being conducted using such techniques at the University of Queensland, Brisbane, Australia [81] by Bullock, and at the University of Nymegen, the Netherlands, by Prah-Anderson [82,83], among others. However, the current system in use by the University of Michigan is believed to be the most extensive systematic use of automated anthropometry, the first use of the NOVA minicomputer data acquisition system, and the first practical portable computerized means of obtaining C.G. measures on both children and infants. Detailed description of the measurement devices developed for use in this program have been previously published [84-88].

The task of measuring squirming infants and small children involves problems not present when measuring adults. Measurements must be taken quickly and efficiently without sacrificing accuracy; and if reproducibility of measurements on soft tissue is to be achieved, a means of standardizing these measurements must be provided. With infants and young children the lack of skeletal landmarks and the number of measurements that must be made on soft tissue make it especially difficult to achieve accuracy and reproducibility. For these reasons, it was decided at the outset that the development of new anthropometric measuring equipment utilizing an automatic data acquisition system would be necessary and critical if reliable data were to be obtained.

In order to obtain body segment lengths, GPM (Siber Hegner & Co., Ltd) Swiss standard anthropometers and calipers were modified to provide electrical readout of the length by means of a 10-turn potentiometer connected to the moving blade by means of a pulley and cable system. These instruments are illustrated in the drawings of Figures 7a and 7b, respectively. A miniature pressure transducer placed in the special plexiglass blade provides a means

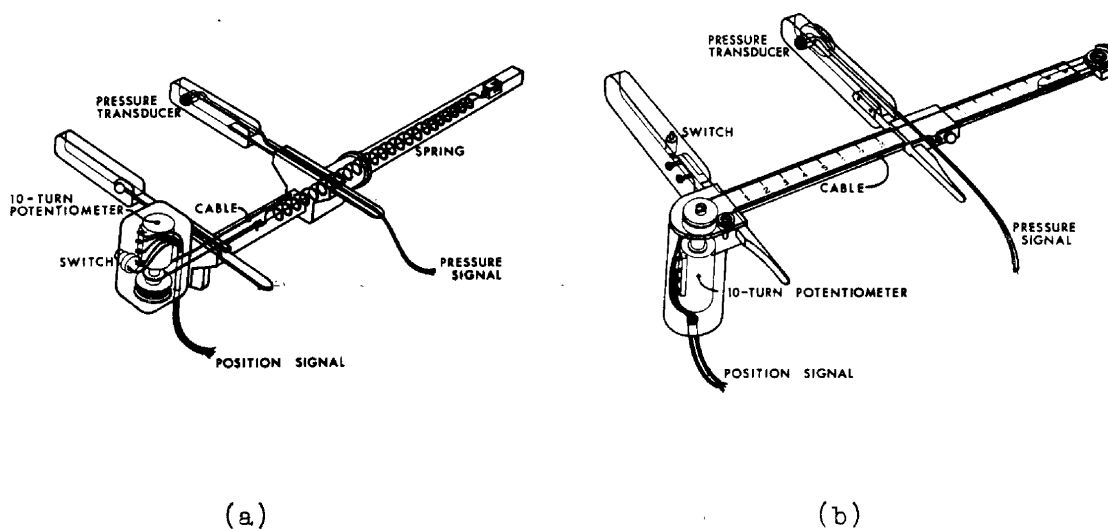
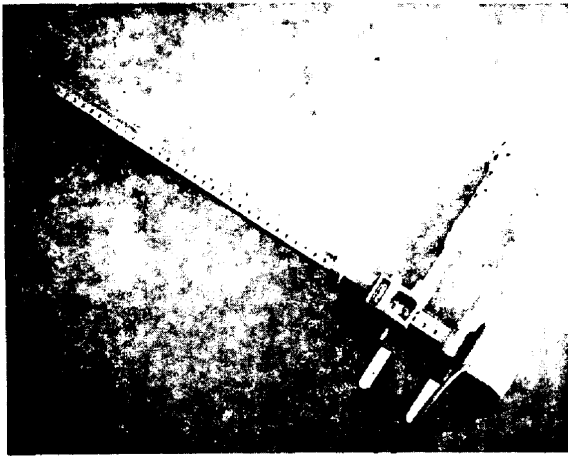
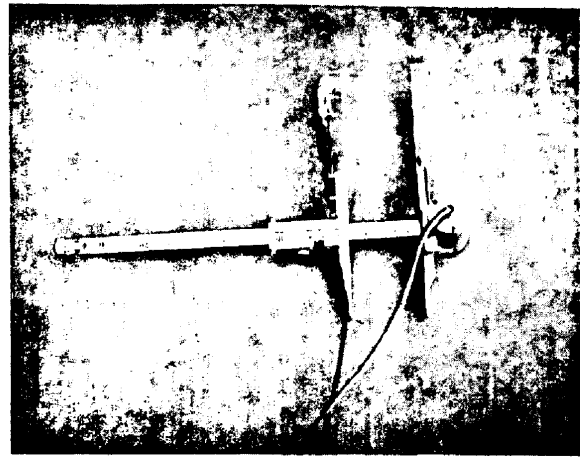

Figure 7. Drawings of modified anthropometer in (a) and modified sliding calipers in (b) showing potentiometer, pulley and cable system, and pressure transducer.

of standardizing the measurements on soft tissue by simultaneous recording of both length and pressure. Figures 8a and 8b show the actual instruments.



(a)



(b)

Figure 8. Photographs of modified anthropometer in (a) and modified sliding caliper in (b).

A third device to measure body circumferences, shown in Figure 9, also provides an electrical readout of the measure by means of a 10-turn potentiometer incorporated in the handle of the device. Tension in the loop of a standard measuring tape wound around a pulley is maintained and controlled by means of a

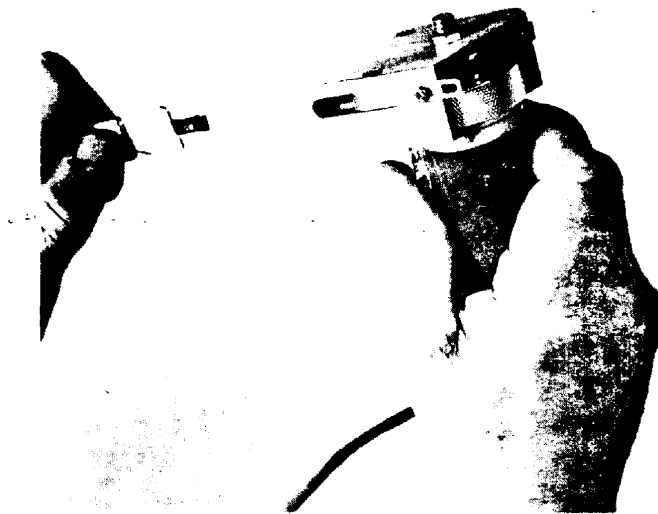

Figure 9. Modified girth device for electrical readout of circumference measurements.

coil spring in the device. To make a measurement the tape is looped around the body segment and clipped back on the device.

These devices are interfaced through a 12-bit A/D converter to a mini-computer data acquisition system, which consists of a NOVA 1220 mini-computer, two magnetic tape drives, a keyboard, terminal, and TV display unit contained in the portable package shown in Figures 10a and 10b. The

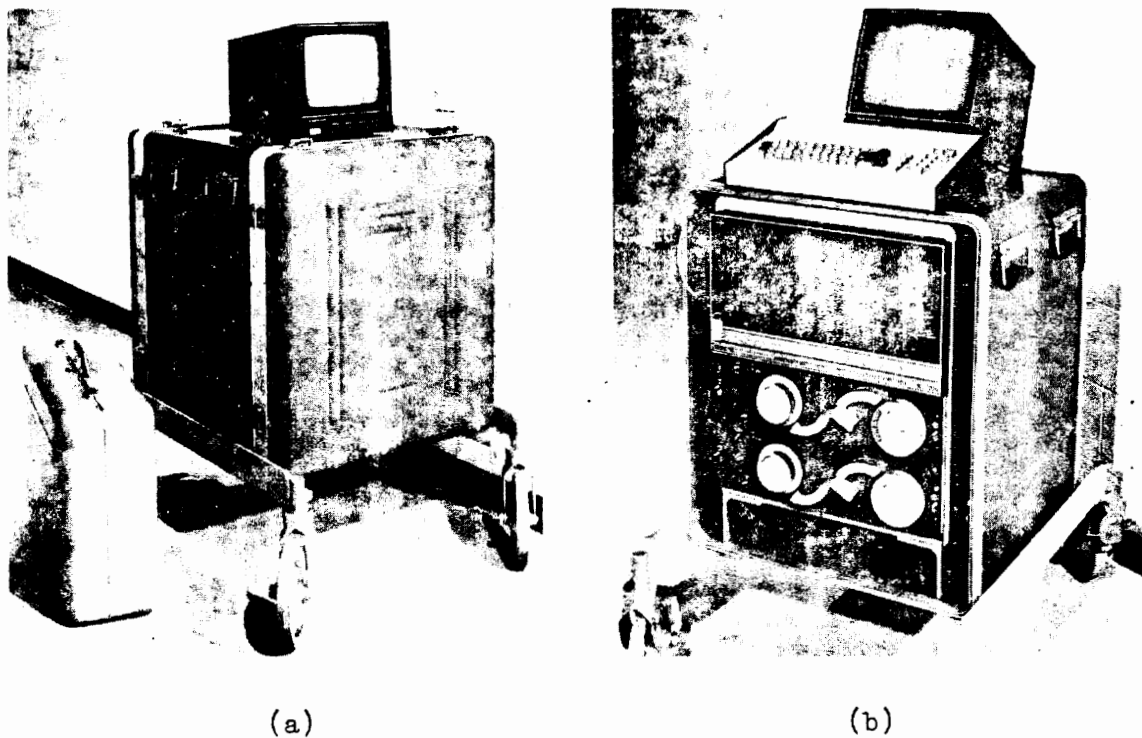

Figure 10. Nova 1220 portable mini-computer system shown ready for transport in (a) and with covers removed in (b).

pressure signals from the anthropometers and calipers are amplified by instrumentation amplifiers prior to the A/D converter. A program called MAP (Michigan Anthropometric Processor) (Figure 11) controls the measurement acquisition process, including daily instrument calibration, measurement



Figure 11. Keyboard and TV monitor showing initial display of MAP (Michigan Anthropometric Processor) program.

sequencing, information retrieval, and data storage on Linc tape. In addition to the measurement data, information related to the child's age, sex, race, etc., is obtained and input to the system via the keyboard.

A second method of data collection uses a portable instrument package which contains signal amplifiers and provides for length measurement readout on a digital meter and pressure readout on an analog meter. This system is advantageous for anthropological field measurements where cost and portability are critical, since the entire unit can be hand-carried by the measuring team (Figure 12). However, since the digital readouts must be recorded by hand, there is a greater chance of recording error. Further-

more, center-of-gravity measurements can only be obtained by the computer system.



Figure 12. Measuring team carry suitcase with measuring instruments and digital readout unit in Tucson, Arizona

In either system, measurements are transmitted by the instrument being used by depressing a button on the device. For measurements involving pressure, the computer system records a set of 20 lengths at 20 pressure values from 0 to 1 PSI during a pressure "squeeze" and displays the results in a graph on the TV display. For the purposes of this report, values at .5 PSI have been extracted from these data. For the meter readout system, measurements are read from the digital meter when the button on the instrument is depressed and when the needle on the analog meter points to the desired pressure (.5 PSI). These readings are recorded by hand and later keypunched to IBM cards. Data from the two systems have thus been combined and edited into a common file for the results of this report.

Devices for obtaining other measurements include a standard anthropometer for stature, sitting height, and sitting mid-shoulder height; measurement cones for inside and outside grip diameter measurements; templates for measuring finger diameters; and hinged hole boards for minimum hand clearance dimensions. Measurements from these devices are read directly and/or coded and input to the computer system via the keyboard. All the measuring instruments are contained and transported in a single case shown to the left of the computer in Figure 10a.

Instrumentation which allows for measuring whole body center of gravity has also been developed and interfaced with the computer system. Two separate devices have been designed, one for infants and one for children up to 220 pounds. The principle of operation of both is the same and is illustrated in Figure 13.

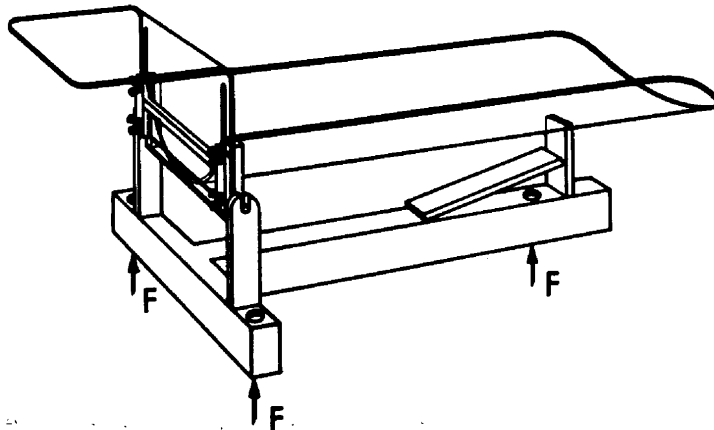
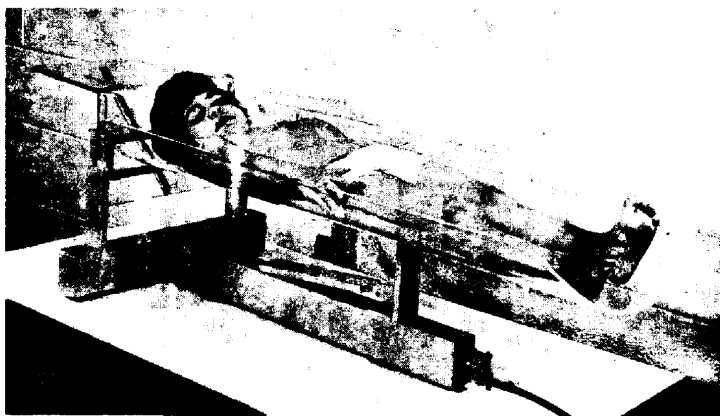

Figure 13. Drawing of infant center of gravity device indicating location of load cells and principle of operation.

A platform in which the child is placed is supported by three precisely calibrated load cells. Output signals from these transducers go to the

computer via instrumentation amplifiers and the A/D converter. By placing the subject against a known reference plane, the center of gravity is computed from the relative weights on the load cells. Subjects are placed both in the supine position for standing C.G. measures (Figures 14a and 14b) and in the supine position with the legs supported over a platform and knees at right angles for sitting position C.G. (Figures 15a and 15b). In this report, measures are reported as a percent of stature and sitting height, respectively. The infant device uses a plexiglass cradle to hold the infant, while the child device uses a flat rigid platform constructed of a light weight aluminum-styrofoam sandwich structure.



(a)



(b)

Figure 14. Infant c.g. device in (a) and child c.g. device in (b) showing subject in supine (standing) position.



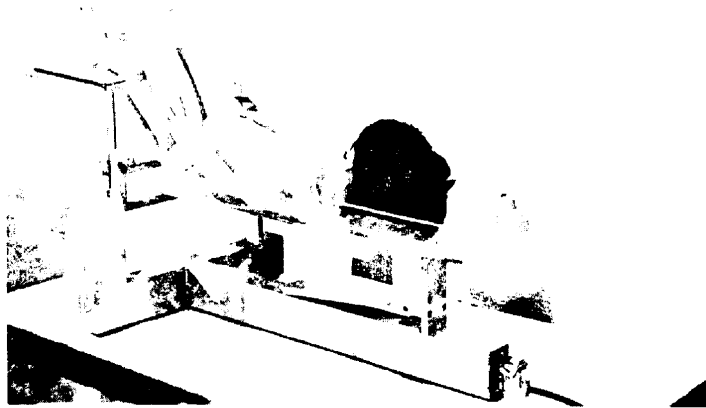

(a)

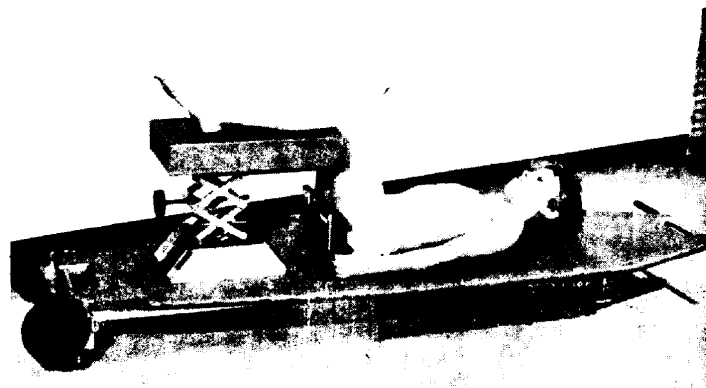

(b)

Figure 15. Infant c.g. device in (a) and child c.g. device in (b) showing subject in seated position with knee angle at  $90^{\circ}$ .

The entire package of equipment including computer system, measuring instruments, TV display, and center of gravity devices is portable and capable of being transported to measuring sites in a specially modified van. Special lightweight ramps have been designed to easily roll the computer cart in and out of the van (Figure 16) and other fixtures and straps are used to secure equipment in place during transport.

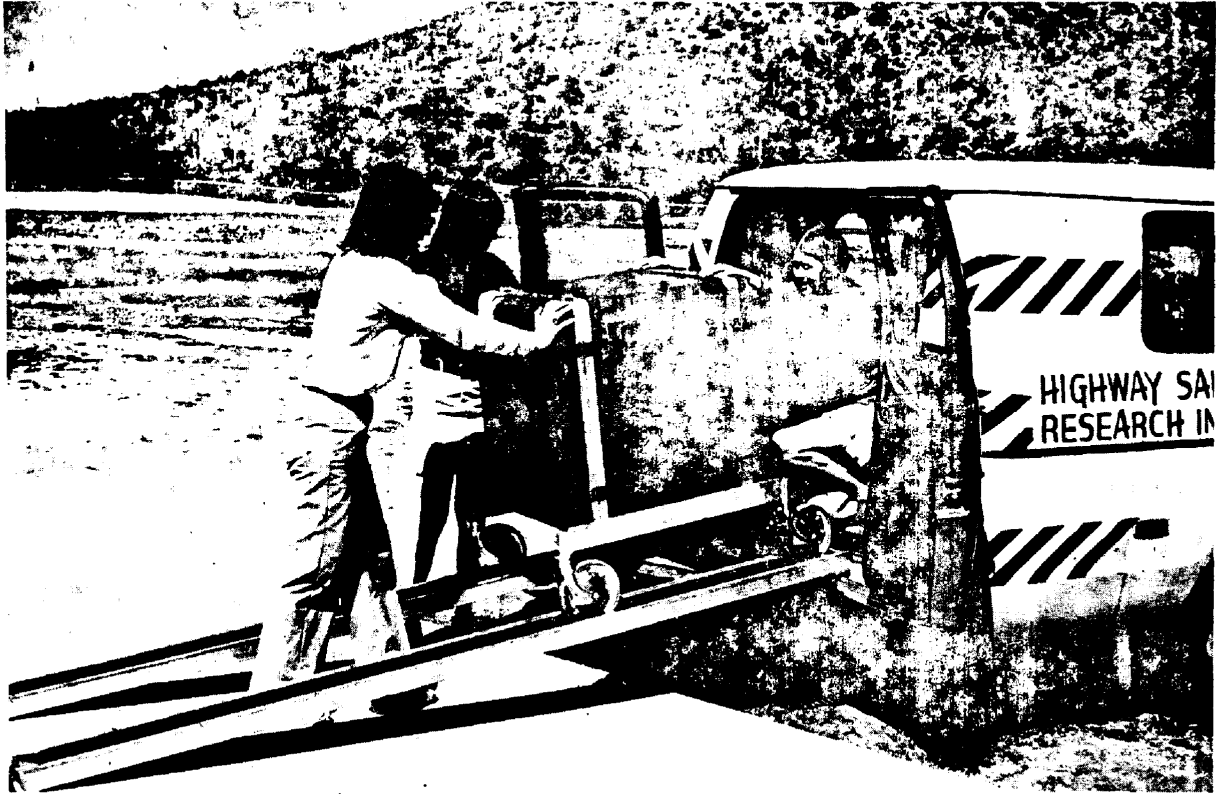

Figure 16. Measuring team unloading computer from van at measuring site.

## 6. Data Handling, Reduction, and Analysis

The results presented in Chapter IV were obtained from data acquired by both the computer system (i.e., stored on Linc tape) and the portable readout unit (i.e., recorded by hand on prepared forms). These data were edited and combined into a common file on the Michigan Terminal Computer System (MTS) from which the statistics were computed for each age group and each measure.

Data stored on Linc tape were transferred to MTS via a 1200 baud (bits/sec) Modem. These data include both coded and written interview data regarding the subject's race, age, socio-economic status, geographic location, etc., as

well as the measurement, pressure, and center-of-gravity data. Data recorded by hand were keypunched on IBM computer cards for input to MTS. These data include the socio-economic information on the subject which had been precoded as well as the measurement data. The primary difference between these two sets of data was in the pressure measurements. The Linc tape data contained 20 lengths at 20 pressures for some measurements, while the hand recorded data contained only a single length recorded at a pressure of .5 PSI. These files were made compatible by extracting a single measurement distance at the pressure value closest to .5 PSI in the Linc tape data, and the two files were then combined after editing each separately.

Editing was accomplished by using visual scans of frequency printouts for the measurement values in each age group and by running computer checks for size relations between different measurements on each subject. The former procedure involved examination of extreme values to determine the cause of their value (e.g., a bad measure, a wrong birthdate causing a wrong age computation, a recording error in the hand-recorded data, or an unusually small or large measurement). Printouts of each subject's data were available for determining the cause of the extreme values. The latter procedure involved checking the data on each subject for obvious impossibilities in the size of various measurements. For example, it is impossible for sitting height to be less than sitting mid-shoulder height or for rump-sole to be less than knee-height, etc. These and other relations were checked by computer and inconsistent relations and subject numbers printed out and investigated. After editing, the two files were combined and the statistical results compiled.

### III. RESULTS

#### 1. Description of Data Presentation

The following section presents the summary data for each of the 41 measurements. Although a total of 4027 infants and children were measured, the total  $N$  for some measurements is less because of incomplete measurement sets on individuals (as can occur with a crying, wriggling infant) and reductions due to data editing. For each measurement, the results are presented in an identical format, providing a technical description of how the measurement was taken together with a photograph and an illustration for both the infant measurement and the child measurement (since there may be differences in techniques even though the name of the measurement is the same). This is important for others who wish to conduct comparable measurements. In addition, both summary data tabulations and graphs are provided for males, females, and combined sexes, by age intervals as described in the next section. Information includes the size of the specific sample ( $N$ ), the mean ( $\bar{x}$ ), the standard deviation ( $\sigma$ ), and the 5th, 50th, and 95th percentiles. The latter tabulations have been found most useful for design problems, in cases where a product cannot be reasonably designed to accommodate the full range of a particular body size or dimension possible within the population.

Two measurements, hip depth and buttocks depth, were taken only on infants and children under 24 months. Three other measurements, neck circumference, crotch height, and sitting-mid-shoulder height were taken only on children over 24 months. As a result, the tables for these measurements contain fewer age groups since the ages not measured are excluded. Other measures, which have different names for infants than for children, such as crown-sole and stature, are combined into one table, under one name. For

purposes of this study an infant is defined as under 24 months.

## 2. Interpreting the Tables and Graphs.

The age groups for the tables are by months and the tables list the range of months for each group. For infants under 18 months the breakdown is by 3 month intervals (0-3, 4-6, 7-9, 10-12, 11-13, 14-16, and 17-18). From then on it is by 6 month intervals (19-24, 25-30, 31-36, 37-42, 43-48, 49-54, 55-60, 61-66, 67-72, 73-78, 79-84) until 84 months (7 years), after which the breakdown is by 12-month intervals (85-96, 97-108, 109-120, 121-132, 133-144, 145-156). There are, therefore, a total of 22 age groups for measurements where all ages were measured. For the two measures, hip depth and buttocks depth, which were taken only on infants (0-24 months), the breakdown is by 2 month intervals (i.e. 0-2, 3-4, 5-6, 7-8, 9-10, 11-12, 13-14, 15-16, 17-18, 19-20, 21-22, 23-24). In the column following the age in months for those months corresponding to interger numbers of years, the age in years is also given.

The particular group a child is in is determined by rounding the age in months off (up or down) to an integer month. (Using 15 days as 1/2 month). Therefore, if a child is 3 months and 16 days, the age will be rounded off to 4 months and the child's data will be placed in the 4-6 month age group. If the child were 3 months and 14 days when measured, the data would be in the 0-3 month age group. Similarly 108 months and 16 days = 109-120 month age group, 84 months and 13 days = 79-84 month age group, etc. For 15 days the age is rounded up. In other words each age group is bounded by the listed ages in months minus one half month.

Below each table, the results are presented graphically by three curves representing the 5th percentile, mean, and 95th percentile values of the

measurement. These graphs are intended only as a pictorial overview of the pattern of change across age intervals and were generated by a least squares fit of fourth order polynomials of the measurement variable ( $y$ ) in each age interval on the median ( $x$ ) of that age interval. Figure 17 illustrates the curves fitted to the data points for the waist circumference measurement and shows the manner in which the curves fit the data points. In order to present a less confusing picture, the data points have been omitted from the graphs in the data summary. It should be clearly indicated that these graphs are not intended for use in finding specific numeric values or statistical inferences. The tables are presented for this more precise and detailed interpretation.

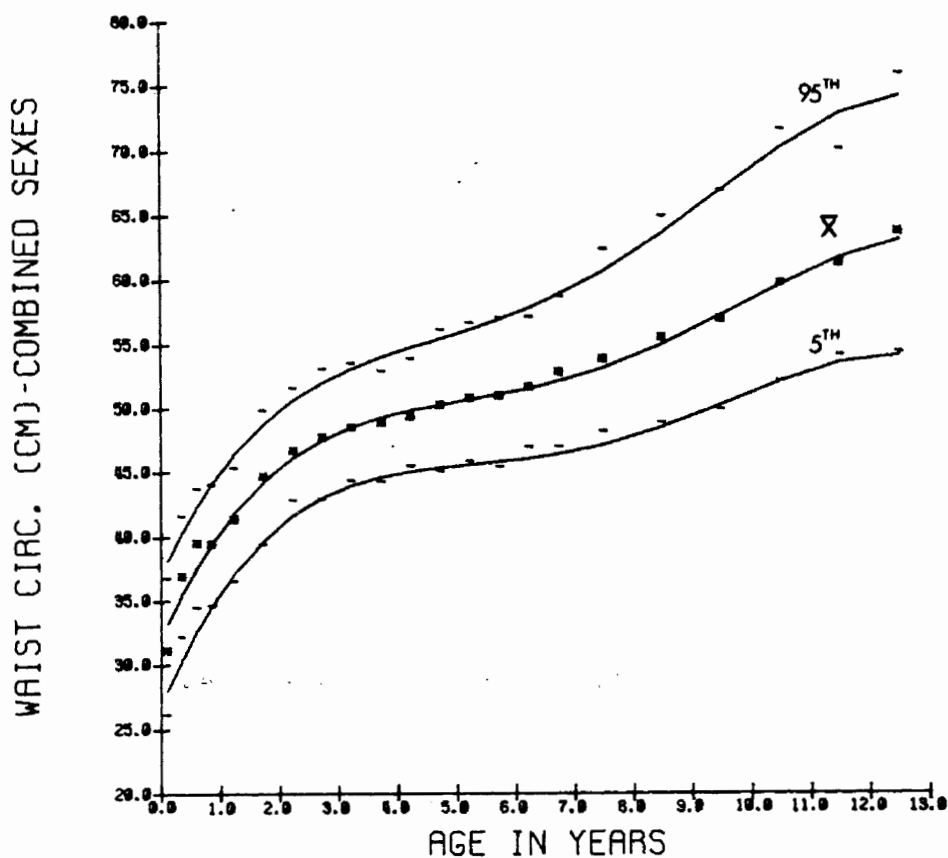

Figure 17. Calcomp plot of 5th and 95th percentiles and mean ( $\bar{x}$ ) data points for waist circumference measurement showing the least square fits of 4th order polynomials to these data.

It should also be noted that the graphs sometimes suggest anomalous values, particularly in the extremes for the 5th and 95th percentiles<sup>1</sup> (e.g., large 95th percentile and small 5th percentile) at low and high age groups . Caution should be used in extrapolating from these extremes as they are generally based on small sample sizes. If, for example the sample size is near or less than 20, then the 5th and 95th percentiles become the range, and if an extreme (1st percentile or 99th percentile) individual is in the sample the values may appear out of line with the rest of the graph. It is also true, however, that the least squares fit curves tend to smooth out such sampling errors (and other random errors) thereby presenting a more accurate picture of the true population than is represented by the tabulated data.

One further word of caution in utilizing these, or any other anthropometric data is suggested. There is no such thing as an "average" infant or child. That is to say, for example, that for a given age one cannot take the 50th percentile (median) measurement for the separate body segments which combine to make up stature, add them together, and come out with a "50th percentile" child in stature. This is due to the variation that exists in growth of childrens body segments (or "links"). An excellent discussion of the statistical basis for this is provided in Daniel's "The Average Man", 1952 [89]. Due to variability within individuals, there are relatively few dimensions that are highly correlated ( $r > .90$ ). How this effects the design of

---

1. The manner of computation for the 5th and 95th percentile values involves an interpolation between occurring values of the measurement which lie on either side of the percentile of interest. For example if a measurement value up to 6.5 includes 3 percent of the sample and the next higher value of 10.5 includes 7 percent of the sample, then the 5th percentile value is computed as  $6.5 + 4 \left[ \frac{5-3}{7-3} \right] = 8.5$

a workspace has been considered in a two-part publication by Moroney (1972) [90] and Smith (1972) [91].

### 3. Measurement Descriptions and Results

The following pages contain the measurement descriptions for the 41 measurements taken, each followed by three pages of tabular and graphical results for combined sexes, males, and females respectively. Since these measurements are grouped into similar types of measurements (e.g., depth, breadth, or circumference measurements, hand and foot measurements, etc.) rather than listed alphabetically, the following list is provided as an index to these results. The measurement name given in brackets refers to the name for infants if it is different than for the child.

<u>Measurement</u>	<u>Page</u>
<u>General Body Measurements</u>	
Weight	51
Stature [Crown-sole]	57
Sitting height	63
Sitting mid-shoulder height (child only)	68
Crotch height (child only)	72
<u>Body Link Length Measurements</u>	
Buttock-knee [rump-knee]	76
Knee height [knee-sole]	81
Buttock-foot [rump-sole]	86
Shoulder-Elbow length	90
Lower Arm length	94



<u>Measurement (Continued )</u>	<u>Page</u>
<u>Hand, Foot and Finger Measurements</u>	
Hand length	98
Hand width	102
Foot length	106
Foot breadth	110
Little finger length	114
Little finger diameter	118
Middle finger length	122
Middle finger diameter	126
Minimum hand clearance diameter	130
Inside grip diameter	134
Outside grip diameter	138
<u>Body Breadth Measurements</u>	
Head breadth	142
Maximum shoulder breadth	146
Chest breadth	150
Waist breadth	154
Lower torso breadth	159
<u>Body Depth Measurements</u>	
Head length	164
Chest depth	168
Buttock depth (infant only)	172
Hip depth (infant only)	176
<u>Body Circumference Measurements</u>	
Head circumference	180
Neck Circumference (child only)	184
Chest circumference	188

<u>Measurement (Continued )</u>	<u>Page</u>
Waist circumference	192
Forearm circumference	196
Upper arm circumference	200
Mid-thigh circumference	204
Max. calf circumference	208
Ankle circumference	212
<u>Center of Gravity Measurements</u>	
Standing c.g. - % stature	217
Sitting c.g. - % sitting height	223

## WEIGHT (INFANT)

Device: Clinic scale and/or infant center of gravity device. The measurement obtained from the scale is typed into the computer via the keyboard. This result is compared with the weight calculated from the readings of the three load cells on the center of gravity device (see center of gravity measurement).

Description: INFANT: The infant is weighed on clinical scales to the nearest tenth of a kilogram and/or placed in the plexi-glas cradle of the center of gravity device from which the weight is computed automatically by the computer.

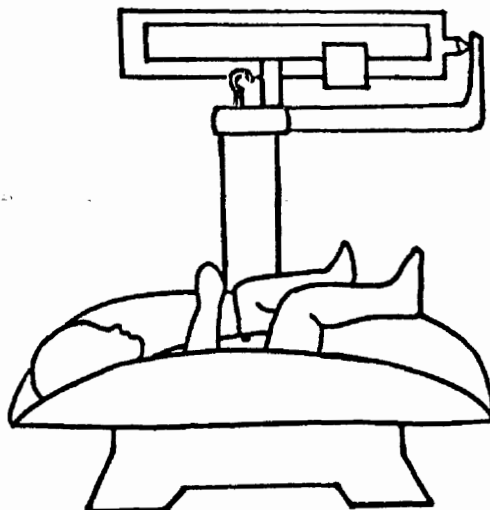
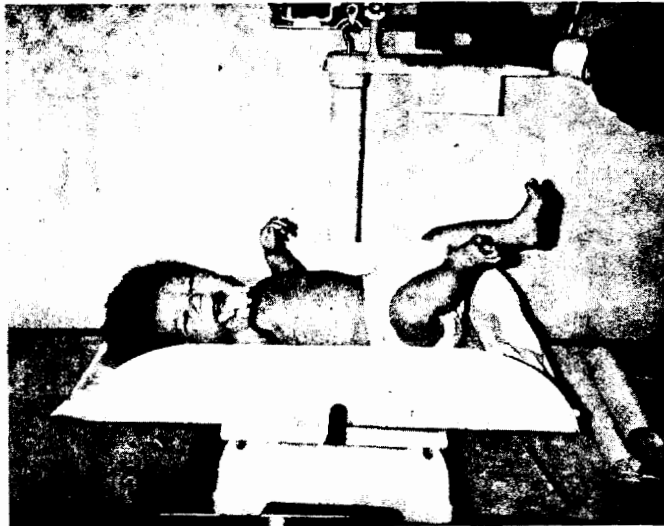

## WEIGHT (CHILD)

Device: Health-O-Meter metric scale and/or child center of gravity device. The measurement obtained from the scale is typed into the computer via the keyboard. This result is compared with the weight calculated from the readings of the three load cells on the center of gravity device (see center of gravity measurement).

Description: CHILD: The child is weighed on clinical scales to the nearest tenth of a kilogram and/or placed horizontally on the child center of gravity platform from which the weight is computed automatically by the computer.

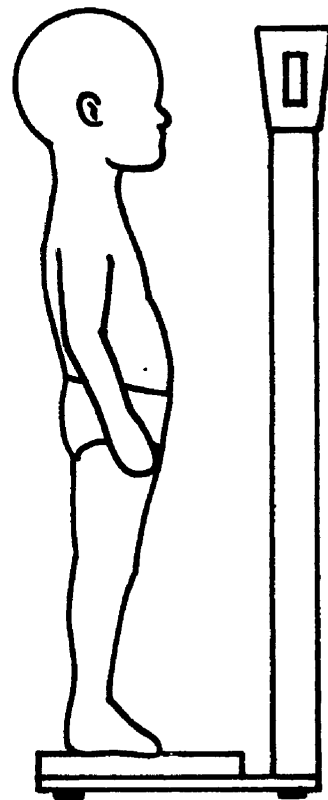
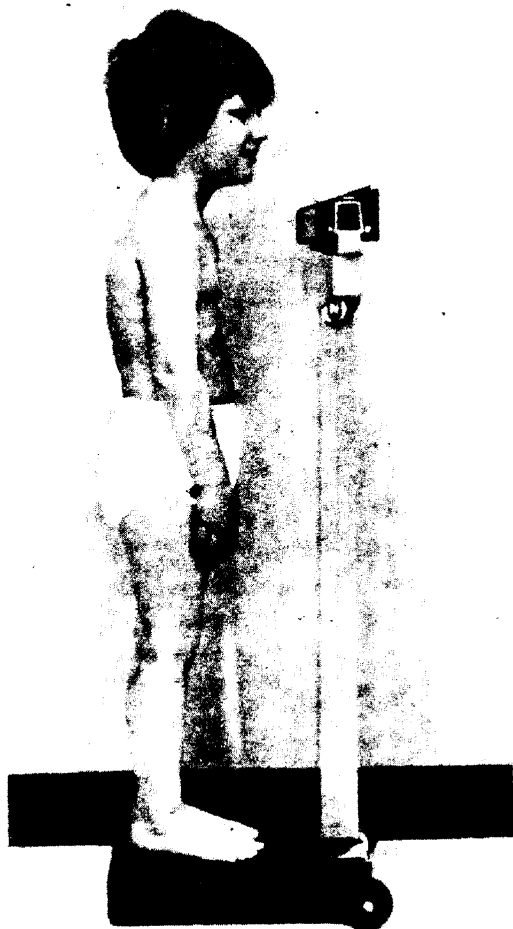

WEIGHT, IN KGS. - COMBINED SEXES

AGE(MO/YRS)	N	MEAN	S.D.	5%	50%	95%
0- 3	127	4.7	1.1	3.1	4.4	6.7
4- 6	84	7.0	1.0	5.4	6.9	8.5
7- 9	49	8.3	0.8	6.5	8.3	9.6
10- 12	1	41	9.2	1.1	7.5	9.2
13- 18	47	10.2	1.2	8.2	10.1	11.9
19- 24	2	51	11.8	1.2	10.1	11.7
25- 30	54	12.9	1.4	10.7	12.8	16.1
31- 36	3	64	13.5	1.5	11.0	13.2
37- 42	157	14.9	1.7	12.3	14.8	17.5
43- 48	4	163	15.6	1.8	12.6	15.3
49- 54	203	16.8	1.9	13.9	16.5	20.3
55- 60	5	181	18.0	2.2	14.4	17.7
61- 66	175	19.1	2.7	15.6	18.5	23.8
67- 72	6	150	20.1	2.9	15.4	20.1
73- 78	162	21.0	2.8	16.7	20.8	25.8
79- 84	7	156	22.4	3.0	17.9	22.2
85- 96	8	248	24.7	4.3	18.9	24.0
97-108	9	262	27.7	4.9	21.1	26.9
109-120	10	260	30.5	5.5	22.9	29.4
121-132	11	211	34.9	6.5	25.7	34.1
133-144	12	116	38.5	6.9	28.9	37.3
145-156	50	44.9	8.4	33.1	43.9	57.7

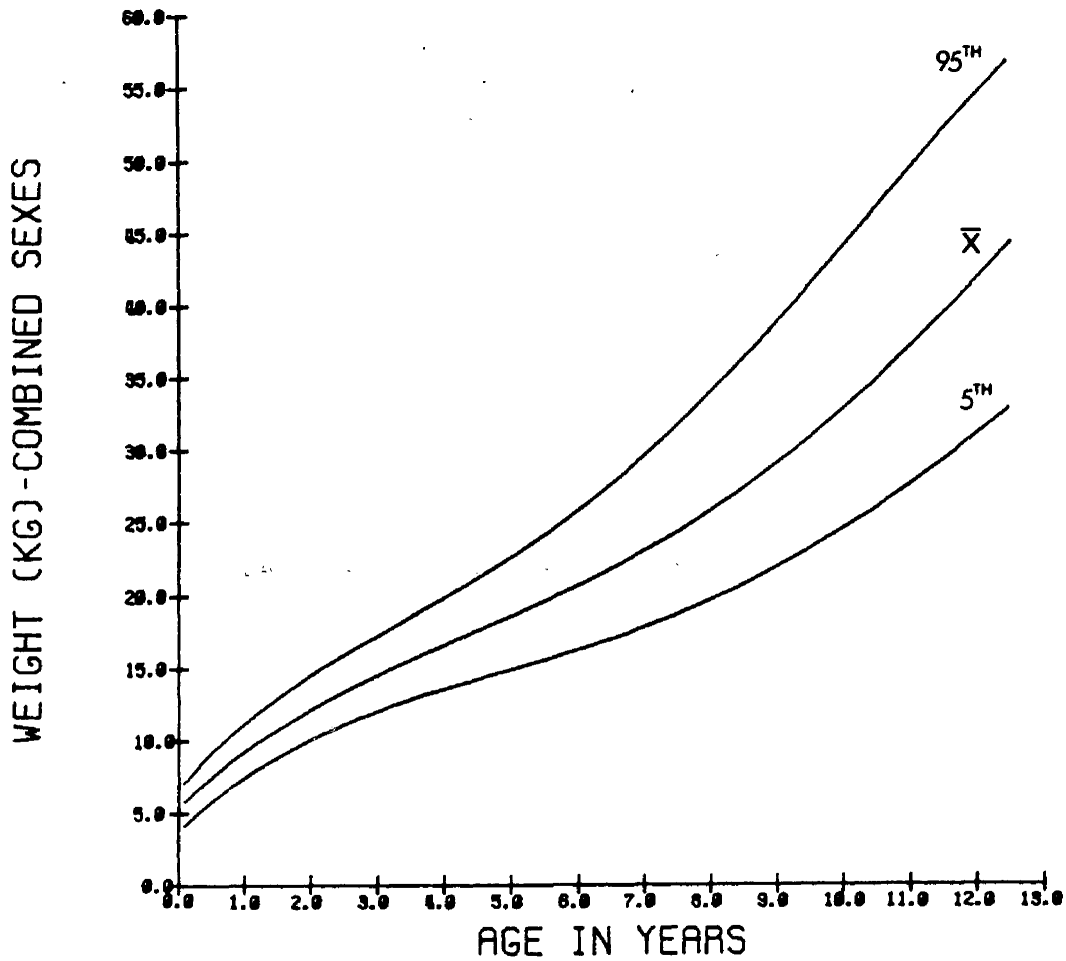

WEIGHT, IN KGS. - FEMALES

AGE(MO/YRS)	N	MEAN	S.D.	5%	50%	95%
0= 3	57	4.6	1.1	3.1	4.5	5.9
4= 6	44	6.7	0.9	4.7	6.8	8.2
7= 9	28	8.1	0.7	6.6	8.1	8.9
10= 12 1	22	8.9	1.3	6.4	8.8	10.6
13= 18	21	9.9	1.3	8.1	9.4	12.2
19= 24 2	18	11.2	1.1	10.0	10.8	14.0
25= 30	25	13.0	1.5	10.5	12.8	15.8
31= 36 3	30	12.8	1.1	10.6	12.8	14.4
37= 42	78	14.8	1.8	12.1	14.6	17.5
43= 48 4	91	15.4	1.8	12.5	15.1	18.6
49= 54	101	16.4	1.8	13.6	16.3	19.9
55= 60 5	96	17.7	2.3	14.0	17.6	21.2
61= 66	92	18.9	3.0	15.0	18.4	23.7
67= 72 6	71	19.3	2.7	15.2	19.1	23.2
73= 78	90	20.7	2.9	16.2	20.3	25.9
79= 84 7	82	21.8	2.7	17.2	21.8	26.0
85= 96 8	123	24.2	4.0	18.9	23.3	32.2
97=108 9	135	27.7	5.2	21.0	26.6	38.3
109=120 10	157	30.6	5.8	22.8	29.4	41.5
121=132 11	107	34.4	7.2	21.7	33.7	46.2
133=144 12	63	38.1	7.3	27.5	36.7	51.8
145=156 13	29	48.0	8.1	35.7	45.9	59.7

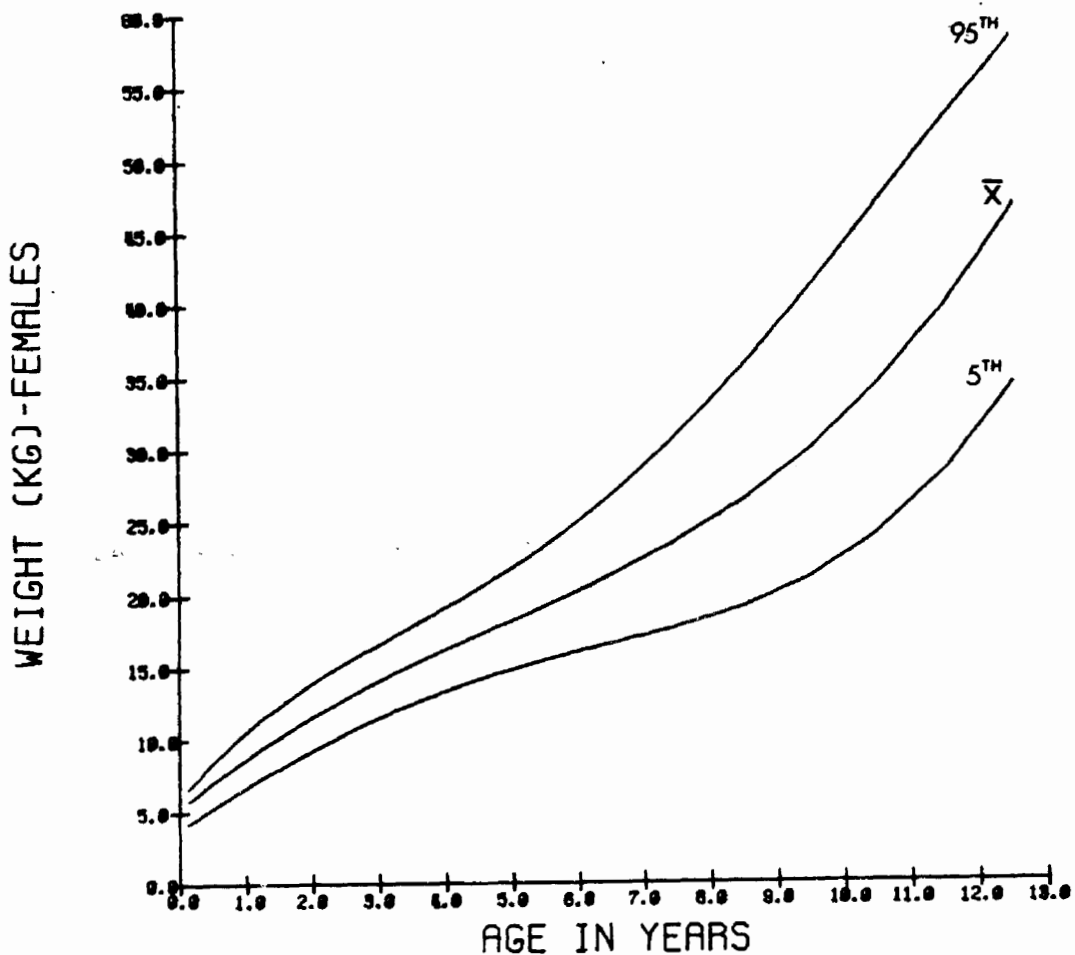

WEIGHT, IN KGS. - MALES

AGE (MO/YRS)	N	MEAN	S.D.	5%	50%	95%
0- 3	70	4.8	1.2	3.1	4.3	6.8
4- 6	40	7.4	0.9	5.9	7.3	8.9
7- 9	21	8.5	1.0	6.2	8.6	9.7
10- 12	19	9.5	0.8	7.8	9.4	11.1
13- 18	26	10.4	1.0	8.4	10.6	11.4
19- 24	33	12.2	1.2	10.3	12.0	14.1
25- 30	29	12.9	1.3	10.8	12.7	15.4
31- 36	30	14.2	1.5	12.2	13.5	16.8
37- 42	79	15.0	1.5	12.3	15.1	17.5
43- 48	72	15.8	1.8	12.9	15.6	19.0
49- 54	102	17.1	1.9	13.9	16.8	20.6
55- 60	85	18.3	2.1	15.3	18.0	22.4
61- 66	83	19.2	2.5	16.1	18.6	23.8
67- 72	79	20.8	3.0	15.6	21.7	24.7
73- 78	72	21.4	2.4	17.2	21.1	25.6
79- 84	74	23.2	3.1	18.8	22.8	28.9
85- 96	125	25.3	4.4	19.2	24.6	32.6
97-108	127	27.7	4.6	21.5	27.2	35.9
109-120	103	30.4	5.2	22.6	29.4	40.2
121-132	104	35.4	5.8	27.4	34.4	47.7
133-144	53	38.8	6.4	29.8	37.4	49.6
145-156	21	40.7	7.0	28.1	39.8	53.4

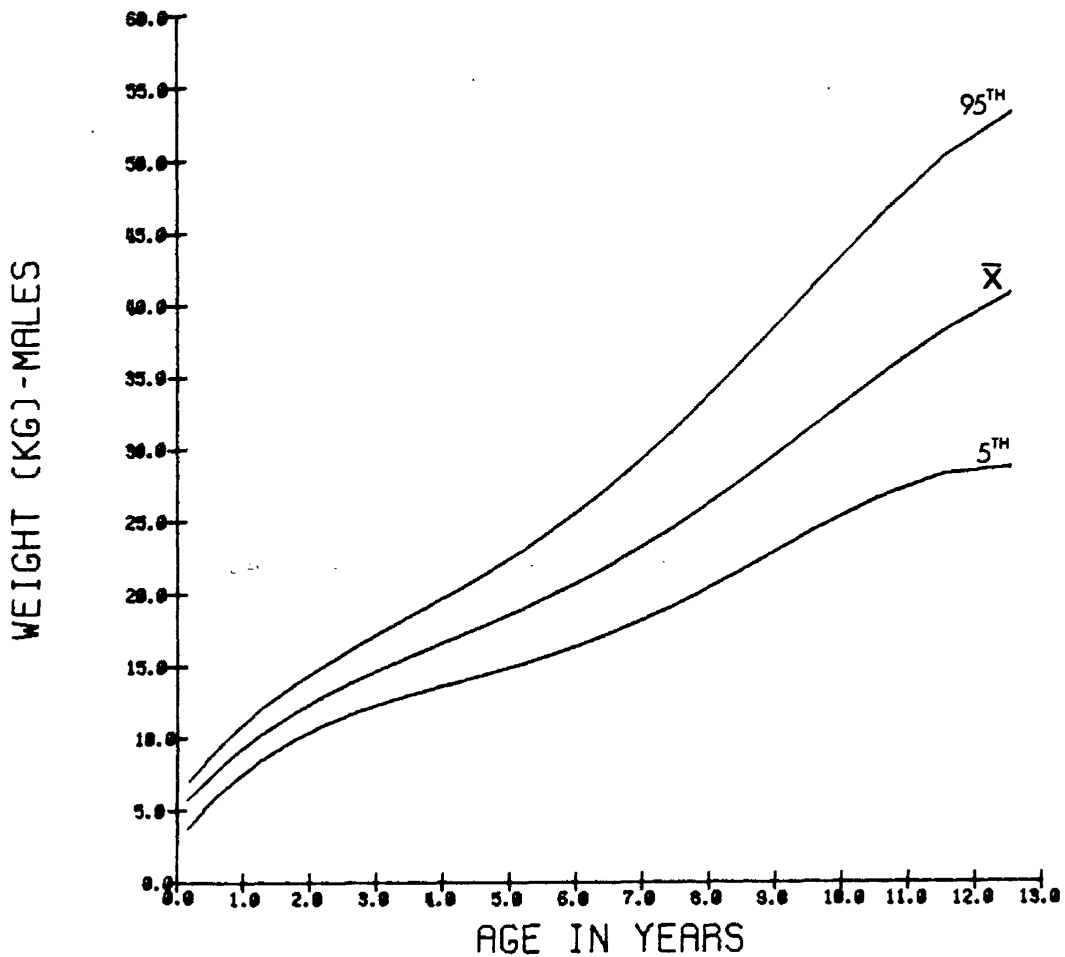

## CROWN-SOLE LENGTH

Device: Automated anthropometer. Measurements are recorded automatically by computer.

Description: INFANT: Infant lies on back with legs extended; the head is aligned in the Frankfort Plane relative to the extended torso. Measure the parallel distance from vertex to the heel of the right foot with an automated anthropometer. An assistant is required to assure that the infant is in the correct position.

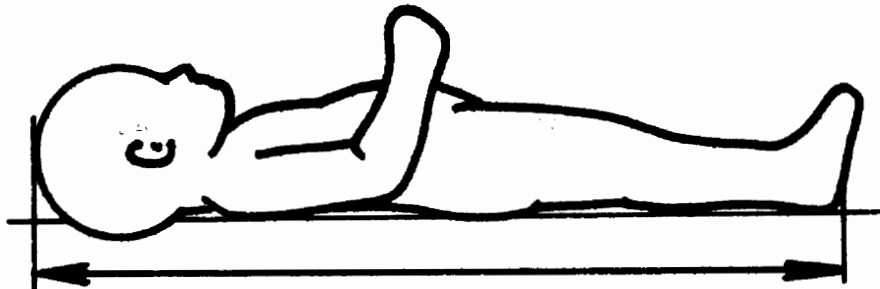
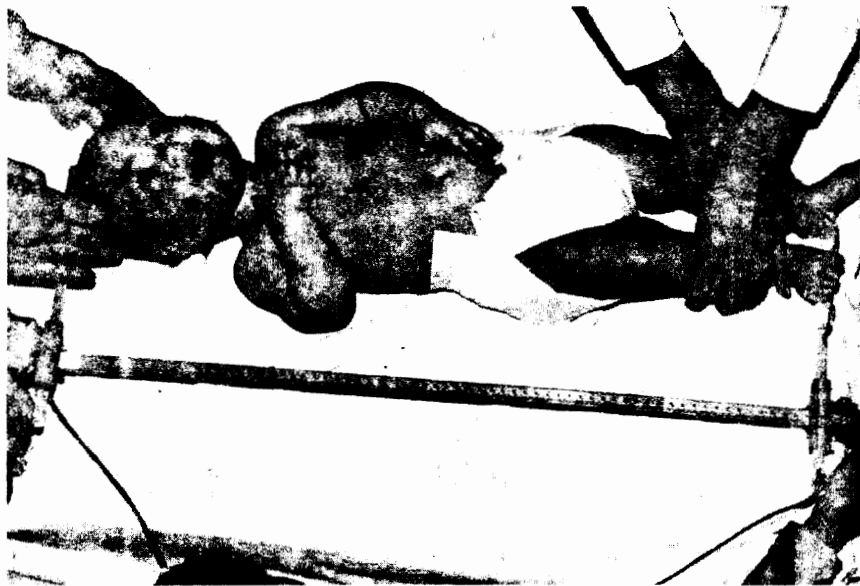



## STATURE

Device: Standard anthropometer. Measurements are read from the instrument and typed into the computer via keyboard.

Description: CHILD: Child stands erect with head in the Frankfort Plane, arms hanging at side. Measure the perpendicular distance from floor to vertex with a standard anthropometer.

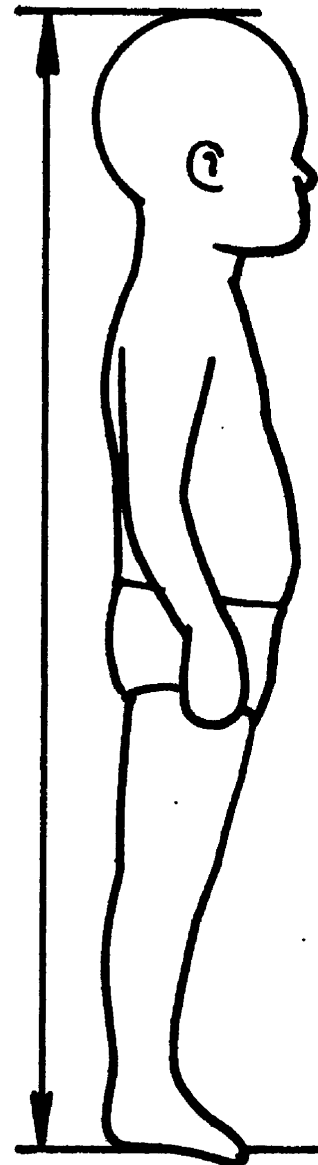
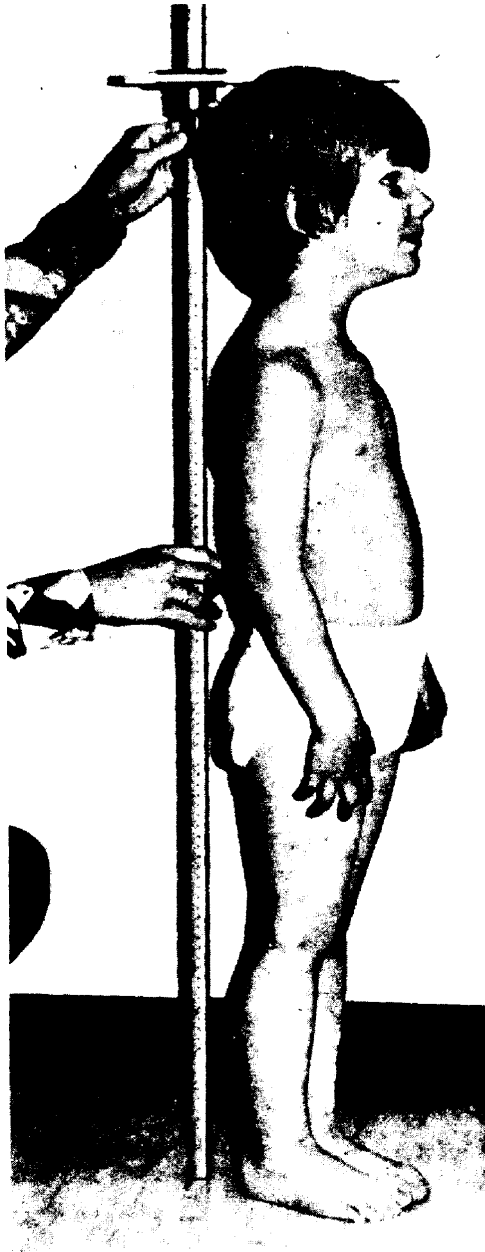

STATURE(CROWN-SOLE), IN CMS, - COMBINED SEXES

AGE(MO/YRS)	N	MEAN	S.D.	5%	50%	95%
0= 3	145	55.1	3.8	49.2	54.9	61.2
4= 6	99	64.4	3.0	59.8	63.7	70.4
7= 9	53	69.4	2.5	65.4	69.3	73.6
10= 12 1	47	72.9	3.1	68.6	72.5	78.5
13= 18	48	77.5	3.7	70.7	77.6	82.9
19= 24 2	58	84.7	3.4	79.6	84.1	90.4
25= 30	65	88.6	3.9	81.1	88.9	94.9
31= 36 3	102	93.1	4.2	86.9	93.2	99.4
37= 42	266	96.8	3.8	91.1	96.9	103.3
43= 48 4	290	99.7	4.1	92.8	99.4	106.5
49= 54	358	103.7	4.2	97.0	103.4	110.5
55= 60 5	326	107.0	4.8	98.9	107.0	115.0
61= 66	242	110.1	4.7	103.0	109.8	117.4
67= 72 6	174	113.3	4.9	104.4	113.6	120.5
73= 78	176	115.9	4.8	107.6	116.1	123.7
79= 84 7	170	119.6	4.9	110.4	119.8	127.1
85= 96 8	278	124.3	5.6	114.4	124.6	133.5
97=108 9	276	130.1	5.9	121.0	129.9	139.9
109=120 10	263	134.7	6.2	124.9	134.7	145.3
121=132 11	209	141.5	6.1	131.8	140.8	151.1
133=144 12	118	146.1	6.8	135.3	146.5	157.5
145=156 13	53	152.8	7.3	140.0	152.2	164.3

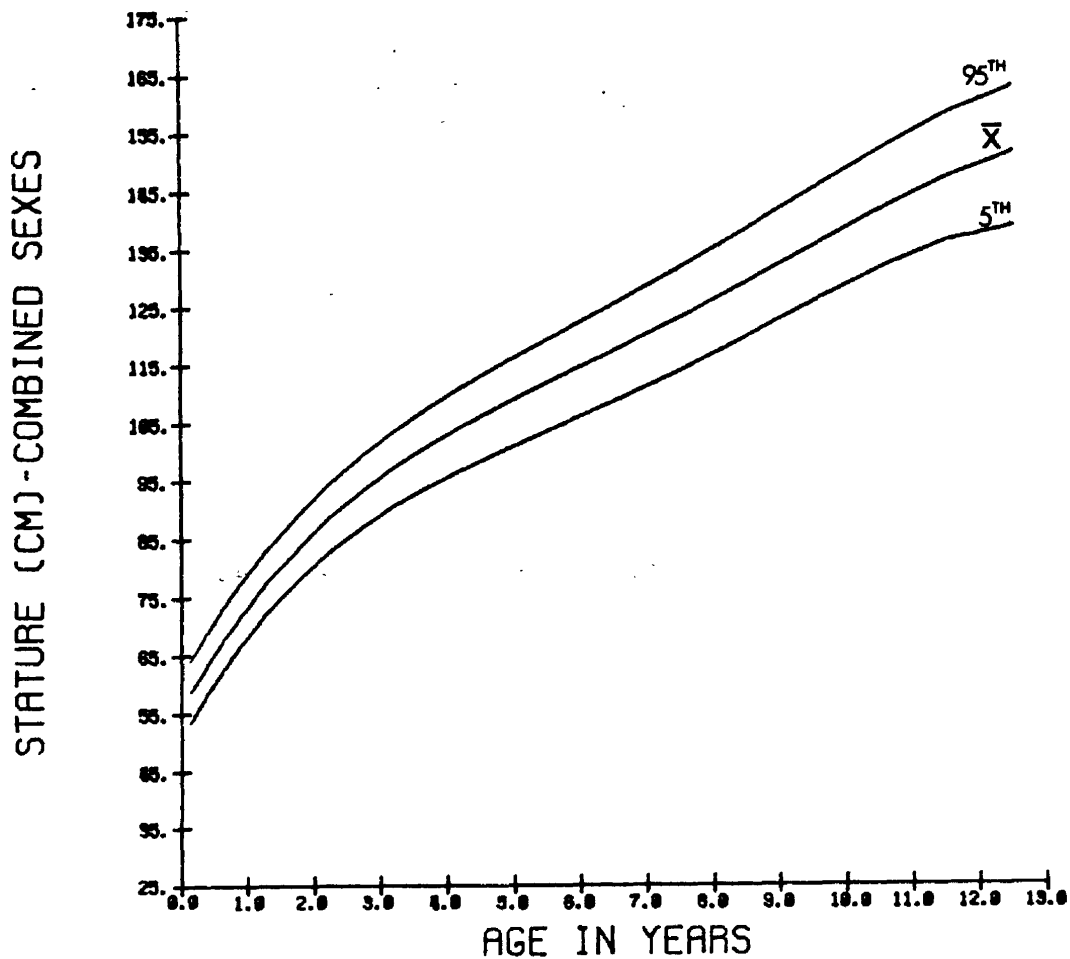

STATURE (CROWN=SOLE), IN CMS. - FEMALES

AGE (MO/YRS)	N	MEAN	S.D.	5%	50%	95%
0- 3	66	54.8	3.6	49.5	54.8	59.7
4- 6	53	63.3	2.5	58.5	63.2	67.3
7- 9	29	68.6	2.3	64.1	68.8	72.2
10- 12	1	25	72.4	2.9	67.5	72.7
13- 18	23	76.0	3.6	68.8	75.0	81.5
19- 24	2	27	84.0	3.4	77.1	83.7
25- 30	30	89.0	3.9	81.8	88.4	95.0
31- 36	3	54	92.9	4.4	86.6	92.0
37- 42	137	96.3	4.0	89.6	96.7	102.3
43- 48	4	170	99.5	4.3	91.8	99.3
49- 54	186	103.1	4.0	95.5	102.8	109.7
55- 60	5	174	106.5	4.7	98.7	106.9
61- 66	118	109.6	4.5	101.9	109.7	116.6
67- 72	6	82	112.8	5.0	104.2	113.1
73- 78	98	115.5	5.2	105.5	115.5	123.1
79- 84	7	94	118.8	5.0	109.9	119.5
85- 96	8	144	123.4	5.3	113.8	123.7
97-108	9	143	130.2	5.9	120.9	129.8
109-120	10	155	134.4	6.1	126.0	133.7
121-132	11	108	141.1	6.8	130.5	140.5
133-144	12	63	145.5	6.5	135.3	146.2
145-156	13	32	155.1	6.2	144.0	154.7

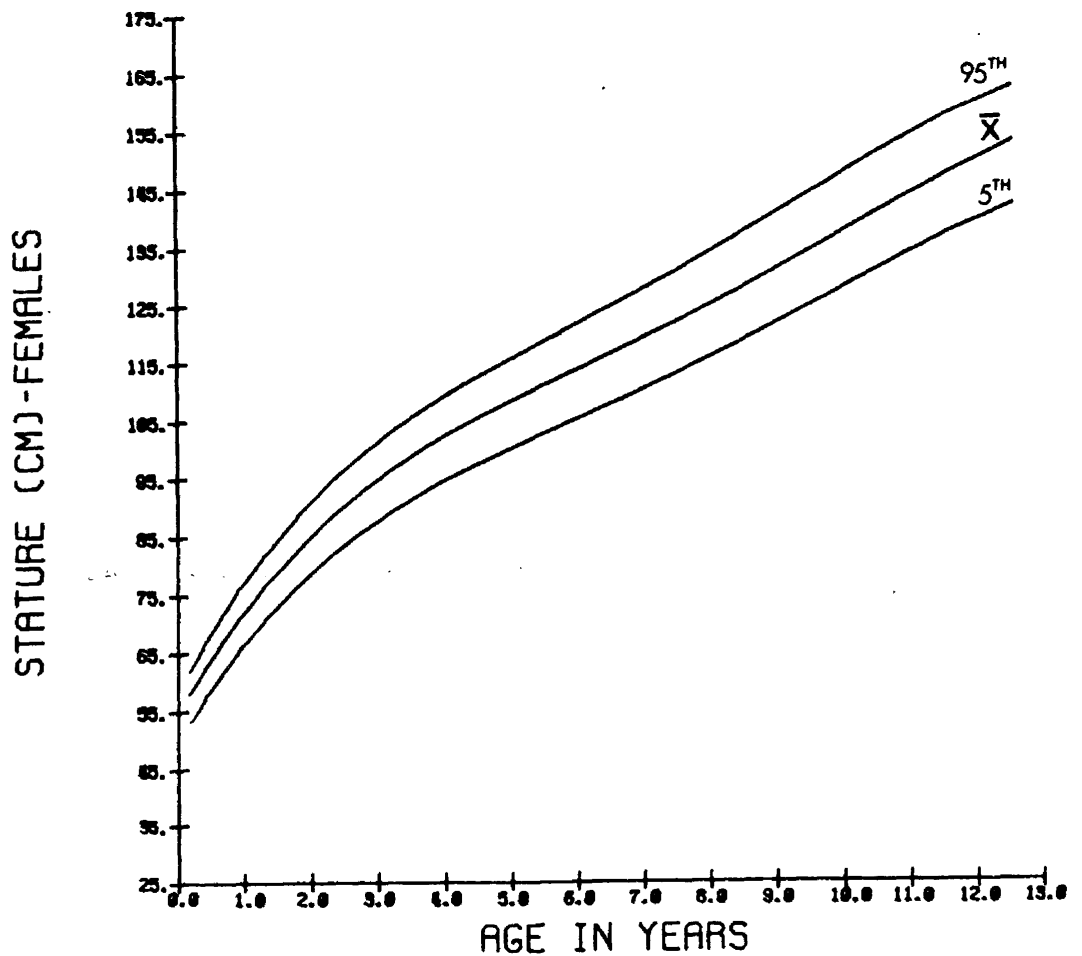

STATURE (CROWN-SOLE), IN CMS. - MALES

AGE (MO/YRS)	N	MEAN	S.D.	5%	50%	95%	
0- 3	79	55.4	4.0	49.0	55.1	61.9	
4- 6	46	65.6	3.1	60.1	65.3	70.8	
7- 9	24	70.4	2.4	65.7	70.6	73.6	
10- 12	1	22	73.5	3.2	68.6	72.4	79.8
13- 18	25	78.9	3.3	71.5	79.3	83.7	
19- 24	2	31	85.3	3.4	80.4	84.4	90.9
25- 30	35	88.4	4.0	80.7	88.9	93.8	
31- 36	3	48	93.4	3.9	86.2	93.6	98.8
37- 42	129	97.3	3.5	92.0	96.9	103.4	
43- 48	4	120	99.9	3.8	93.4	99.5	106.2
49- 54	172	104.3	4.3	98.6	103.9	111.5	
55- 60	5	152	107.6	5.0	98.9	107.2	115.9
61- 66	124	110.6	4.8	103.4	110.2	117.7	
67- 72	6	92	113.7	4.8	105.4	114.3	120.3
73- 78	78	116.4	4.2	108.8	116.5	123.8	
79- 84	7	76	120.5	4.7	112.7	119.9	129.1
85- 96	8	134	125.3	5.8	116.0	125.0	134.1
97-108	9	133	130.0	5.8	120.7	130.0	138.9
109-120	10	108	135.1	6.3	123.4	135.3	146.0
121-132	11	101	141.9	5.3	133.0	141.0	150.3
133-144	12	55	146.8	7.1	135.3	146.9	160.7
145-156	13	21	149.5	7.8	137.9	148.3	160.3

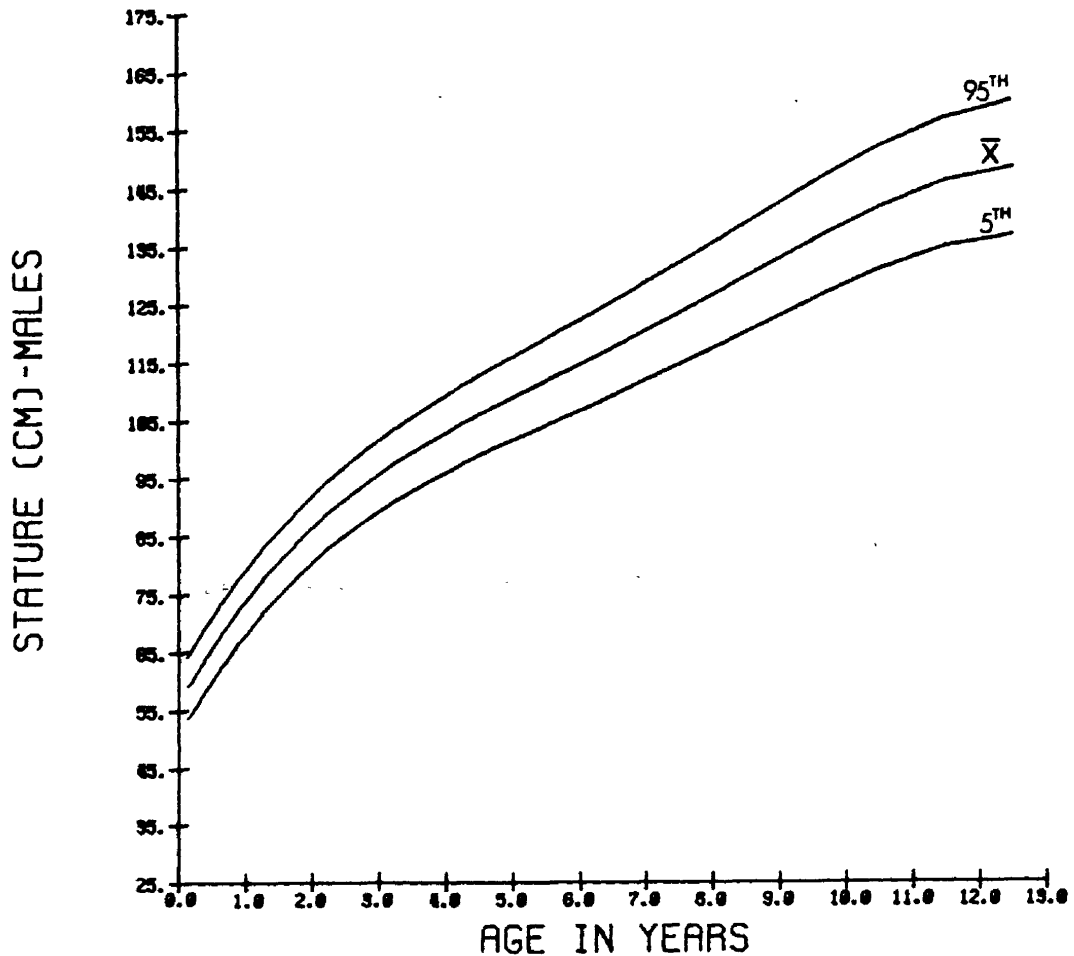

## CROWN-RUMP LENGTH

Device: Automated anthropometer equipped with pressure transducer in paddle blade. Measurements are recorded automatically by computer at fixed pressure values.

Description: INFANT: Infant lies on back with leg flexed 90° to torso so that rotation of the pelvis is minimal. Measure the parallel distance from vertex to the surface of the right buttock with an automated anthropometer. Pressure is momentarily applied with the pressure transducer paddle-blade on the interior surface of the buttock. An assistant is required to assure that the infant is in the correct position.

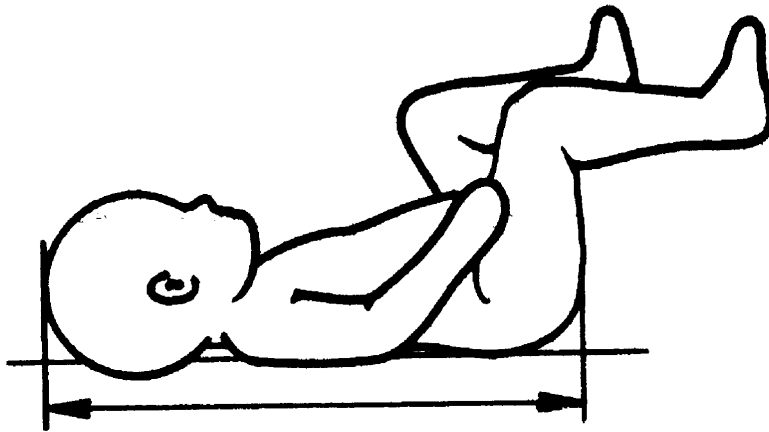
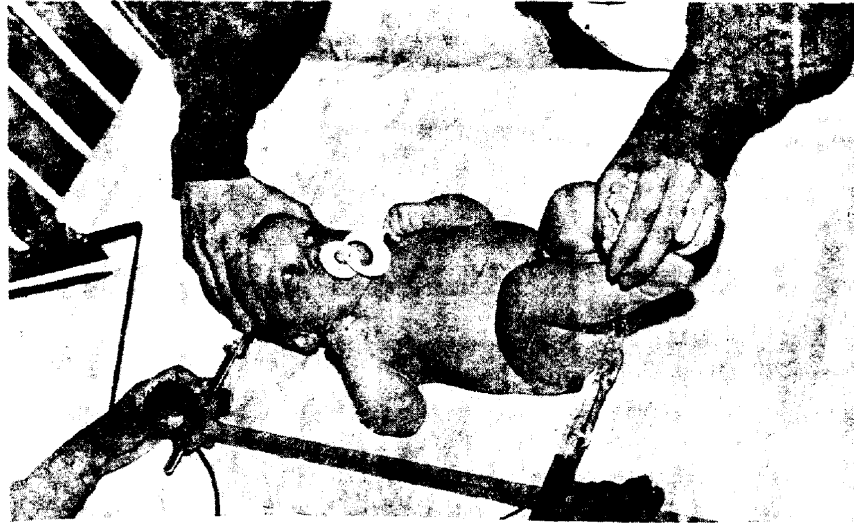

## SITTING HEIGHT

Device: Standard anthropometer. Measurements are read from the instrument and typed into the computer via keyboard.

Description: CHILD: Child sits erect with head in the Frankfort Plane, arms hanging at side, hands resting on thigh. Measure the perpendicular distance from the seat to vertex with a standard anthropometer.

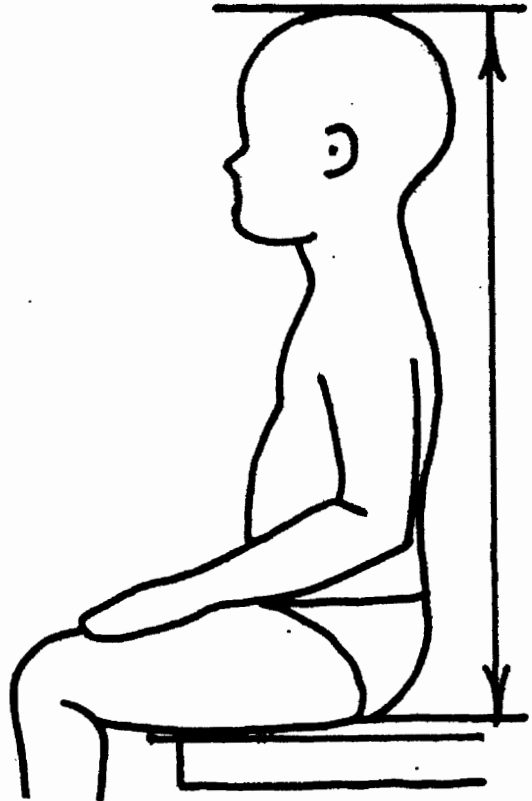

SITTING HEIGHT(CROWN-RUMP), IN CMS. - COMBINED SEXES

AGE(MO/YRS)	N	MEAN	S.D.	5%	50%	95%
0= 3	135	36.8	2.6	32.6	36.5	40.8
4= 6	93	42.3	2.1	38.9	42.3	45.8
7= 9	45	44.8	1.9	41.5	44.7	47.8
10= 12 1	34	46.7	2.2	43.1	46.2	49.9
13= 18	38	48.8	2.4	43.6	48.9	52.5
19= 24 2	52	51.5	2.2	48.2	51.0	55.2
25= 30	61	52.0	2.4	47.7	51.6	55.8
31= 36 3	102	53.5	2.4	49.3	53.5	57.4
37= 42	263	55.2	2.6	51.3	54.9	58.9
43= 48 4	288	56.4	2.5	52.1	56.4	60.6
49= 54	360	57.7	2.5	53.5	57.8	62.1
55= 60 5	325	59.3	2.8	54.3	59.4	63.9
61= 66	243	60.7	2.8	55.7	60.7	65.2
67= 72 6	173	61.9	2.7	56.8	61.8	65.7
73= 78	176	62.8	2.7	58.0	62.9	66.9
79= 84 7	171	64.4	2.8	59.7	64.5	69.2
85= 96 8	276	66.4	2.9	61.3	66.3	71.4
97=108 9	276	68.8	2.9	64.8	68.7	73.6
109=120 10	261	70.7	3.3	65.5	70.5	75.9
121=132 11	207	73.4	3.1	68.7	73.3	78.2
133=144 12	117	75.4	3.5	69.6	75.3	82.0
145=156 13	53	79.2	4.0	71.8	78.7	86.1

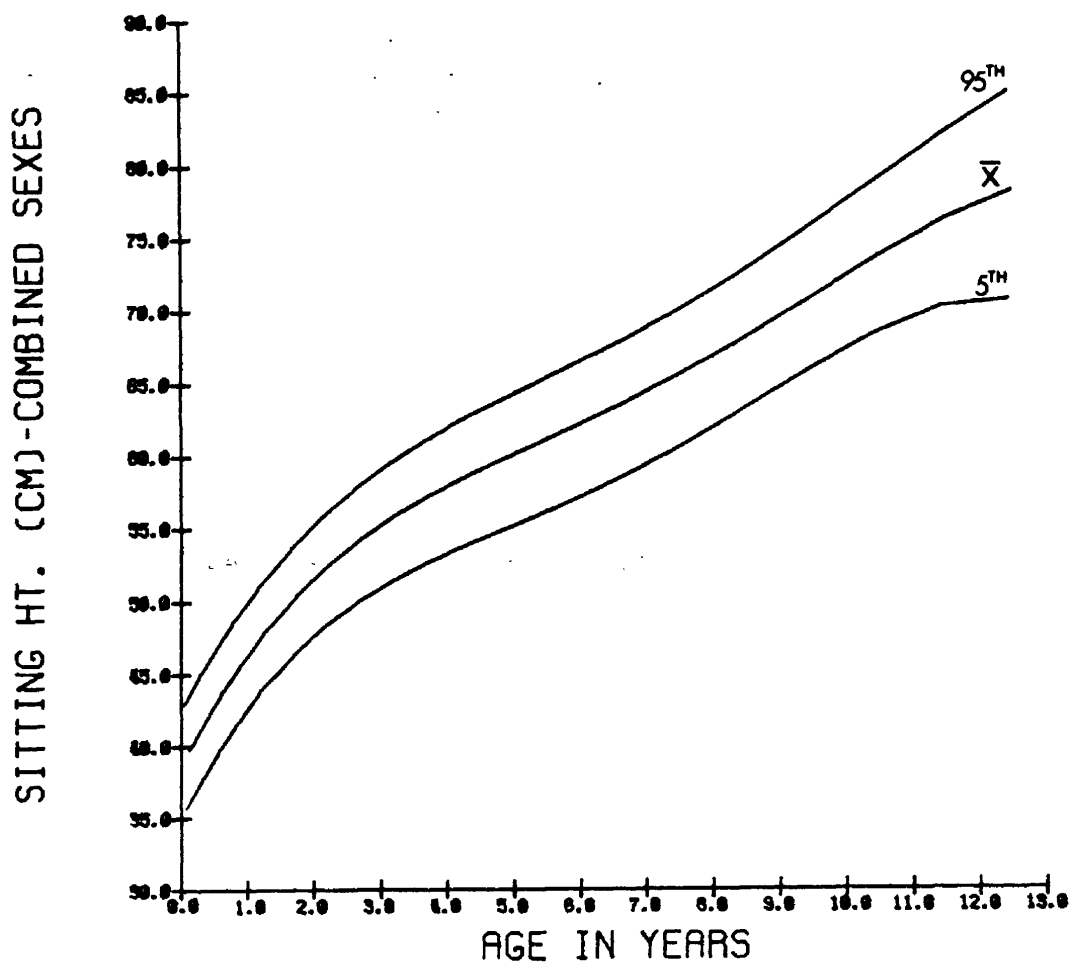

SITTING HEIGHT (CROWN-RUMP), IN CMS. - FEMALES

AGE (MO/YRS)	N	MEAN	S.D.	5%	50%	95%
0- 3	60	36.5	2.5	32.4	36.4	40.2
4- 6	50	41.7	1.8	38.7	41.9	44.3
7- 9	24	44.1	1.7	41.3	43.8	46.5
10- 12	1	18	46.3	2.3	43.0	45.6
13- 18	17	47.7	2.5	43.5	47.5	52.4
19- 24	2	25	50.7	1.9	48.1	50.3
25- 30	30	52.2	2.4	47.6	51.6	55.9
31- 36	3	55	52.9	2.5	48.8	53.2
37- 42	135	55.0	2.2	51.3	54.8	58.4
43- 48	169	56.0	2.5	51.6	55.9	60.5
49- 54	186	57.2	2.5	53.1	57.2	61.2
55- 60	175	59.0	2.8	54.0	58.9	63.6
61- 66	119	60.1	2.9	55.0	60.4	64.7
67- 72	82	61.3	2.5	56.9	61.2	65.0
73- 78	98	62.4	2.6	58.0	62.5	66.5
79- 84	94	63.8	2.8	58.9	64.3	67.6
85- 96	142	65.7	2.8	60.7	65.8	70.4
97-108	143	68.5	2.8	63.5	68.2	73.3
109-120	154	70.6	3.2	65.7	70.3	76.1
121-132	107	73.3	3.4	68.2	73.2	78.3
133-144	63	75.4	3.7	69.5	75.3	81.9
145-156	32	80.8	3.5	75.3	80.4	86.2

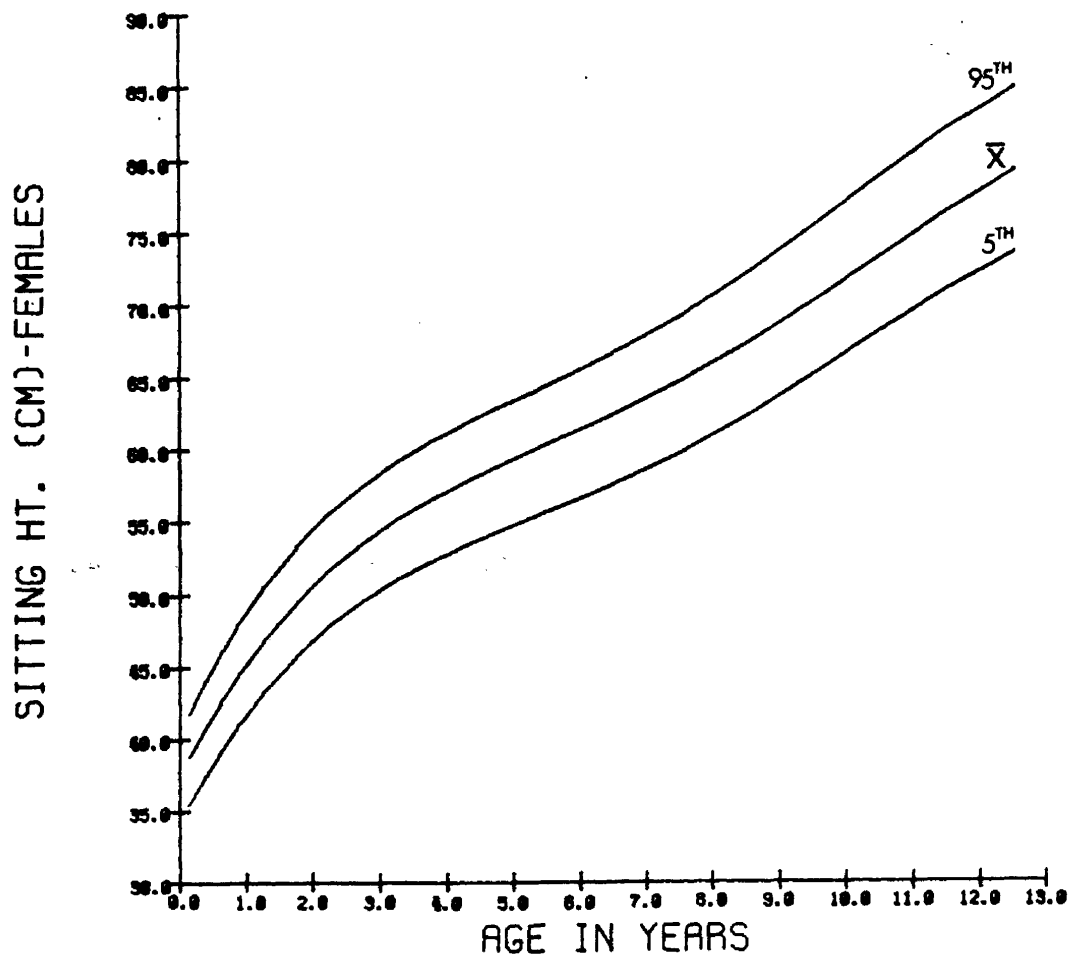



SITTING HEIGHT(CROWN=RUMP), IN CMS. - MALES

AGE(MO/YRS)	N	MEAN	S.D.	5%	50%	95%	
0= 3	75	37.0	2.7	32.6	36.9	41.4	
4= 6	43	43.1	2.2	39.0	42.8	46.7	
7= 9	21	45.6	1.8	42.3	46.1	47.8	
10= 12	1	16	47.2	1.9	44.7	46.3	50.3
13= 18	21	49.6	2.1	44.8	49.7	53.3	
19= 24	2	27	52.2	2.2	48.3	52.2	55.7
25= 30	31	51.8	2.4	47.3	51.8	55.5	
31= 36	3	47	54.1	2.1	50.2	54.1	57.6
37= 42	128	55.3	2.8	51.2	55.0	59.1	
43= 48	4	119	57.0	2.4	53.3	56.8	60.8
49= 54	174	58.3	2.5	53.8	58.3	62.4	
55= 60	5	150	59.7	2.7	54.9	59.6	64.1
61= 66	124	61.3	2.6	57.4	61.1	65.4	
67= 72	6	91	62.4	2.7	56.8	62.8	65.8
73= 78	78	63.3	2.7	57.3	63.4	67.0	
79= 84	7	77	65.2	2.7	60.8	65.0	69.8
85= 96	8	134	67.1	2.9	61.8	66.9	71.9
97=108	9	133	69.1	3.0	64.4	68.9	73.7
109=120	10	107	70.7	3.4	64.4	70.8	75.9
121=132	11	100	73.5	2.7	69.4	73.3	77.9
133=144	12	54	75.4	3.3	70.1	75.1	81.7
145=156	13	21	76.8	3.7	71.5	76.9	82.4

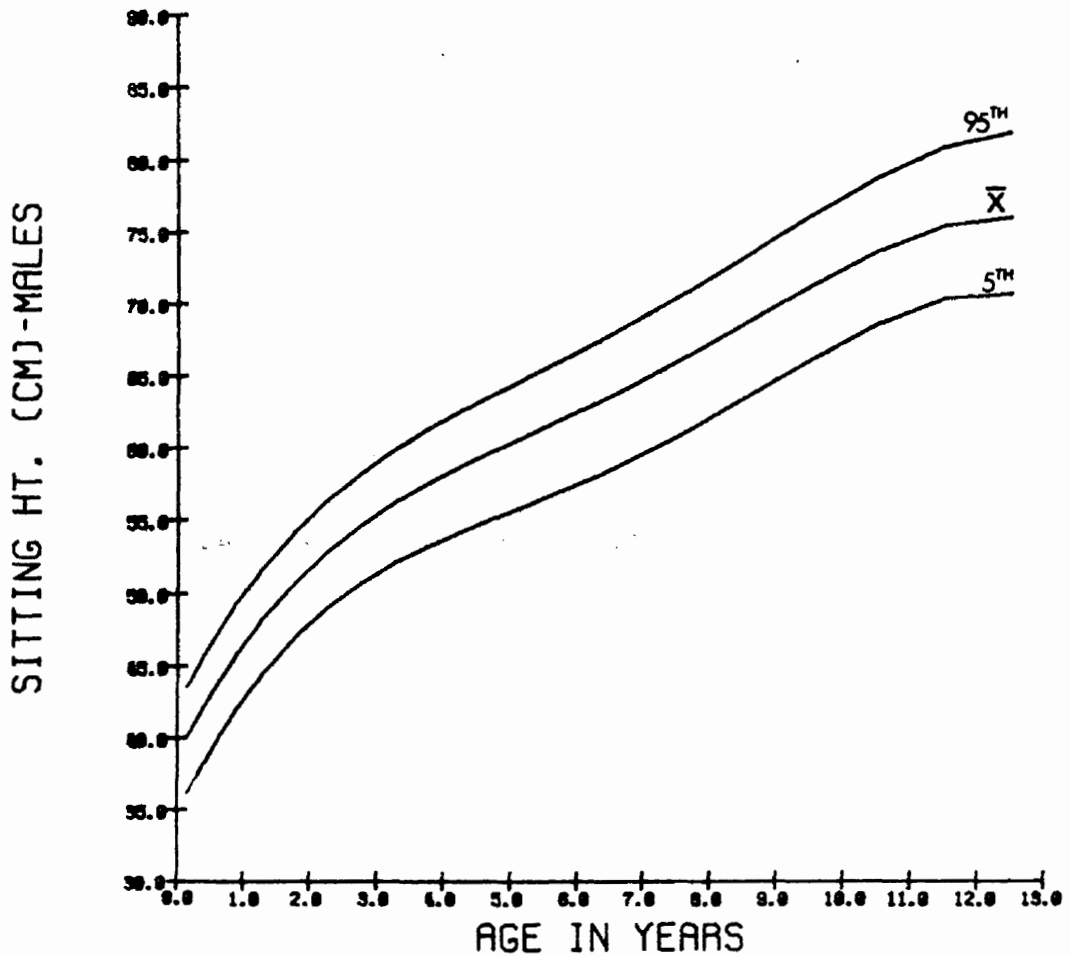

## SITTING MID-SHOULDER HEIGHT

Device: Standard anthropometer. Measurements are read from the instrument and typed into the computer via keyboard.

Description: CHILD: Child sits erect with head in the Frankfort Plane, arms hanging at side, with hands resting on thighs. Measure the perpendicular distance from the seat surface to a point on the superior surface of the right shoulder midway between the neck-shoulder junction and the lateral surface of the shoulder with a standard anthropometer.

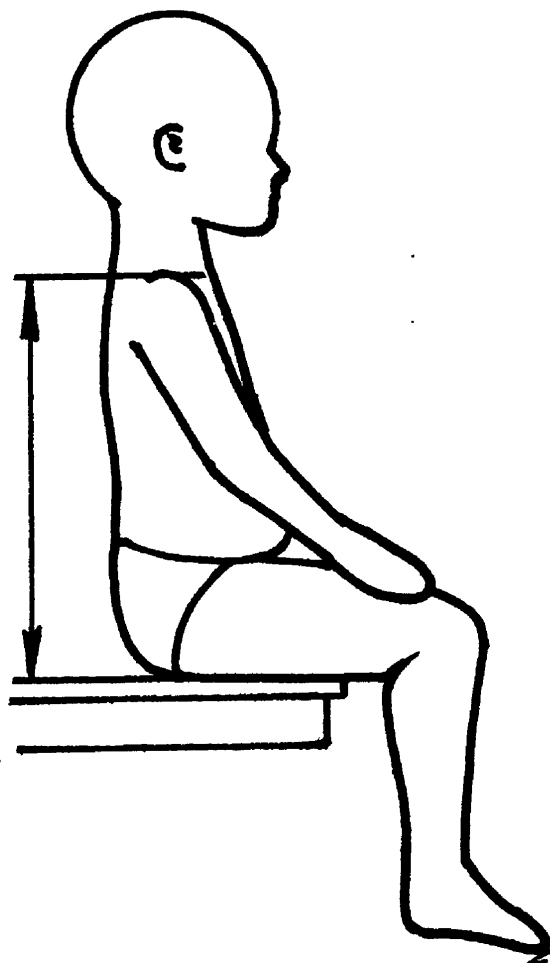

SITTING MID-SHOULDER HEIGHT, IN CMS. - COMBINED SEXES

AGE(MO/YRS)	N	MEAN	S.D.	5%	50%	95%	
25= 30	53	31.5	1.9	28.4	31.3	34.7	
31= 36	3	98	32.6	1.9	29.4	32.4	35.7
37= 42	265	34.1	1.9	30.6	33.9	37.4	
43= 48	4	288	34.8	2.2	31.3	34.8	37.9
49= 54	356	35.8	2.2	32.1	35.7	39.4	
55= 60	5	326	36.9	2.3	32.8	36.9	40.9
61= 66	243	38.1	2.3	34.2	37.9	42.2	
67= 72	6	173	38.9	2.3	34.8	38.7	43.0
73= 78	177	39.7	2.5	35.4	39.4	44.0	
79= 84	7	174	40.9	2.4	37.2	40.7	44.7
85= 96	8	276	42.3	2.4	38.1	42.2	46.2
97=108	9	276	44.2	2.4	40.3	43.9	48.3
109=120	10	260	45.7	2.6	41.5	45.4	49.9
121=132	11	206	47.8	2.4	43.8	47.7	51.8
133=144	12	117	49.5	2.7	44.6	49.3	54.3
145=156	13	53	52.2	3.0	46.0	51.7	56.7

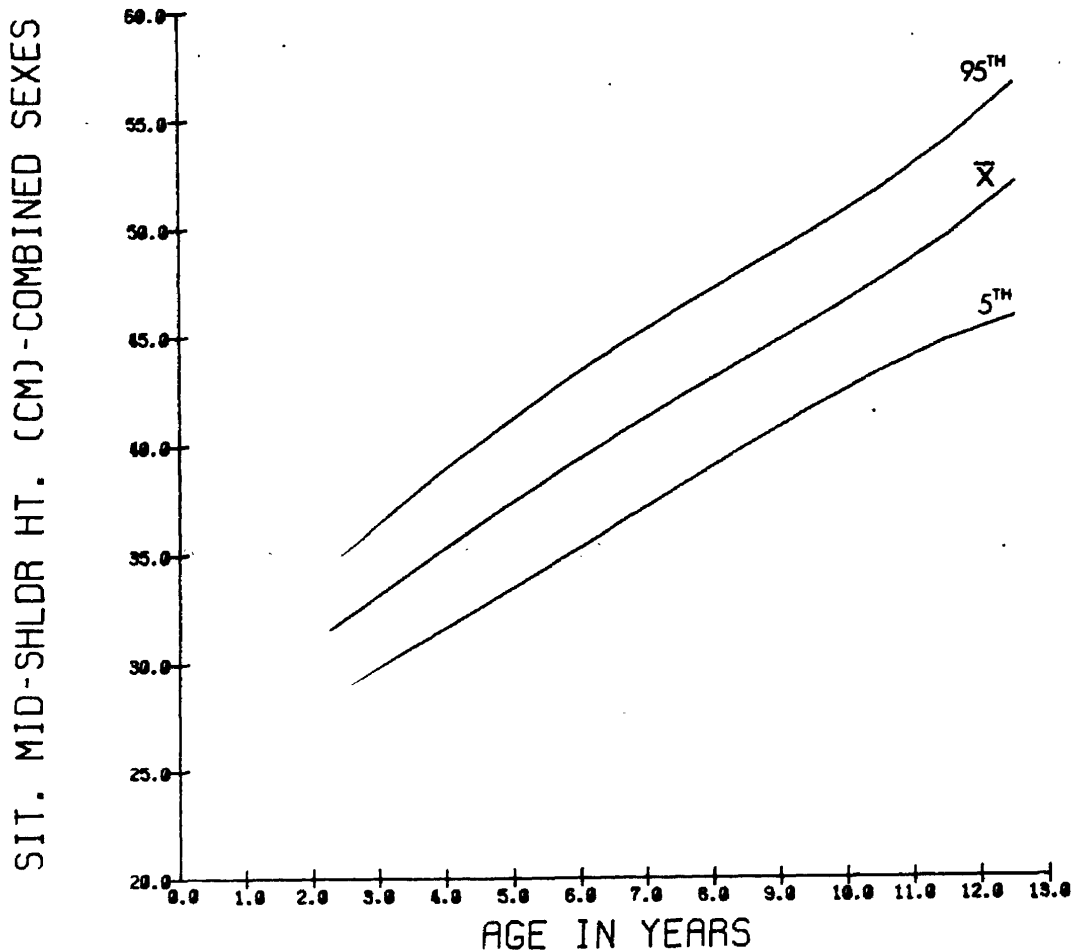

SITTING MID-SHOULDER HEIGHT, IN CMS, - FEMALES

AGE (MO/YRS)	N	MEAN	S.D.	5%	50%	95%
25= 30	24	31.9	2.2	28.1	31.3	35.5
31= 36	3	32.4	2.1	28.5	32.3	35.7
37= 42	137	34.1	1.9	30.8	34.0	37.2
43= 48	4	34.5	2.1	31.0	34.5	37.8
49= 54	186	35.5	2.2	31.9	35.4	39.4
55= 60	5	36.7	2.4	32.5	36.5	40.9
61= 66	121	37.8	2.3	34.1	37.7	41.9
67= 72	82	38.5	2.3	34.6	38.3	42.0
73= 78	99	39.4	2.4	35.6	38.8	43.7
79= 84	7	40.4	2.4	36.5	40.2	44.2
85= 96	8	41.8	2.4	37.5	42.0	45.3
97=108	9	44.0	2.3	40.2	43.9	48.2
109=120	10	45.6	2.6	41.4	45.6	49.9
121=132	11	47.7	2.6	43.7	47.5	52.0
133=144	12	49.5	2.8	44.6	49.6	53.4
145=156	13	53.6	2.6	49.1	53.6	57.1

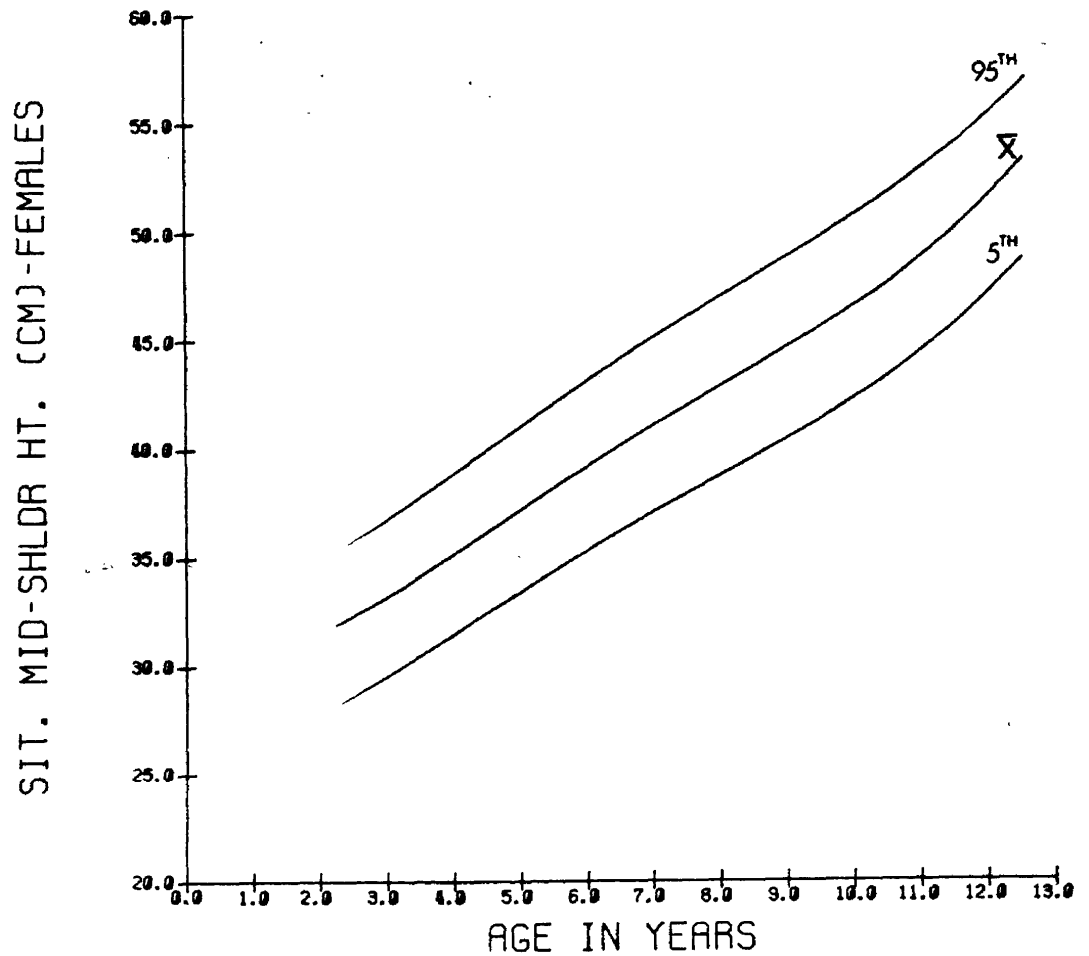

SITTING MID-SHOULDER HEIGHT, IN CMS. - MALES

AGE(MO/YRS)	N	MEAN	S.D.	5X	50X	95X
0- 3	0	0.0	0.0	0.0	0.0	0.0
4- 6	0	0.0	0.0	0.0	0.0	0.0
7- 9	0	0.0	0.0	0.0	0.0	0.0
10- 12	1	0.0	0.0	0.0	0.0	0.0
13- 18	0	0.0	0.0	0.0	0.0	0.0
19- 24	0	0.0	0.0	0.0	0.0	0.0
25- 30	29	31.3	1.7	28.2	31.2	33.7
31- 36	45	32.7	1.6	30.2	32.5	35.5
37- 42	128	34.0	2.0	30.4	33.7	37.6
43- 48	119	35.2	2.2	31.3	35.4	38.5
49- 54	170	36.2	2.1	32.5	36.2	39.5
55- 60	151	37.1	2.2	33.4	37.2	40.8
61- 66	122	38.4	2.3	34.4	38.3	42.3
67- 72	91	39.2	2.3	34.9	39.2	43.3
73- 78	78	40.0	2.6	35.2	40.1	44.5
79- 84	79	41.6	2.3	38.2	41.3	45.9
85- 96	133	42.8	2.3	39.0	42.8	47.3
97-108	133	44.3	2.4	40.0	43.9	48.4
109-120	107	45.7	2.6	41.4	45.3	49.7
121-132	101	47.0	2.2	43.9	47.8	51.4
133-144	54	49.4	2.6	45.1	49.2	54.6
145-156	21	50.2	2.6	45.6	50.7	53.5

SIT. MID-SHLDR HT. (CM)-MALES

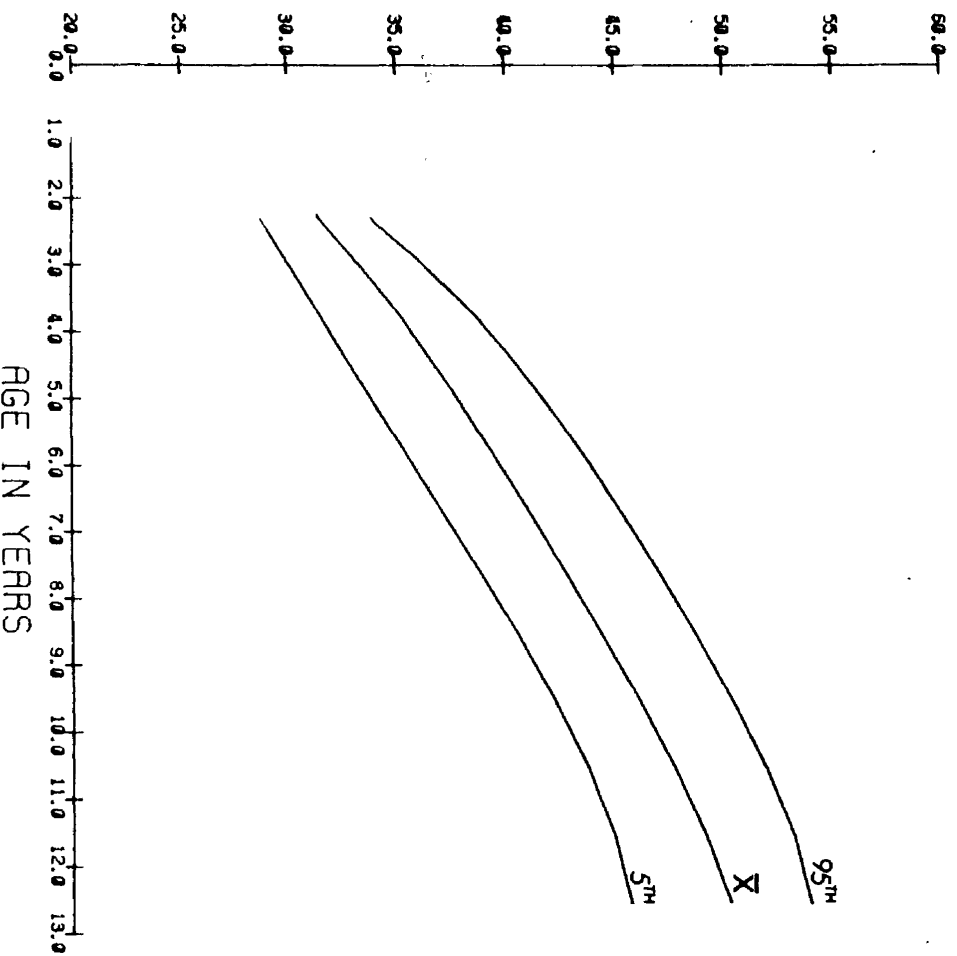

## CROTCH HEIGHT

Device: Standard anthropometer. Measurements are read from the instrument and typed into the computer via keyboard.

Description: CHILD: Child stands erect facing the anthropometrist with feet spread apart slightly. The blade is placed against the medial-superior surface of the right thigh and the subject is asked to bring feet together. Measure the perpendicular distance from the floor to the point in the crotch where firm contact between anthropometer blade and flesh is made with a standard anthropometer.

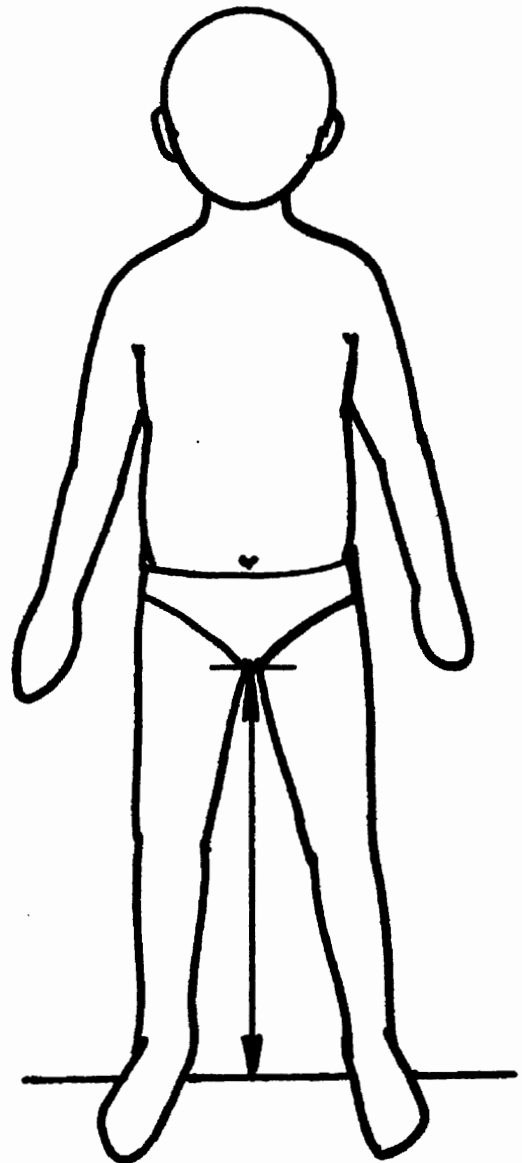
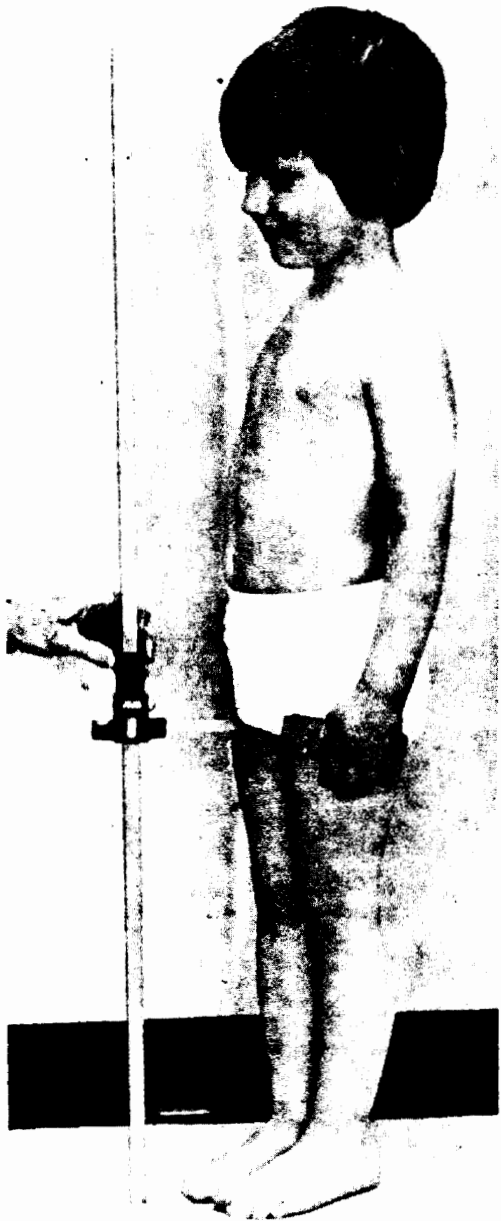

CROTCH HEIGHT, IN CMS, - COMBINED SEXES

AGE (MO/YRS)	N	MEAN	S.D.	5%	50%	95%
25= 30	20	35.1	3.5	29.1	34.1	44.0
31= 36	3	37.7	2.4	34.0	37.3	42.0
37= 42	118	40.2	2.2	36.1	40.0	44.1
43= 48	4	42.2	2.6	37.8	42.2	46.6
49= 54	177	44.8	2.9	40.2	44.7	49.6
55= 60	5	47.0	2.9	41.8	46.9	51.9
61= 66	156	48.9	3.2	43.5	48.7	54.3
67= 72	6	50.6	3.1	45.7	50.8	55.4
73= 78	144	52.3	3.1	46.7	52.4	57.7
79= 84	7	54.8	3.1	49.3	54.6	60.3
85= 96	8	57.6	3.5	51.4	57.5	63.4
97=108	9	61.3	3.6	55.3	61.2	67.2
109=120	10	64.2	3.6	58.2	63.8	70.3
121=132	11	68.3	3.6	62.4	68.4	73.9
133=144	12	70.8	4.1	64.0	70.8	78.2
145=156	13	74.6	4.5	66.2	74.5	80.6

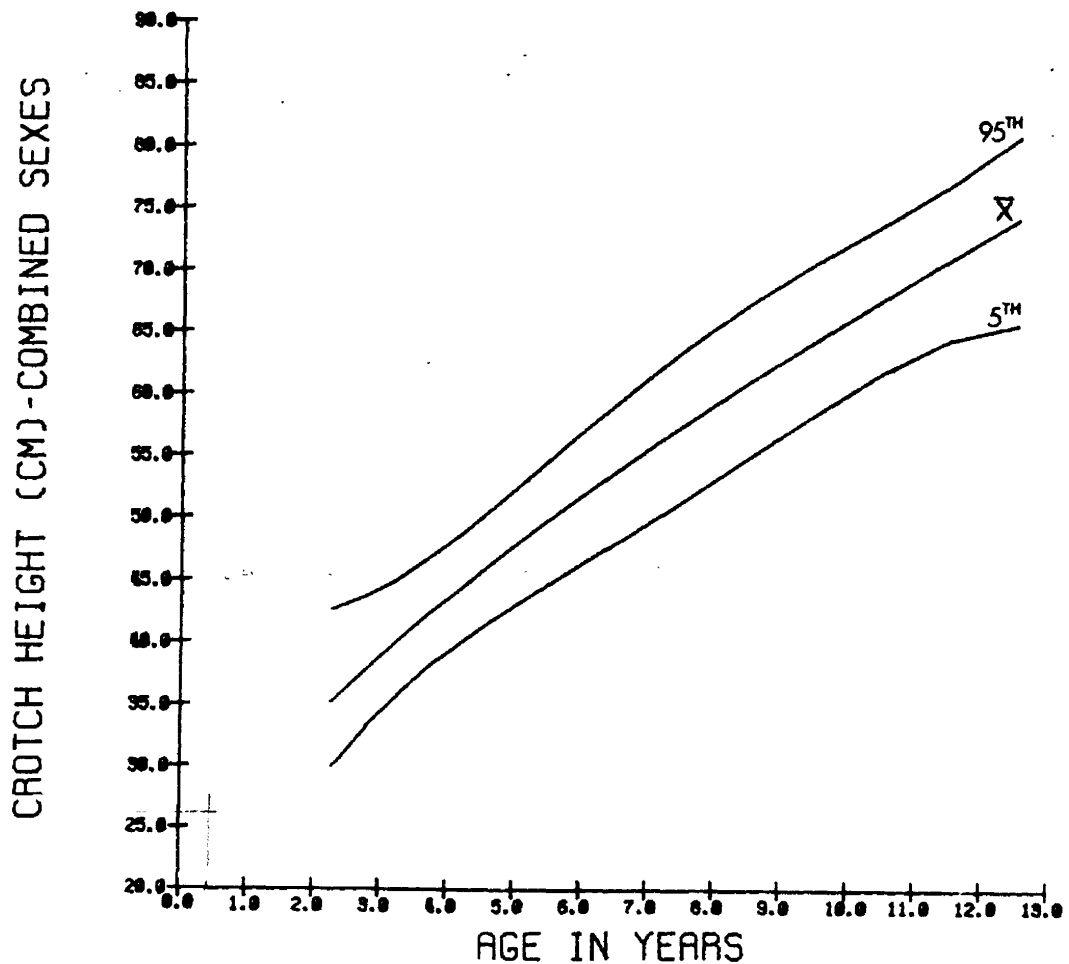

CROTCH HEIGHT, IN CMS. - FEMALES

AGE(MO/YRS)	N	MEAN	S.D.	5%	50%	95%
25= 30	16	35.6	3.7	29.1	35.6	44.0
31= 36 3	17	37.8	2.7	33.3	37.2	42.5
37= 42	55	40.3	2.1	36.6	40.0	44.1
43= 48 4	76	42.6	2.7	38.2	42.7	47.4
49= 54	94	45.0	2.8	40.2	45.2	49.6
55= 60 5	96	47.1	2.9	41.8	46.9	51.9
61= 66	81	49.2	3.1	44.0	48.8	54.3
67= 72 6	68	50.7	3.1	45.2	51.2	55.4
73= 78	86	52.7	3.2	47.1	52.5	58.1
79= 84 7	81	54.7	3.1	49.0	54.6	60.3
85= 96 8	125	57.4	3.4	51.8	57.5	62.8
97=108 9	131	61.8	3.6	55.9	61.6	67.5
109=120 10	132	64.3	3.5	58.9	63.6	70.3
121=132 11	95	68.3	3.9	62.3	68.3	74.8
133=144 12	54	70.9	4.2	63.2	71.0	77.7
145=156 13	30	75.9	3.8	68.3	76.1	80.9

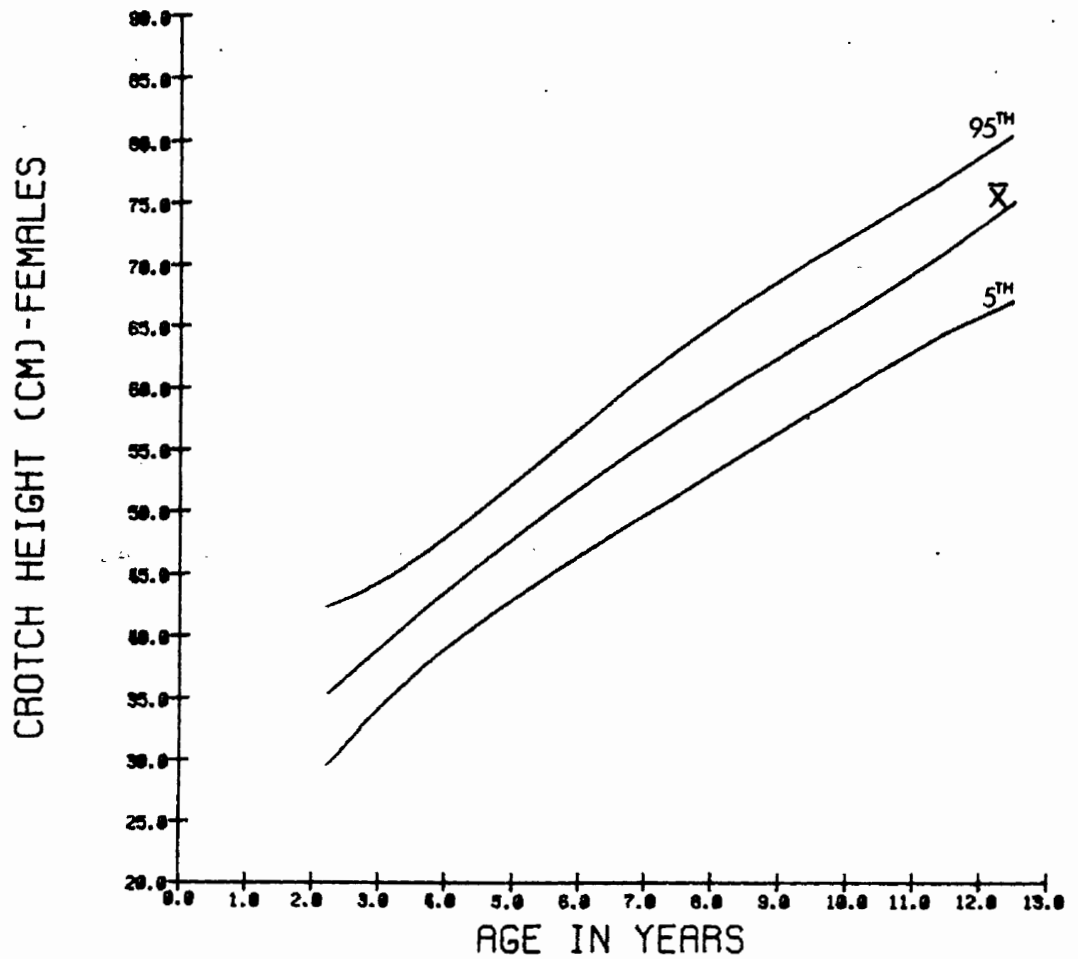



CROTCH HEIGHT, IN CMS, - MALES

AGE(MO/YRS)	N	MEAN	S.D.	5%	50%	95%
25= 30	4	32.9	1.2	31.5	32.5	34.1
31= 36	3	37.5	2.2	34.4	37.1	41.6
37= 42	63	40.1	2.3	35.3	40.0	43.1
43= 48	4	41.7	2.4	37.4	41.5	45.8
49= 54	83	44.5	3.0	39.9	44.4	49.2
55= 60	5	46.9	2.9	41.8	46.9	51.4
61= 66	75	48.6	3.4	43.2	48.5	53.1
67= 72	6	50.5	3.0	45.4	50.5	55.1
73= 78	58	51.8	2.9	45.7	52.1	55.6
79= 84	7	54.9	3.1	49.3	54.5	59.9
85= 96	8	57.8	3.7	51.1	57.7	63.7
97=108	9	60.6	3.5	54.2	60.5	65.6
109=120	10	63.9	3.9	57.2	64.2	70.0
121=132	11	68.3	3.2	62.5	68.5	73.4
133=144	12	70.6	4.1	63.8	70.6	77.9
145=156	13	69.9	3.9	63.5	69.7	74.5

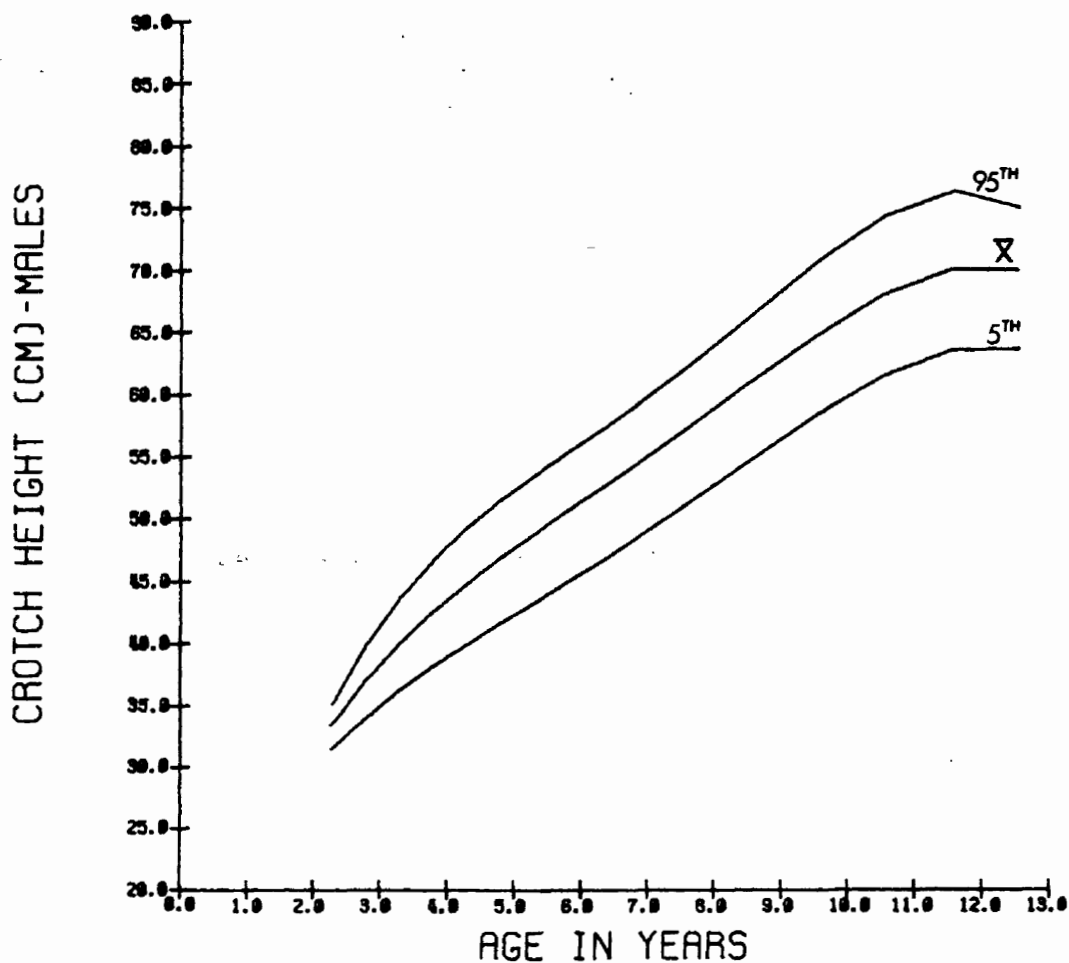

## BUTTOCK-KNEE (RUMP-KNEE) LENGTH

Device: Automated anthropometer equipped with pressure transducer in paddle blade. Measurements are recorded automatically by computer at fixed pressure values.

Description: INFANT: Infant lies on left side with 90° right hip flexion and 90° right knee flexion. Measure the parallel distance from posterior surface of the right buttock to the anterior surface of the right knee with an automated anthropometer. Pressure is momentarily applied with the pressure-transducer paddle-blade on the posterior surface of the buttock. An assistant is required to assure that the infant is in the correct position.

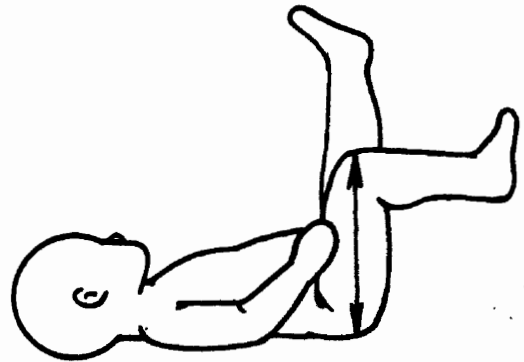
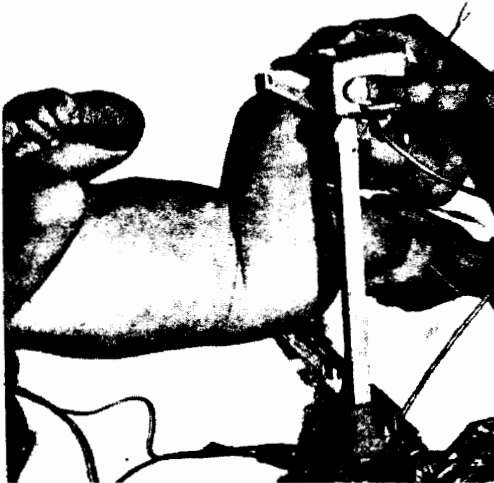

Description: CHILD: Child sits erect, feet resting on platform adjusted for 90° knee flexion, arms resting at side with hands resting on thighs. Measure the parallel distance from posterior surface of right buttock to anterior surface of right knee with an automated anthropometer. Pressure is applied momentarily with the pressure-transducer paddle-blade on the posterior surface of the buttock.

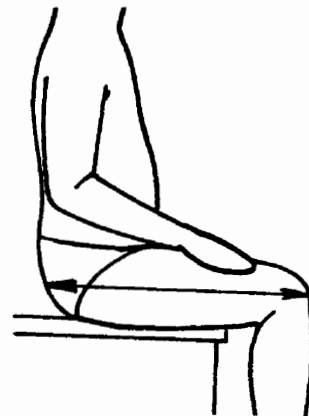
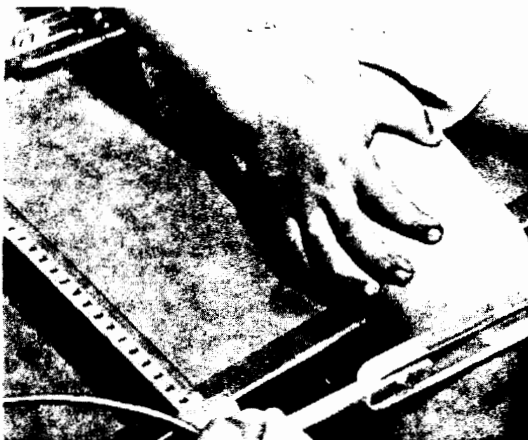

BUTTOCK-KNEE (RUMP-KNEE), IN CMS. • COMBINED SEXES

AGE (MO/YRS)	N	MEAN	S.D.	5%	50%	95%	
0= 3	132	13.7	1.3	11.4	13.5	16.1	
4= 6	90	16.3	1.3	14.0	16.3	18.1	
7= 9	46	17.9	1.1	15.8	17.8	19.8	
10= 12	1	32	19.2	1.4	17.2	19.0	22.0
13= 18	39	20.9	1.9	17.1	21.0	24.2	
19= 24	2	55	23.8	2.0	20.0	23.8	26.9
25= 30	58	25.4	1.8	21.7	25.5	27.7	
31= 36	3	100	27.5	2.0	23.5	27.3	30.9
37= 42	256	28.8	1.8	25.6	28.8	31.7	
43= 48	4	275	30.0	1.8	27.1	30.0	32.8
49= 54	333	31.3	2.0	28.0	31.2	34.5	
55= 60	5	322	32.5	1.9	29.3	32.3	35.8
61= 66	233	34.0	2.0	30.6	34.0	37.5	
67= 72	6	169	35.2	2.1	31.6	35.1	38.8
73= 78	172	36.2	2.2	32.4	36.3	39.9	
79= 84	7	166	37.7	2.1	34.5	37.8	41.5
85= 96	8	257	39.6	2.5	35.4	39.6	43.7
97=108	9	256	42.1	2.6	38.3	41.9	46.7
109=120	10	216	43.9	2.7	39.6	43.6	48.8
121=132	11	185	46.8	2.9	42.3	46.5	51.8
133=144	12	103	48.6	2.7	44.2	48.6	53.4
145=156	13	48	51.3	3.2	45.8	51.0	55.9

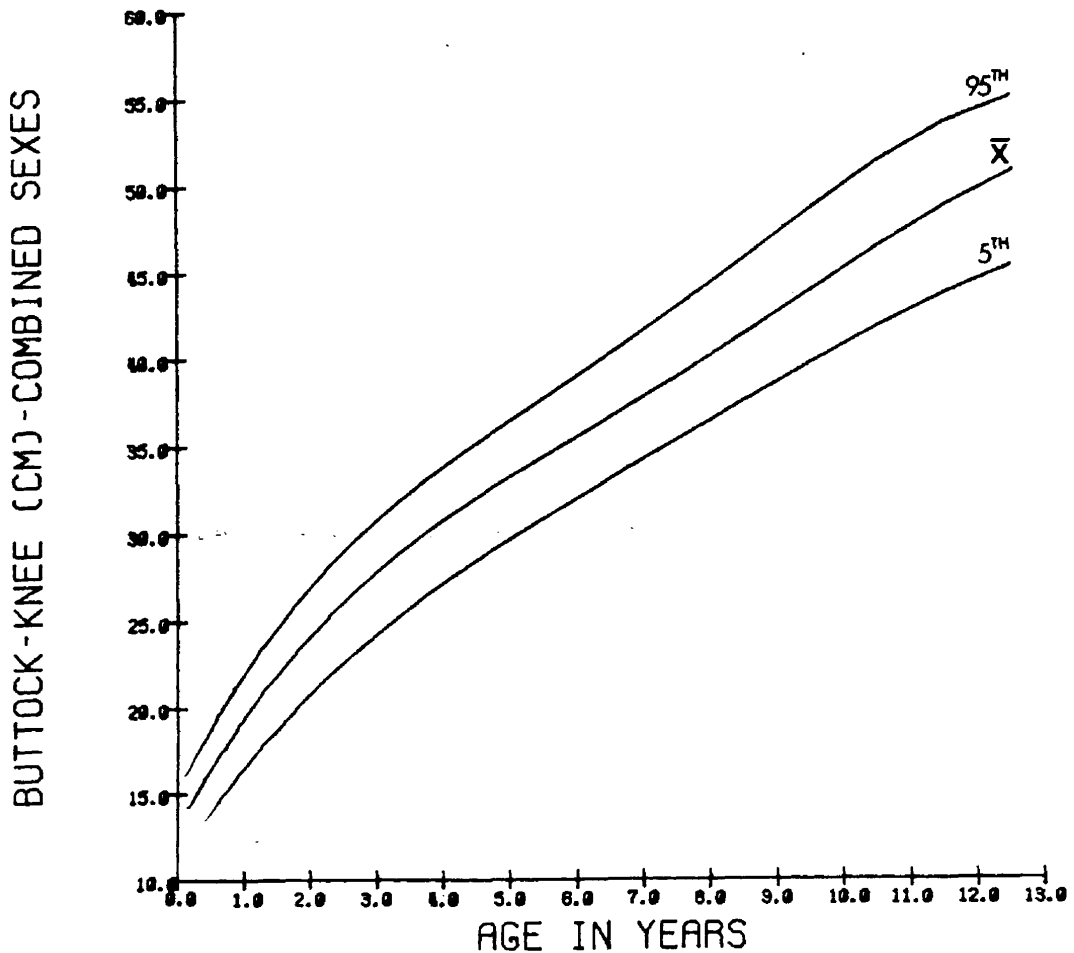

BUTTOCK-KNEE (RUMP-KNEE), IN CMS. - FEMALES

AGE (MO/YRS)	N	MEAN	S.D.	5%	50%	95%
0- 3	60	13.8	1.3	11.1	13.7	15.9
4- 6	49	16.2	1.3	14.1	16.2	17.8
7- 9	26	17.6	0.9	15.7	17.6	18.9
10- 12 1	19	19.3	1.4	17.5	18.7	22.6
13- 18	17	21.2	1.7	18.2	20.9	24.3
19- 24 2	25	23.8	2.3	18.8	23.8	27.0
25- 30	29	25.5	1.8	22.4	25.3	28.8
31- 36 3	52	27.7	2.1	24.2	27.4	30.9
37- 42	136	28.9	1.9	25.6	29.0	32.0
43- 48 4	162	30.1	1.8	27.0	30.2	32.7
49- 54	180	31.5	1.7	28.5	31.4	34.5
55- 60 5	172	32.5	2.0	29.1	32.3	35.9
61- 66	117	34.1	2.0	30.5	34.0	37.5
67- 72 6	82	35.3	2.1	31.4	35.1	38.8
73- 78	99	36.5	2.4	32.3	36.4	40.3
79- 84 7	91	37.7	2.6	34.6	37.8	41.3
85- 96 8	138	39.6	2.4	35.8	39.6	43.6
97-108 9	142	42.5	2.6	38.5	42.2	46.7
109-120 10	130	44.1	2.7	40.2	43.8	49.0
121-132 11	95	47.1	3.2	41.8	46.8	52.1
133-144 12	59	48.7	2.9	43.8	48.9	53.9
145-156 13	32	52.0	3.1	46.8	52.7	55.9

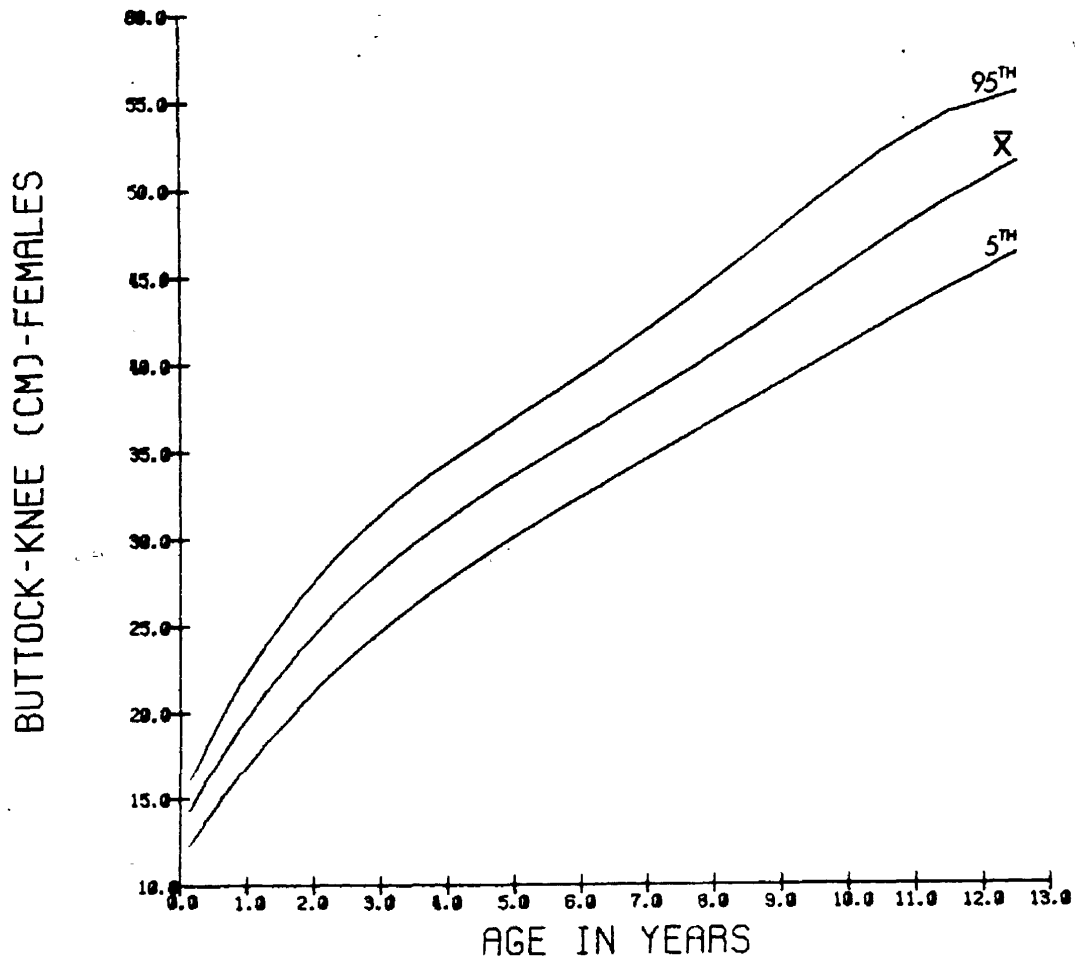

BUTTOCK-KNEE (RUMP-KNEE), IN CMS. - MALES

AGE (MO/YRS)	N	MEAN	S.D.	5%	50%	95%
0- 3	72	13.7	1.3	11.7	13.3	16.1
4- 6	41	16.5	1.3	13.9	16.6	18.2
7- 9	20	18.4	1.2	15.9	18.8	20.3
10- 12	13	19.2	1.3	16.9	19.0	22.2
13- 18	22	20.7	2.0	16.5	21.0	23.1
19- 24	2	23.9	1.8	21.5	23.5	26.7
25- 30	29	25.4	1.8	21.8	25.6	27.6
31- 36	3	27.2	1.9	23.3	27.2	30.1
37- 42	120	28.7	1.6	25.3	28.6	31.4
43- 48	4	29.8	1.7	27.2	29.7	32.7
49- 54	153	31.1	2.2	27.8	30.9	34.2
55- 60	150	32.5	1.8	29.4	32.3	35.7
61- 66	116	33.8	2.1	30.6	34.0	37.2
67- 72	6	35.1	2.1	31.6	35.0	38.8
73- 78	73	35.9	1.9	32.6	35.8	39.3
79- 84	75	37.8	2.2	33.4	37.6	41.3
85- 96	8	39.6	2.6	35.3	39.5	44.2
97-108	9	41.5	2.4	37.8	41.4	46.2
109-120	10	43.5	2.8	39.3	43.4	47.7
121-132	11	46.4	2.4	42.5	46.3	50.8
133-144	12	48.5	2.4	44.3	48.5	53.0
145-156	13	50.0	3.1	44.9	49.2	56.0

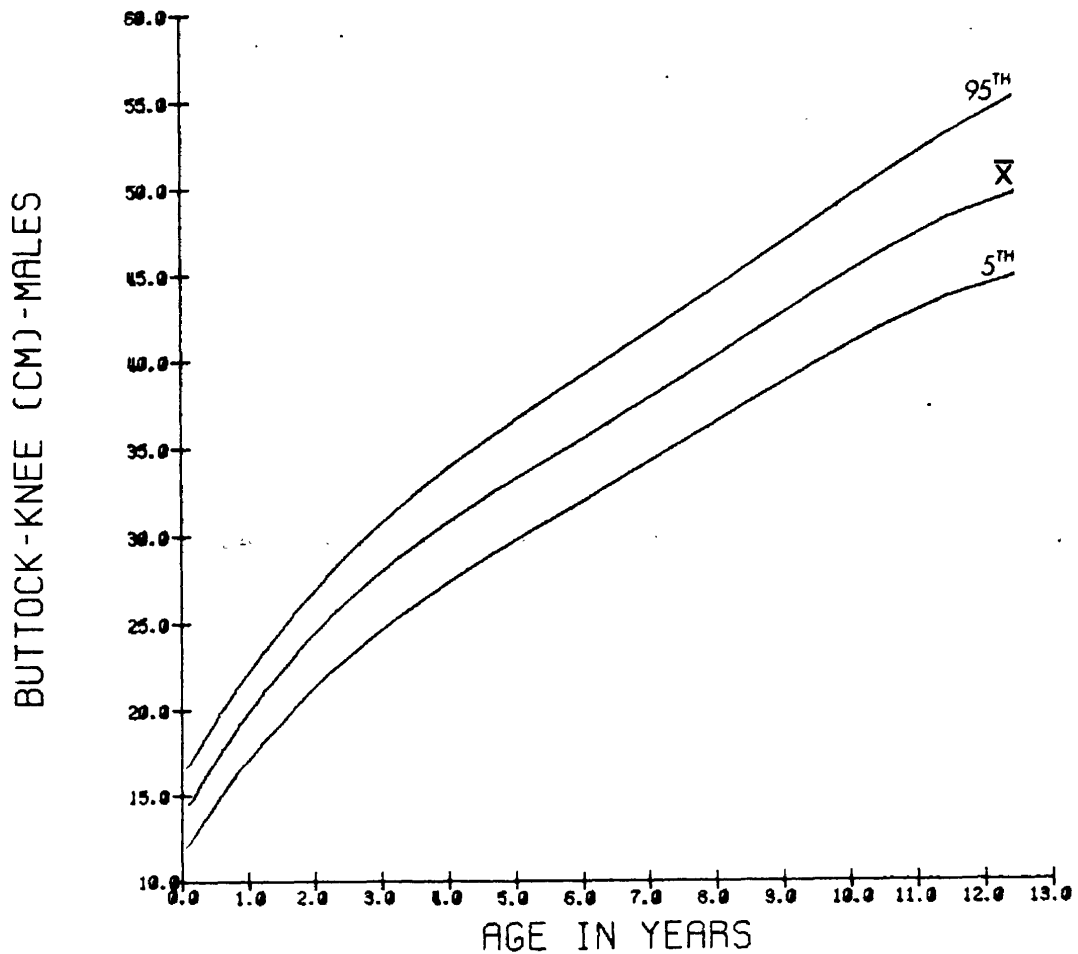

### KNEE-SOLE LENGTH

Device: Automated anthropometer equipped with pressure transducer in paddle blade. Measurements are recorded automatically by computer at fixed pressure values.

Description: INFANT: Infant lies on back with 90° right knee flexion. Measure the parallel distance from top of right knee to the heel of the right foot with an automated anthropometer. Pressure is momentarily applied with the pressure-transducer paddle-blade on the superior surface of the knee. An assistant is required to assure that the infant is in the correct position.

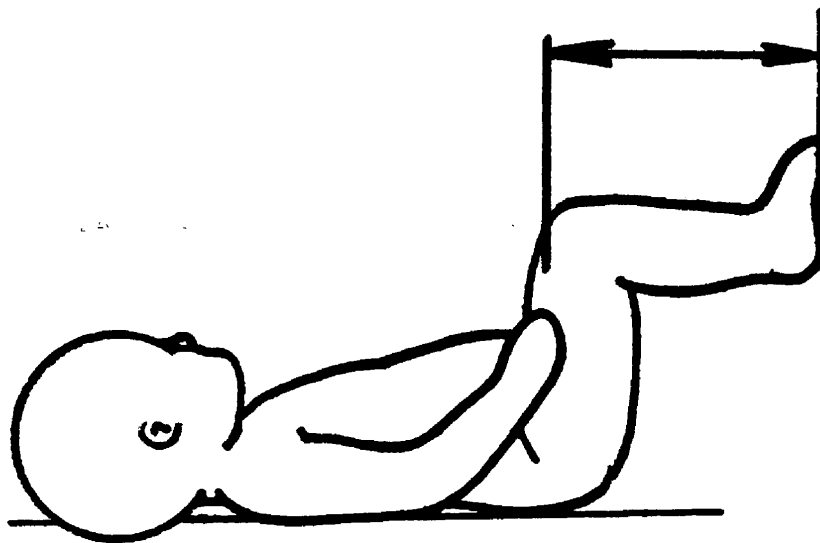

## KNEE HEIGHT

Device: Automated anthropometer. Measurements are recorded automatically by computer.

Description: CHILD: Child sits erect, left foot resting on platform adjusted for 90° knee flexion, arms resting at side, with hands on thighs. The heel of the right foot rests on the immobile paddle blade of the automated anthropometer. Pressure is applied momentarily with the pressure-transducer paddle-blade on the superior surface of the knee.

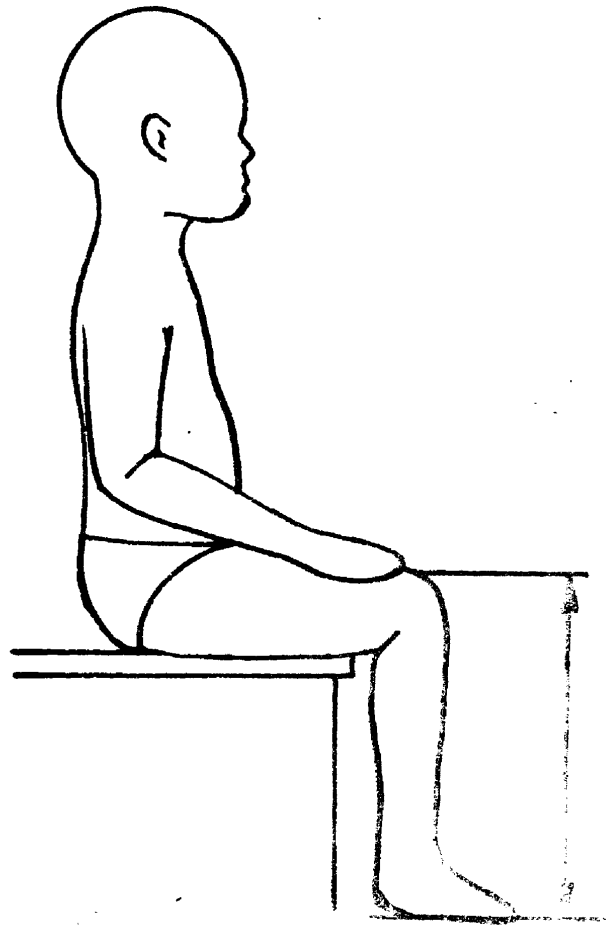

KNEE HEIGHT (KNEE-SOLE), IN CMS. - COMBINED SEXES

AGE (MO/YRS)	N	MEAN	S.D.	5%	50%	95%	
0= 3	139	14.2	1.3	12.1	14.1	16.3	
4= 6	98	16.7	1.0	14.9	16.7	18.5	
7= 9	50	18.3	0.9	16.5	18.4	19.5	
10= 12	1	35	1.1	17.2	19.7	21.2	
13= 18	51	21.4	1.3	19.2	20.9	23.3	
19= 24	2	65	23.6	1.5	20.4	23.9	25.7
25= 30	63	25.4	1.4	22.9	25.5	27.6	
31= 36	3	101	27.0	1.6	24.6	26.9	29.7
37= 42	266	28.3	1.4	26.0	28.1	30.7	
43= 48	4	284	29.2	1.5	26.7	29.0	31.6
49= 54	351	30.6	1.5	28.1	30.5	33.4	
55= 60	5	323	31.8	1.7	29.0	31.6	34.5
61= 66	237	33.0	1.8	30.0	32.8	35.8	
67= 72	6	171	34.0	1.9	30.6	33.9	37.1
73= 78	173	35.1	1.9	32.0	35.1	38.5	
79= 84	7	172	36.2	1.9	33.1	36.3	39.3
85= 96	8	276	38.0	2.2	34.3	37.9	41.5
97=108	9	274	40.5	2.4	36.6	40.6	44.5
109=120	10	253	42.0	2.4	38.2	41.8	45.9
121=132	11	200	44.5	2.5	40.6	44.2	49.0
133=144	12	115	46.2	2.7	41.6	45.8	50.9
145=156	13	51	48.4	2.6	44.0	48.1	52.3

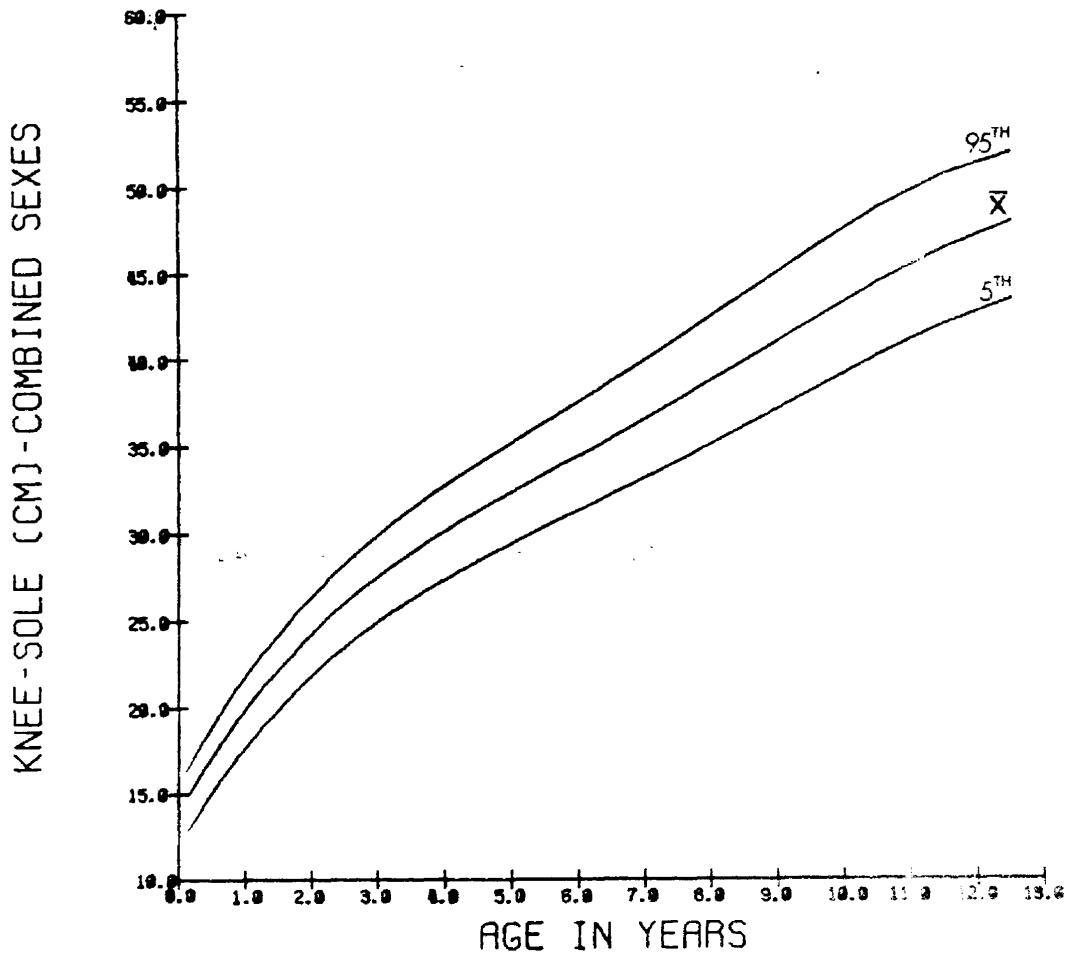



KNEE HEIGHT (KNEE-SOLE), IN CMS. - FEMALES

AGE (MO/YRS)	N	MEAN	S.D.	5%	50%	95%
0- 3	62	14.0	1.1	12.0	13.9	16.0
4- 6	53	16.4	1.0	14.7	16.3	17.8
7- 9	27	18.1	0.8	16.1	18.1	19.2
10- 12 1	20	19.3	1.2	17.1	19.5	21.4
13- 18	23	21.0	1.2	19.0	20.5	23.2
19- 24 2	27	23.4	1.5	20.3	23.8	25.3
25- 30	30	25.5	1.3	22.8	25.5	27.6
31- 36 3	53	26.7	1.5	24.6	26.2	29.5
37- 42	138	28.2	1.5	25.6	28.1	30.7
43- 48 4	163	29.1	1.5	26.6	29.0	31.5
49- 54	185	30.5	1.6	28.0	30.5	33.1
55- 60 5	173	31.6	1.7	29.0	31.6	34.5
61- 66	118	32.9	1.7	29.5	32.8	35.8
67- 72 6	80	34.0	1.9	30.4	33.8	37.4
73- 78	99	35.0	1.9	31.7	34.9	38.4
79- 84 7	94	36.0	1.8	32.4	36.3	38.8
85- 96 8	145	37.8	2.1	34.5	37.8	41.2
97-108 9	144	40.8	2.5	36.5	40.8	45.4
109-120 10	148	41.9	2.3	38.7	41.7	45.9
121-132 11	103	44.4	2.7	39.5	44.0	49.5
133-144 12	63	45.7	2.6	41.1	45.6	50.5
145-156 13	31	49.0	2.1	45.4	49.1	52.3

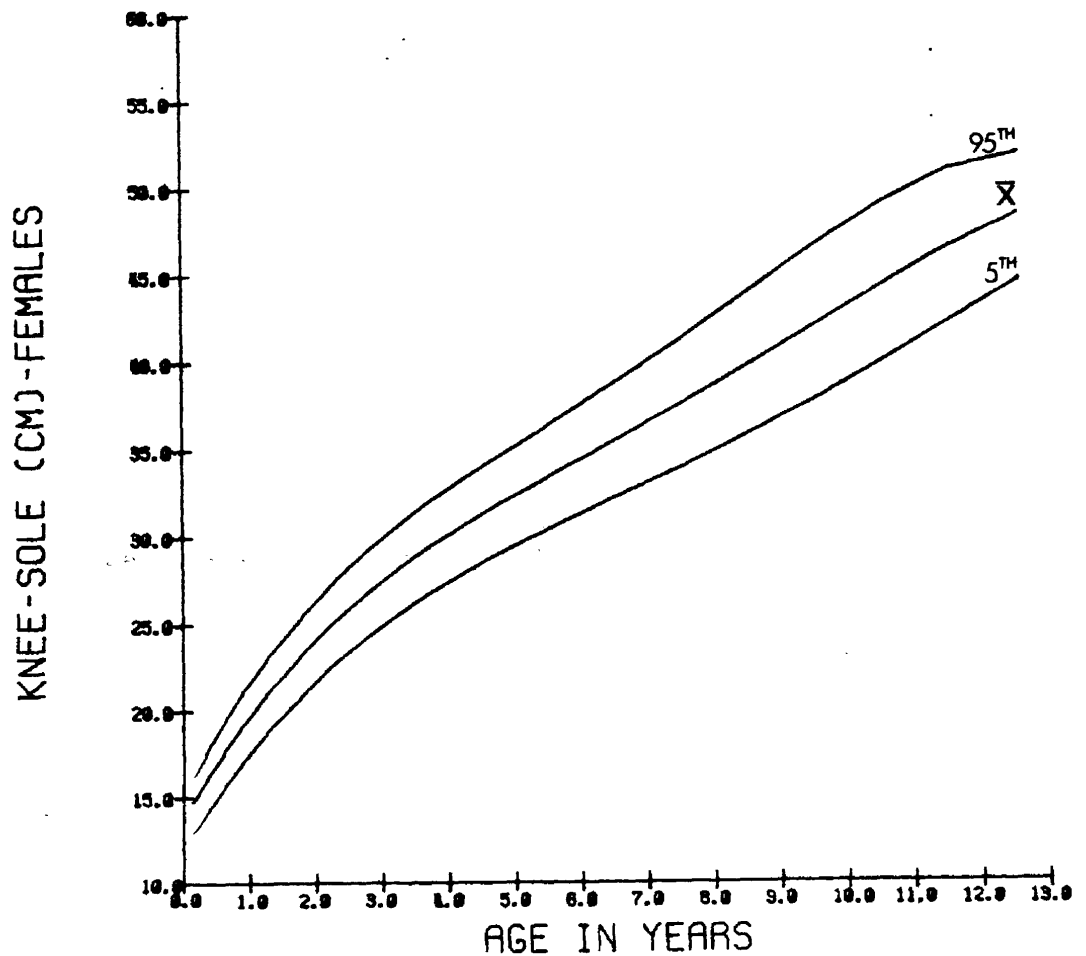

KNEE HEIGHT (KNEE-SOLE), IN CMS. - MALES

AGE (MO/YRS)	N	MEAN	S.D.	5%	50%	95%
0= 3	77	14.4	1.4	12.3	14.5	16.6
4= 6	45	17.1	1.0	15.2	17.0	18.6
7= 9	23	18.6	1.0	16.6	18.8	19.6
10= 12 1	15	20.1	0.8	18.9	19.9	22.2
13= 18	28	21.7	1.3	19.5	21.5	23.7
19= 24 2	38	23.8	1.6	20.5	23.9	26.0
25= 30	33	25.4	1.6	22.7	25.3	27.5
31= 36 3	48	27.2	1.6	24.5	27.3	29.8
37= 42	128	28.3	1.3	26.3	28.2	30.6
43= 48 4	121	29.3	1.4	27.0	29.1	32.0
49= 54	166	30.8	1.5	28.3	30.6	33.6
55= 60 5	150	31.9	1.7	28.7	31.7	34.5
61= 66	119	33.1	1.8	30.0	32.8	35.9
67= 72 6	91	34.1	1.8	30.7	34.0	36.8
73= 78	74	35.3	1.8	32.0	35.2	38.4
79= 84 7	78	36.5	2.0	33.3	36.4	39.7
85= 96 8	131	38.3	2.3	34.2	38.2	41.8
97=108 9	130	40.2	2.2	36.7	40.4	43.5
109=120 10	105	42.2	2.5	37.8	42.0	45.8
121=132 11	97	44.6	2.1	40.9	44.6	47.9
133=144 12	52	46.8	2.7	42.2	46.5	51.2
145=156 13	20	47.5	3.0	42.1	47.4	55.5

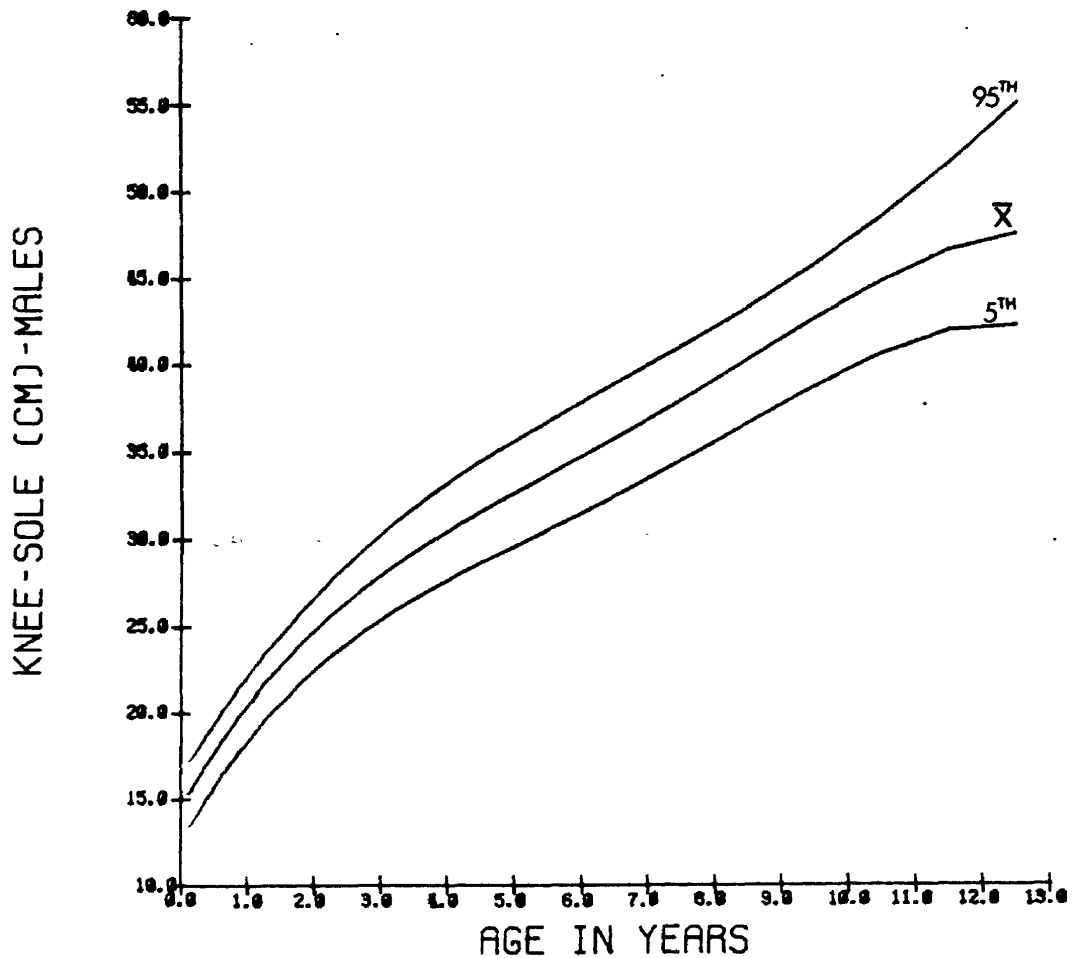

## BUTTOCK-FOOT (RUMP-SOLE) LENGTH

Device: Automated anthropometer equipped with pressure transducer in paddle blade. Measurements are recorded automatically by computer at fixed pressure values.

Description: INFANT: Infant lies on left side with 90° hip flexion. The right leg is fully extended. Measure the parallel distance from posterior surface of the right buttock to the heel of the right foot with an automated anthropometer. Pressure is momentarily applied with the pressure-transducer paddle-blade on the posterior surface of the buttock. An assistant is required to assure that the infant is in the correct position.

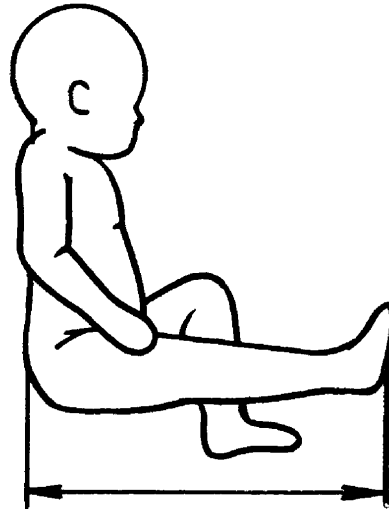
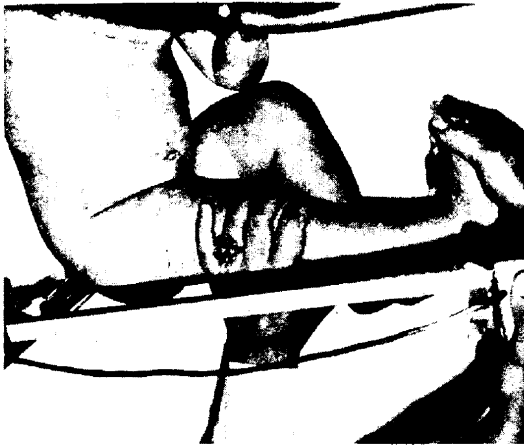

Description: CHILD: Child sits erect with legs fully extended and 90° hip flexion, arms hanging at side. Measure the parallel distance from buttock to heel of right foot with a standard anthropometer.

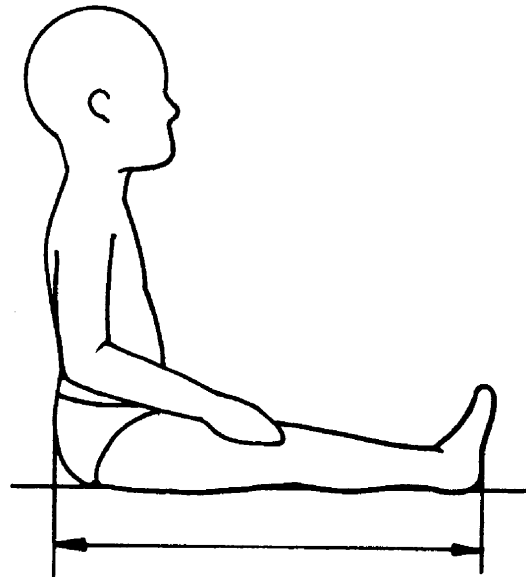

BUTTOCK-FOOT (RUMP-SOLE), IN CMS. - COMBINED SEXES

AGE (MO/YRS)	N	MEAN	S.D.	5%	50%	95%
0- 3	131	23.4	1.9	20.1	23.1	26.2
4- 6	88	28.3	2.0	24.4	28.1	31.4
7- 9	44	31.3	1.6	28.5	31.5	33.4
10- 12	1	32.5	1.6	31.6	34.4	36.8
13- 18	39	37.3	2.5	33.8	36.3	41.3
19- 24	2	42.4	2.7	36.9	42.3	46.6
25- 30	53	45.5	2.7	40.9	45.5	49.2
31- 36	3	49.2	3.4	43.4	49.0	55.1
37- 42	257	51.6	2.7	47.1	51.4	56.2
43- 48	4	53.6	2.8	48.8	53.4	58.4
49- 54	331	56.0	2.9	51.8	55.7	60.9
55- 60	318	58.1	3.2	52.5	58.0	63.4
61- 66	233	60.6	3.5	54.7	60.4	66.3
67- 72	169	62.7	3.3	56.9	62.7	68.3
73- 78	162	64.5	3.5	57.9	64.6	69.8
79- 84	163	67.1	3.4	61.6	67.1	73.5
85- 96	238	70.1	4.1	63.5	70.1	76.8
97-108	253	74.6	4.4	67.7	74.4	82.9
109-120	10	77.6	4.6	70.8	77.2	84.9
121-132	185	82.6	4.8	74.5	82.4	90.7
133-144	103	85.8	4.9	77.0	85.7	94.8
145-156	46	90.5	5.4	81.9	89.9	98.7

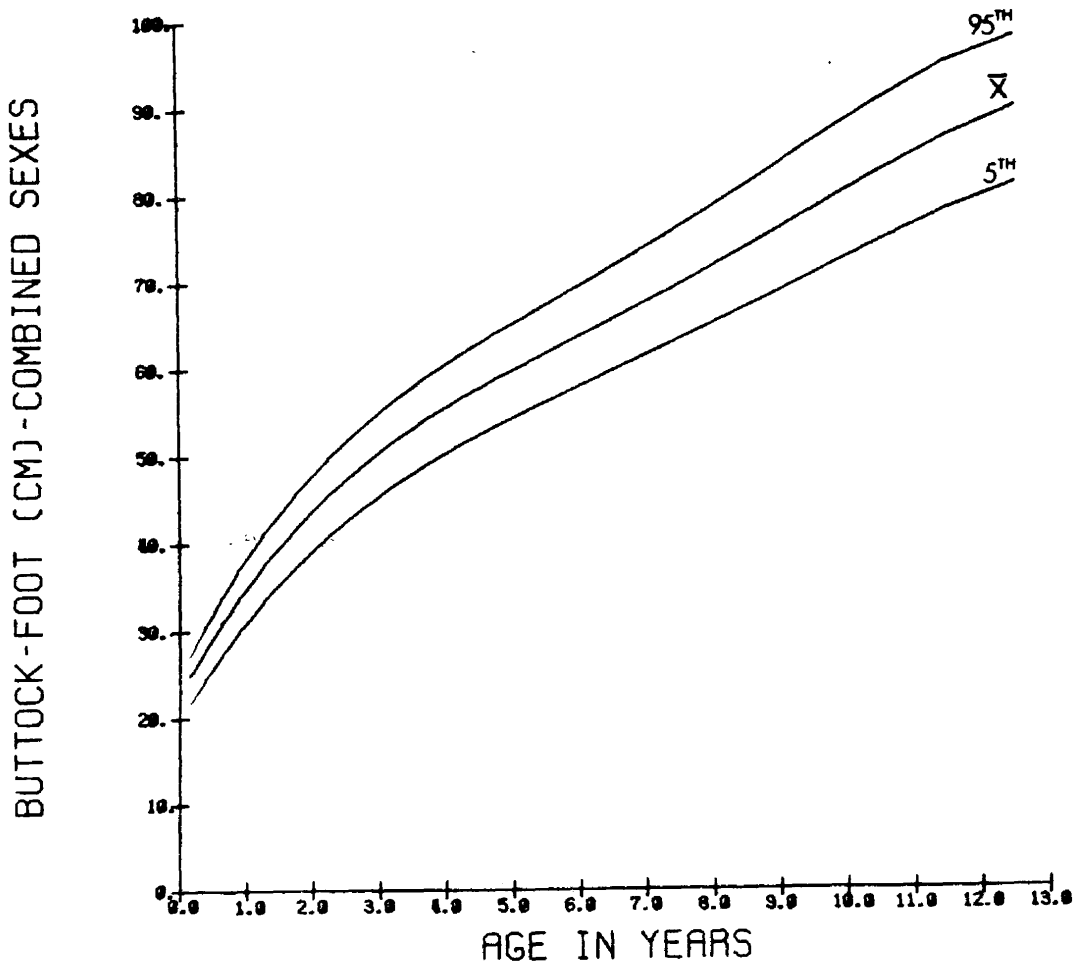

BUTTOCK-FOOT(RUMP-SOLE), IN CMS. - FEMALES

AGE(MO/YRS)	N	MEAN	S.D.	5%	50%	95%
0- 3	60	23.3	1.9	19.6	23.1	26.2
4- 6	47	28.0	2.0	23.8	28.1	30.8
7- 9	25	31.0	1.5	27.7	31.1	33.1
10- 12	1	19	34.1	1.5	31.7	33.6
13- 18	17	37.2	2.7	32.7	35.9	41.8
19- 24	2	25	42.4	3.0	35.8	43.1
25- 30	26	46.0	2.8	41.7	45.7	51.7
31- 36	3	52	49.4	3.4	43.1	48.8
37- 42	136	51.6	2.8	46.8	51.4	56.3
43- 48	4	159	53.8	2.8	48.7	53.8
49- 54	181	56.1	2.9	52.1	55.8	60.8
55- 60	5	169	58.0	3.2	52.5	57.9
61- 66	118	60.8	3.4	54.5	60.5	66.3
67- 72	6	81	63.0	3.5	56.9	62.4
73- 78	91	64.6	3.7	57.5	64.5	69.8
79- 84	7	92	67.0	3.5	61.3	67.1
85- 96	8	126	69.9	4.0	63.2	69.6
97-108	9	140	75.4	4.4	68.4	74.9
109-120	10	132	77.8	4.4	72.1	77.2
121-132	11	94	83.0	5.2	73.3	82.7
133-144	12	59	85.6	5.0	76.7	85.7
145-156	13	31	92.2	4.9	83.8	93.1

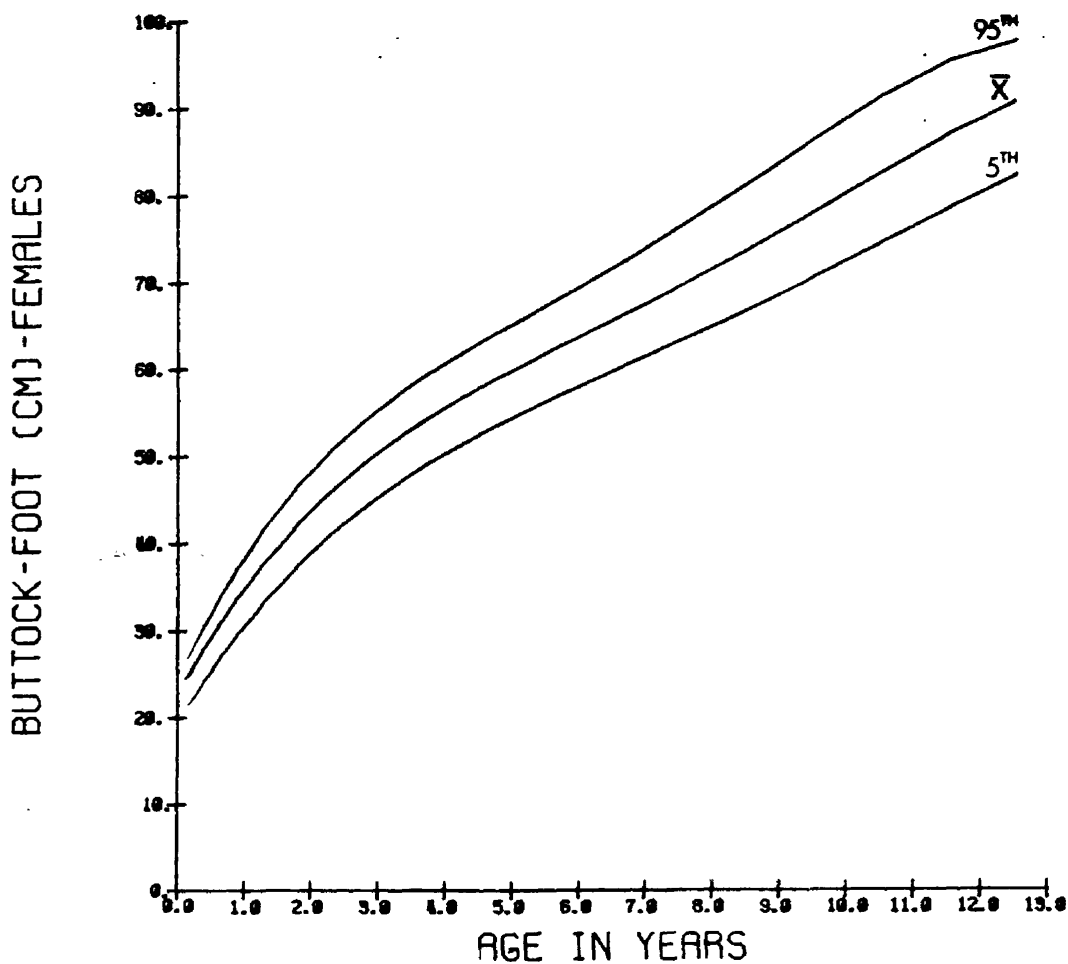

BUTTOCK-FOOT(RUMP-SOLE), IN CMS. • MALES

AGE(MO/YRS)	N	MEAN	S.D.	5%	50%	95%	
0- 3	71	23.5	1.9	20.2	23.2	26.3	
4- 6	41	28.6	2.0	24.4	28.4	31.5	
7- 9	19	31.7	1.6	28.4	32.1	33.9	
10- 12	1	13	35.0	1.7	31.6	35.0	37.8
13- 18	22	37.3	2.4	33.1	36.4	40.8	
19- 24	2	30	42.5	2.5	38.3	41.8	46.6
25- 30	27	45.0	2.6	40.1	44.9	48.7	
31- 36	3	48	48.9	3.5	43.0	49.0	55.1
37- 42	121	51.7	2.5	47.2	51.4	56.1	
43- 48	4	113	53.4	2.9	49.0	52.8	58.1
49- 54	150	56.0	2.9	51.7	55.6	60.9	
55- 60	5	149	58.2	3.3	52.5	58.0	63.6
61- 66	115	60.3	3.6	54.9	60.1	66.1	
67- 72	6	88	62.5	3.2	57.1	62.7	67.1
73- 78	71	64.4	3.2	58.0	64.6	68.8	
79- 84	7	71	67.2	3.4	61.6	67.1	72.9
85- 96	8	112	70.5	4.3	63.3	70.6	77.5
97-108	9	113	73.7	4.2	67.3	73.7	80.6
109-120	10	85	77.3	4.9	69.6	77.2	84.6
121-132	11	91	82.3	4.3	74.6	82.1	88.5
133-144	12	44	86.1	4.9	77.3	85.5	94.8
145-156	13	15	86.9	4.6	80.2	86.3	99.0

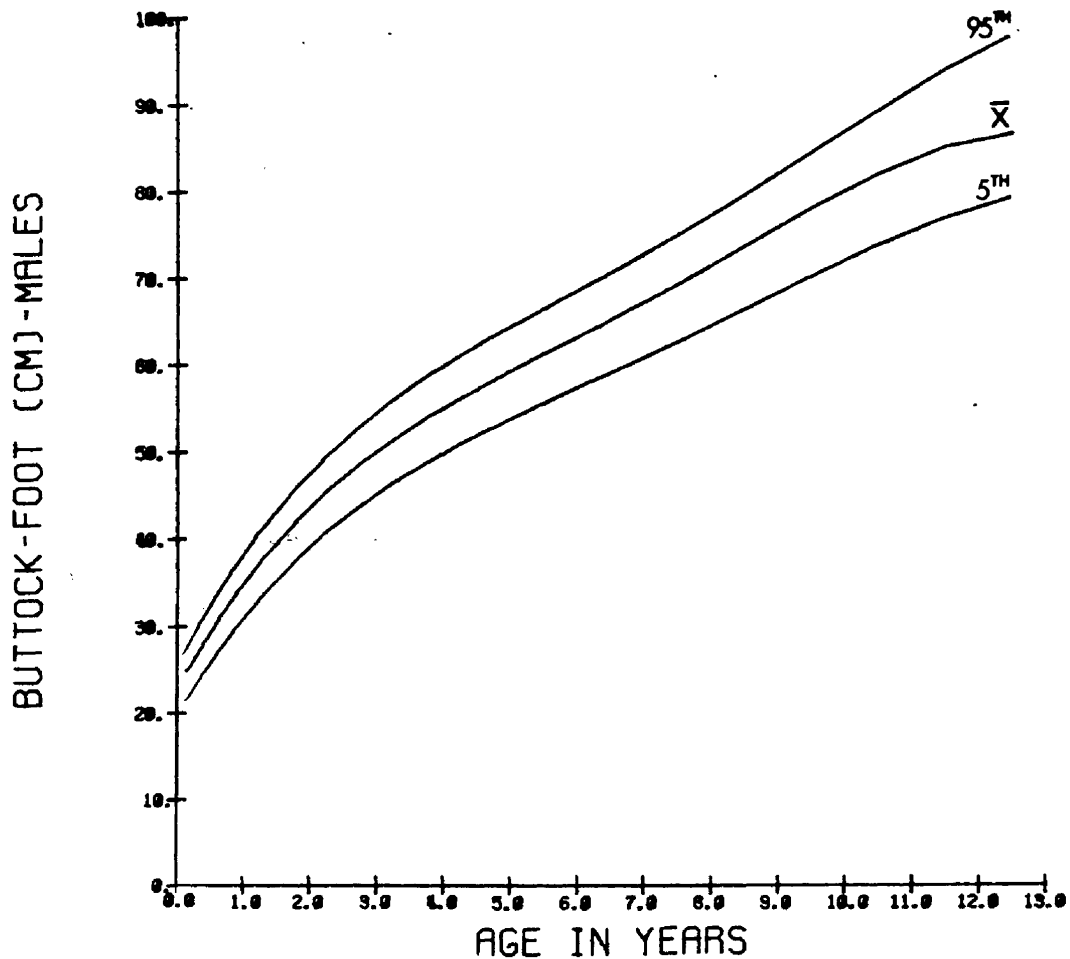

## SHOULDER-ELBOW LENGTH

Device: Automated anthropometer or sliding caliper. Measurements are recorded automatically by computer.

Description: INFANT: Infant lies on back with upper arm resting against body and elbow flexed 90°. Measure the parallel distance from the superior surface of the right shoulder to the interior surface of the right forearm with an automated sliding caliper. The paddle blades firmly contact the two body surfaces for measurement. An assistant is required to assure that the infant is in the correct position.

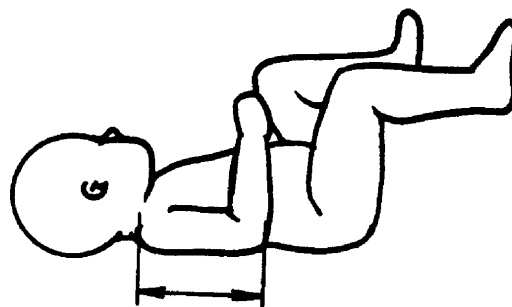

Description: CHILD: Child sits erect, upper arms resting at side with elbow flexed 90°. Measure the parallel distance from the superior surface of the right shoulder to the interior surface of the right forearm with an automated anthropometer. The paddle-blades firmly contact the two body surfaces for measurement.

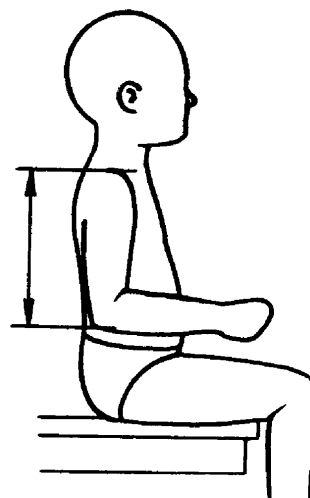
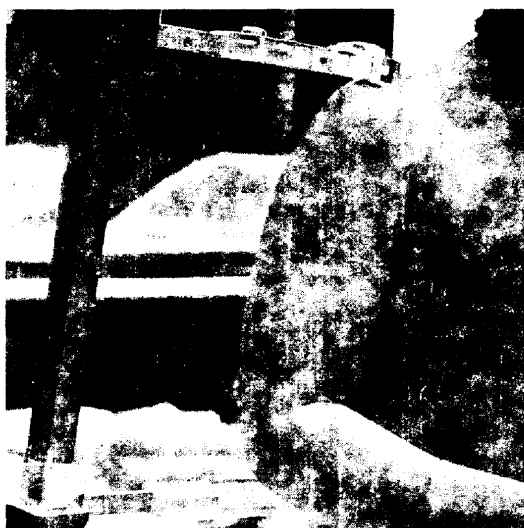

SHOULDER-ELBOW LENGTH, IN CMS. - COMBINED SEXES

AGE (MO/YRS)	N	MEAN	S.D.	5%	50%	95%
0- 3	140	10.8	0.8	9.2	10.7	12.2
4- 6	100	12.6	0.8	11.0	12.6	14.0
7- 9	53	13.7	0.7	12.2	13.8	14.8
10- 12	41	14.5	0.6	13.4	14.5	15.4
13- 18	55	15.5	0.8	13.7	15.4	16.8
19- 24	2	17.0	0.9	15.2	17.1	18.3
25- 30	63	18.1	1.1	16.4	18.0	20.1
31- 36	3	18.9	1.0	17.2	18.7	20.7
37- 42	264	19.7	1.0	18.0	19.6	21.5
43- 48	4	20.3	1.1	18.4	20.3	22.1
49- 54	348	21.2	1.1	19.4	21.1	23.1
55- 60	5	21.9	1.2	19.9	21.9	23.9
61- 66	239	22.6	1.2	20.5	22.5	24.6
67- 72	171	23.4	1.3	21.1	23.4	25.4
73- 78	175	24.0	1.3	21.5	23.9	26.0
79- 84	7	24.7	1.3	22.5	24.7	27.0
85- 96	8	25.8	1.5	23.3	25.9	28.3
97-100	9	27.3	1.4	24.9	27.2	29.7
100-120	10	28.2	1.4	25.8	28.1	30.6
121-132	11	29.8	1.6	27.4	29.7	32.5
133-144	12	31.0	1.7	28.0	30.8	34.0
145-156	13	32.6	1.9	29.1	32.8	35.4

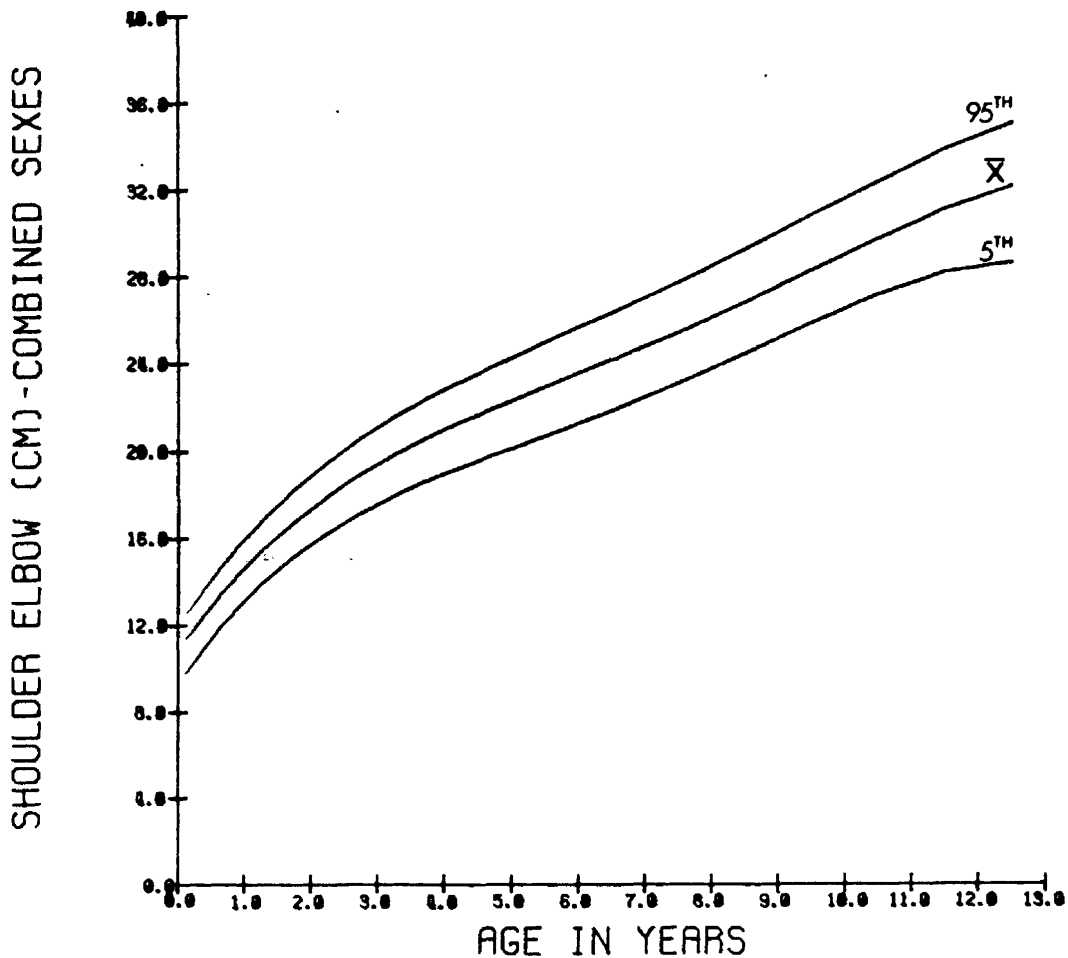



SHOULDER-ELBOW LENGTH, IN CMS. - FEMALES

AGE(MO/YRS)	N	MEAN	S.D.	5%	50%	95%
0= 3	64	10.6	0.8	9.2	10.6	11.9
4= 6	56	12.4	0.9	10.6	12.5	13.7
7= 9	28	13.5	0.7	12.2	13.5	14.5
10= 12 1	23	14.4	0.7	13.4	14.3	15.3
13= 18	24	15.4	0.7	13.5	15.4	16.4
19= 24 2	29	16.9	1.0	15.2	17.1	18.2
25= 30	30	18.0	0.9	16.6	18.0	19.6
31= 36 3	54	18.7	1.0	16.8	18.5	20.4
37= 42	139	19.5	1.1	17.6	19.4	21.5
43= 48 4	163	20.3	1.1	18.5	20.3	22.0
49= 54	184	21.1	1.0	19.4	21.0	22.8
55= 60 5	171	21.8	1.2	19.9	21.8	23.7
61= 66	116	22.4	1.2	20.3	22.2	24.6
67= 72 6	81	23.4	1.2	21.0	23.3	25.3
73= 78	98	23.9	1.3	21.5	23.9	26.0
79= 84 7	94	24.6	1.3	22.2	24.6	26.6
85= 96 8	145	25.6	1.3	23.4	25.5	27.9
97=108 9	144	27.3	1.4	25.2	27.1	29.7
109=120 10	150	28.1	1.3	26.0	28.0	30.4
121=132 11	104	29.8	1.8	27.0	29.5	32.7
133=144 12	63	30.8	1.7	27.8	30.6	33.3
145=156 13	32	33.2	1.7	29.6	33.4	35.2

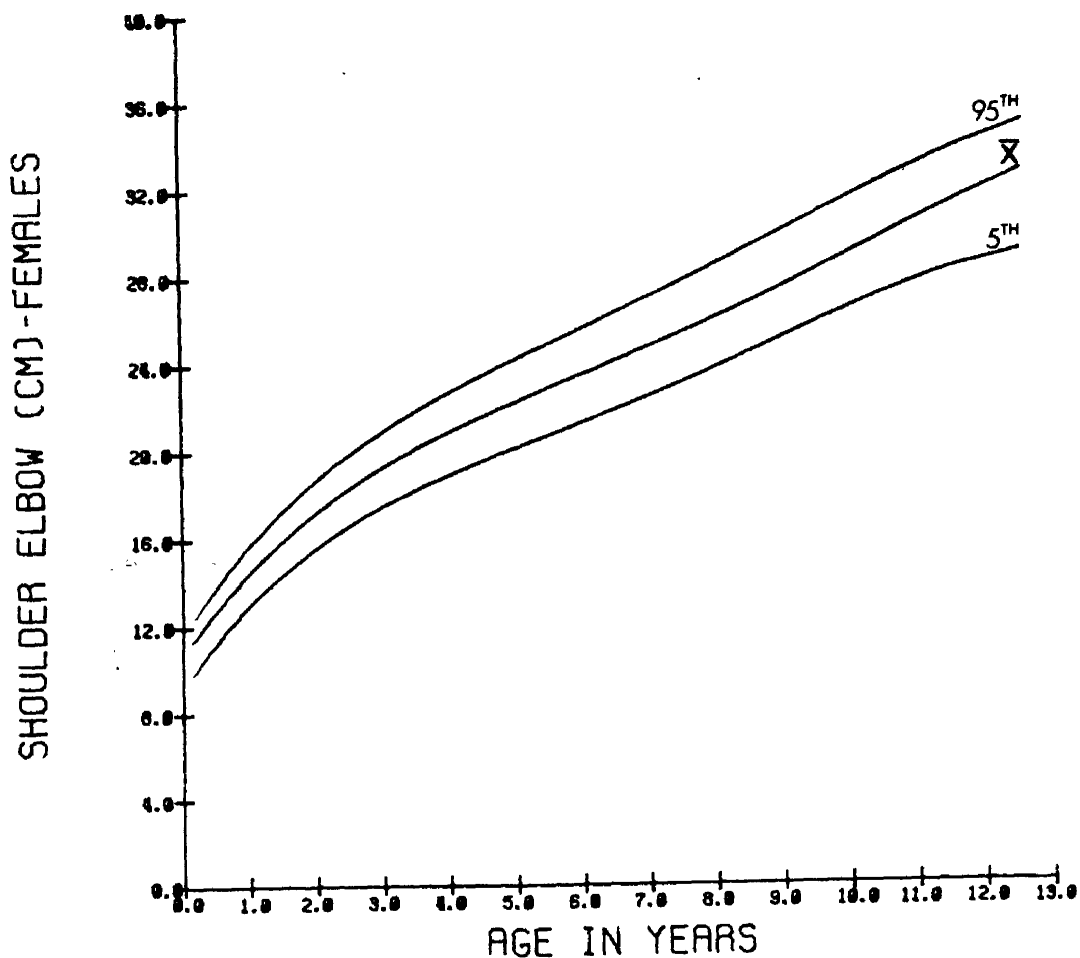

SHOULDER-ELBOW LENGTH, IN CMS, - MALES

AGE(MO/YRS)	N	MEAN	S.D.	5%	50%	95%
0= 3	76	10.9	0.9	9.2	10.8	12.5
4= 6	44	12.9	0.7	11.5	12.8	14.1
7= 9	25	13.9	0.7	12.2	13.9	14.8
10= 12 1	18	14.7	0.6	13.9	14.6	16.1
13= 18	31	15.6	0.9	13.9	15.5	16.8
19= 24 2	42	17.2	0.9	15.3	17.2	18.5
25= 30	33	18.1	1.2	15.9	18.0	20.3
31= 36 3	49	19.2	1.0	17.4	19.0	20.9
37= 42	125	19.9	0.9	18.2	19.8	21.7
43= 48 4	120	20.4	1.1	18.4	20.4	22.4
49= 54	164	21.4	1.1	19.5	21.2	23.4
55= 60 5	154	22.1	1.3	20.2	22.0	24.1
61= 66	123	22.8	1.2	20.8	22.8	24.5
67= 72 6	90	23.4	1.3	21.1	23.5	25.6
73= 78	77	24.1	1.2	21.6	23.8	26.1
79= 84 7	77	24.9	1.3	22.9	24.7	27.2
85= 96 8	135	26.1	1.6	23.2	26.1	28.5
97=108 9	132	27.2	1.4	24.7	27.2	29.6
109=120 10	107	28.3	1.5	25.6	28.3	31.2
121=132 11	98	29.9	1.3	27.7	29.8	31.9
133=144 12	53	31.2	1.7	28.4	30.9	34.1
145=156 13	21	31.8	2.0	28.4	31.4	35.5

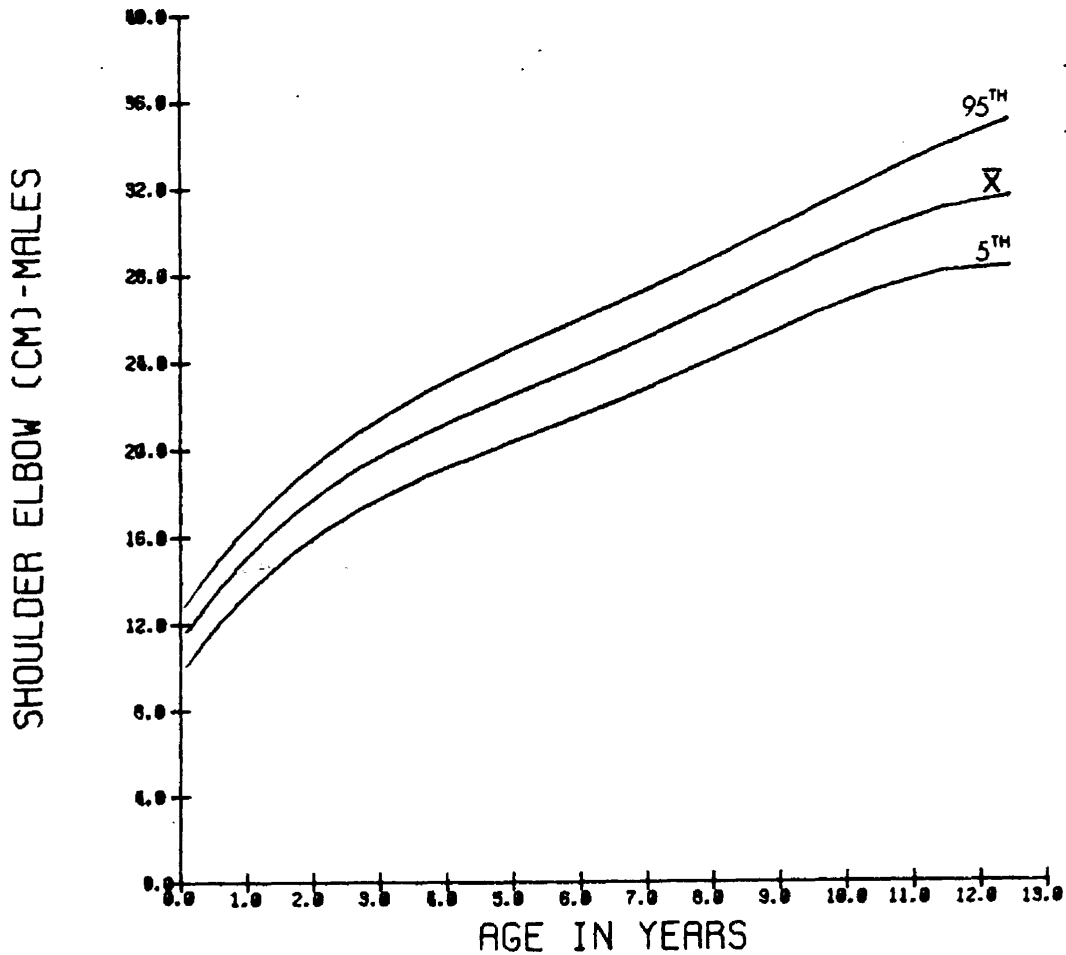

## LOWER ARM LENGTH

Device: Automated anthropometer. Measurements are recorded automatically by computer.

Description: INFANT: Infant lies on back with elbow flexed 90° and right hand and fingers extended. Measure the parallel distance from the posterior surface of the right upper arm, just above the elbow, to the tip of the third digit with an automated anthropometer. The paddle-blades firmly contact the two body surfaces for measurement. An assistant is required to assure that the infant is in the correct position.

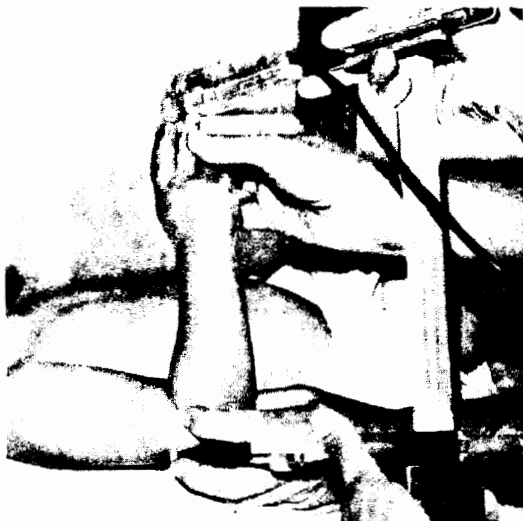

Description: CHILD: Child sits erect, upper arms resting at side, elbow flexed 90° with hands and fingers extended. Measure the parallel distance from the posterior surface of the right upper arm just above the elbow to the tip of the third digit with an automated anthropometer. The paddle-blades firmly contact the two body surfaces for measurement.



LOWER ARM LENGTH, IN CMS. • COMBINED SEXES

AGE(MO/YRS)	N	MEAN	S.D.	5%	50%	95%
0= 3	139	14.8	1.1	13.1	14.8	16.4
4= 6	99	16.9	1.2	14.9	16.8	18.9
7= 9	52	18.4	0.8	17.1	18.5	19.7
10= 12 1	39	19.3	0.9	17.6	19.2	21.0
13= 18	51	20.7	1.0	19.0	20.3	22.5
19= 24 2	70	22.5	1.5	19.5	22.5	24.8
25= 30	63	23.8	1.3	21.2	23.7	26.0
31= 36 3	104	25.0	1.5	22.3	24.9	27.9
37= 42	264	25.8	1.3	23.5	25.7	28.0
43= 48 4	283	26.4	1.5	24.1	26.3	28.9
49= 54	349	27.5	1.4	25.3	27.3	29.9
55= 60 5	327	28.4	1.5	26.0	28.2	30.8
61= 66	240	29.1	1.6	26.4	29.0	31.8
67= 72 6	172	30.0	1.5	27.3	29.8	32.5
73= 78	175	30.6	1.5	28.1	30.7	33.1
79= 84 7	171	31.5	1.6	28.8	31.4	34.3
85= 96 8	280	32.8	1.9	29.7	32.7	35.9
97=108 9	275	34.5	1.9	31.5	34.4	37.9
109=120 10	258	35.6	1.9	32.7	35.5	39.0
121=132 11	203	37.7	2.1	34.3	37.6	41.5
133=144 12	116	39.2	2.2	35.4	39.1	43.2
145=156 13	53	40.9	2.3	36.8	40.6	45.0

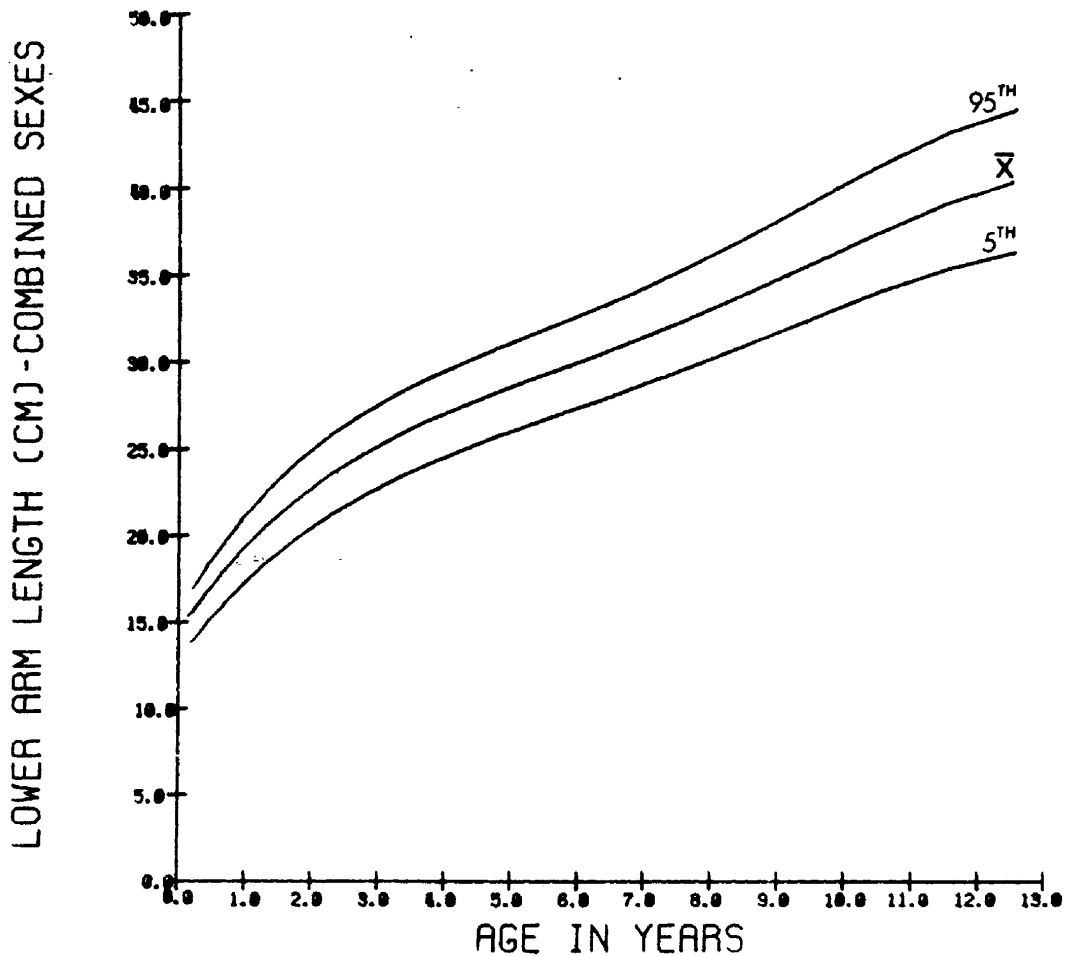

LOWER ARM LENGTH, IN CMS. - FEMALES

AGE (MO/YRS)	N	MEAN	S.D.	5%	50%	95%
0- 3	63	14.7	1.2	13.1	14.8	16.2
4- 6	55	16.5	1.1	14.3	16.5	18.5
7- 9	28	18.2	0.7	16.9	18.5	19.1
10- 12	1	22	0.9	17.5	19.1	20.7
13- 18	23	20.3	0.8	18.3	20.2	21.6
19- 24	2	22.2	1.4	19.5	22.3	24.0
25- 30	30	23.5	1.1	21.2	23.4	25.4
31- 36	3	24.7	1.5	22.1	24.4	27.0
37- 42	136	25.6	1.3	23.3	25.5	27.8
43- 48	4	26.3	1.3	24.0	26.2	28.3
49- 54	184	27.2	1.4	24.8	27.0	29.6
55- 60	5	28.0	1.4	25.7	28.0	30.2
61- 66	116	28.7	1.5	26.0	28.5	31.2
67- 72	6	29.7	1.5	26.9	29.4	32.0
73- 78	98	30.3	1.6	27.6	30.2	32.7
79- 84	7	31.2	1.5	28.8	31.2	33.6
85- 96	8	32.4	1.7	29.3	32.3	35.1
97-108	9	34.4	2.0	31.2	34.3	38.3
109-120	10	35.4	1.8	32.6	35.2	38.2
121-132	11	37.5	2.3	33.9	37.3	42.1
133-144	12	39.0	2.3	35.2	39.0	42.9
145-156	13	41.5	2.0	37.6	41.5	45.0

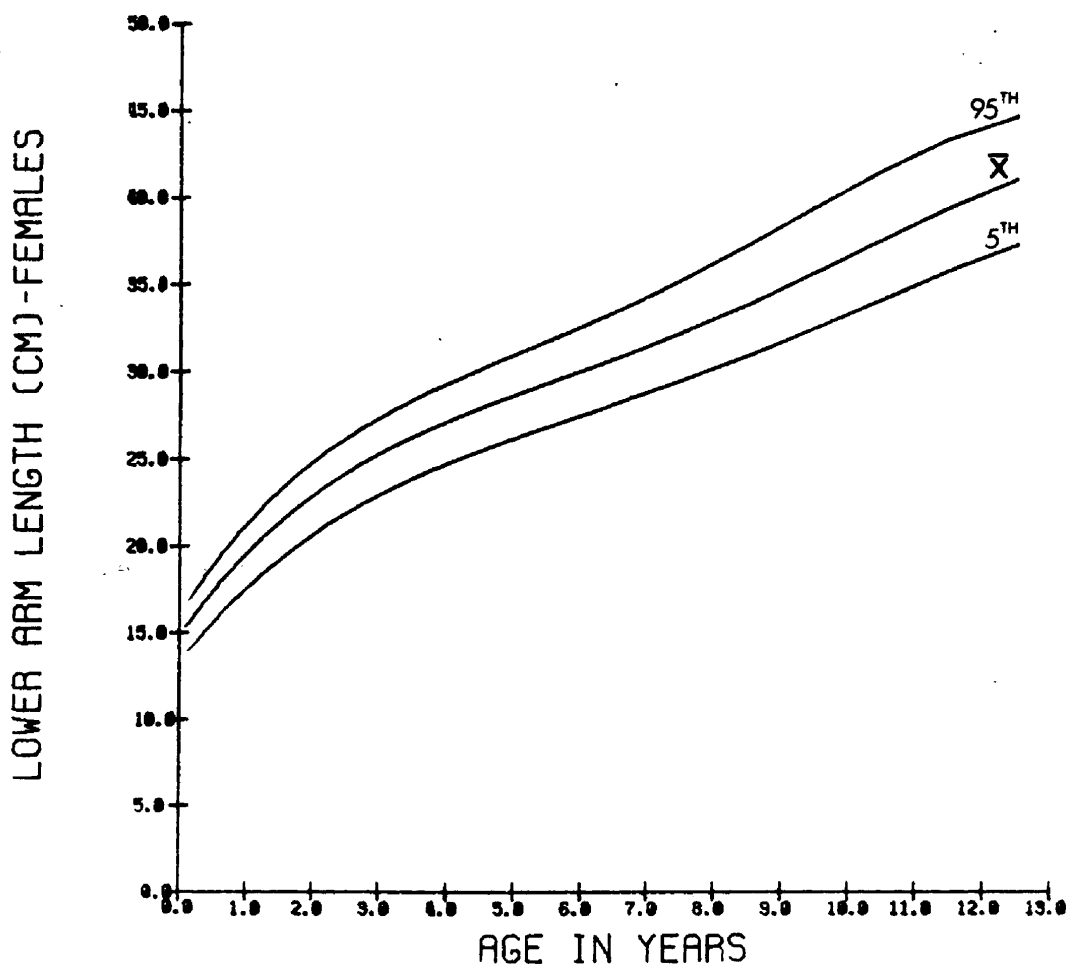

LOWER ARM LENGTH, IN CMS. - MALES

AGE(MO/YRS)	N	MEAN	S.D.	5%	50%	95%
0- 3	76	15.0	1.1	13.0	15.0	16.6
4- 6	44	17.4	1.0	15.7	17.4	19.1
7- 9	24	18.7	0.8	17.6	18.6	19.9
10- 12	17	19.7	0.9	18.6	19.3	22.1
13- 18	28	21.0	1.1	19.2	20.6	22.7
19- 24	42	22.7	1.5	19.4	22.7	25.2
25- 30	33	24.0	1.5	21.3	24.1	26.1
31- 36	49	25.3	1.5	23.4	25.1	28.0
37- 42	128	26.0	1.3	23.8	25.9	28.3
43- 48	120	26.6	1.6	24.3	26.4	29.4
49- 54	165	27.9	1.4	25.7	27.7	30.2
55- 60	155	28.7	1.5	26.1	28.6	31.1
61- 66	124	29.5	1.6	26.8	29.4	32.3
67- 72	91	30.2	1.5	27.5	30.4	32.6
73- 78	77	31.0	1.4	28.7	31.0	33.2
79- 84	77	32.0	1.7	29.2	31.7	34.6
85- 96	135	33.3	1.9	29.9	33.2	36.4
97-108	131	34.5	1.8	31.9	34.6	37.7
109-120	107	36.0	2.0	32.7	35.8	39.2
121-132	98	38.0	1.8	35.2	37.8	41.0
133-144	53	39.4	2.1	35.8	39.1	43.2
145-156	21	40.1	2.5	35.7	39.6	44.0

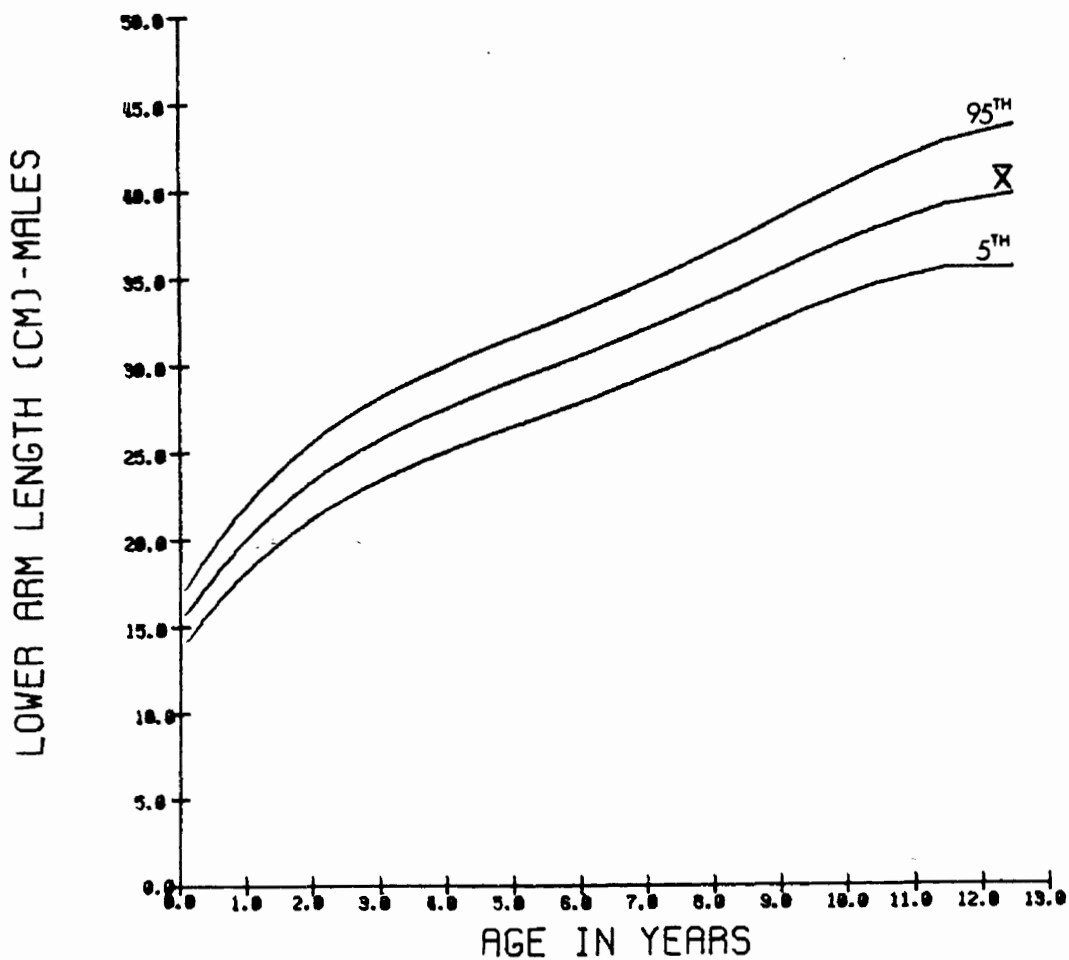

## HAND LENGTH

Device: Automated sliding caliper. Measurements are recorded automatically by computer.

Description: INFANT: Infant lies on back with right hand fully extended, palm up. Measure the parallel distance from the wrist crease to the tip of the third right digit. Paddle-blades firmly contact the two body surfaces for measurement. An assistant is required to assure that the infant is in the correct position.

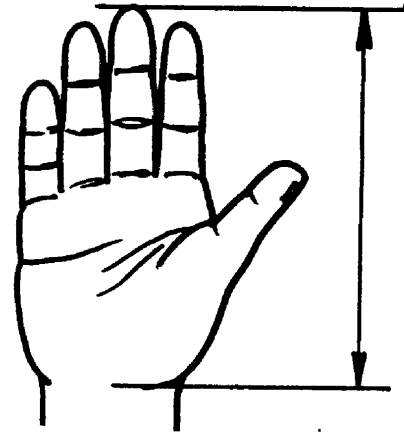

Description: CHILD: Child sits erect, right hand is extended with palm up. Measure the parallel distance from the wrist crease to tip of third digit with an automated sliding caliper. The paddle-blades firmly contact the two body surfaces for measurement.

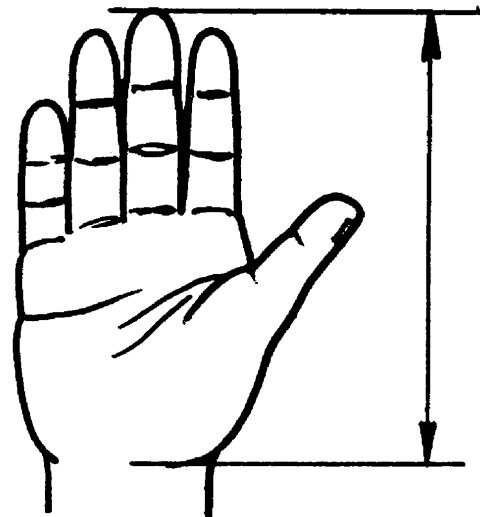
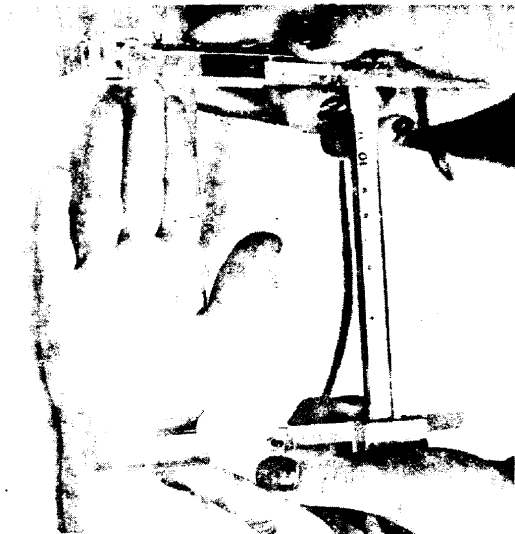

HAND LENGTH, IN CMS. - COMBINED SEXES

AGE (MO/YRS)	N	MEAN	S.D.	5%	50%	95%
0= 3	139	6.8	0.6	5.7	6.7	7.8
4= 6	99	7.6	0.6	6.5	7.5	8.7
7= 9	53	8.3	0.5	7.4	8.3	9.4
10= 12 1	41	8.8	0.5	7.8	8.7	9.5
13= 18	53	9.2	0.6	7.9	9.3	10.1
19= 24 2	71	9.8	0.6	8.9	9.8	10.8
25= 30	66	10.2	0.7	9.2	10.2	11.3
31= 36 3	103	10.6	0.7	9.5	10.6	11.7
37= 42	272	10.9	0.6	9.8	10.9	12.0
43= 48 4	293	11.2	0.6	10.1	11.1	12.3
49= 54	359	11.6	0.6	10.5	11.4	12.7
55= 60 5	329	11.9	0.7	10.7	11.8	13.0
61= 66	246	12.2	0.7	10.9	12.2	13.4
67= 72 6	176	12.5	0.7	11.3	12.5	13.6
73= 78	175	12.8	0.7	11.6	12.7	14.1
79= 84 7	171	13.1	0.7	11.9	13.0	14.5
85= 96 8	283	13.7	0.8	12.3	13.6	15.0
97=108 9	277	14.2	0.8	13.0	14.1	15.9
109=120 10	263	14.6	0.8	13.3	14.5	15.9
121=132 11	206	15.4	0.9	13.9	15.4	17.0
133=144 12	118	15.8	0.9	14.1	15.7	17.2
145=156 13	53	16.5	1.0	14.5	16.4	18.3

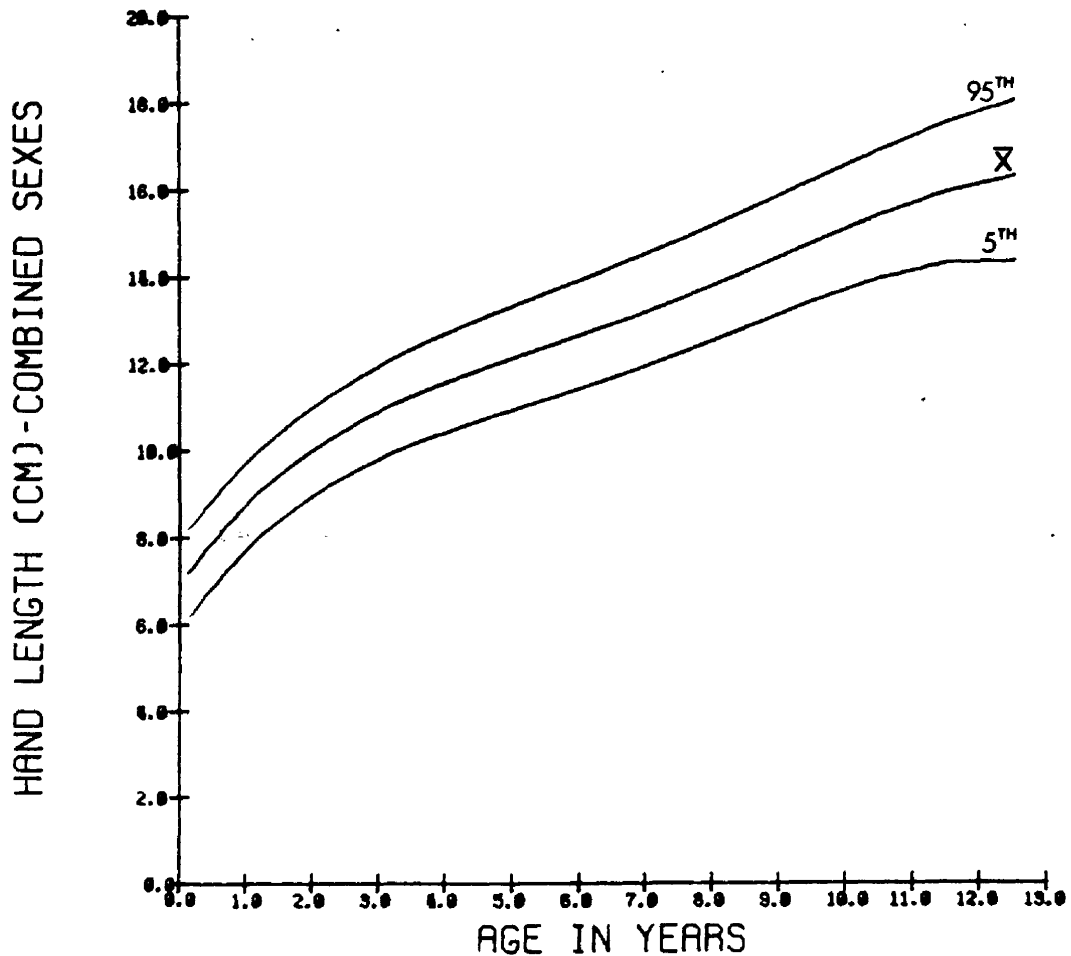



HAND LENGTH, IN CMS. - FEMALES

AGE(MO/YRS)	N	MEAN	S.D.	5%	50%	95%
0= 3	63	6.7	0.6	5.7	6.6	7.7
4= 6	57	7.5	0.6	6.5	7.4	8.5
7= 9	28	8.2	0.5	7.1	8.3	9.0
10= 12	1	8.8	0.5	7.4	8.8	9.4
13= 18	23	9.1	0.6	7.5	9.2	9.9
19= 24	2	9.7	0.7	8.3	9.7	10.9
25= 30	32	10.1	0.7	8.9	10.0	11.3
31= 36	3	10.5	0.7	9.2	10.4	11.5
37= 42	141	10.9	0.6	9.8	10.8	12.0
43= 48	170	11.1	0.6	10.1	11.0	12.1
49= 54	186	11.4	0.6	10.3	11.3	12.6
55= 60	175	11.8	0.6	10.7	11.7	12.9
61= 66	120	12.1	0.7	10.6	12.0	13.3
67= 72	82	12.4	0.7	11.3	12.3	13.5
73= 78	99	12.7	0.8	11.5	12.5	14.2
79= 84	94	13.0	0.7	11.8	12.9	14.3
85= 96	147	13.6	0.8	12.2	13.5	14.8
97=108	144	14.3	0.8	13.0	14.2	15.8
109=120	155	14.5	0.8	13.2	14.5	15.8
121=132	108	15.3	0.9	13.7	15.4	17.0
133=144	63	15.8	0.9	14.2	15.7	17.2
145=156	32	16.8	0.9	15.0	16.7	18.4

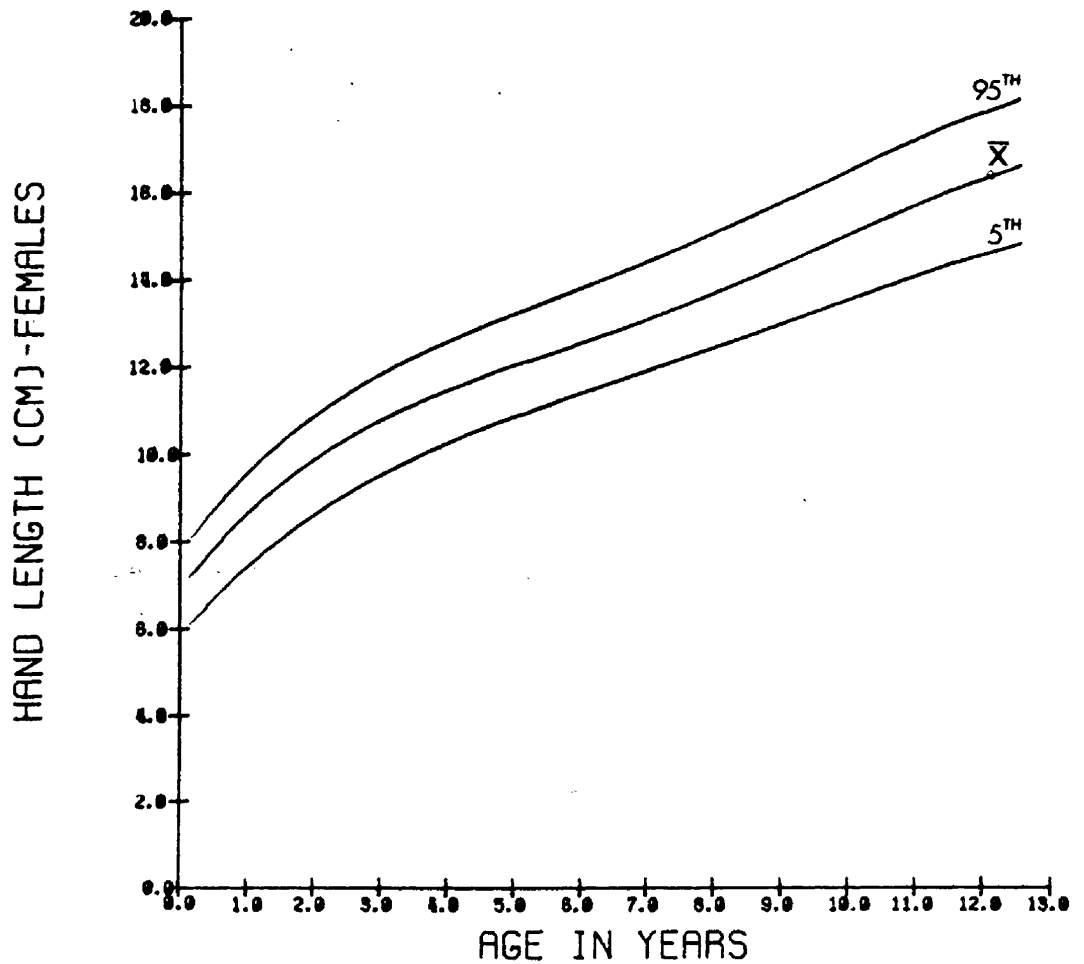

HAND LENGTH, IN CMS, - MALES

AGE(MO/YRS)	N	MEAN	S.D.	5%	50%	95%
0- 3	76	6.8	0.6	5.7	6.7	7.7
4- 6	42	7.8	0.6	6.7	7.7	8.9
7- 9	25	8.5	0.5	7.6	8.4	9.5
10- 12	19	8.8	0.4	8.1	8.7	9.8
13- 18	30	9.3	0.6	7.9	9.3	10.2
19- 24	2	9.9	0.5	9.1	9.9	10.7
25- 30	34	10.3	0.7	9.2	10.2	11.3
31- 36	3	10.8	0.7	9.5	10.8	11.9
37- 42	131	11.0	0.6	9.8	10.9	12.0
43- 48	4	11.3	0.7	10.2	11.2	12.4
49- 54	173	11.7	0.6	10.6	11.6	12.7
55- 60	5	12.0	0.7	10.8	11.9	13.1
61- 66	126	12.3	0.7	11.0	12.2	13.4
67- 72	94	12.6	0.6	11.4	12.6	13.6
73- 78	76	12.9	0.6	11.6	12.8	14.0
79- 84	77	13.2	0.7	11.9	13.1	14.6
85- 96	8	13.8	0.8	12.4	13.7	15.3
97-108	9	14.2	0.8	12.8	14.1	15.9
109-120	10	14.7	0.8	13.5	14.6	16.0
121-132	11	15.4	0.8	14.1	15.4	16.8
133-144	12	15.7	1.0	14.0	15.4	17.2
145-156	13	15.9	1.0	14.3	15.8	17.4

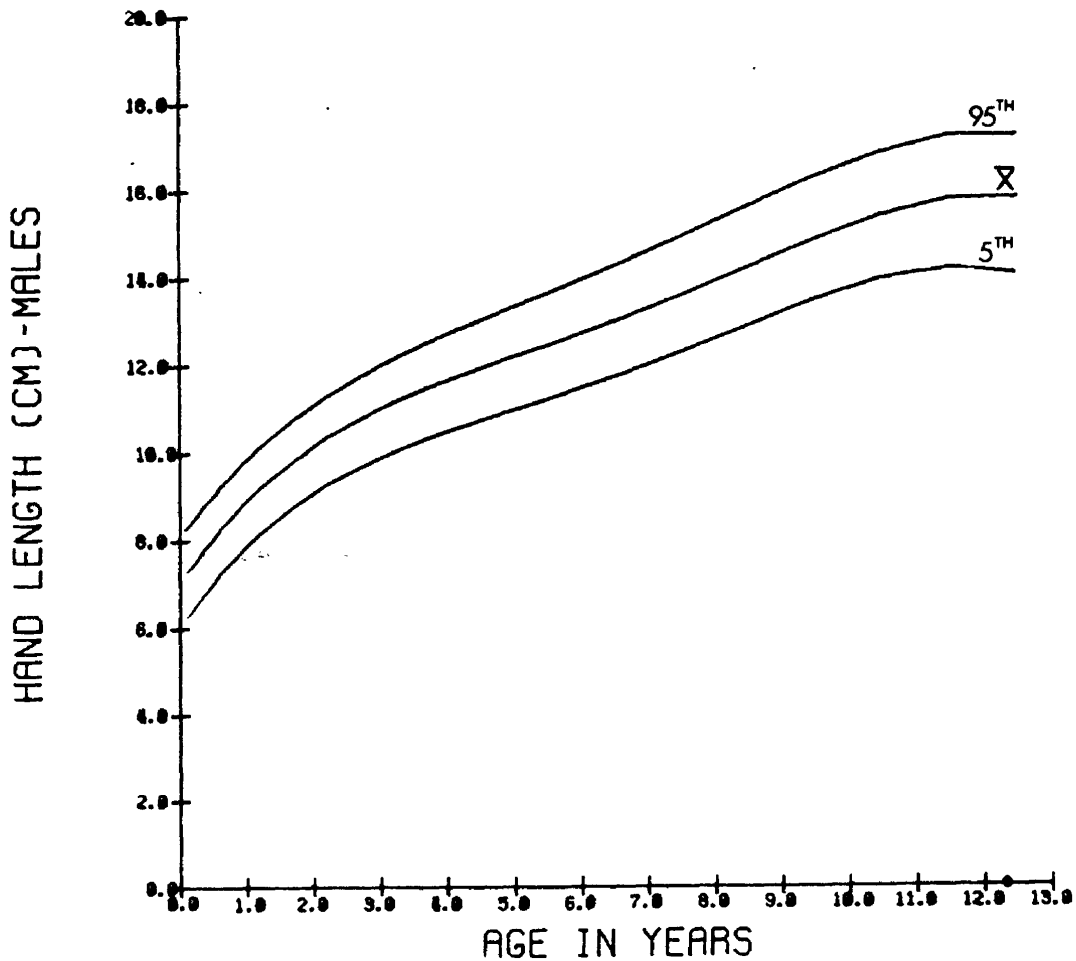

## HAND WIDTH

Device: Automated sliding caliper equipped with pressure transducer in paddle blade. Measurements are recorded automatically by computer at fixed pressure values.

Description: INFANT: Infant lies on back with right hand fully extended, palm up, thumb abducted from hand. Measure the maximum width across the metacarpal-phalangeal with an automated sliding caliper. The paddle-blades firmly contact the two body surfaces for measurement. An assistant is required to assure that the infant is in the correct position.

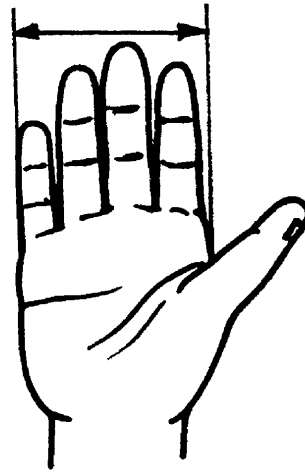

Description: CHILD: Child sits erect, hand and fingers extended with palm up, thumb abducted from hand. Measure the maximum width across the metacarpal-phalangeal joints II and V with an automated sliding caliper. The paddle blades firmly contact the two body surfaces for measurement.

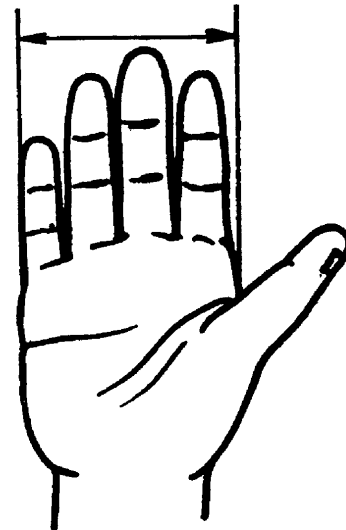

HAND WIDTH, IN CMS. - COMBINED SEXES

AGE(MO/YRS)	N	MEAN	S.D.	5%	50%	95%
0= 3	134	3.6	0.5	2.6	3.5	4.5
4= 6	91	4.1	0.4	3.3	4.1	4.7
7= 9	49	4.4	0.4	3.5	4.4	5.2
10= 12 1	37	4.4	0.3	3.8	4.4	5.1
13= 18	52	4.6	0.3	3.9	4.6	5.2
19= 24 2	68	4.9	0.4	4.2	4.8	5.5
25= 30	63	5.0	0.4	4.2	5.0	5.6
31= 36 3	103	5.1	0.4	4.3	5.0	5.7
37= 42	272	5.1	0.4	4.4	5.1	5.8
43= 48 4	293	5.2	0.4	4.5	5.2	5.9
49= 54	355	5.4	0.4	4.7	5.4	6.0
55= 60 5	326	5.5	0.4	4.8	5.5	6.2
61= 66	244	5.7	0.4	4.9	5.7	6.3
67= 72 6	175	5.8	0.4	5.0	5.8	6.3
73= 78	173	5.9	0.4	5.2	5.9	6.5
79= 84 7	171	6.1	0.4	5.4	6.0	6.7
85= 96 8	277	6.3	0.4	5.5	6.2	7.0
97=108 9	274	6.5	0.4	5.7	6.5	7.2
109=120 10	247	6.7	0.4	5.9	6.6	7.3
121=132 11	201	7.0	0.4	6.7	6.9	7.7
133=144 12	115	7.3	0.4	6.5	7.2	7.9
145=156 13	53	7.5	0.4	6.8	7.5	8.2

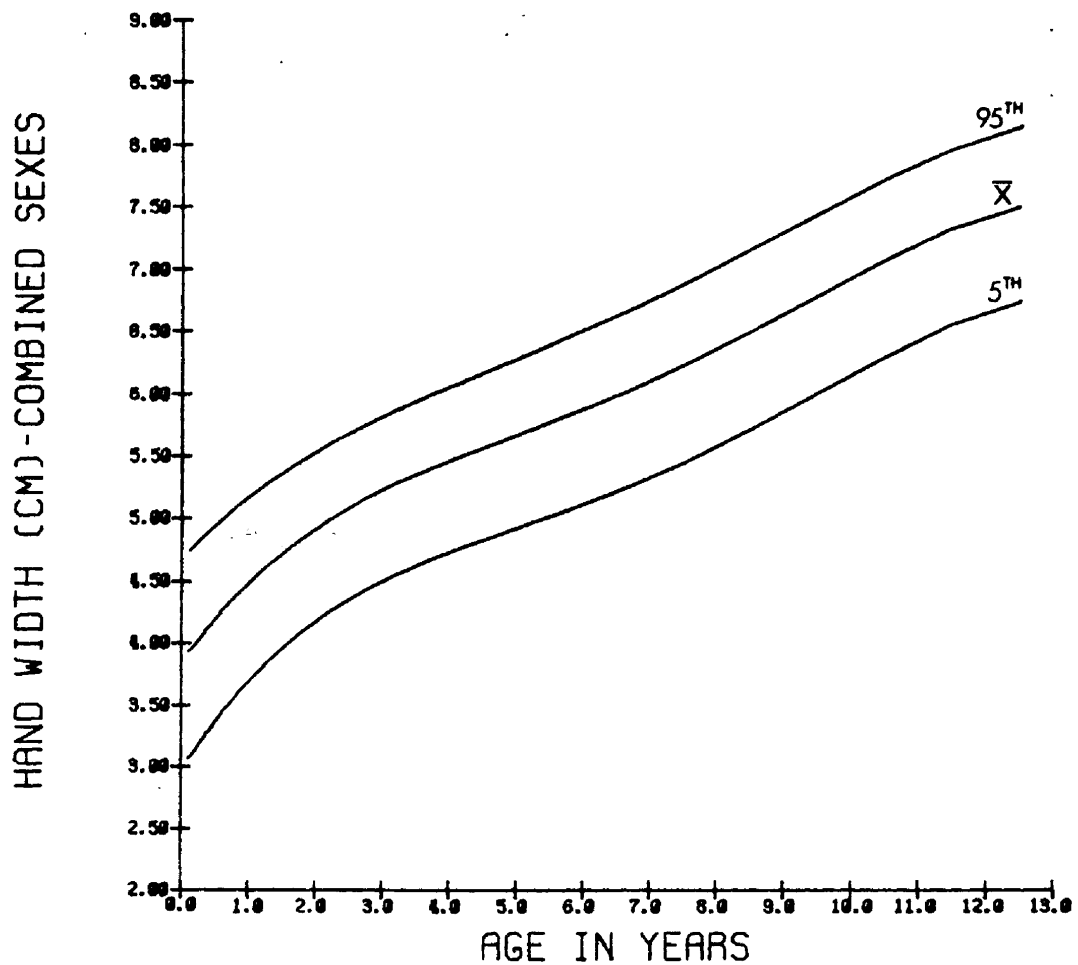

HAND WIDTH, IN CMS. - FEMALES

AGE(MO/YRS)	N	MEAN	S.D.	5%	50%	95%
0= 3	61	3.5	0.5	2.7	3.5	4.5
4= 6	51	4.0	0.4	3.2	4.0	4.6
7= 9	27	4.4	0.4	3.4	4.3	5.0
10= 12 1	21	4.3	0.3	3.9	4.1	4.8
13= 18	22	4.5	0.3	3.9	4.4	5.0
19= 24 2	29	4.7	0.3	4.0	4.6	5.3
25= 30	30	5.0	0.3	4.2	4.9	5.5
31= 36 3	55	5.0	0.3	4.3	4.9	5.5
37= 42	141	5.1	0.4	4.4	5.0	5.8
43= 48 4	170	5.2	0.4	4.5	5.1	5.8
49= 54	184	5.3	0.4	4.5	5.3	5.9
55= 60 5	173	5.5	0.4	4.7	5.4	6.1
61= 66	120	5.6	0.4	4.8	5.6	6.3
67= 72 6	82	5.7	0.3	5.1	5.7	6.2
73= 78	99	5.9	0.3	5.2	5.8	6.5
79= 84 7	95	6.0	0.4	5.3	6.0	6.7
85= 96 8	144	6.2	0.4	5.4	6.1	6.9
97=108 9	143	6.4	0.4	5.8	6.4	7.1
109=120 10	144	6.6	0.4	5.9	6.5	7.3
121=132 11	103	6.9	0.4	6.1	6.8	7.6
133=144 12	60	7.2	0.4	6.5	7.1	7.7
145=156 13	32	7.6	0.4	7.0	7.6	8.2

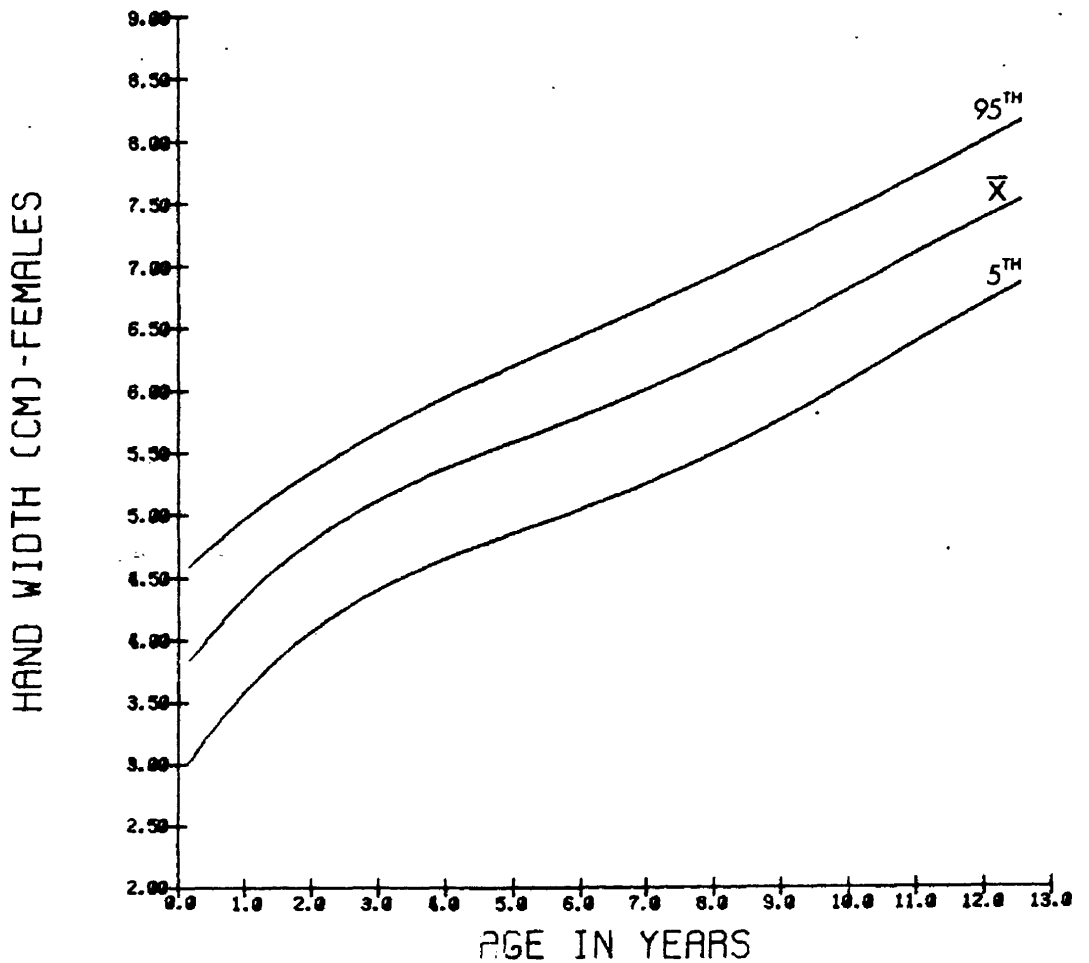

HAND WIDTH, IN CMS. - MALES

AGE(MO/YRS)	N	MEAN	S.D.	5%	50%	95%
0= 3	73	3.7	0.5	2.5	3.6	4.5
4= 6	40	4.2	0.4	3.4	4.2	5.0
7= 9	22	4.5	0.4	3.5	4.5	5.1
10= 12 1	16	4.6	0.4	3.8	4.6	5.2
13= 18	30	4.7	0.3	3.8	4.7	5.2
19= 24 2	39	5.0	0.3	4.4	4.9	5.7
25= 30	33	5.1	0.4	4.2	5.0	5.7
31= 36 3	48	5.1	0.4	4.2	5.2	5.8
37= 42	131	5.2	0.3	4.5	5.2	5.8
43= 48 4	123	5.3	0.4	4.6	5.3	6.0
49= 54	171	5.5	0.3	4.9	5.5	6.1
55= 60 5	153	5.6	0.3	5.0	5.5	6.2
61= 66	124	5.8	0.4	5.0	5.7	6.3
67= 72 6	93	5.8	0.4	5.0	5.9	6.3
73= 78	74	6.0	0.4	5.2	6.0	6.8
79= 84 7	76	6.2	0.4	5.4	6.2	6.9
85= 96 8	133	6.4	0.4	5.6	6.4	7.1
97=108 9	131	6.6	0.4	5.7	6.5	7.4
109=120 10	103	6.7	0.3	6.0	6.7	7.3
121=132 11	98	7.1	0.4	6.3	7.0	7.8
133=144 12	55	7.4	0.4	6.6	7.3	7.9
145=156 13	21	7.5	0.4	6.7	7.5	8.0

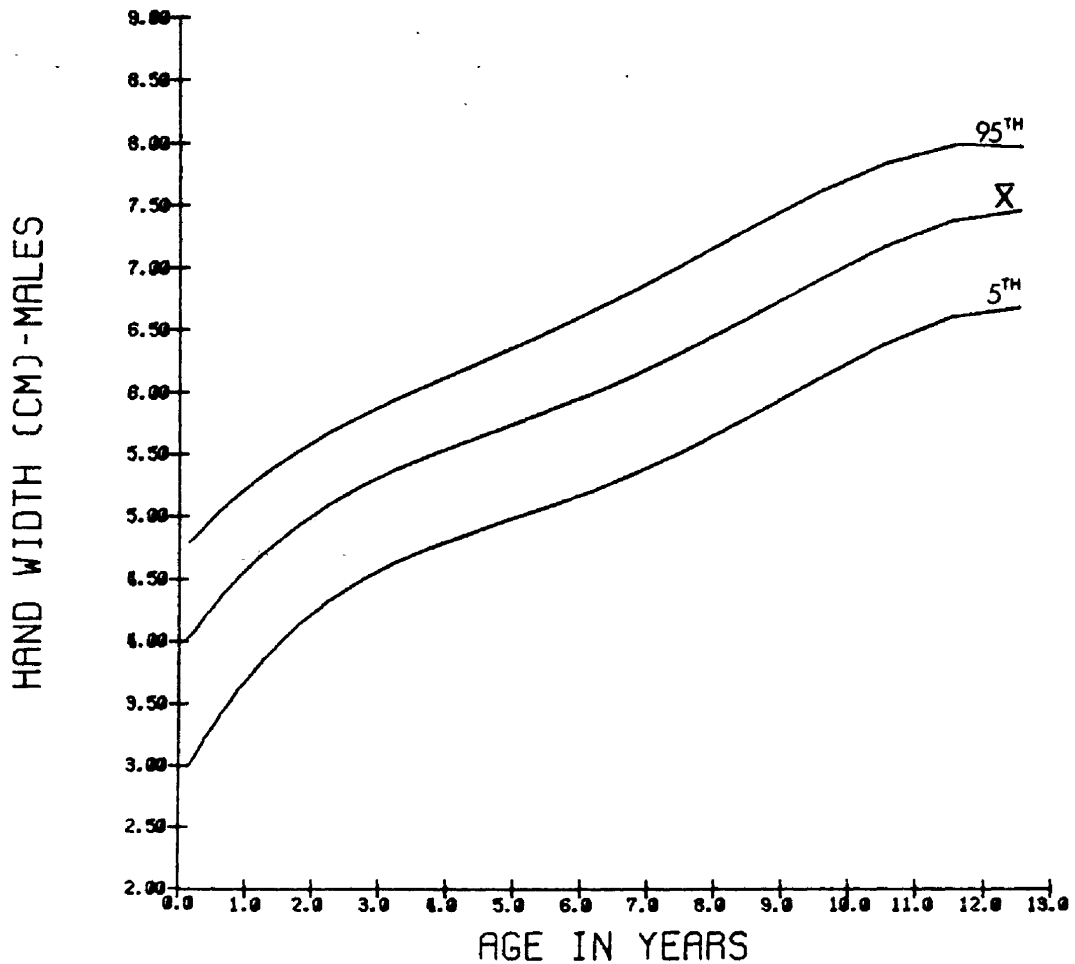

## FOOT LENGTH

Device: Automated sliding caliper or anthropometer. Measurements are recorded automatically by computer.

Description: INFANT: Infant lies on back. Measure the parallel distance from the heel to the foremost toe of the right foot with an automated sliding caliper. The paddle-blades firmly contact the two body surfaces for measurement. An assistant is required to assure that the infant is in the correct position.

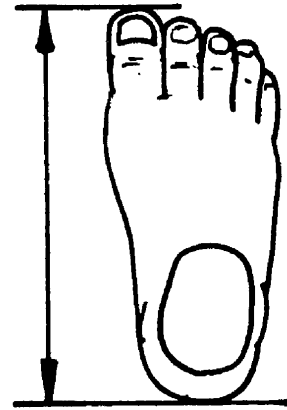
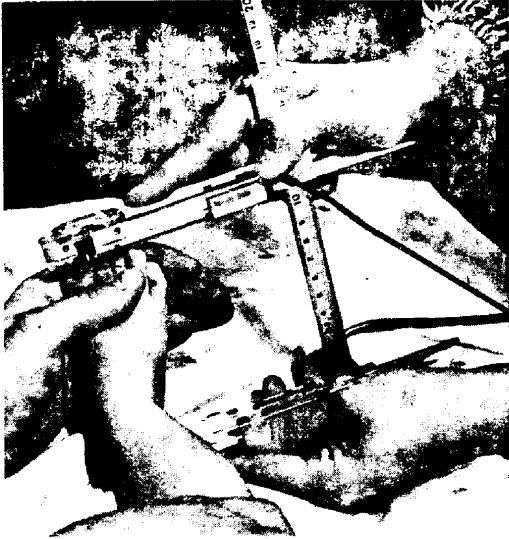

Description: CHILD: Child sits erect, feet resting on platform for 90° knee flexion, arms resting at side. Measure the parallel distance from heel to the foremeost toe of the right foot with an automated anthropometer. The paddle-blades firmly contact the two body surfaces for measurement.

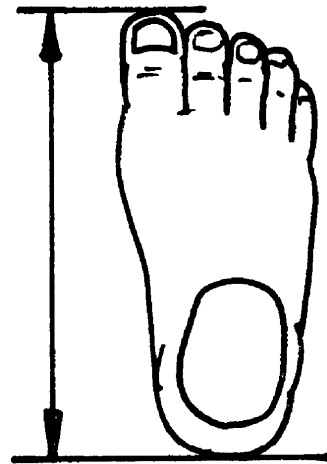

FOOT LENGTH, IN CMS. - COMBINED SEXES

AGE (MO/YRS)	N	MEAN	S.D.	5%	50%	95%
0- 3	138	8.2	0.6	7.0	8.1	9.2
4- 6	100	9.4	0.7	8.2	9.3	10.6
7- 9	52	10.4	0.6	9.5	10.3	11.4
10- 12	1	41	10.9	0.8	9.3	11.0
13- 18	55	11.7	0.8	10.4	11.6	13.3
19- 24	2	72	12.8	0.8	11.4	12.8
25- 30	64	13.7	0.7	12.4	13.6	14.9
31- 36	3	104	14.2	0.9	12.6	14.1
37- 42	268	14.8	0.8	13.3	14.7	16.2
43- 48	4	292	15.1	0.9	13.7	15.0
49- 54	354	15.7	0.9	14.1	15.6	17.2
55- 60	5	325	16.2	1.0	14.5	16.1
61- 66	242	16.7	1.1	14.8	16.6	18.5
67- 72	6	176	17.2	1.0	15.1	17.2
73- 78	175	17.6	1.0	15.9	17.5	19.3
79- 84	7	174	18.1	1.0	16.4	18.0
85- 96	8	279	18.8	1.1	17.0	18.8
97-108	9	277	19.7	1.1	17.9	19.7
109-120	10	258	20.2	1.1	18.4	20.1
121-132	11	206	21.2	1.2	19.3	21.2
133-144	12	115	21.9	1.2	19.9	21.8
145-156	13	52	22.6	1.1	20.4	22.5

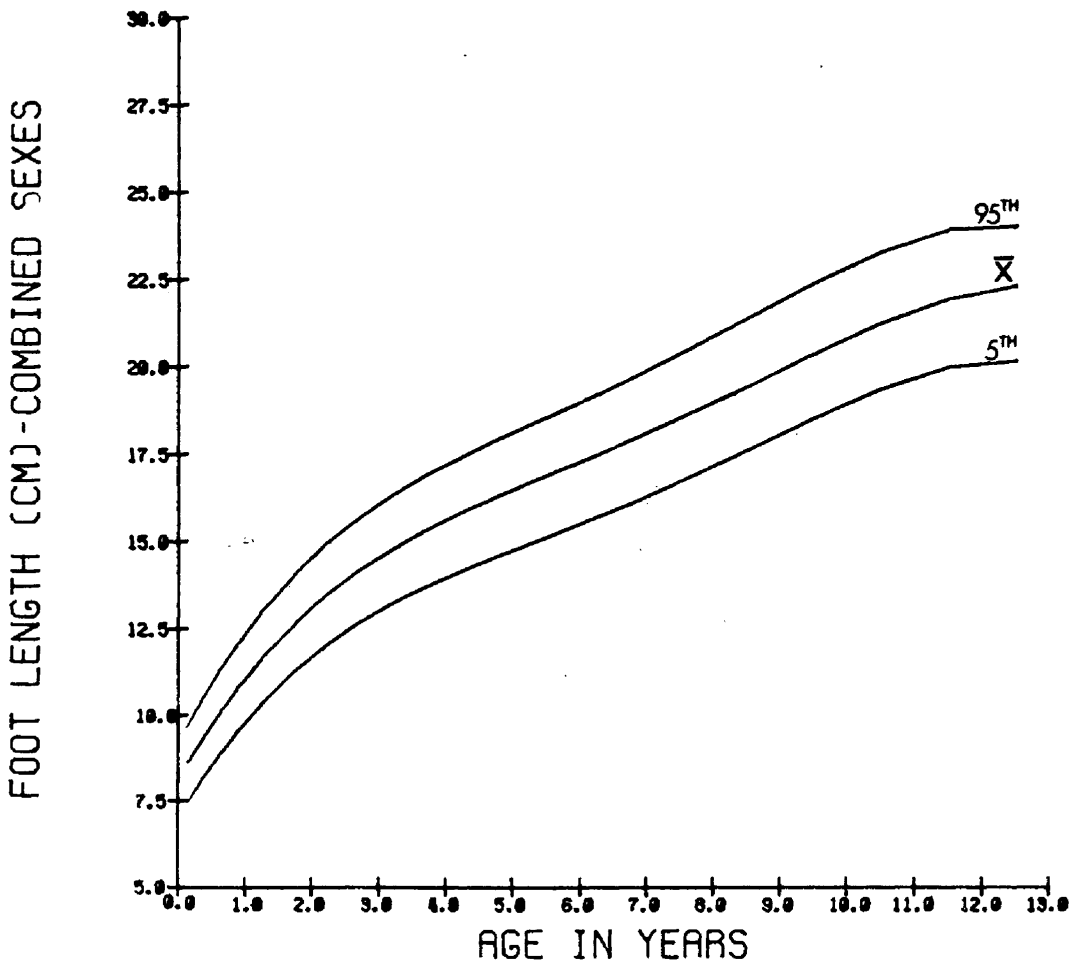



FOOT LENGTH, IN CMS. - FEMALES

AGE(MO/YRS)	N	MEAN	S.D.	5%	50%	95%
0- 3	62	8.1	0.6	7.0	8.0	9.2
4- 6	57	9.2	0.6	8.1	9.2	10.2
7- 9	28	10.3	0.4	9.6	10.3	11.0
10- 12	1	22	10.8	0.8	9.2	11.0
13- 18	24	11.4	0.7	9.8	11.4	12.3
19- 24	2	30	12.6	0.8	10.6	12.6
25- 30	30	13.5	0.6	12.4	13.5	14.4
31- 36	3	55	14.0	0.9	12.5	14.0
37- 42	140	14.6	0.8	13.1	14.6	16.2
43- 48	4	170	15.1	0.8	13.7	15.0
49- 54	183	15.5	0.8	14.0	15.4	16.8
55- 60	5	174	16.0	1.0	14.4	16.0
61- 66	120	16.6	1.0	14.8	16.5	18.5
67- 72	6	82	17.0	1.0	15.1	17.0
73- 78	99	17.5	1.0	15.9	17.4	19.4
79- 84	7	96	17.9	0.9	16.1	17.9
85- 96	8	147	18.6	1.1	16.8	18.7
97-108	9	144	19.8	1.1	18.0	19.7
109-120	10	151	20.1	1.1	18.4	20.0
121-132	11	106	21.0	1.2	19.2	20.9
133-144	12	63	21.7	1.1	19.8	21.5
145-156	13	32	22.5	1.0	20.3	22.5

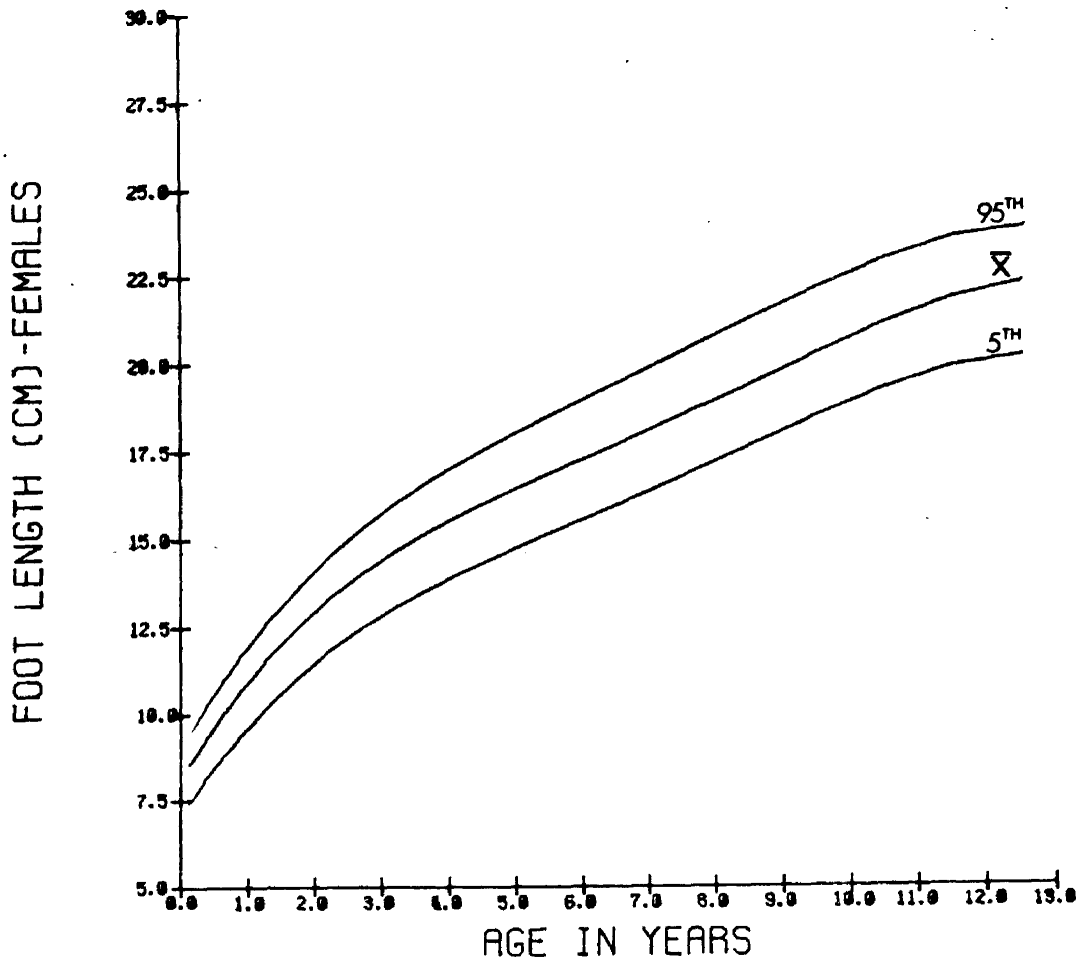

FOOT LENGTH, IN CMS. - MALES

AGE(MO/YRS)	N	MEAN	S.D.	5%	50%	95%
0- 3	76	8.2	0.6	7.1	8.2	9.2
4- 6	43	9.7	0.8	8.3	9.5	10.9
7- 9	24	10.5	0.7	9.4	10.2	11.6
10- 12	1	11.1	0.8	9.5	10.9	12.9
13- 18	31	12.0	0.9	10.3	11.6	13.4
19- 24	2	13.0	0.8	11.5	12.9	14.6
25- 30	34	13.9	0.8	12.3	13.9	15.2
31- 36	3	14.4	0.9	12.9	14.4	15.9
37- 42	128	14.9	0.8	13.3	15.0	16.3
43- 48	4	15.2	1.0	13.7	15.1	16.7
49- 54	171	15.9	0.8	14.6	15.8	17.3
55- 60	5	16.3	1.0	14.8	16.2	18.1
61- 66	122	16.8	1.1	14.8	16.7	18.3
67- 72	6	17.3	1.0	15.1	17.3	18.8
73- 78	76	17.7	0.9	15.9	17.7	19.2
79- 84	7	18.3	1.0	16.6	18.2	20.0
85- 96	8	19.0	1.1	17.1	19.0	20.8
97-108	9	19.7	1.1	17.9	19.7	21.5
109-120	10	20.4	1.2	18.3	20.2	22.5
121-132	11	21.5	1.1	19.7	21.4	23.4
133-144	12	22.2	1.4	19.9	22.0	24.5
145-156	13	22.6	1.2	20.6	22.4	25.4

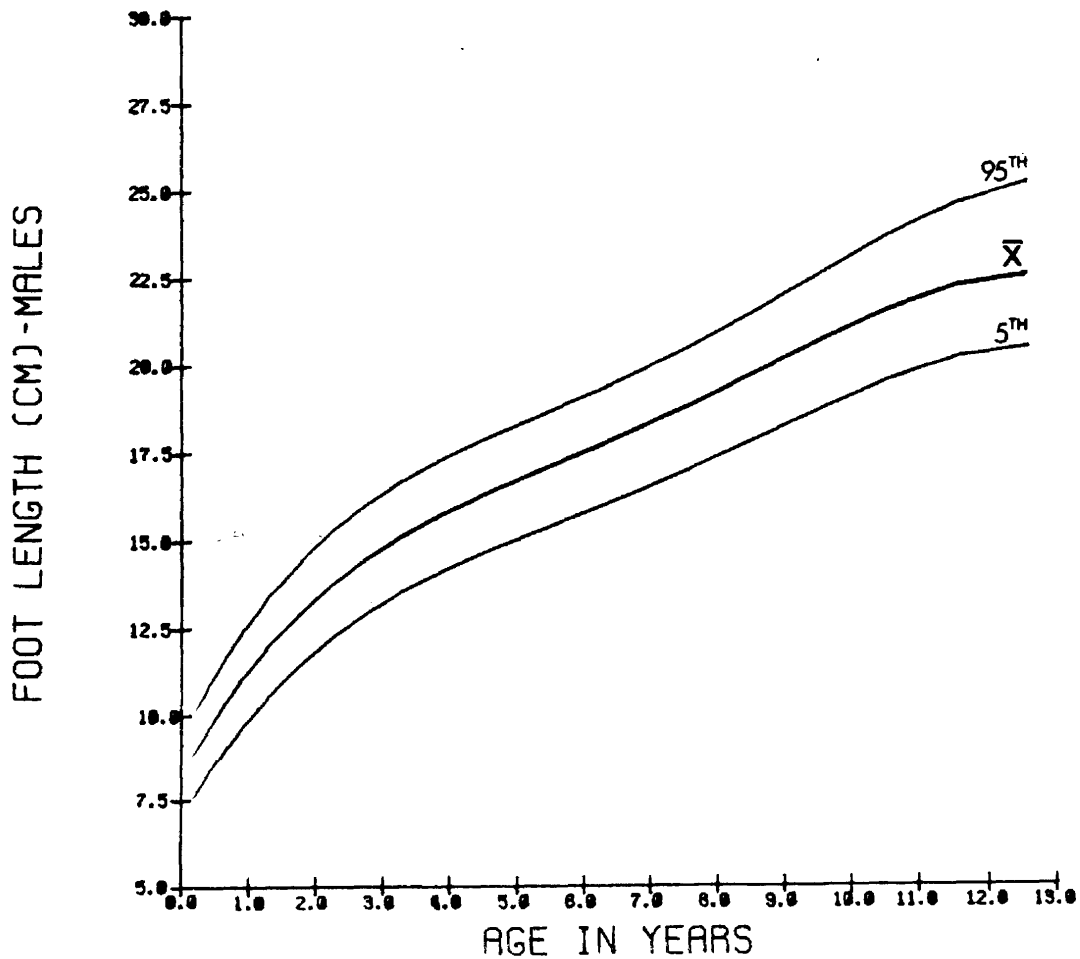

## FOOT BREADTH

Device: Automated sliding caliper equipped with pressure transducer in paddle blade. Measurements are recorded automatically by computer at fixed pressure values.

Description: INFANT: Infant lies on back. Measure the maximum breadth across the ball of the right foot with an automated sliding caliper. The paddle-blades firmly contact the two body surfaces for measurement. An assistant is required to assure that the infant is in the correct position.



Description: CHILD: Child sits erect, arms resting at side. Measure the maximum breadth across the ball of the right foot with an automated sliding caliper. Pressure is applied momentarily with the pressure transducer paddle-blade on the lateral surface of the foot.



FOOT BREADTH, IN CMS. - COMBINED SEXES

AGE(MO/YRS)	N	MEAN	S.D.	5%	50%	95%
0= 3	136	3.4	0.4	2.7	3.4	4.1
4= 6	93	4.0	0.5	3.2	3.9	4.9
7= 9	52	4.4	0.4	3.4	4.3	5.2
10= 12 1	40	4.6	0.4	3.8	4.5	5.2
13= 18	54	4.8	0.4	4.0	4.7	5.5
19= 24 2	66	5.2	0.4	4.5	5.1	6.0
25= 30	61	5.4	0.4	4.7	5.4	5.9
31= 36 3	101	5.5	0.4	4.7	5.4	6.2
37= 42	268	5.6	0.4	4.8	5.6	6.2
43= 48 4	285	5.7	0.4	4.8	5.7	6.4
49= 54	352	5.9	0.4	5.1	5.8	6.6
55= 60 5	318	6.0	0.5	5.1	6.0	6.8
61= 66	241	6.2	0.5	5.4	6.2	7.0
67= 72 6	175	6.3	0.5	5.4	6.3	7.1
73= 78	173	6.5	0.5	5.6	6.5	7.3
79= 84 7	166	6.7	0.4	5.9	6.6	7.5
85= 96 8	273	6.9	0.5	6.1	6.8	7.7
97=108 9	275	7.2	0.5	6.3	7.1	7.9
109=120 10	241	7.4	0.5	6.4	7.3	8.2
121=132 11	199	7.7	0.5	6.8	7.7	8.8
133=144 12	110	8.0	0.5	7.1	8.0	8.8
145=156 13	51	8.4	0.5	7.4	8.2	9.3

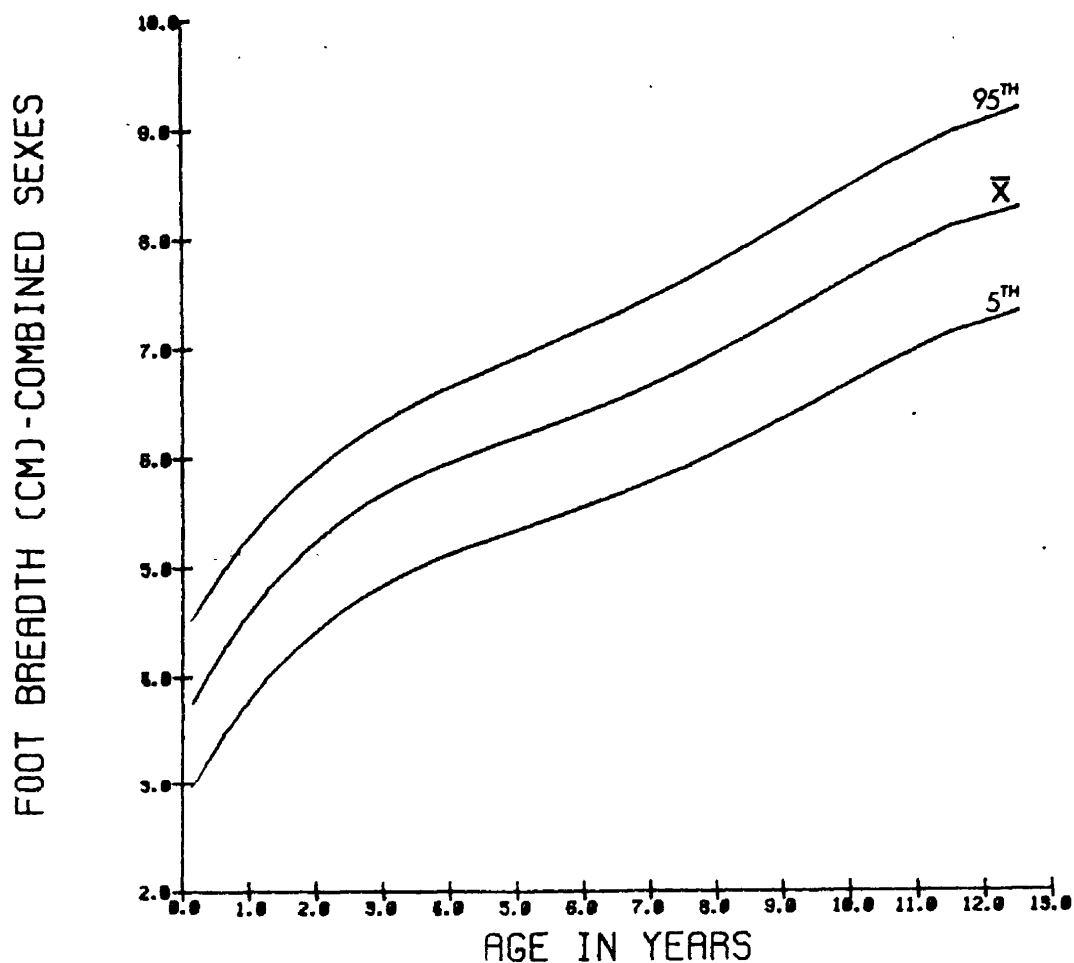

FOOT BREADTH, IN CMS. - FEMALES

AGE (MO/YRS)	N	MEAN	S.D.	5%	50%	95%	
0- 3	62	3.4	0.4	2.7	3.2	4.1	
4- 6	52	3.9	0.4	3.0	3.9	4.6	
7- 9	29	4.4	0.4	3.5	4.3	5.1	
10- 12	1	22	4.4	0.4	3.7	4.4	5.0
13- 18	23	4.7	0.3	4.1	4.7	5.3	
19- 24	2	27	5.0	0.4	4.1	4.9	5.6
25- 30	29	5.4	0.3	4.4	5.3	5.8	
31- 36	3	53	5.4	0.5	4.5	5.3	6.2
37- 42	140	5.6	0.4	4.7	5.6	6.2	
43- 48	4	162	5.6	0.4	4.8	5.5	6.4
49- 54	183	5.8	0.4	5.0	5.7	6.5	
55- 60	5	168	5.9	0.4	5.0	5.8	6.6
61- 66	118	6.2	0.5	5.2	6.1	6.9	
67- 72	6	82	6.2	0.4	5.4	6.2	6.9
73- 78	97	6.4	0.4	5.4	6.4	7.2	
79- 84	7	93	6.6	0.4	5.9	6.5	7.4
85- 96	8	142	6.8	0.4	6.0	6.7	7.6
97-100	9	142	7.1	0.5	6.2	7.1	7.9
109-120	10	141	7.3	0.5	6.3	7.3	8.1
121-132	11	102	7.6	0.5	6.7	7.6	8.5
133-144	12	60	8.0	0.5	7.1	7.9	8.8
145-156	13	32	8.3	0.5	7.4	8.1	9.2

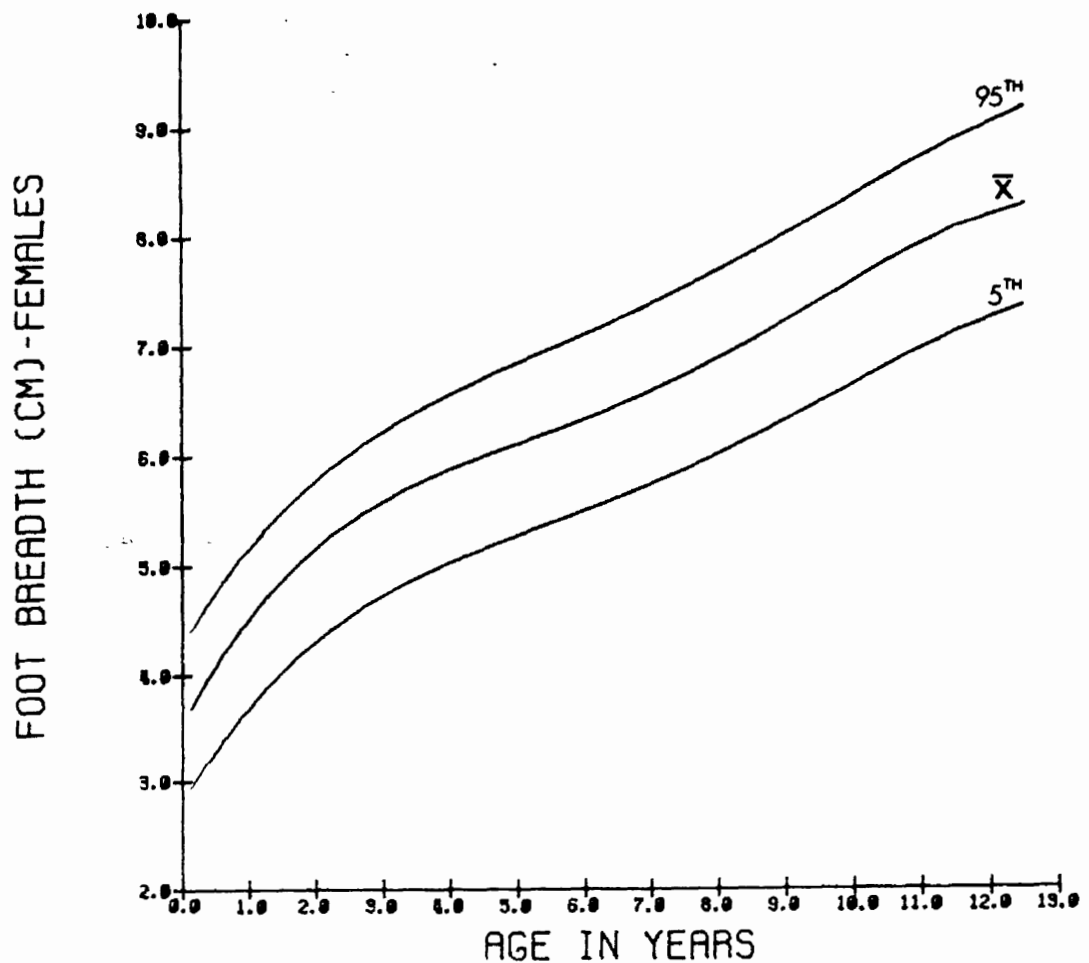

FOOT BREADTH, IN CMS, - MALES

AGE (MO/YRS)	N	MEAN	S.D.	5%	50%	95%	
0- 3	74	3.5	0.4	2.7	3.4	4.1	
4- 6	41	4.2	0.5	3.5	4.0	5.0	
7- 9	23	4.4	0.4	3.3	4.3	5.1	
10- 12	1	18	4.7	0.4	4.1	4.6	5.6
13- 18	31	4.9	0.4	4.0	4.9	5.5	
19- 24	2	39	5.4	0.4	4.6	5.3	6.1
25- 30	32	5.4	0.4	4.5	5.4	6.0	
31- 36	3	48	5.6	0.3	4.9	5.6	6.1
37- 42	128	5.7	0.4	5.0	5.7	6.3	
43- 48	4	123	5.8	0.4	4.9	5.8	6.5
49- 54	169	6.0	0.4	5.2	5.9	6.7	
55- 60	5	150	6.1	0.4	5.3	6.1	6.9
61- 66	123	6.3	0.5	5.4	6.2	7.0	
67- 72	6	93	6.4	0.5	5.6	6.4	7.2
73- 78	76	6.6	0.5	5.6	6.5	7.5	
79- 84	7	73	6.9	0.4	6.2	6.8	7.6
85- 96	8	131	7.0	0.5	6.2	6.9	7.9
97-108	9	133	7.2	0.5	6.3	7.2	8.1
109-120	10	100	7.4	0.5	6.5	7.4	8.2
121-132	11	97	7.9	0.5	6.8	7.8	8.9
133-144	12	50	8.0	0.5	6.9	8.0	8.8
145-156	13	19	8.4	0.5	7.4	8.3	9.4

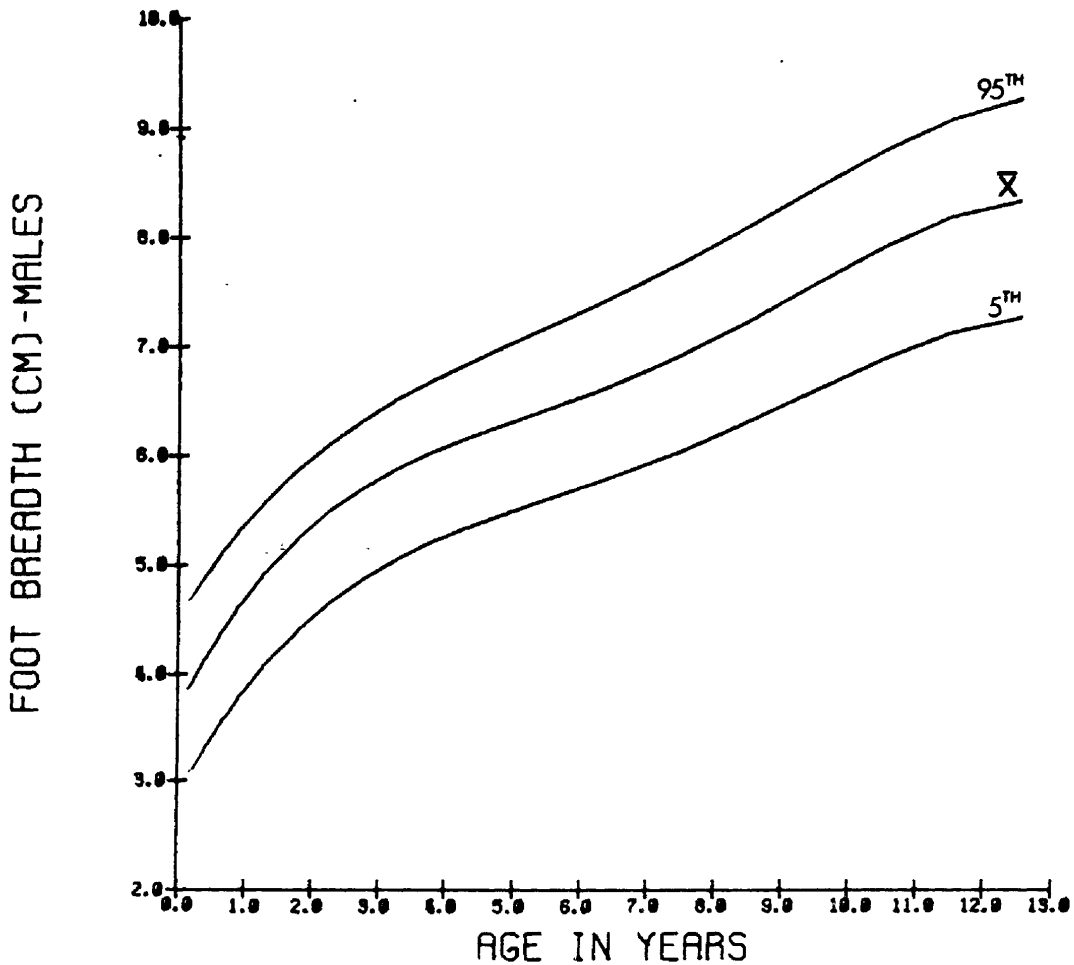

## LITTLE FINGER LENGTH

Device: Automated sliding caliper. Measurements are recorded automatically by computer.

Description: INFANT: Infant lies on back with right hand and fingers extended, palm up. Measure the parallel distance from the skin crease at the base of the fifth right digit to the tip of the fifth digit with an automated sliding caliper. The paddle-blade firmly contacts the two body surfaces for measurement. An assistant is required to assure that the infant is in the correct position.

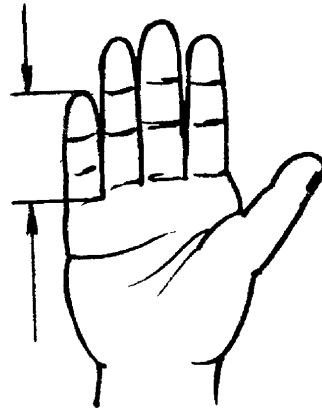
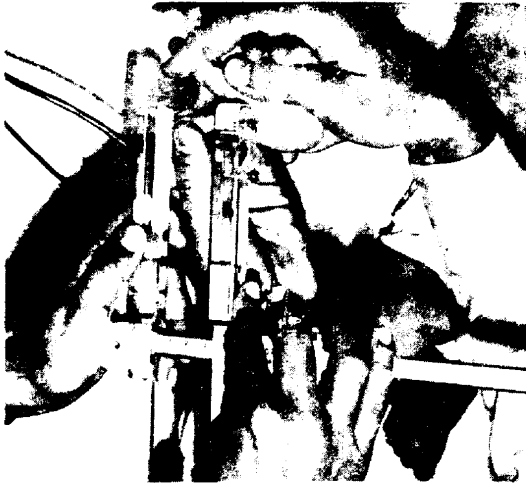

Description: CHILD: Hand and fingers are extended palm up. Measure the parallel distance from the skin crease at the base of the fifth digit to the tip of the fifth digit with an automated sliding caliper. The paddle-blades firmly contact the two body surfaces for measurement.

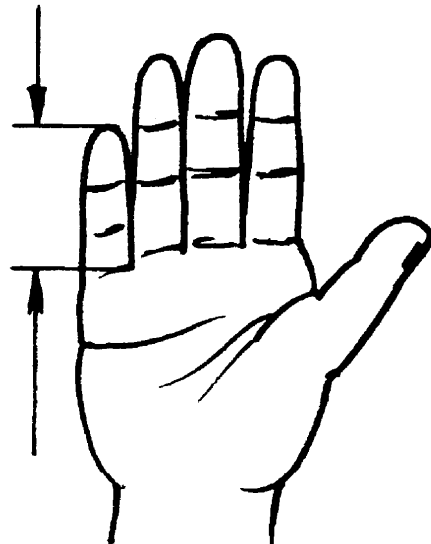

LITTLE FINGER LENGTH, IN CMS. - COMBINED SEXES

AGE (MO/YRS)	N	MEAN	S.D.	5%	50%	95%
0= 3	138	2.4	0.4	1.7	2.3	3.4
4= 6	99	2.7	0.4	2.0	2.5	3.5
7= 9	51	3.0	0.5	2.1	2.8	4.0
10= 12 1	39	2.9	0.3	2.2	2.8	3.6
13= 18	53	3.0	0.3	2.5	2.9	3.4
19= 24 2	70	3.1	0.3	2.5	3.1	3.4
25= 30	65	3.3	0.4	2.6	3.2	4.0
31= 36 3	102	3.3	0.3	2.7	3.3	3.8
37= 42	272	3.3	0.3	2.7	3.3	3.9
43= 48 4	293	3.4	0.3	2.8	3.3	4.0
49= 54	359	3.5	0.3	2.9	3.4	4.1
55= 60 5	330	3.6	0.3	2.9	3.5	4.2
61= 66	246	3.8	0.4	3.0	3.7	4.4
67= 72 6	176	3.9	0.4	3.1	3.8	4.5
73= 78	175	4.0	0.4	3.3	4.0	4.6
79= 84 7	172	4.1	0.4	3.3	4.0	4.7
85= 96 8	282	4.3	0.4	3.5	4.2	5.0
97=108 9	278	4.5	0.4	3.7	4.4	5.3
109=120 10	261	4.6	0.4	3.9	4.6	5.3
121=132 11	206	4.9	0.4	4.1	4.8	5.6
133=144 12	117	5.0	0.4	4.3	5.0	5.7
145=156 13	53	5.3	0.4	4.6	5.2	6.0

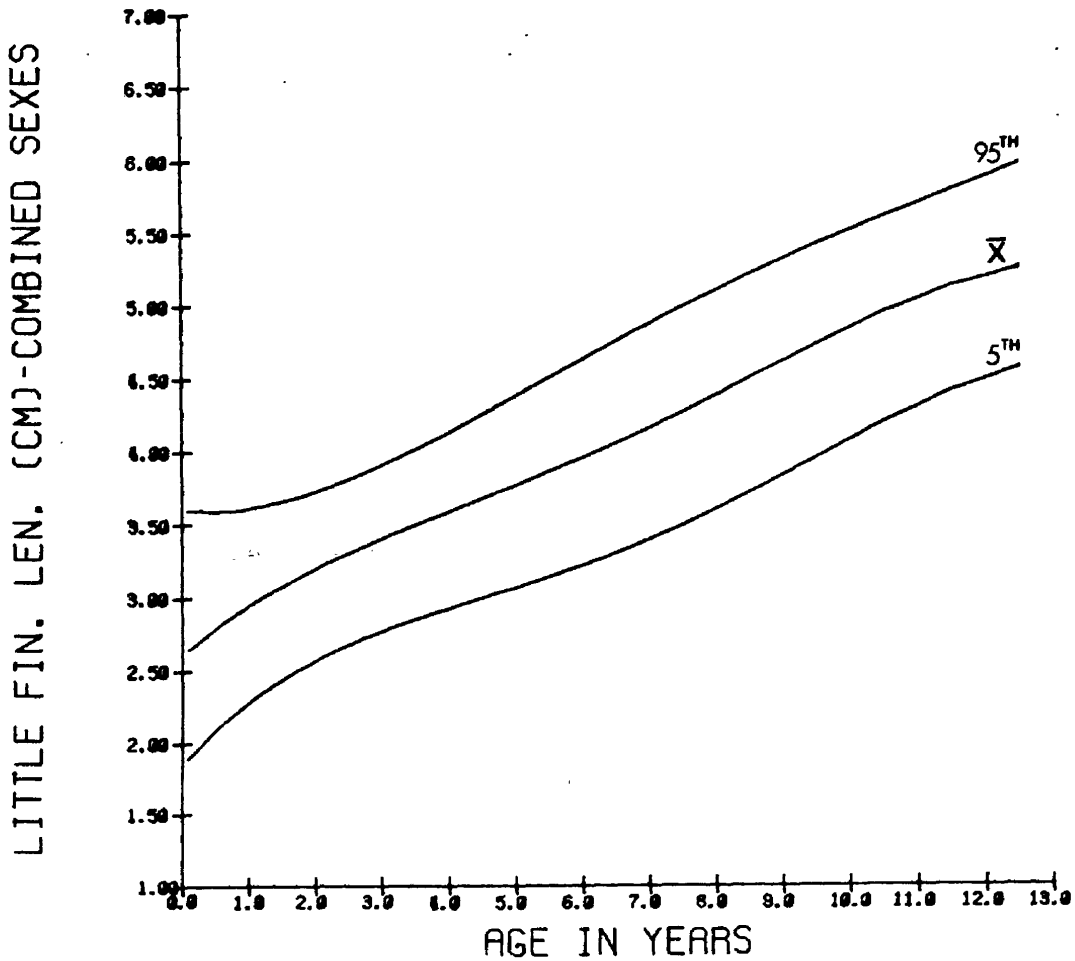



LITTLE FINGER LENGTH, IN CMS. - FEMALES

AGE (MO/YRS)	N	MEAN	S.D.	5%	50%	95%	
0- 3	62	2.4	0.4	1.7	2.3	3.4	
4- 6	56	2.6	0.4	1.8	2.5	3.4	
7- 9	27	2.9	0.4	2.1	2.8	3.9	
10- 12	1	21	3.0	0.3	2.5	2.9	3.3
13- 18	23	2.9	0.2	2.3	2.9	3.3	
19- 24	2	30	3.1	0.3	2.5	3.1	3.7
25- 30	31	3.2	0.3	2.7	3.1	3.7	
31- 36	3	53	3.3	0.3	2.6	3.2	3.7
37- 42	141	3.3	0.3	2.7	3.3	3.8	
43- 48	4	170	3.4	0.3	2.8	3.3	3.9
49- 54	186	3.5	0.3	2.9	3.4	4.1	
55- 60	5	175	3.6	0.3	2.9	3.5	4.2
61- 66	120	3.8	0.4	3.0	3.7	4.4	
67- 72	6	82	3.9	0.4	3.2	3.8	4.6
73- 78	99	4.0	0.4	3.2	3.9	4.6	
79- 84	7	95	4.1	0.4	3.2	4.0	4.6
85- 96	8	147	4.3	0.5	3.4	4.2	5.0
97-108	9	145	4.5	0.4	3.8	4.4	5.1
109-120	10	154	4.6	0.4	3.9	4.6	5.4
121-132	11	108	4.8	0.4	4.0	4.8	5.5
133-144	12	62	5.0	0.4	4.4	5.0	5.6
145-156	13	32	5.3	0.4	4.5	5.2	6.0

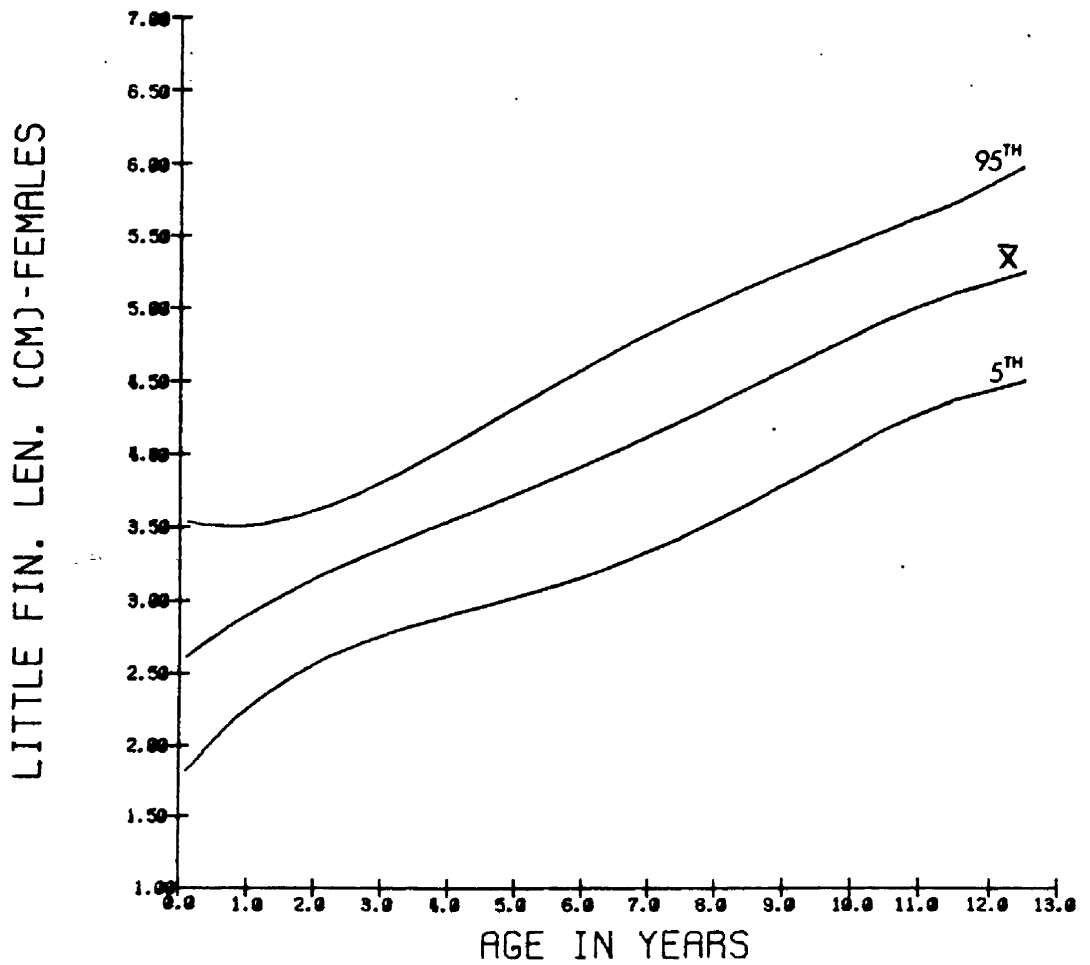

LITTLE FINGER LENGTH, IN CMS, - MALES

AGE(MO/YRS)	N	MEAN	S.D.	5%	50%	95%
0= 3	76	2.4	0.4	1.7	2.3	3.5
4= 6	43	2.8	0.4	2.3	2.6	3.7
7= 9	24	3.0	0.5	2.2	2.9	4.0
10= 12 1	18	2.9	0.4	2.2	2.8	3.9
13= 18	30	3.0	0.3	2.5	2.9	3.4
19= 24 2	40	3.1	0.2	2.5	3.1	3.4
25= 30	34	3.4	0.5	2.4	3.3	4.1
31= 36 3	49	3.4	0.3	2.7	3.3	3.9
37= 42	131	3.4	0.3	2.7	3.3	4.0
43= 48 4	123	3.5	0.4	2.8	3.4	4.2
49= 54	173	3.6	0.3	2.9	3.5	4.2
55= 60 5	155	3.6	0.3	2.9	3.5	4.1
61= 66	126	3.8	0.3	3.1	3.7	4.4
67= 72 6	94	3.9	0.4	3.1	3.9	4.4
73= 78	76	4.1	0.3	3.3	4.0	4.7
79= 84 7	77	4.1	0.4	3.3	4.1	4.8
85= 96 8	135	4.3	0.4	3.5	4.2	5.0
97=108 9	133	4.5	0.4	3.7	4.5	5.3
109=120 10	107	4.7	0.4	3.9	4.6	5.3
121=132 11	98	4.9	0.4	4.2	4.8	5.7
133=144 12	55	5.1	0.4	4.3	4.9	5.7
145=156 13	21	5.3	0.3	4.7	5.2	5.7

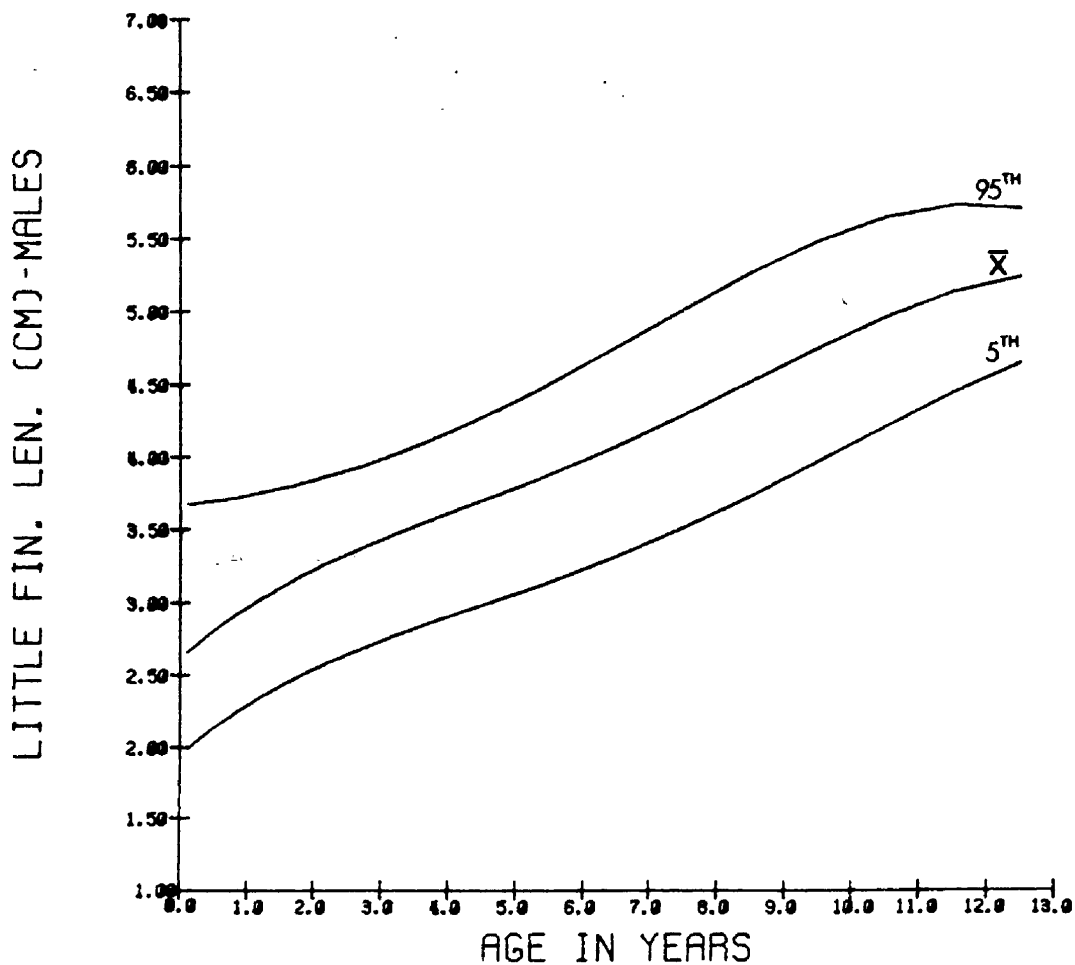

## LITTLE FINGER DIAMETER

Device: Plastic hole template. Measurements are coded and typed into computer via keyboard.

Description: INFANT: Fifth finger of right hand is extended. Measure the greatest diameter through which the first joint of the fifth finger cannot pass with a finger measurement board (see text for description of finger measurement board). An assistant is required to assure that the infant is in the correct position.

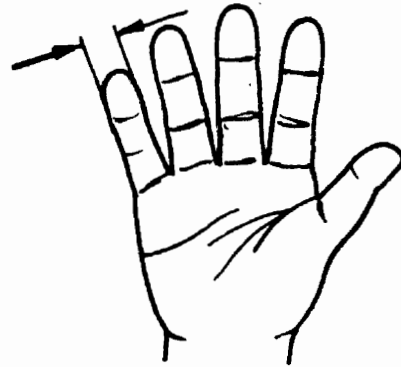

Description: CHILD: Fifth finger of right hand is extended. Measure the greatest diameter with a finger measurement board (see text for description of finger measurement board) through which the first joint of the fifth finger cannot pass.

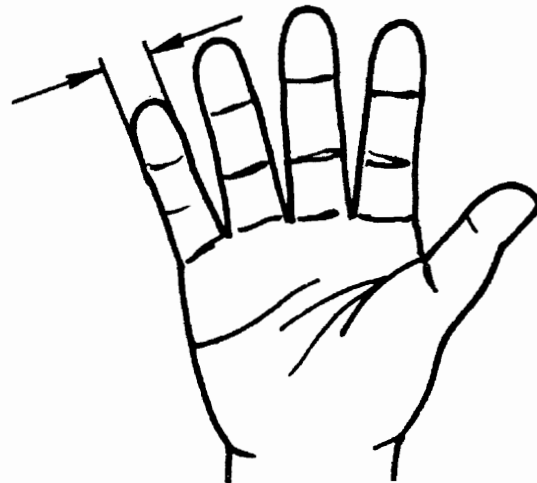

LITTLE FINGER DIAMETER, IN CMS. - COMBINED SEXES

AGE (MO/YRS)	N	MEAN	S.D.	SX	50%	95%
0-3	143	0.63	0.05	0.52	0.62	0.70
4-6	106	0.68	0.05	0.58	0.67	0.77
7-9	56	0.74	0.05	0.67	0.73	0.82
10-12	49	0.76	0.04	0.67	0.74	0.81
13-18	60	0.80	0.05	0.71	0.78	0.89
19-24	71	0.82	0.05	0.73	0.80	0.90
25-30	68	0.83	0.04	0.75	0.82	0.89
31-36	104	0.86	0.05	0.77	0.85	0.94
37-42	271	0.88	0.06	0.78	0.87	0.98
43-48	293	0.90	0.06	0.79	0.89	0.99
49-54	362	0.92	0.06	0.81	0.90	1.01
55-60	330	0.93	0.07	0.82	0.91	1.03
61-66	247	0.96	0.07	0.84	0.94	1.06
67-72	176	0.97	0.07	0.85	0.95	1.07
73-78	176	0.99	0.06	0.88	0.97	1.07
79-84	168	1.01	0.07	0.89	0.98	1.11
85-96	279	1.03	0.07	0.90	1.01	1.14
97-108	278	1.06	0.07	0.94	1.04	1.18
109-120	261	1.09	0.07	0.95	1.06	1.19
121-132	198	1.13	0.08	0.98	1.11	1.24
133-144	114	1.16	0.07	1.03	1.14	1.25
145-156	53	1.20	0.07	1.06	1.19	1.30

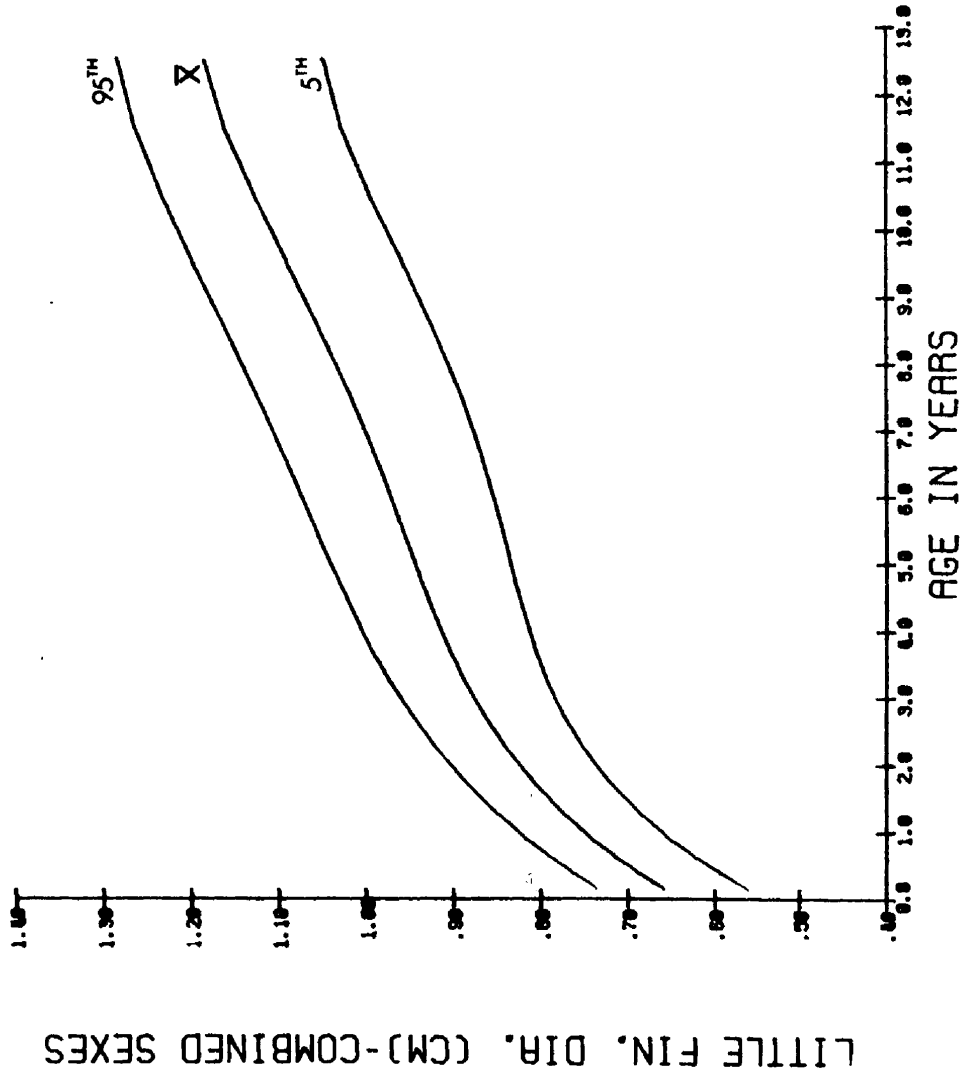

LITTLE FINGER DIAMETER, IN CMS. - FEMALES

AGE(MO/YRS)	N	MEAN	S.D.	5%	50%	95%	
0- 3	65	0.61	0.05	0.51	0.60	0.67	
4- 6	59	0.66	0.04	0.58	0.66	0.71	
7- 9	33	0.73	0.04	0.67	0.71	0.80	
10- 12	1	26	0.74	0.04	0.67	0.73	0.79
13- 18	25	0.77	0.05	0.68	0.75	0.85	
19- 24	2	31	0.79	0.05	0.72	0.77	0.88
25- 30	32	0.83	0.05	0.75	0.82	0.90	
31- 36	3	55	0.84	0.05	0.77	0.82	0.91
37- 42	141	0.86	0.05	0.78	0.85	0.93	
43- 48	4	171	0.88	0.06	0.78	0.86	0.95
49- 54	186	0.90	0.05	0.79	0.89	0.97	
55- 60	5	175	0.91	0.06	0.79	0.89	1.00
61- 66	121	0.94	0.06	0.81	0.93	1.02	
67- 72	6	82	0.94	0.06	0.84	0.93	1.02
73- 78	99	0.96	0.06	0.86	0.94	1.05	
79- 84	7	93	0.98	0.06	0.87	0.96	1.06
85- 96	8	145	1.00	0.06	0.89	0.99	1.07
97-108	9	145	1.03	0.06	0.91	1.01	1.13
109-120	10	153	1.06	0.06	0.93	1.04	1.15
121-132	11	104	1.10	0.07	0.95	1.08	1.19
133-144	12	63	1.13	0.06	1.01	1.11	1.20
145-156	13	32	1.19	0.05	1.11	1.17	1.26

LITTLE FIN. DIA. (CM)-FEMALES

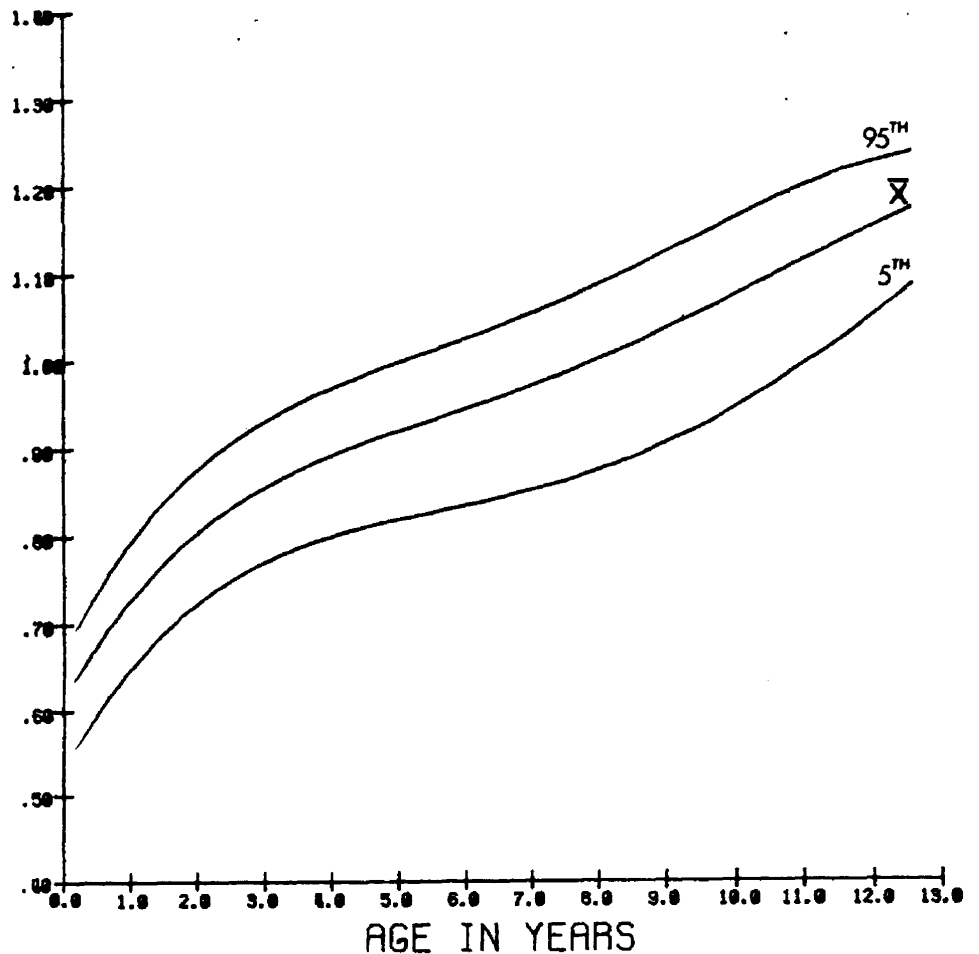

LITTLE FINGER DIAMETER, IN CMS. - MALES

AGE(MO/YRS)	N	MEAN	S.D.	5%	50%	95%
0- 3	78	0.64	0.05	0.55	0.63	0.71
4- 6	47	0.71	0.05	0.59	0.70	0.78
7- 9	23	0.76	0.05	0.67	0.73	0.82
10- 12	1	0.77	0.04	0.71	0.76	0.82
13- 18	35	0.81	0.05	0.72	0.80	0.89
19- 24	2	0.84	0.05	0.75	0.82	0.91
25- 30	36	0.84	0.04	0.75	0.82	0.88
31- 36	3	0.89	0.05	0.79	0.87	0.95
37- 42	130	0.91	0.05	0.82	0.90	1.00
43- 48	4	0.92	0.06	0.83	0.90	1.01
49- 54	176	0.94	0.06	0.84	0.93	1.02
55- 60	155	0.97	0.06	0.86	0.95	1.05
61- 66	126	0.99	0.07	0.89	0.97	1.09
67- 72	94	1.00	0.06	0.88	0.99	1.09
73- 78	77	1.02	0.05	0.90	1.00	1.09
79- 84	75	1.04	0.06	0.92	1.02	1.13
85- 96	134	1.07	0.07	0.93	1.05	1.15
97-108	133	1.09	0.07	0.96	1.07	1.20
109-120	108	1.12	0.06	0.99	1.10	1.21
121-132	94	1.16	0.07	1.01	1.14	1.26
133-144	51	1.19	0.06	1.06	1.17	1.27
145-156	21	1.22	0.09	1.03	1.21	1.35

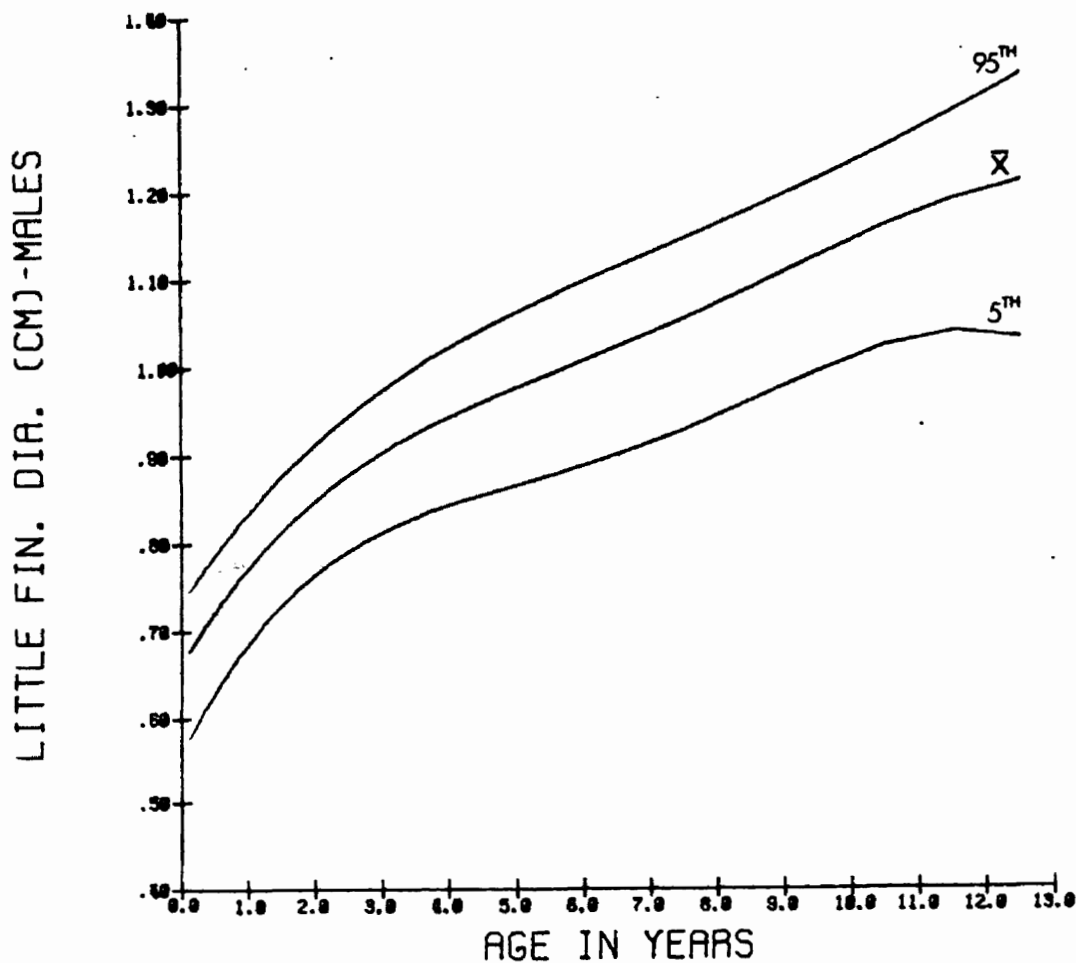

## MIDDLE FINGER LENGTH

Device: Automated sliding caliper. Measurements are recorded automatically by computer.

Description: INFANT: Infant lies on back with right hand and fingers fully extended, palm up. Measure the parallel distance from the skin crease at the base of the third digit to the tip of the third digit with an automated sliding caliper. The paddle-blade firmly contacts the two body surfaces for measurement. An assistant is required to assure that the infant is in the correct position.

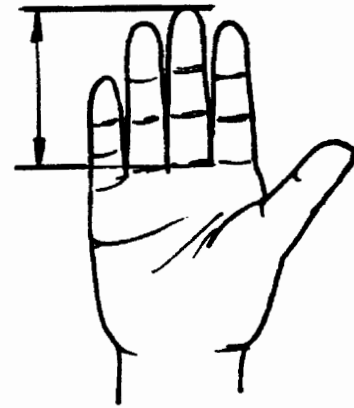
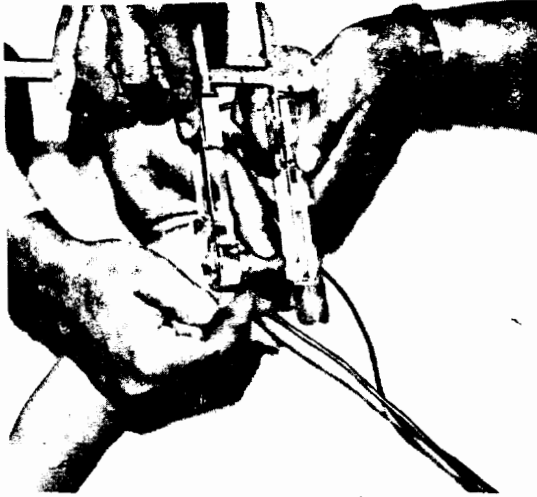

Description: CHILD: Hand and fingers are extended, palm up. Measure the parallel distance from the skin crease at the base of the third digit to the tip of the third digit with an automated sliding caliper. The paddle-blades firmly contact the two body surfaces for measurement.

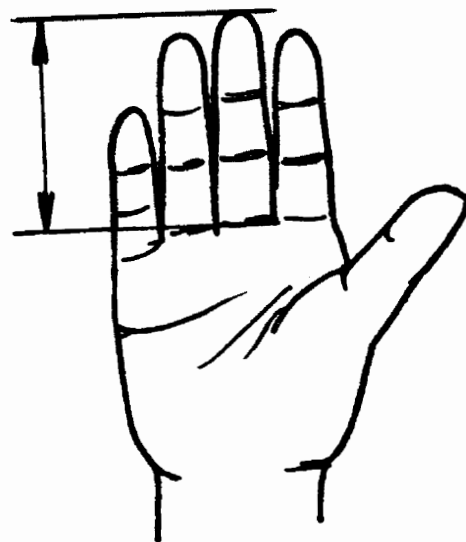
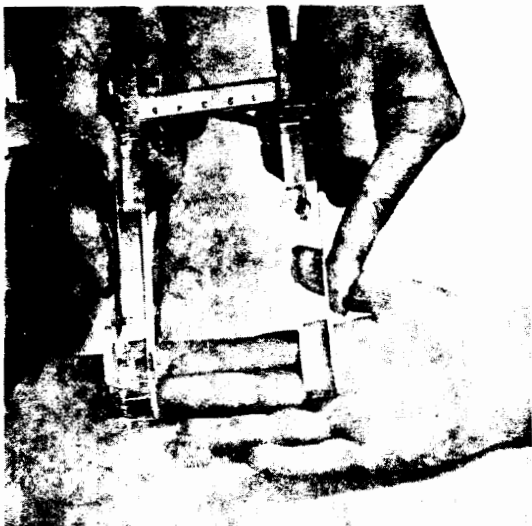

MIDDLE FINGER LENGTH, IN CMS. - COMBINED SEXES

AGE(MO/YRS)	N	MEAN	S.D.	5%	50%	95%
0= 3	138	3.0	0.4	2.3	2.9	3.9
4= 6	98	3.3	0.4	2.6	3.2	4.2
7= 9	49	3.6	0.4	2.9	3.5	4.2
10= 12 1	40	3.6	0.4	3.0	3.5	4.3
13= 18	53	3.9	0.3	3.3	3.8	4.5
19= 24 2	71	4.2	0.4	3.6	4.0	5.0
25= 30	64	4.3	0.4	3.6	4.2	4.9
31= 36 3	103	4.5	0.4	3.9	4.4	5.0
37= 42	272	4.6	0.3	4.0	4.5	5.1
43= 48 4	293	4.7	0.3	4.1	4.6	5.3
49= 54	359	4.9	0.3	4.2	4.8	5.5
55= 60 5	330	5.0	0.3	4.3	4.9	5.6
61= 66	245	5.1	0.4	4.4	5.1	5.8
67= 72 6	176	5.3	0.4	4.6	5.2	6.0
73= 78	175	5.4	0.4	4.7	5.3	6.1
79= 84 7	172	5.6	0.4	4.8	5.5	6.2
85= 96 8	281	5.8	0.4	5.1	5.7	6.5
97=108 9	278	6.1	0.4	5.3	6.0	6.8
109=120 10	263	6.2	0.4	5.4	6.1	7.0
121=132 11	293	6.5	0.4	5.8	6.5	7.2
133=144 12	118	6.7	0.4	5.8	6.6	7.5
145=156 13	53	7.1	0.5	6.1	7.0	7.8

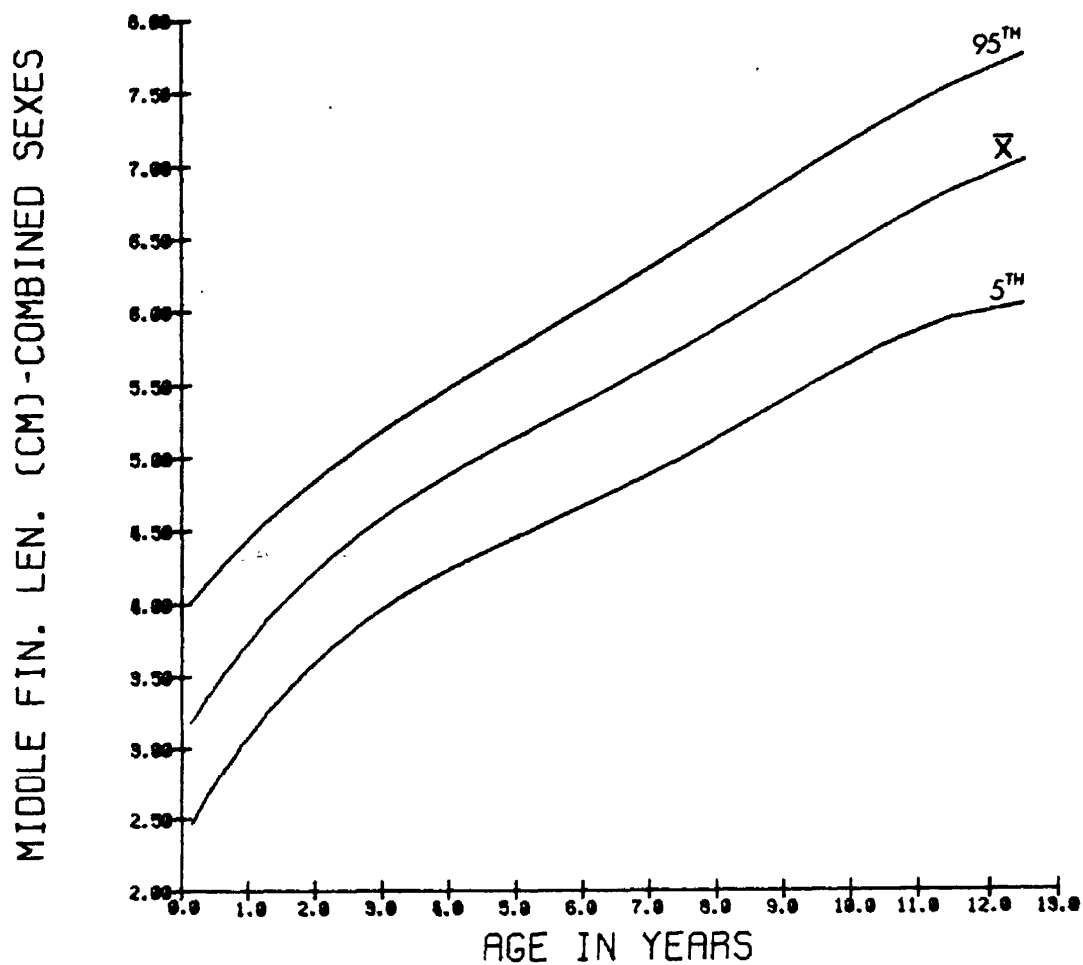



MIDDLE FINGER LENGTH, IN CMS. - FEMALES

AGE (MO/YRS)	N	MEAN	S.D.	5%	50%	95%	
0- 3	62	2.9	0.4	2.3	2.8	3.8	
4- 6	56	3.2	0.4	2.3	3.2	4.1	
7- 9	24	3.5	0.3	2.9	3.4	4.0	
10- 12	1	22	3.6	0.3	3.1	3.5	4.2
13- 18	23	3.8	0.3	2.9	3.8	4.1	
19- 24	2	29	4.2	0.4	3.6	4.8	4.9
25- 30	30	4.3	0.3	3.7	4.2	4.8	
31- 36	3	54	4.5	0.4	3.8	4.4	5.1
37- 42	141	4.6	0.3	4.0	4.5	5.1	
43- 48	170	4.7	0.3	4.1	4.6	5.3	
49- 54	186	4.8	0.3	4.1	4.8	5.4	
55- 60	175	5.0	0.3	4.3	4.9	5.5	
61- 66	119	5.2	0.4	4.4	5.1	5.9	
67- 72	82	5.3	0.4	4.7	5.2	6.0	
73- 78	99	5.4	0.4	4.8	5.3	6.1	
79- 84	7	95	5.6	0.3	4.8	5.5	6.1
85- 96	8	146	5.8	0.4	5.1	5.8	6.6
97-108	9	145	6.1	0.4	5.4	6.0	6.8
109-120	10	155	6.2	0.4	5.4	6.2	7.0
121-132	11	108	6.5	0.4	5.7	6.5	7.2
133-144	12	63	6.8	0.4	6.0	6.7	7.5
145-156	13	32	7.2	0.5	6.2	7.2	8.0

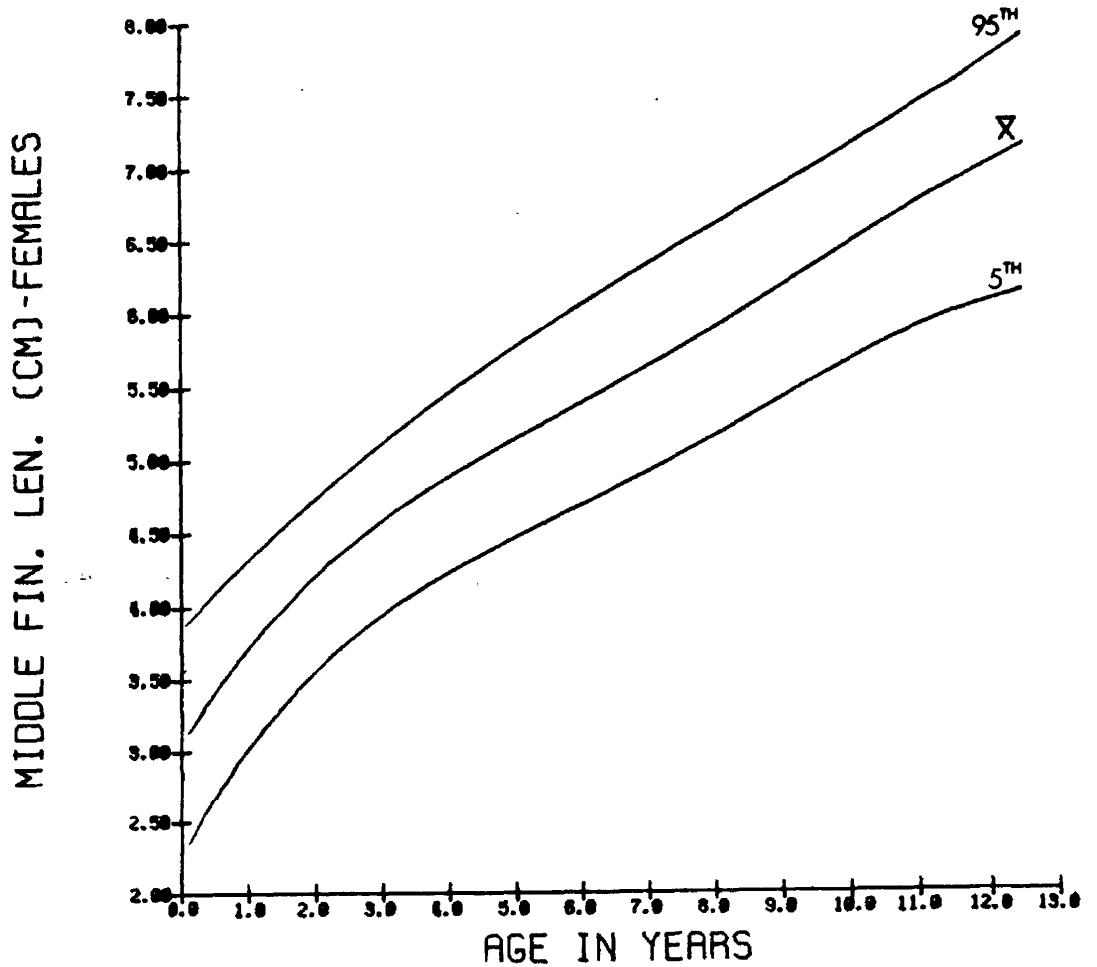

MIDDLE FINGER LENGTH, IN CMS. - MALES

AGE(MO/YRS)	N	MEAN	S.D.	5%	50%	95%	
0= 3	76	3.0	0.4	2.3	2.9	3.9	
4= 6	42	3.4	0.4	2.8	3.3	4.3	
7= 9	25	3.7	0.5	2.7	3.6	4.6	
10= 12	1	18	3.6	0.4	2.9	3.6	4.6
13= 18	30	3.9	0.3	3.3	3.9	4.5	
19= 24	2	42	4.2	0.4	3.6	4.0	5.0
25= 30	34	4.3	0.4	3.4	4.3	5.0	
31= 36	3	49	4.5	0.3	3.9	4.5	5.0
37= 42	131	4.6	0.3	4.0	4.5	5.1	
43= 48	4	123	4.7	0.4	4.1	4.6	5.4
49= 54	173	4.9	0.3	4.3	4.8	5.6	
55= 60	5	155	5.0	0.4	4.3	5.0	5.7
61= 66	126	5.1	0.4	4.3	5.0	5.7	
67= 72	6	94	5.2	0.4	4.5	5.2	5.9
73= 78	76	5.4	0.4	4.7	5.4	6.0	
79= 84	7	77	5.6	0.4	4.9	5.4	6.4
85= 96	8	135	5.8	0.4	5.0	5.7	6.5
97=108	9	133	6.0	0.4	5.2	5.9	6.8
109=120	10	108	6.1	0.4	5.3	6.0	6.9
121=132	11	95	6.5	0.3	5.8	6.5	7.1
133=144	12	55	6.6	0.5	5.6	6.5	7.4
145=156	13	21	6.9	0.4	6.1	6.8	7.5

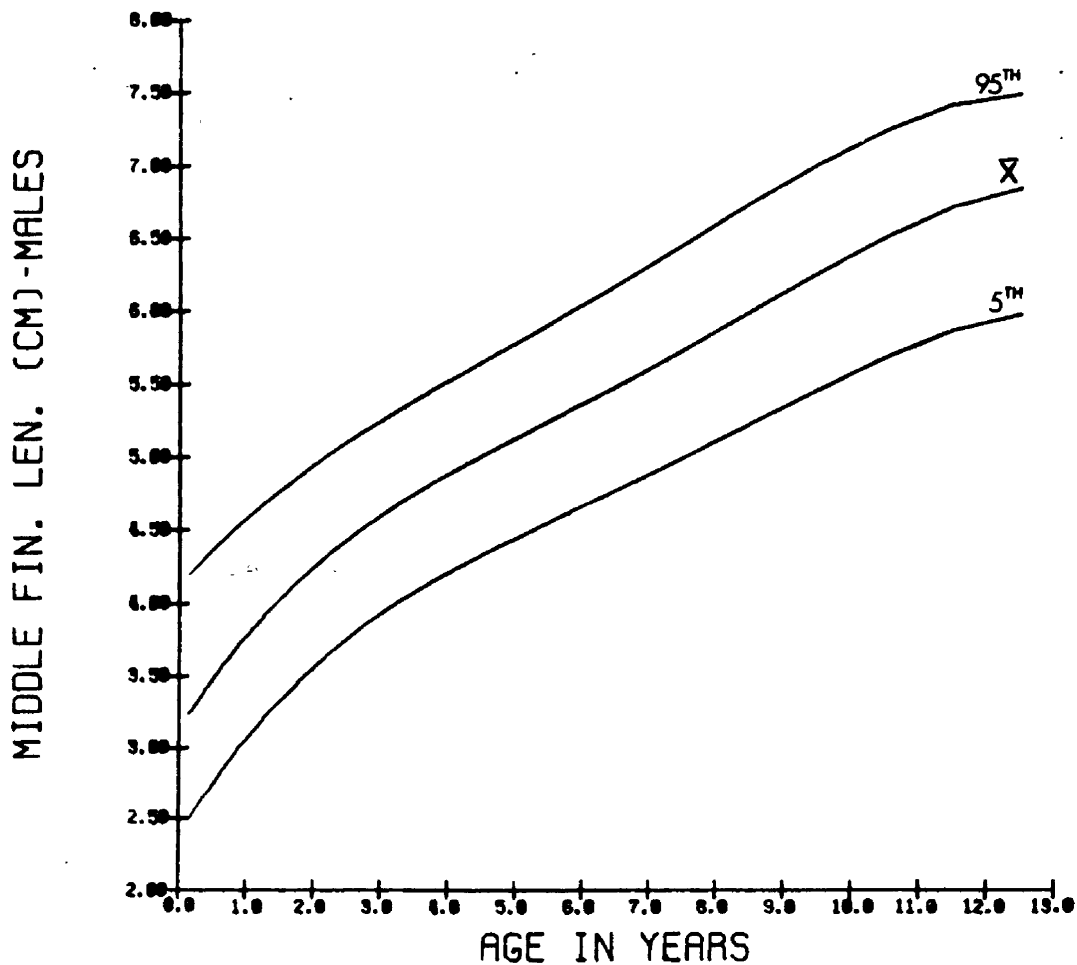

## MIDDLE FINGER DIAMETER

Device: Plastic hole template. Measurements are coded and typed into the computer via keyboard.

Description: INFANT: Third finger of right hand is extended. Measure the greatest diameter with a finger measurement board (see text for description of finger measurement board) through which the first joint of the third finger cannot pass.

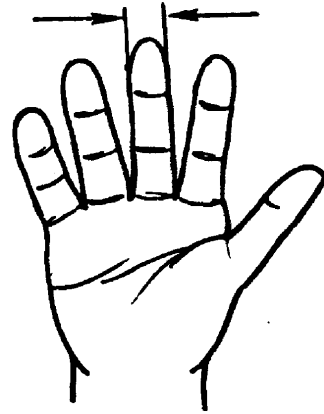

Description: CHILD: Third finger of right hand is extended. Measure the greatest diameter with a finger measurement board (see text for description of finger measurement board) through which the first joint of the third finger cannot pass.

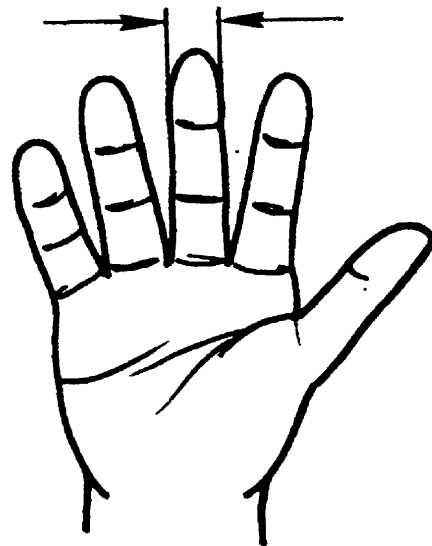

MIDDLE FINGER DIAMETER, IN CMS. - COMBINED SEXES

AGE(MO/YRS)	N	MEAN	S.D.	5%	50%	95%
0- 3	144	0.71	0.05		0.69	0.78
4- 6	105	0.78	0.06	0.60	0.77	0.85
7- 9	57	0.84	0.05	0.66	0.82	0.93
10- 12	49	0.86	0.06	0.75	0.83	0.93
13- 18	60	0.91	0.07	0.80	0.89	1.01
19- 24	71	0.94	0.06	0.84	0.93	1.03
25- 30	67	0.97	0.06	0.85	0.95	1.03
31- 36	104	1.00	0.07	0.86	0.99	1.10
37- 42	272	1.04	0.06	0.93	1.02	1.11
43- 48	294	1.06	0.07	0.92	1.03	1.15
49- 54	363	1.08	0.07	0.94	1.07	1.17
55- 60	331	1.10	0.07	0.96	1.09	1.20
61- 66	247	1.13	0.07	1.00	1.11	1.23
67- 72	175	1.15	0.08	1.00	1.13	1.26
73- 78	174	1.16	0.07	1.03	1.15	1.25
79- 84	171	1.19	0.08	1.05	1.17	1.31
85- 96	278	1.22	0.08	1.08	1.20	1.34
97-108	278	1.25	0.08	1.10	1.23	1.37
109-120	262	1.28	0.08	1.15	1.26	1.39
121-132	197	1.34	0.09	1.17	1.32	1.47
133-144	114	1.38	0.07	1.22	1.36	1.47
145-156	53	1.43	0.08	1.23	1.42	1.51

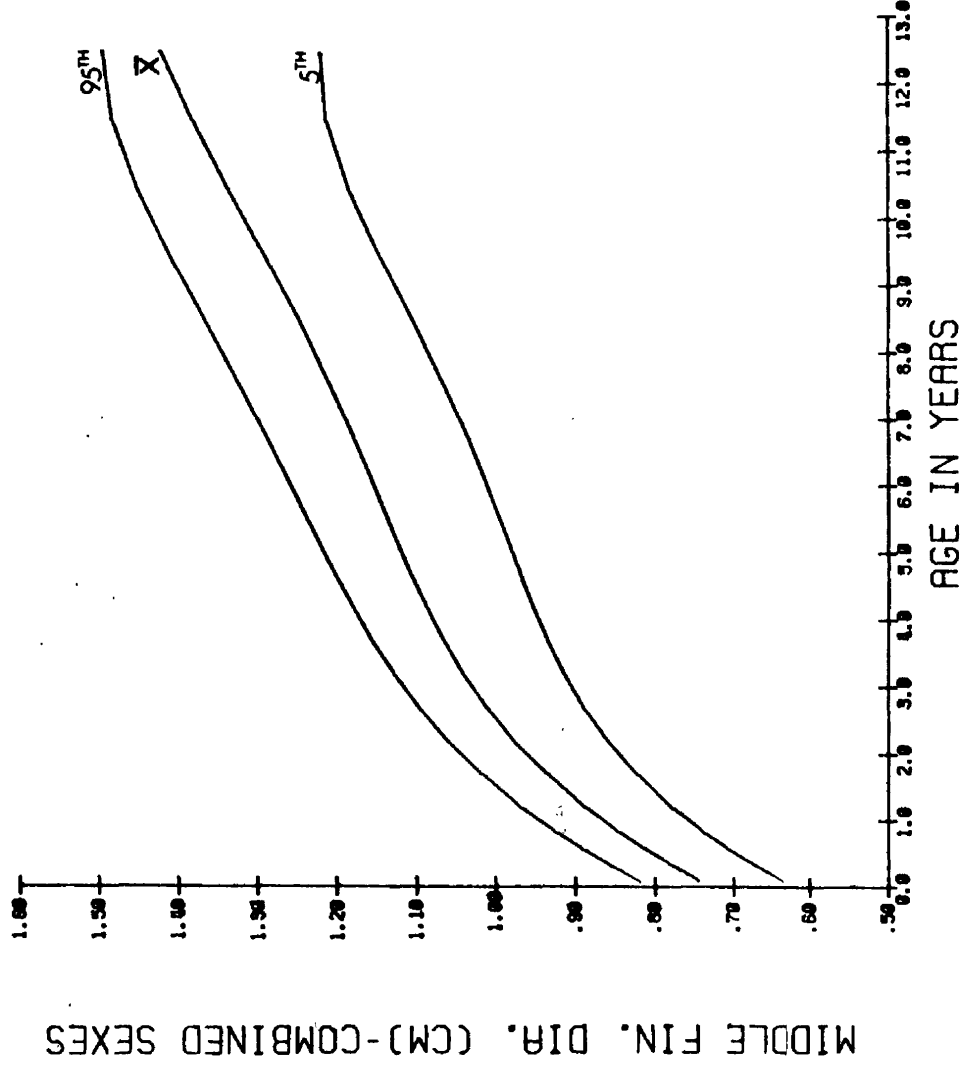

MIDDLE FINGER DIAMETER, IN CMS. - FEMALES

AGE(MO/YRS)	N	MEAN	S.D.	5%	50%	95%
0= 3	66	0.69	0.05	0.59	0.67	0.77
4= 6	58	0.75	0.05	0.66	0.74	0.82
7= 9	33	0.83	0.05	0.75	0.81	0.92
10= 12	1	26	0.83	0.04	0.75	0.88
13= 18	25	0.88	0.07	0.79	0.86	0.98
19= 24	2	31	0.91	0.05	0.83	0.90
25= 30	31	0.96	0.06	0.87	0.94	1.04
31= 36	3	55	0.98	0.07	0.83	0.97
37= 42	141	1.01	0.06	0.91	1.00	1.10
43= 48	171	1.04	0.07	0.91	1.01	1.13
49= 54	187	1.06	0.06	0.92	1.03	1.14
55= 60	176	1.08	0.07	0.92	1.06	1.18
61= 66	121	1.10	0.07	0.96	1.09	1.19
67= 72	81	1.11	0.07	0.99	1.09	1.21
73= 78	99	1.14	0.07	1.01	1.11	1.23
79= 84	93	1.16	0.07	1.01	1.15	1.25
85= 96	144	1.19	0.06	1.07	1.17	1.26
97=108	145	1.23	0.07	1.09	1.21	1.33
109=120	10	154	1.26	0.07	1.12	1.37
121=132	11	104	1.31	0.09	1.16	1.44
133=144	12	63	1.35	0.07	1.23	1.45
145=156	13	32	1.43	0.07	1.28	1.51

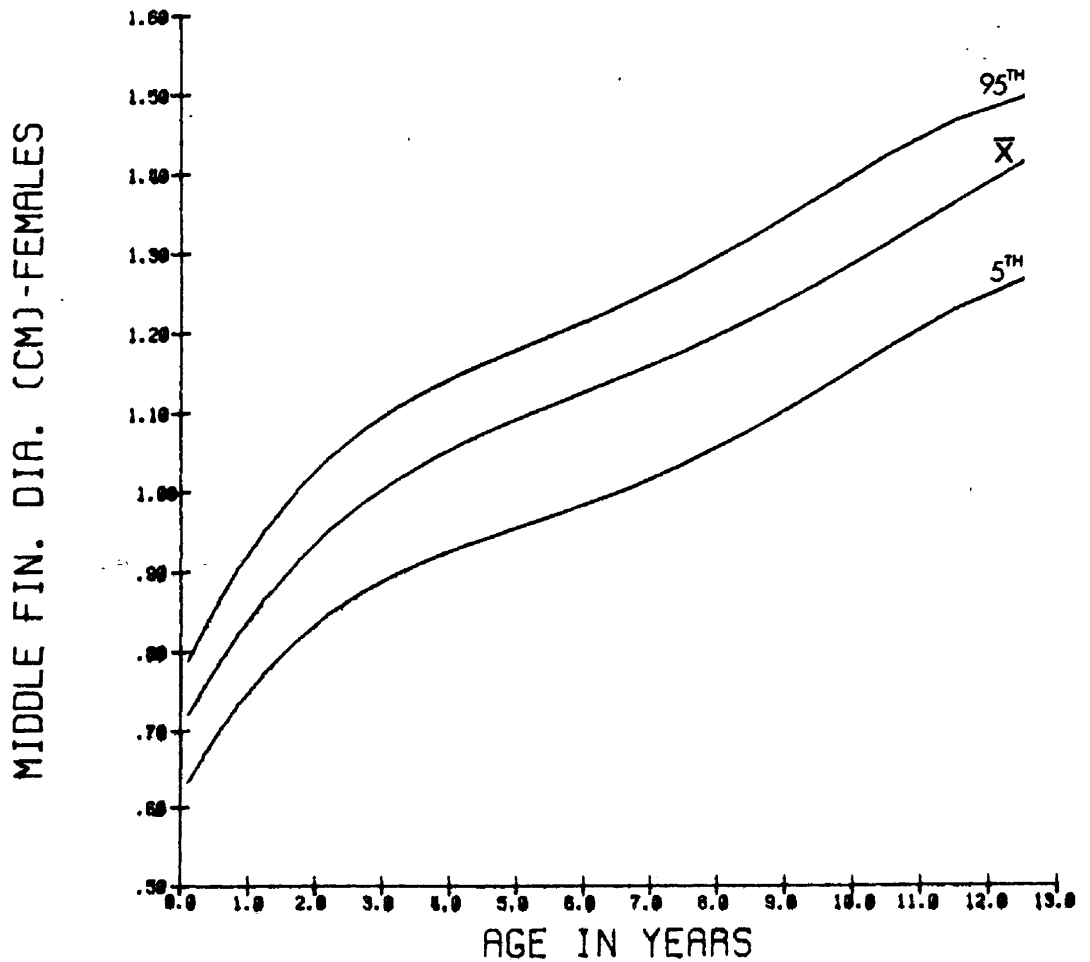

MIDDLE FINGER DIAMETER, IN CMS, - MALES

AGE (MO/YRS)	N	MFAN	S.D.	5%	50%	95%	
0- 3	78	0.73	0.05	0.63	0.73	0.79	
4- 6	47	0.80	0.05	0.69	0.79	0.87	
7- 9	24	0.86	0.05	0.79	0.83	0.94	
10- 12	1	23	0.89	0.05	0.79	0.89	0.94
13- 18	35	0.93	0.06	0.82	0.92	1.02	
19- 24	2	40	0.97	0.06	0.87	0.94	1.07
25- 30	36	0.98	0.06	0.86	0.97	1.03	
31- 36	3	49	1.02	0.06	0.90	1.01	1.10
37- 42	131	1.06	0.06	0.95	1.04	1.12	
43- 48	4	123	1.09	0.06	0.96	1.07	1.17
49- 54	176	1.11	0.07	0.99	1.09	1.19	
55- 60	5	155	1.13	0.07	1.00	1.11	1.22
61- 66	126	1.16	0.07	1.03	1.14	1.26	
67- 72	6	94	1.18	0.07	0.99	1.16	1.29
73- 78	75	1.19	0.06	1.07	1.17	1.26	
79- 84	7	78	1.22	0.07	1.11	1.19	1.33
85- 96	8	134	1.25	0.08	1.11	1.23	1.36
97-108	9	133	1.28	0.08	1.15	1.25	1.40
109-120	10	108	1.31	0.07	1.18	1.28	1.43
121-132	11	93	1.37	0.09	1.23	1.34	1.49
133-144	12	51	1.40	0.07	1.23	1.39	1.49
145-156	13	21	1.42	0.10	1.19	1.42	1.52

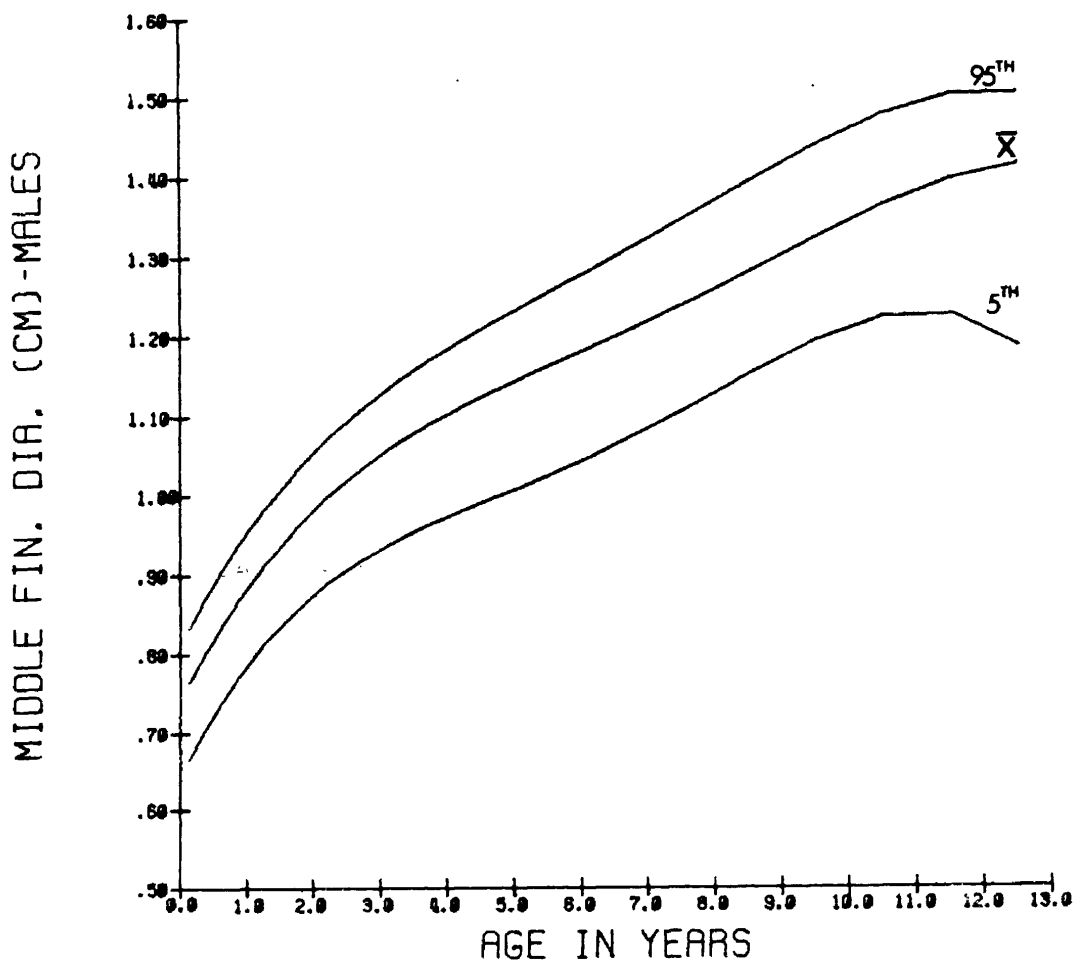

## MINIMUM HAND CLEARANCE

Device: Hinged plastic hole board. Measurements are coded and typed into the computer via keyboard.

Description: INFANT: Infant's right hand is extended. Measure the smallest diameter with the hand measurement board (see text for description of device) through which the measurer can pull the infant's hand. An assistant is required to assure that the infant is in the correct position.

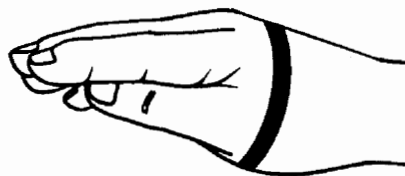

Description: CHILD: Subject extends right hand reduced to its narrowest configuration. Measure the smallest diameter with a hand measurement board (see text for description of device) through which the subject's hand can pass without forcing it.

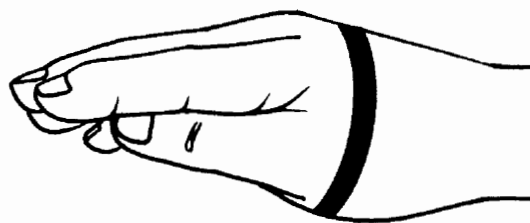

MINIMUM HAND CLEARANCE DIAMETER, IN CMS. - COMBINED SEXES

AGE(MO/YRS)	N	MEAN	S.D.	5%	50%	95%	
0= 3	142	3.28	0.30	2.60	3.11	3.67	
4= 6	101	3.63	0.29	3.18	3.47	4.00	
7= 9	56	3.93	0.26	3.49	3.77	4.23	
10= 12	1	48	3.99	0.30	3.32	3.81	4.38
13= 18	62	4.06	0.30	3.49	3.92	4.39	
19= 24	2	71	4.18	0.31	3.54	4.00	4.60
25= 30	66	4.27	0.24	3.81	4.11	4.56	
31= 36	3	103	4.40	0.31	3.81	4.24	4.76
37= 42	273	4.40	0.29	3.83	4.31	4.77	
43= 48	4	293	4.54	0.28	3.88	4.37	4.88
49= 54	363	4.65	0.28	4.03	4.48	5.00	
55= 60	5	327	4.73	0.32	4.02	4.57	5.13
61= 66	247	4.82	0.31	4.15	4.65	5.22	
67= 72	6	174	4.89	0.31	4.21	4.72	5.29
73= 78	174	4.94	0.31	4.23	4.77	5.33	
79= 84	7	170	5.00	0.31	4.45	4.92	5.43
85= 96	8	201	5.10	0.37	4.48	4.99	5.67
97=108	9	277	5.32	0.36	4.56	5.14	5.79
109=120	10	261	5.40	0.34	4.78	5.31	5.94
121=132	11	208	5.72	0.41	4.87	5.55	6.27
133=144	12	118	5.92	0.37	5.16	5.74	6.33
145=156	13	53	6.12	0.38	5.35	5.94	6.64

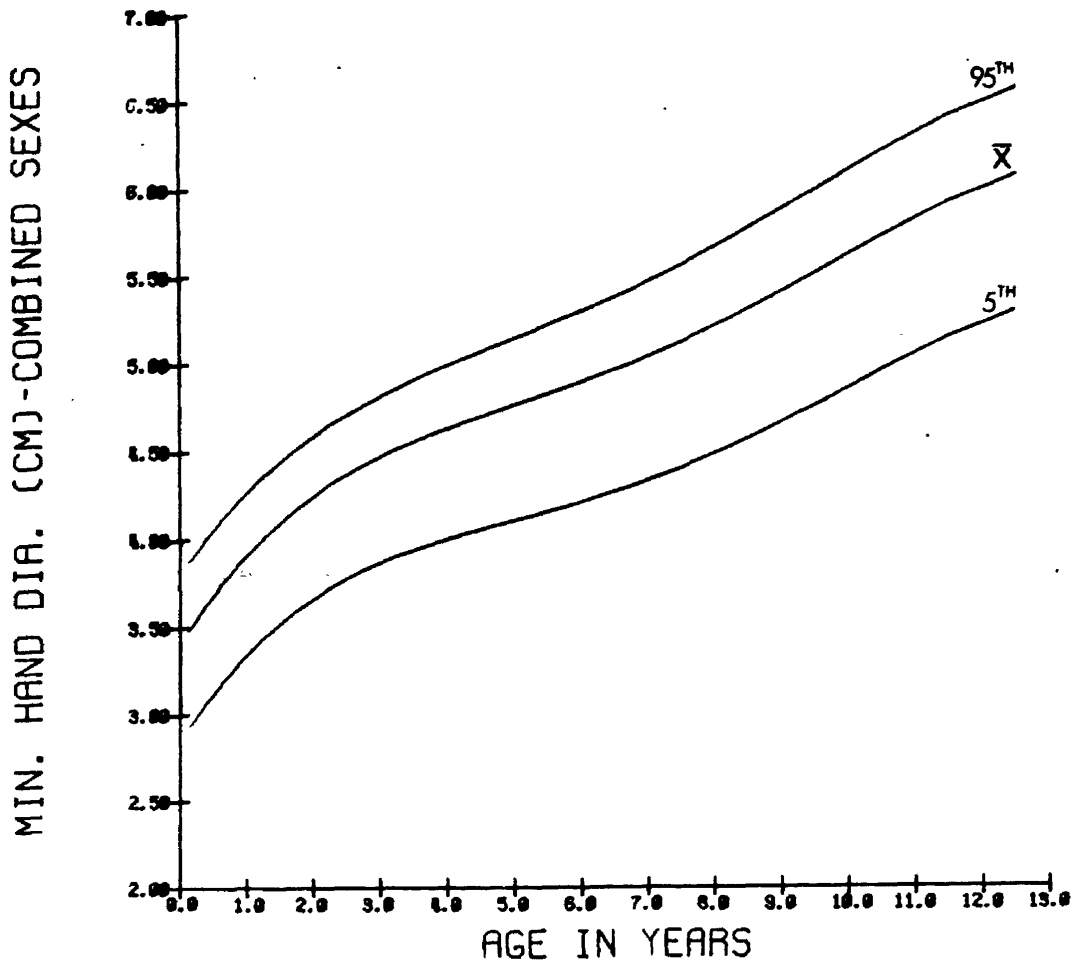



MINIMUM HAND CLEARANCE DIAMETER, IN CMS, - FEMALES

AGE(MO/YRS)	N	MEAN	S.D.	5%	50%	95%	
0- 3	64	3.21	0.29	2.57	3.05	3.49	
4- 6	57	3.55	0.28	3.10	3.37	3.95	
7- 9	30	3.84	0.24	3.49	3.67	4.11	
10- 12	1	26	3.86	0.25	3.21	3.71	4.08
13- 18	27	3.90	0.29	3.49	3.76	4.23	
19- 24	2	29	4.10	0.27	3.51	3.94	4.42
25- 30	31	4.26	0.27	3.81	4.06	4.64	
31- 36	3	55	4.30	0.32	3.81	4.11	4.73
37- 42	142	4.39	0.28	3.81	4.23	4.72	
43- 48	4	171	4.50	0.27	3.87	4.33	4.81
49- 54	187	4.58	0.26	3.94	4.41	4.89	
55- 60	5	174	4.66	0.30	3.96	4.51	5.03
61- 66	121	4.73	0.31	4.13	4.57	5.08	
67- 72	6	82	4.79	0.28	4.17	4.62	5.14
73- 78	98	4.88	0.33	4.19	4.68	5.32	
79- 84	7	94	5.01	0.31	4.45	5.38	
85- 96	8	147	5.08	0.34	4.47	5.57	
97-108	9	145	5.22	0.33	4.51	5.66	
109-120	14	153	5.42	0.33	4.77	5.89	
121-132	11	108	5.60	0.40	4.83	6.19	
133-144	12	63	5.82	0.34	5.13	6.27	
145-156	13	32	6.16	0.37	5.46	6.73	

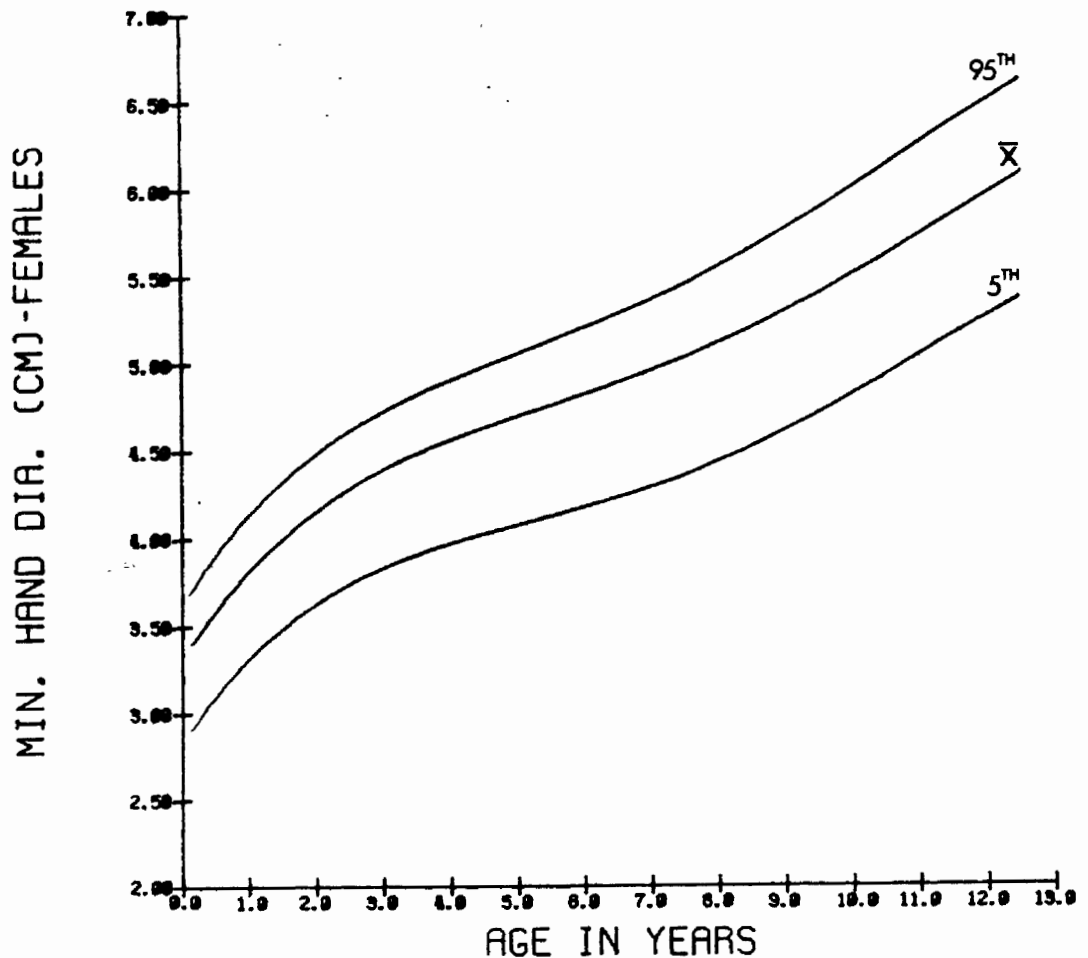

MINIMUM HAND CLEARANCE DIAMETER, IN CMS. - MALES

AGE (MO/YRS)	N	MEAN	S.D.	5%	50%	95%	
0- 3	78	3.33	0.30	2.63	3.18	3.71	
4- 6	44	3.73	0.26	3.18	3.59	4.03	
7- 9	26	4.03	0.25	3.49	3.90	4.31	
10- 12	1	22	4.14	0.29	3.81	3.97	4.44
13- 18	35	4.18	0.24	3.81	4.01	4.43	
19- 24	2	42	4.24	0.32	3.81	4.05	4.74
25- 30	35	4.29	0.22	3.81	4.16	4.44	
31- 36	3	48	4.51	0.24	4.13	4.33	4.82
37- 42	131	4.57	0.28	3.91	4.39	4.92	
43- 48	4	122	4.59	0.28	3.91	4.46	4.93
49- 54	176	4.73	0.29	4.15	4.56	5.05	
55- 60	5	153	4.82	0.32	4.14	4.65	5.23
61- 66	126	4.90	0.29	4.22	4.73	5.28	
67- 72	6	92	4.99	0.30	4.42	4.82	5.34
73- 78	76	5.01	0.27	4.46	4.86	5.33	
79- 84	7	76	5.16	0.30	4.49	5.00	5.52
85- 96	8	134	5.28	0.38	4.51	5.12	5.74
97-108	9	132	5.42	0.35	4.76	5.25	5.92
109-120	10	108	5.56	0.33	4.81	5.42	5.98
121-132	11	100	5.85	0.38	5.10	5.67	6.31
133-144	12	55	6.03	0.37	5.41	5.87	6.55
145-156	13	21	6.06	0.40	5.10	5.95	6.50

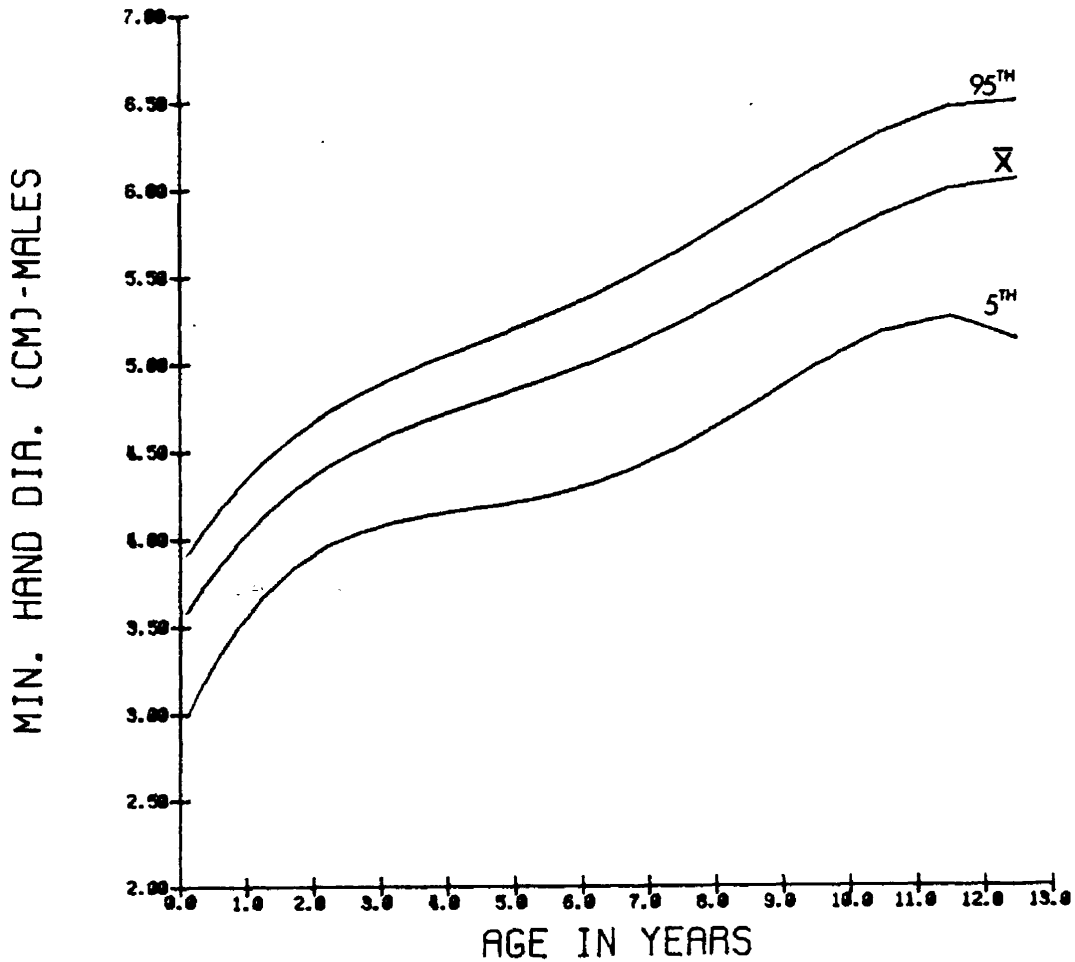

## INSIDE GRIP DIAMETER

Device: Grip measurement cone. Measurements are coded and typed into the computer via keyboard.

Description: INFANT: Infant's right hand is placed and held on measurement cone (see text for description of measurement cone) at the maximum diameter at which the tips of thumb and middle finger just touch. Record the maximum diameter indicated on the measurement cone. An assistant is required to assure that the infant is in the correct position.

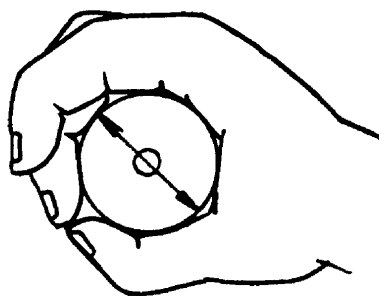

Description: CHILD: Child grasps the measurement cone with right hand at the maximum diameter at which the tips of the thumb and middle finger touch. Record the maximum diameter indicated on the measurement cone.

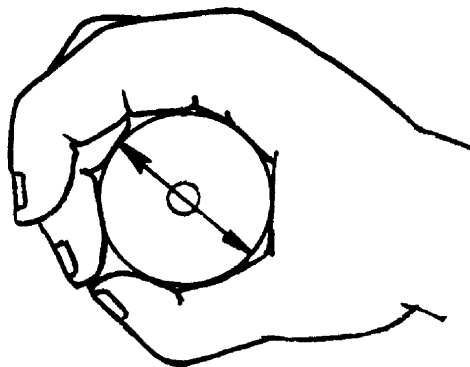

INSIDE GRIP DIAMETER, IN CMS. - COMBINED SEXES

AGE(MO/YRS)	N	MEAN	S.D.	5%	50%	95%	
0- 3	134	1.71	0.19	1.43	1.61	1.99	
4- 6	102	1.94	0.19	1.59	1.85	2.20	
7- 9	52	2.09	0.20	1.64	2.02	2.34	
10- 12	1	42	2.18	0.20	1.75	2.10	2.47
13- 18	57	2.38	0.23	1.93	2.31	2.68	
19- 24	2	68	2.58	0.18	2.23	2.51	2.81
25- 30	65	2.74	0.25	2.26	2.64	3.13	
31- 36	3	103	2.89	0.24	2.41	2.81	3.21
37- 42	272	2.98	0.21	2.57	2.89	3.25	
43- 48	4	293	3.03	0.23	2.60	2.93	3.33
49- 54	361	3.16	0.23	2.72	3.07	3.49	
55- 60	5	329	3.25	0.24	2.78	3.15	3.61
61- 66	245	3.32	0.26	2.81	3.24	3.68	
67- 72	6	175	3.43	0.26	2.85	3.33	3.80
73- 78	176	3.54	0.25	3.08	3.44	3.86	
79- 84	7	171	3.61	0.26	3.18	3.51	3.96
85- 96	8	279	3.79	0.28	3.27	3.67	4.23
97-108	9	271	3.96	0.30	3.44	3.83	4.45
109-120	10	258	4.09	0.35	3.54	3.99	4.64
121-132	11	203	4.33	0.35	3.70	4.24	4.87
133-144	12	117	4.47	0.37	3.78	4.38	5.00
145-156	13	53	4.74	0.39	3.95	4.61	5.30

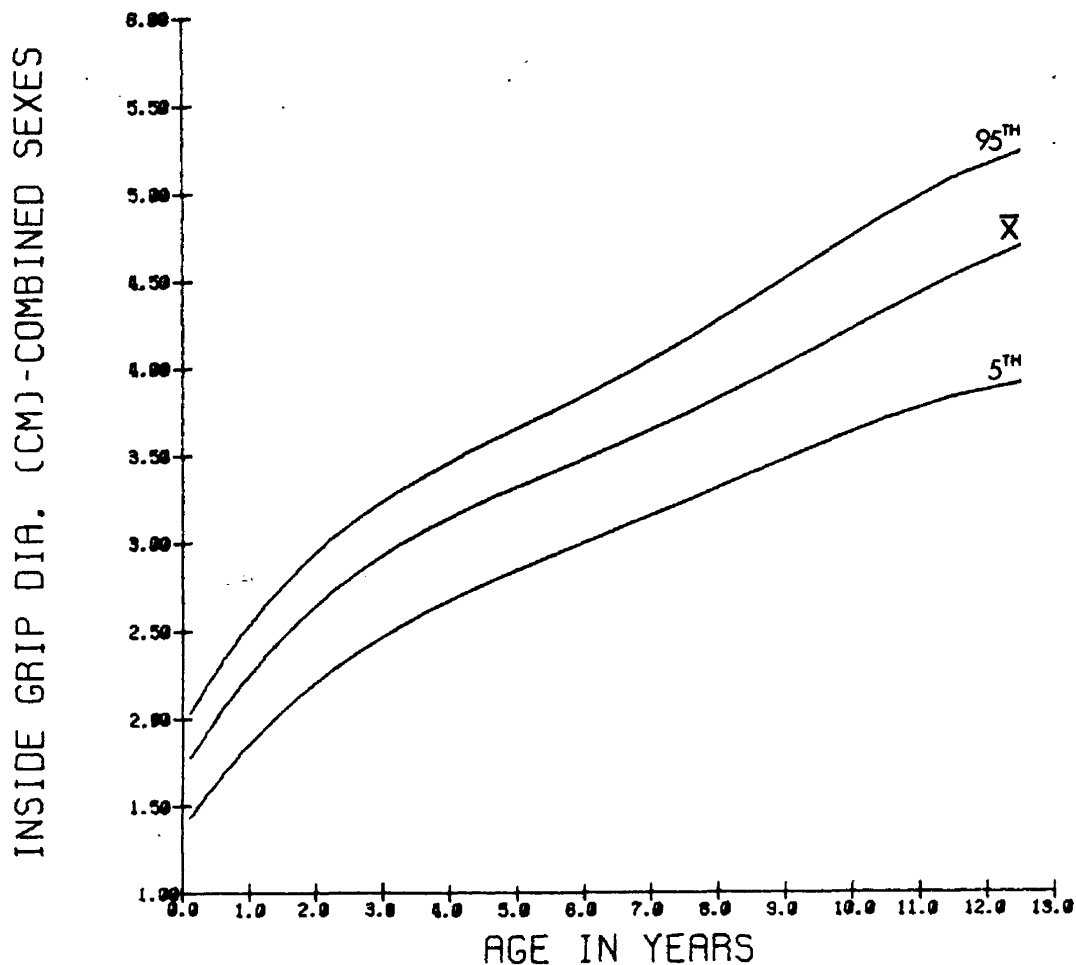

INSIDE GRIP DIAMETER, IN CMS. - FEMALES

AGE (MO/YRS)	N	MEAN	S.D.	5%	50%	95%
0- 3	60	1.68	0.18	1.43	1.58	1.91
4- 6	55	1.91	0.19	1.59	1.82	2.17
7- 9	29	2.12	0.21	1.66	2.06	2.35
10- 12	1	2.17	0.18	1.91	2.08	2.45
13- 18	26	2.35	0.24	1.77	2.29	2.69
19- 24	2	2.57	0.20	2.23	2.48	2.84
25- 30	30	2.72	0.24	2.26	2.62	3.10
31- 36	3	2.87	0.23	2.42	2.78	3.20
37- 42	141	2.96	0.19	2.57	2.89	3.17
43- 48	170	3.02	0.22	2.62	2.92	3.31
49- 54	186	3.13	0.23	2.71	3.05	3.45
55- 60	175	3.23	0.25	2.75	3.12	3.60
61- 66	120	3.29	0.26	2.78	3.21	3.65
67- 72	81	3.40	0.26	2.83	3.30	3.79
73- 78	99	3.52	0.25	3.07	3.41	3.82
79- 84	95	3.58	0.26	3.18	3.48	3.93
85- 96	146	3.77	0.27	3.32	3.66	4.14
97-100	9	4.00	0.30	3.50	3.87	4.49
109-120	10	4.06	0.37	3.54	3.95	4.65
121-132	11	4.34	0.38	3.68	4.25	4.91
133-144	12	4.51	0.38	3.75	4.48	4.97
145-156	13	4.87	0.36	4.24	4.82	5.35

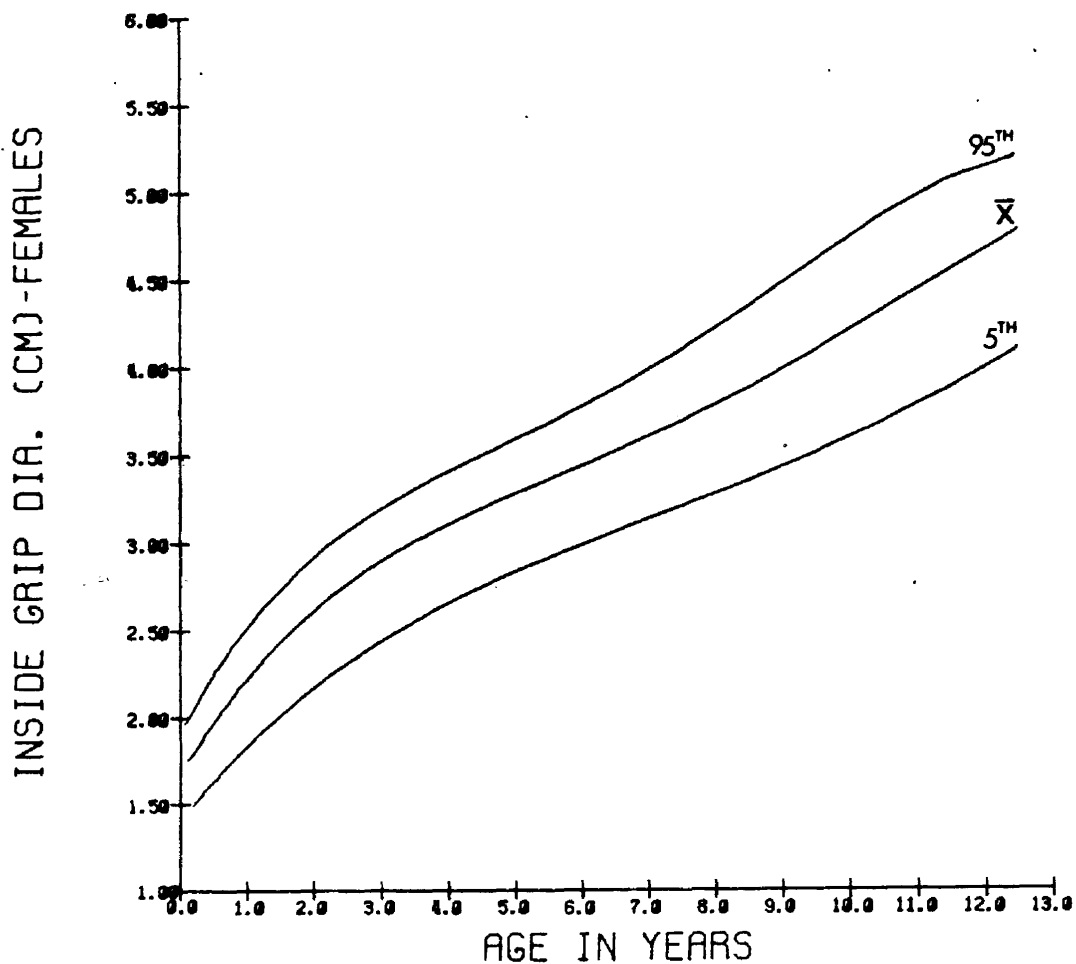

INSIDE GRIP DIAMETER, IN CMS. - MALES

AGE(MO/YRS)	N	MEAN	S.D.	5%	50%	95%
0- 3	74	1.73	0.19	1.43	1.64	2.02
4- 6	47	1.97	0.19	1.59	1.88	2.26
7- 9	23	2.06	0.20	1.61	1.99	2.30
10- 12	1	2.20	0.23	1.75	2.13	2.55
13- 18	31	2.41	0.22	1.95	2.33	2.67
19- 24	2	2.59	0.17	2.23	2.53	2.79
25- 30	35	2.76	0.25	2.27	2.65	3.14
31- 36	3	2.91	0.26	2.40	2.85	3.22
37- 42	131	3.00	0.23	2.58	2.90	3.29
43- 48	4	3.04	0.24	2.59	2.94	3.37
49- 54	175	3.19	0.23	2.75	3.10	3.53
55- 60	5	3.27	0.23	2.85	3.18	3.61
61- 66	125	3.35	0.27	2.86	3.26	3.71
67- 72	6	3.46	0.26	3.02	3.35	3.81
73- 78	77	3.57	0.25	3.09	3.48	3.88
79- 84	7	3.65	0.25	3.20	3.54	4.00
85- 96	8	3.81	0.30	3.24	3.69	4.27
97-100	9	3.93	0.30	3.40	3.79	4.42
109-120	10	4.12	0.32	3.54	4.04	4.61
121-132	11	4.32	0.33	3.75	4.22	4.82
133-144	12	4.42	0.36	3.82	4.29	5.05
145-156	13	4.54	0.36	3.83	4.42	5.17

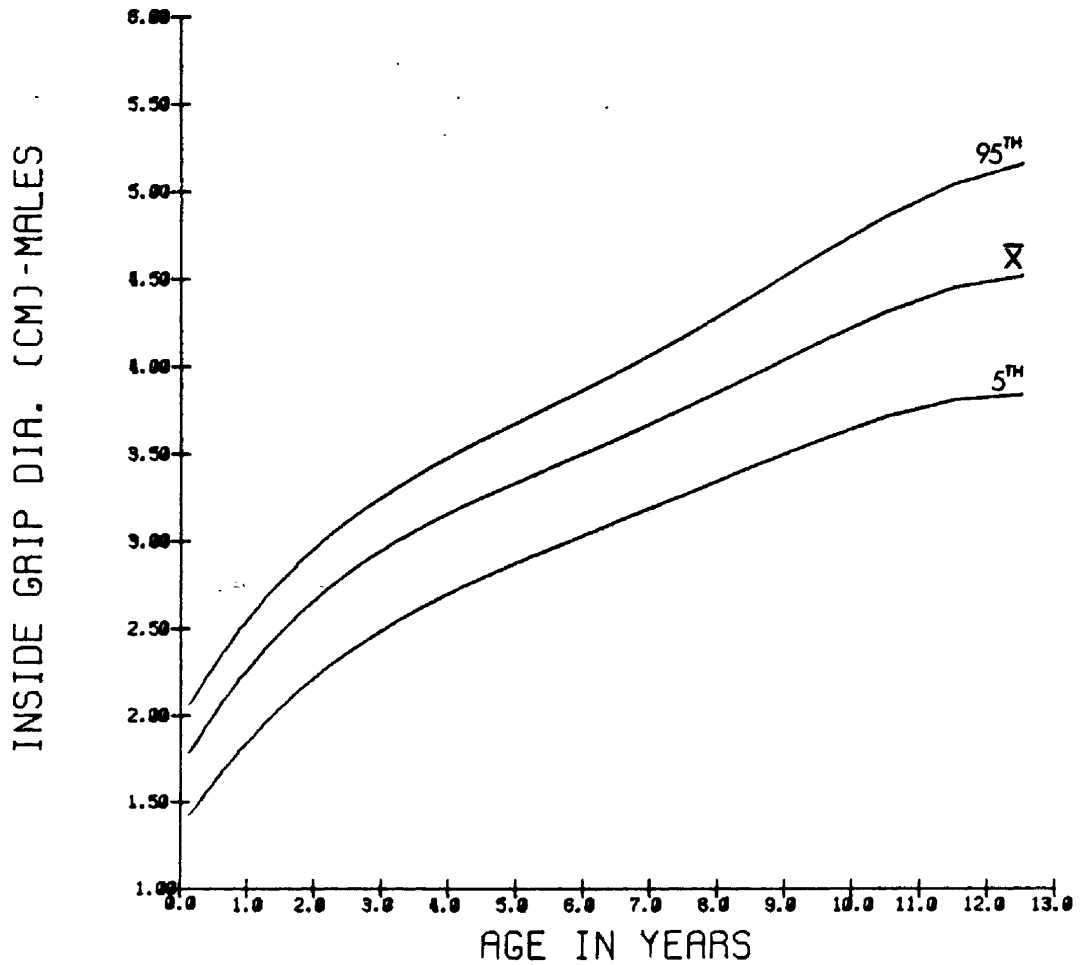

## OUTSIDE GRIP DIAMETER

Device: Automated sliding caliper and measurement cone. Measurement is made with sliding caliper and recorded automatically by computer.

Description: INFANT: Infant grips the measurement cone with the right hand at maximum diameter (see text for description of inside grip diameter). Measure the maximum outside grip diameter from the proximal phalanx-medial phalanx joint of the middle finger to the metacarpo-phalangeal joint of the thumb with the automated sliding caliper. An assistant is required to assure that hand maintains its correct position.

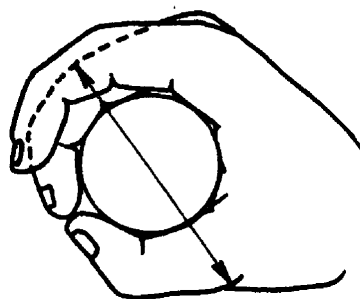
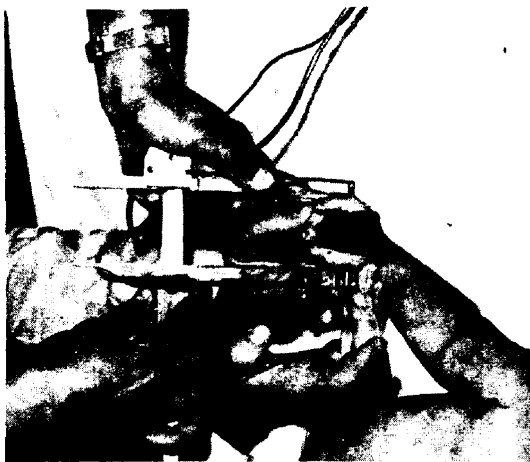

Description: CHILD: Child grips the measurement cone with the right hand at maximum diameter (see text for description of inside grip diameter). Measure the maximum outside grip diameter from the proximal phalanx-medial phalanx joint of the middle finger to the metacarpo-phalangeal joint of the thumb with the automated sliding caliper.

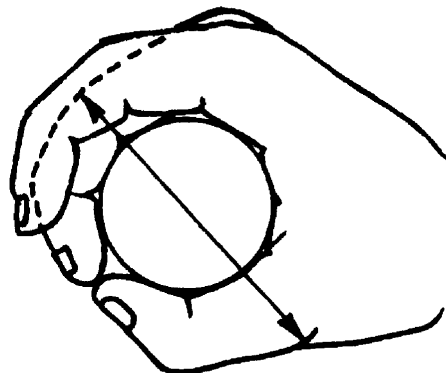
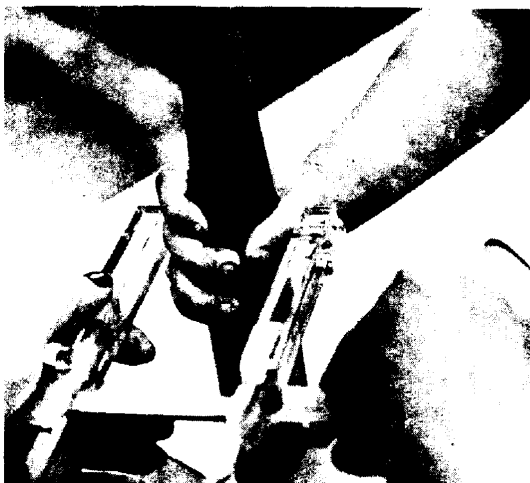

OUTSIDE GRIP DIAMETER, IN CMS. - COMBINED SEXES

AGE(MO/YRS)	N	MEAN	S.D.	5%	50%	95%	
0= 3	133	3.6	0.5	2.8	3.5	4.6	
4= 6	99	4.0	0.4	3.4	3.9	4.9	
7= 9	51	4.4	0.4	3.7	4.4	5.0	
10= 12	1	38	4.5	0.3	3.8	4.4	5.0
13= 18	57	4.6	0.3	4.0	4.5	5.1	
19= 24	2	67	5.0	0.3	4.3	4.9	5.5
25= 30	63	5.1	0.4	4.4	5.1	5.9	
31= 36	3	103	5.4	0.4	4.6	5.3	6.0
37= 42	272	5.4	0.4	4.8	5.3	6.1	
43= 48	4	291	5.5	0.4	4.9	5.4	6.2
49= 54	358	5.7	0.3	5.1	5.6	6.3	
55= 60	5	329	5.8	0.4	5.2	5.8	6.5
61= 66	245	6.1	0.4	5.3	6.0	6.8	
67= 72	6	175	6.2	0.4	5.5	6.1	6.9
73= 78	174	6.4	0.4	5.7	6.3	7.2	
79= 84	7	173	6.5	0.4	5.7	6.4	7.3
85= 96	8	280	6.8	0.5	5.9	6.7	7.5
97=108	9	274	7.0	0.5	6.2	7.0	7.8
109=120	10	260	7.2	0.5	6.4	7.2	8.0
121=132	11	205	7.6	0.6	6.5	7.5	8.6
133=144	12	116	7.8	0.5	6.8	7.8	8.7
145=156	13	53	8.1	0.6	7.2	7.9	9.2

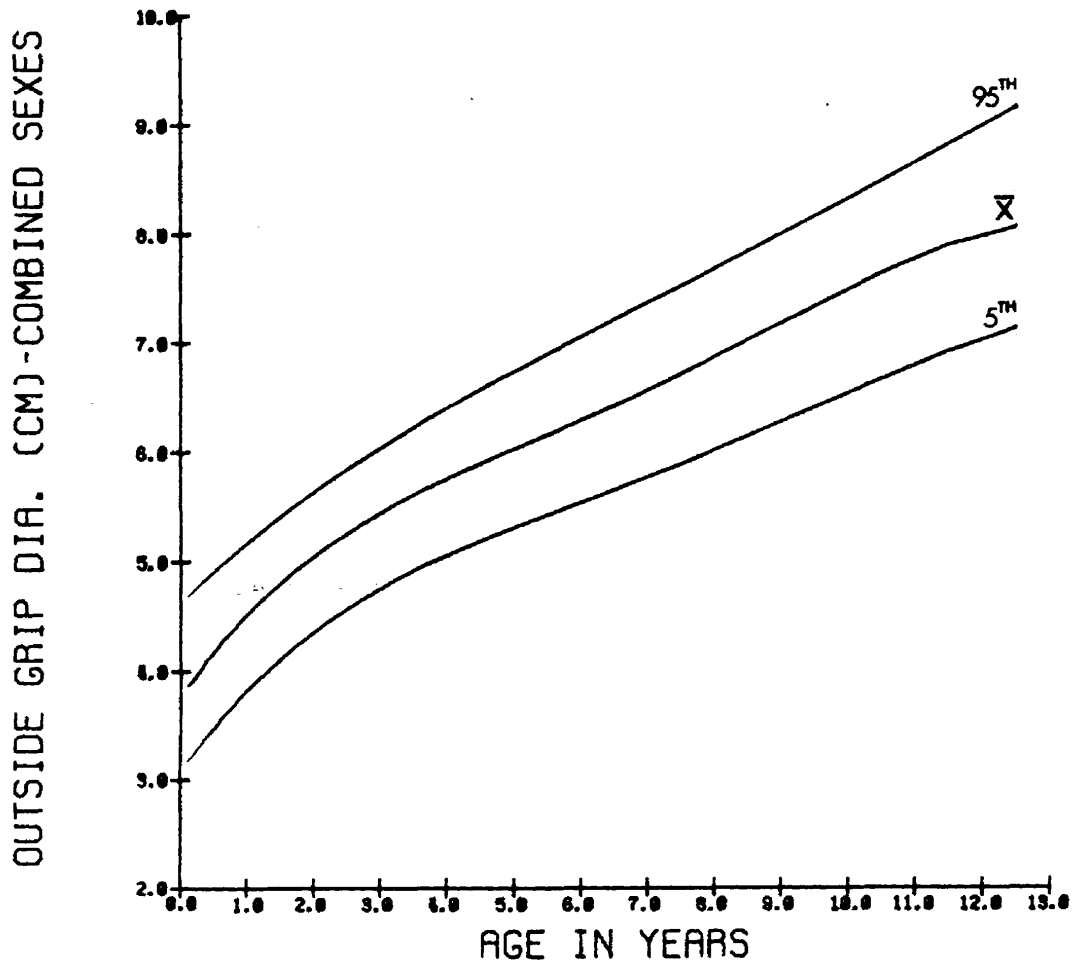



OUTSIDE GRIP DIAMETER, IN CMS. - FEMALES

AGE(MO/YRS)	N	MEAN	S.D.	5X	50X	95X
0= 3	60	3.6	0.4	2.9	3.4	4.3
4= 6	53	4.0	0.4	3.3	3.8	4.6
7= 9	28	4.4	0.4	3.3	4.4	5.0
10= 12 1	21	4.5	0.3	4.1	4.5	5.0
13= 18	26	4.5	0.3	4.0	4.5	5.1
19= 24 2	28	4.9	0.3	4.3	4.8	5.5
25= 30	29	5.0	0.3	4.3	4.8	5.7
31= 36 3	54	5.3	0.4	4.6	5.3	5.9
37= 42	141	5.4	0.3	4.7	5.3	5.9
43= 48 4	168	5.5	0.4	4.8	5.4	6.1
49= 54	186	5.6	0.3	5.0	5.6	6.2
55= 60 5	174	5.8	0.4	5.1	5.8	6.4
61= 66	120	6.0	0.4	5.2	6.0	6.7
67= 72 6	81	6.2	0.4	5.6	6.1	6.9
73= 78	99	6.3	0.4	5.7	6.2	7.1
79= 84 7	95	6.4	0.4	5.6	6.4	7.2
85= 96 8	146	6.7	0.4	5.9	6.6	7.3
97=108 9	144	7.0	0.5	6.2	6.9	7.8
109=120 10	153	7.2	0.5	6.3	7.1	8.0
121=132 11	107	7.6	0.6	6.5	7.5	8.6
133=144 12	61	7.7	0.5	6.5	7.8	8.5
145=156 13	32	8.2	0.5	7.4	8.1	9.2

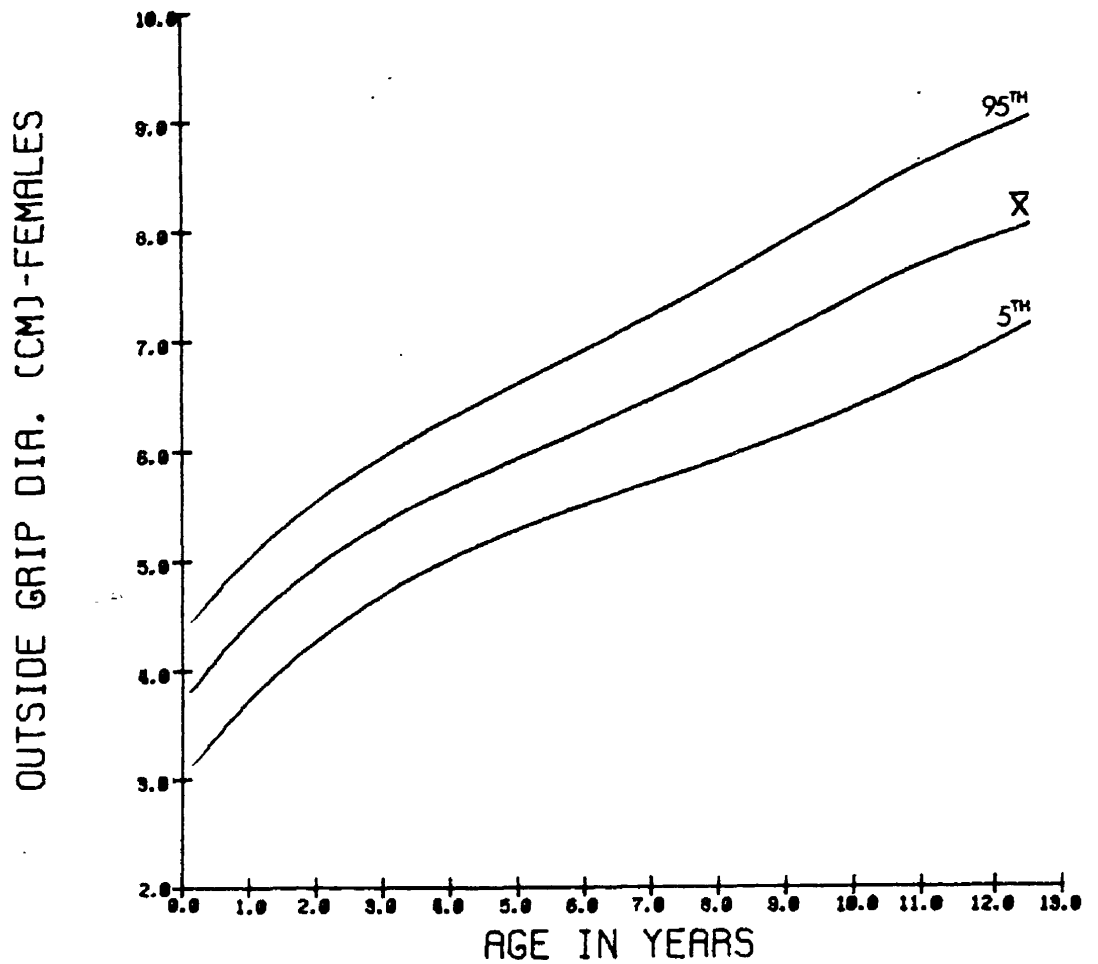

OUTSIDE GRIP DIAMETER, IN CMS. - MALES

AGE(MO/YRS)	N	MEAN	S.D.	5%	50%	95%	
0- 3	73	3.7	0.5	2.8	3.6	4.7	
4- 6	46	4.1	0.4	3.5	4.0	5.2	
7- 9	23	4.4	0.4	3.7	4.3	5.0	
10- 12	1	17	4.4	0.3	3.8	4.4	5.1
13- 18	31	4.6	0.3	4.1	4.5	5.0	
19- 24	2	39	5.0	0.3	4.2	4.9	5.6
25- 30	34	5.2	0.4	4.3	5.2	5.9	
31- 36	3	49	5.4	0.4	4.6	5.3	6.1
37- 42	131	5.5	0.4	4.8	5.4	6.2	
43- 48	4	123	5.6	0.4	4.9	5.5	6.3
49- 54	172	5.8	0.3	5.2	5.7	6.4	
55- 60	5	155	5.9	0.4	5.2	5.8	6.6
61- 66	125	6.2	0.4	5.5	6.1	6.9	
67- 72	6	94	6.3	0.4	5.5	6.2	6.9
73- 78	75	6.5	0.4	5.6	6.5	7.3	
79- 84	7	78	6.6	0.4	5.8	6.5	7.4
85- 96	8	134	6.9	0.5	5.9	6.8	7.7
97-108	9	130	7.1	0.5	6.2	7.0	7.8
109-120	10	107	7.3	0.4	6.5	7.2	8.0
121-132	11	98	7.6	0.5	6.7	7.5	8.6
133-144	12	55	8.0	0.5	7.1	7.8	8.8
145-156	13	21	8.0	0.7	7.0	7.8	9.1

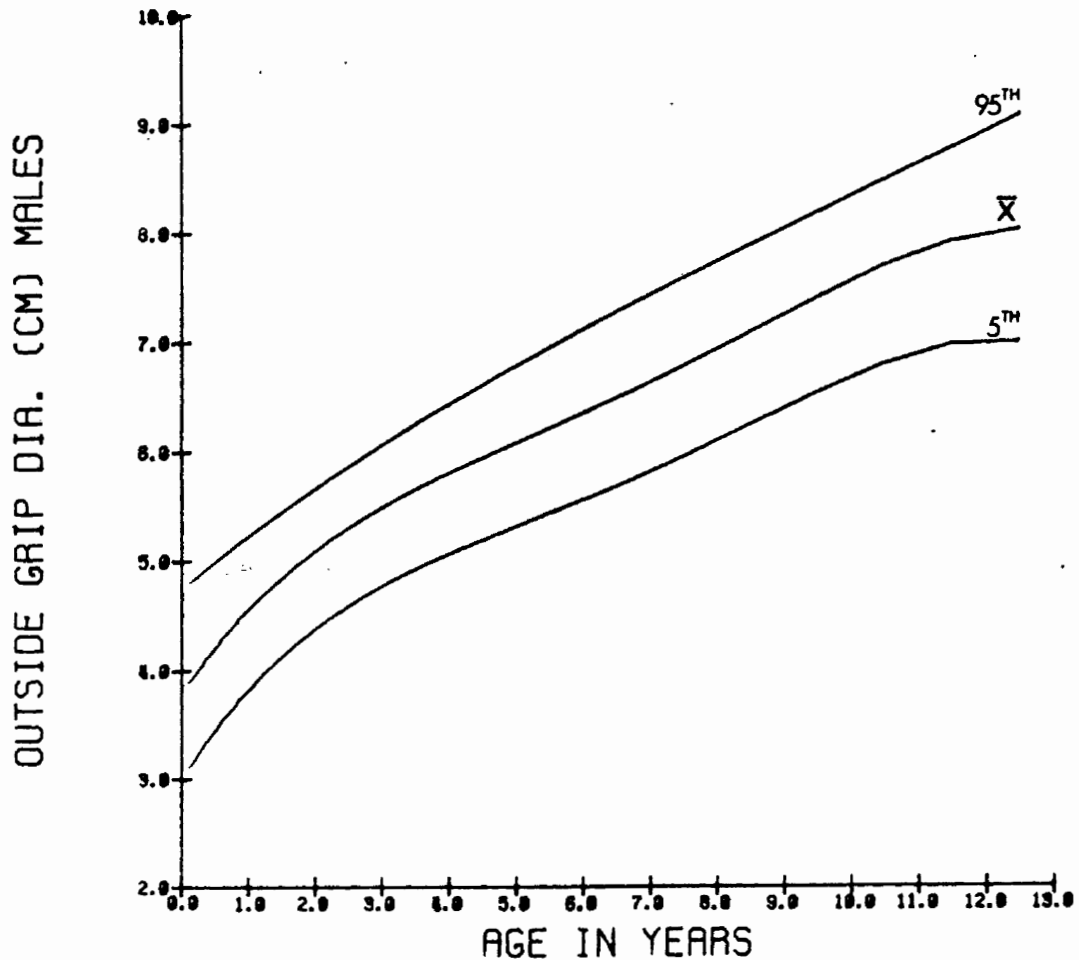

## HEAD BREADTH

Device: Automated sliding caliper. Measurements are recorded automatically by computer.

Description: INFANT: Infant lies on back. Measure the maximum breadth of the head above and behind the ears with the automated sliding caliper. The paddle-blades firmly contact the two body surfaces for measurement.

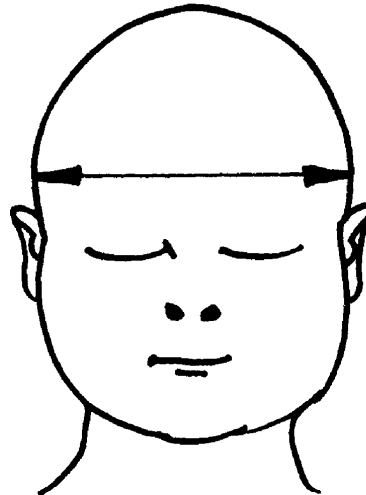

Description: CHILD: Child sits erect, arms hanging at side. Measure the maximum breadth of the head above and behind the ears with an automated sliding caliper. The paddle-blades firmly contact the two body surfaces for measurement.

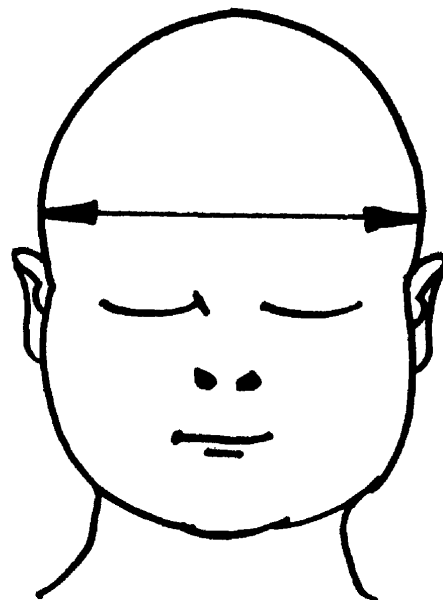

HEAD BREADTH, IN CMS. - COMBINED SEXES

AGE(MO/YRS)	N	MEAN	S.D.	5%	50%	95%	
0= 3	139	10.3	0.6	9.3	10.2	11.5	
4= 6	99	11.5	0.6	10.4	11.5	12.6	
7= 9	54	12.2	0.6	11.0	12.2	13.2	
10= 12	1	40	12.4	0.5	11.5	12.4	13.1
13= 18	53	12.7	0.5	11.8	12.6	13.5	
19= 24	2	71	13.1	0.4	12.4	13.1	14.0
25= 30	65	13.4	0.5	12.4	13.3	14.3	
31= 36	3	103	13.4	0.4	12.6	13.3	14.1
37= 42	271	13.5	0.5	12.6	13.5	14.2	
43= 48	4	293	13.6	0.4	12.8	13.6	14.4
49= 54	358	13.7	0.5	12.9	13.6	14.5	
55= 60	5	330	13.8	0.5	12.9	13.7	14.6
61= 66	243	13.8	0.4	12.9	13.7	14.6	
67= 72	6	175	13.9	0.4	13.1	13.8	14.7
73= 78	174	13.9	0.5	13.1	13.9	14.8	
79= 84	7	174	14.1	0.5	13.1	14.0	14.9
85= 96	8	283	14.1	0.5	13.3	14.0	14.9
97=108	9	276	14.2	0.5	13.4	14.2	15.0
109=120	10	261	14.3	0.5	13.4	14.2	15.1
121=132	11	206	14.4	0.4	13.6	14.3	15.2
133=144	12	112	14.5	0.5	13.6	14.4	15.4
145=156	13	53	14.6	0.4	13.7	14.5	15.3

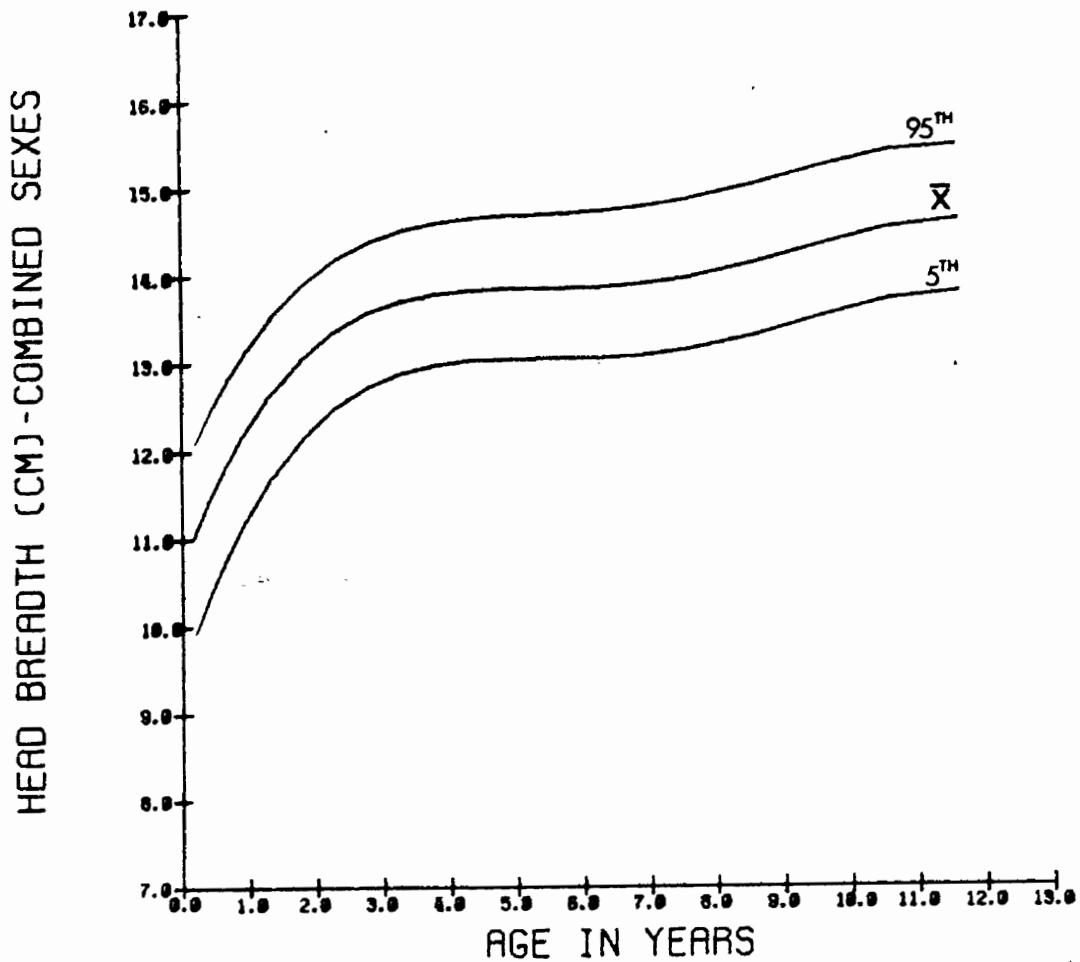

HEAD BREADTH, IN CMS. - FEMALES

AGE(MO/YRS)	N	MEAN	S.D.	5%	50%	95%	
0- 3	62	10.3	0.6	9.4	10.3	11.4	
4- 6	56	11.4	0.6	10.0	11.4	12.2	
7- 9	29	12.0	0.5	10.8	11.9	12.7	
10- 12	1	22	12.3	0.4	11.5	12.4	12.9
13- 18	23	12.5	0.3	12.0	12.3	13.1	
19- 24	2	30	13.0	0.5	11.9	12.8	13.8
25- 30	31	13.2	0.4	12.3	13.2	13.9	
31- 36	3	54	13.3	0.5	12.3	13.2	14.2
37- 42	141	13.4	0.5	12.5	13.3	14.2	
43- 48	170	13.5	0.4	12.7	13.5	14.2	
49- 54	186	13.6	0.4	12.7	13.5	14.2	
55- 60	175	13.6	0.4	12.7	13.6	14.3	
61- 66	118	13.6	0.5	12.8	13.6	14.4	
67- 72	82	13.7	0.4	13.0	13.6	14.4	
73- 78	99	13.8	0.5	13.0	13.7	14.7	
79- 84	96	13.9	0.4	13.0	13.9	14.6	
85- 96	147	14.0	0.4	13.2	13.9	14.7	
97-108	145	14.1	0.5	13.3	14.0	14.8	
109-120	153	14.2	0.5	13.2	14.1	15.0	
121-132	105	14.2	0.4	13.4	14.1	15.0	
133-144	58	14.5	0.6	13.4	14.4	15.5	
145-156	32	14.6	0.5	13.8	14.6	15.3	

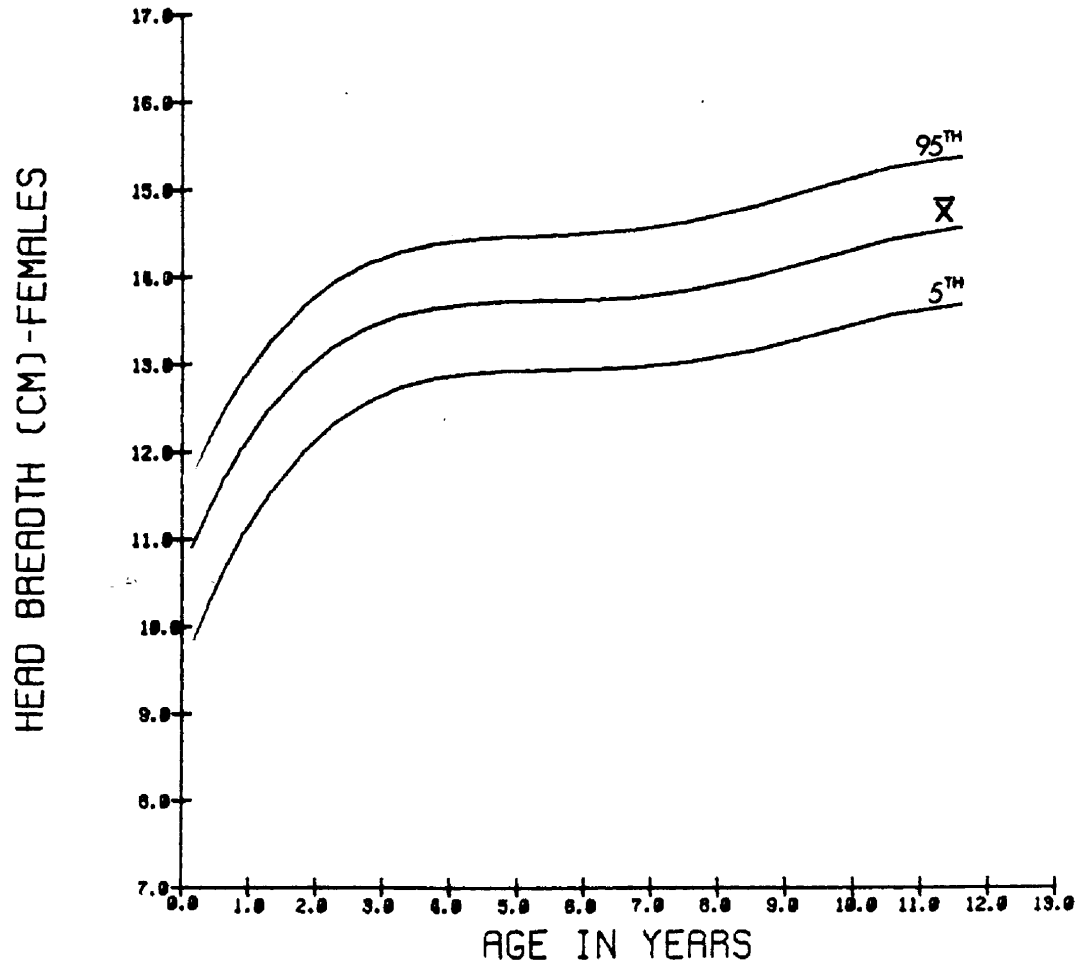

HEAD BREADTH, IN CMS. - MALES

AGE(MO/YRS)	N	MEAN	S.D.	5X	50X	95X	
0- 3	77	10.4	0.7	9.2	10.2	11.5	
4- 6	43	11.7	0.6	10.7	11.6	12.8	
7- 9	25	12.4	0.7	11.3	12.5	13.4	
10- 12	1	18	12.6	0.6	11.5	12.6	14.0
13- 18	30	12.9	0.5	11.8	12.8	13.6	
19- 24	2	41	13.3	0.4	12.5	13.2	14.0
25- 30	34	13.5	0.5	12.2	13.5	14.4	
31- 36	3	49	13.5	0.4	12.7	13.5	14.1
37- 42	130	13.6	0.4	12.8	13.6	14.3	
43- 48	4	123	13.8	0.4	13.0	13.7	14.6
49- 54	172	13.9	0.5	13.0	13.8	14.6	
55- 60	5	155	14.0	0.5	13.0	13.9	14.9
61- 66	125	14.0	0.4	13.3	13.9	14.6	
67- 72	6	93	14.0	0.4	13.2	14.0	14.8
73- 78	75	14.1	0.4	13.2	14.1	14.8	
79- 84	7	78	14.2	0.5	13.3	14.2	15.2
85- 96	8	136	14.2	0.5	13.4	14.1	15.1
97-108	9	131	14.3	0.4	13.6	14.2	15.1
109-120	10	108	14.4	0.5	13.5	14.4	15.1
121-132	11	101	14.6	0.4	13.8	14.6	15.3
133-144	12	54	14.5	0.5	13.7	14.3	15.4
145-156	13	21	14.5	0.4	13.7	14.5	15.1

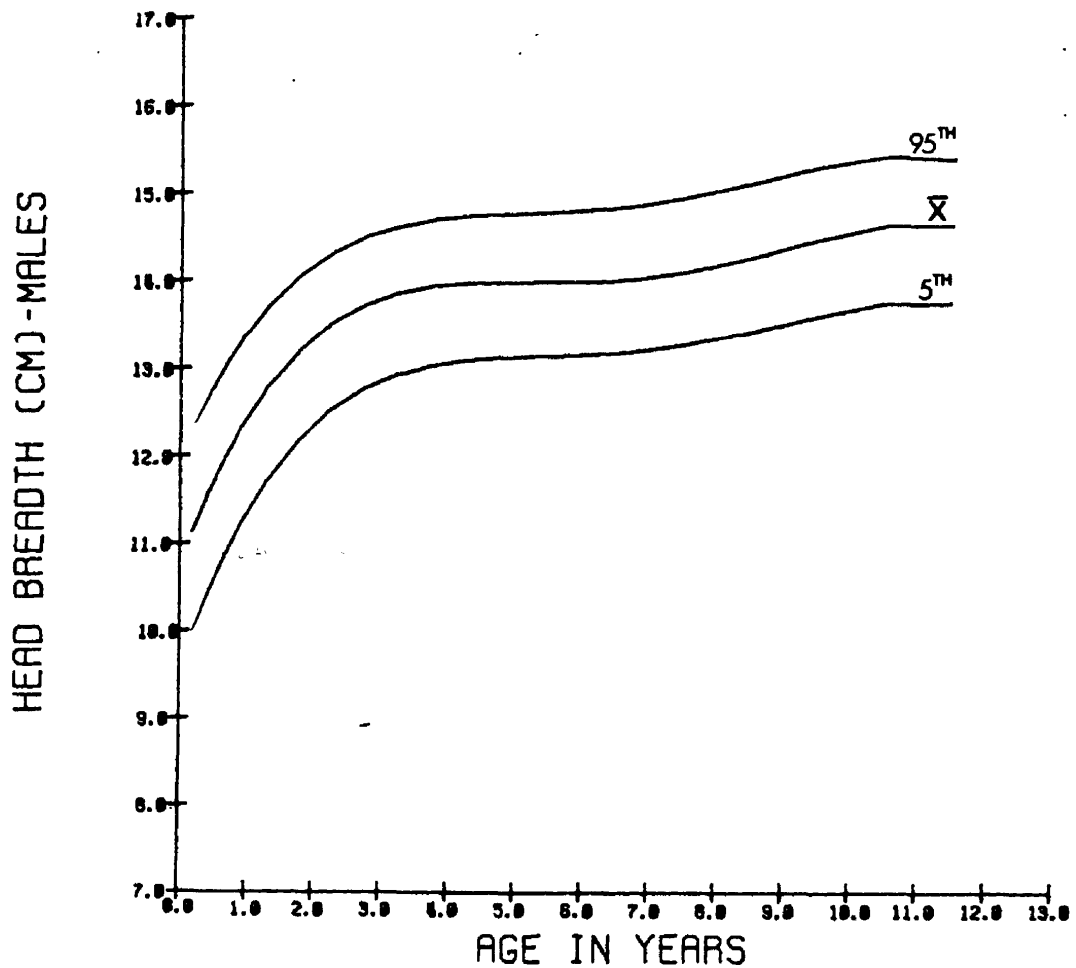

## SHOULDER BREADTH

Device: Automated anthropometer equipped with pressure transducer in paddle blade. Measurements are recorded automatically by computer at fixed pressure values.

Description: INFANT: Infant lies on back with arms held at side. Measure the maximum horizontal breadth across the shoulders with an automated anthropometer. Pressure is momentarily applied with the pressure-transducer paddle-blade. An assistant is required to assure that the infant is in the correct position.

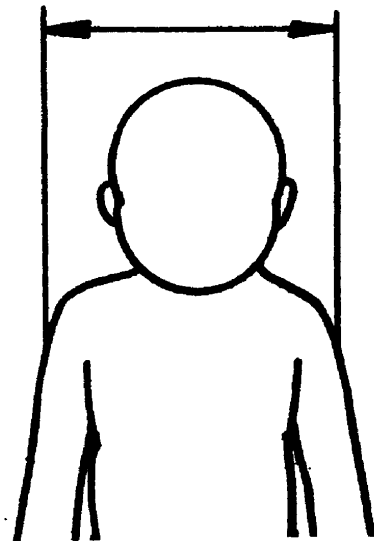
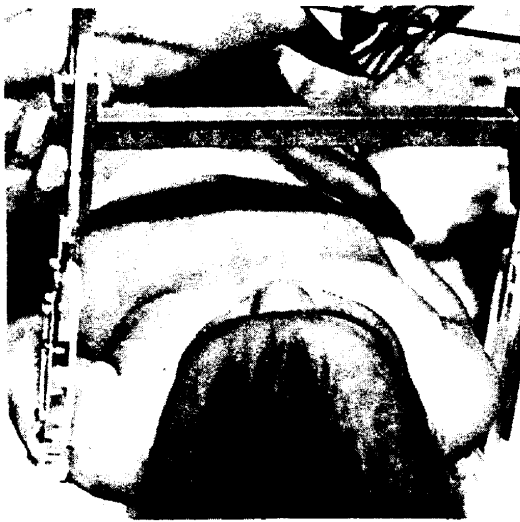

Description: CHILD: Child stands erect, arms hanging at side. Measure the maximum horizontal breadth across the shoulders with an automated anthropometer. Pressure is momentarily applied with the pressure transducer paddle-blade on either side.

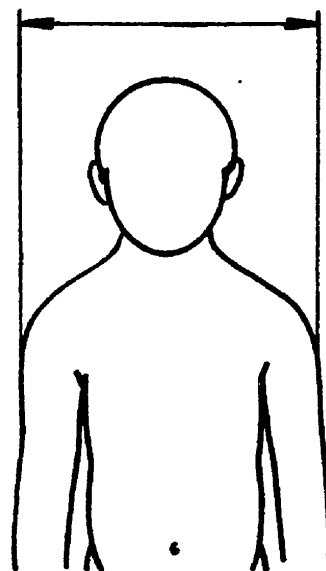

MAXIMUM SHOULDER BREADTH, IN CMS. - COMBINED SEXES

AGE(MO/YRS)	N	MEAN	S.D.	5%	50%	95%
0= 3	135	15.7	1.6	12.9	15.6	18.3
4= 6	97	18.7	1.4	16.1	18.7	20.7
7= 9	48	20.1	1.1	17.9	20.1	22.1
10= 12 1	36	20.5	1.1	18.7	20.2	22.4
13= 18	47	22.0	1.2	19.8	21.7	23.9
19= 24 2	63	22.7	1.3	20.1	22.7	25.0
25= 30	62	23.6	1.2	20.9	23.7	25.7
31= 36 3	100	24.2	1.3	22.0	24.1	26.4
37= 42	260	24.8	1.2	22.8	24.7	26.8
43= 48 4	282	25.1	1.3	22.9	24.9	27.2
49= 54	346	25.7	1.4	23.2	25.6	28.0
55= 60 5	325	26.3	1.5	23.7	26.2	28.4
61= 66	237	27.0	1.6	24.2	26.9	29.5
67= 72 6	170	27.5	1.6	25.0	27.3	30.3
73= 78	175	28.1	1.5	25.6	28.1	30.7
79= 84 7	169	28.7	1.7	25.8	28.6	31.7
85= 96 8	274	29.8	2.0	26.6	29.7	33.3
97=108 9	271	31.1	2.1	27.8	30.8	34.9
109=120 10	240	32.0	2.0	28.8	31.8	35.7
121=132 11	201	33.8	2.5	29.8	33.7	38.2
133=144 12	112	35.2	2.3	31.3	34.9	39.1
145=156 13	51	36.8	2.5	32.9	36.3	41.4

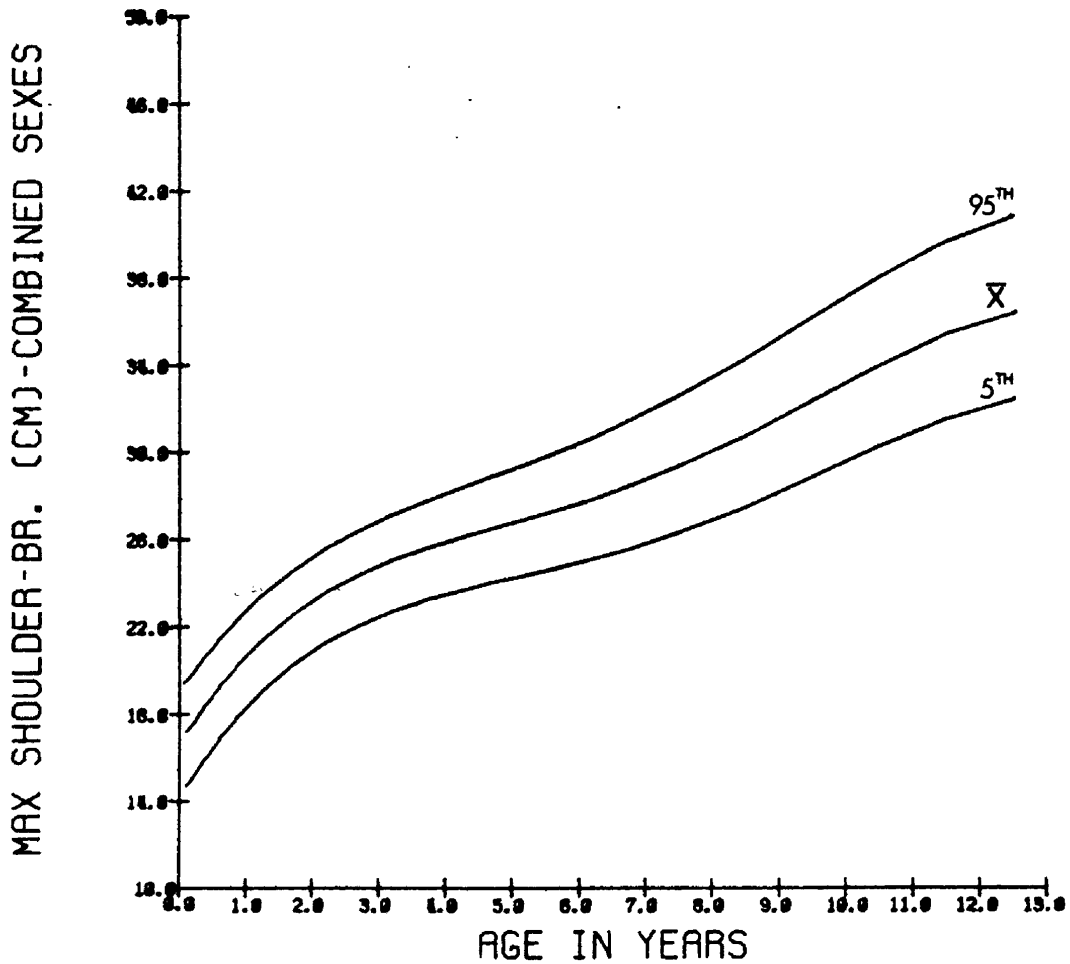



MAXIMUM SHOULDER BREADTH, IN CMS. - FEMALES

AGE(MO/YRS)	N	MEAN	S.D.	5%	50%	95%
0= 3	63	15.7	1.6	12.8	15.7	18.2
4= 6	55	18.3	1.4	15.7	18.3	20.5
7= 9	27	19.8	1.1	17.7	19.5	22.1
10= 12 1	21	20.3	1.1	18.7	19.9	22.3
13= 18	21	21.7	1.2	19.8	21.6	23.1
19= 24 2	29	22.7	1.4	19.3	22.8	24.7
25= 30	29	23.8	1.1	22.1	23.6	25.9
31= 36 3	52	23.9	1.2	22.0	23.8	25.7
37= 42	137	24.6	1.3	22.1	24.6	26.8
43= 48 4	163	24.9	1.3	22.9	24.8	27.1
49= 54	183	25.5	1.4	23.1	25.5	27.8
55= 60 5	171	26.0	1.5	23.4	26.1	28.1
61= 66	116	26.7	1.7	23.9	26.6	29.4
67= 72 6	81	27.3	1.5	24.6	27.1	29.8
73= 78	98	28.1	1.6	25.7	27.9	30.5
79= 84 7	92	28.4	1.7	25.5	28.4	30.8
85= 96 8	142	29.3	1.9	26.4	29.0	32.5
97=108 9	142	30.9	2.1	28.0	30.5	35.3
109=120 10	138	31.9	2.2	28.6	31.6	35.9
121=132 11	102	33.7	2.7	28.8	33.4	38.4
133=144 12	61	34.9	2.5	30.4	34.6	39.7
145=156 13	32	37.4	2.5	33.5	36.8	41.8

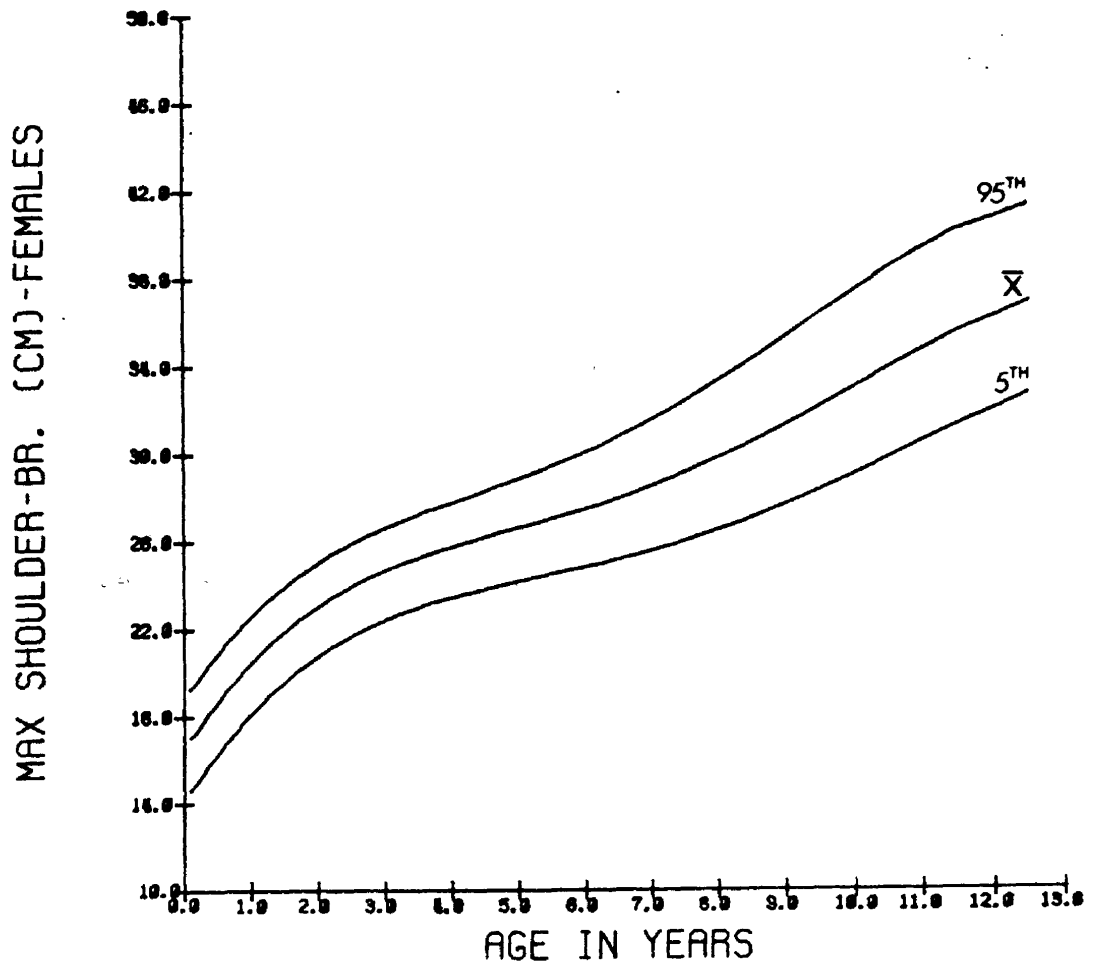

MAXIMUM SHOULDER BREADTH, IN CMS. - MALES

AGE(MO/YRS)	N	MEAN	S.D.	5%	50%	95%
0= 3	72	15.8	1.6	13.3	15.4	18.3
4= 6	42	19.1	1.1	16.4	19.1	20.8
7= 9	21	20.5	0.9	18.1	20.5	21.9
10= 12 1	15	20.7	1.1	18.9	20.7	22.5
13= 18	26	22.2	1.2	19.7	22.3	24.0
19= 24 2	34	22.7	1.3	20.4	22.6	25.0
25= 30	33	23.5	1.2	20.9	23.7	25.2
31= 36 3	48	24.5	1.5	21.0	24.7	26.7
37= 42	123	24.9	1.1	23.1	24.8	27.1
43= 48 4	119	25.3	1.3	23.0	25.4	27.3
49= 54	163	25.9	1.4	23.5	25.7	28.3
55= 60 5	154	26.5	1.4	23.8	26.3	29.0
61= 66	121	27.2	1.5	24.6	27.1	29.5
67= 72 6	89	27.8	1.6	25.2	27.5	30.6
73= 78	77	28.2	1.5	25.0	28.1	30.7
79= 84 7	77	29.2	1.6	27.1	28.9	31.9
85= 96 8	132	30.3	2.1	27.2	30.3	33.3
97=108 9	129	31.2	2.1	27.6	31.2	34.6
109=120 10	102	32.1	1.8	28.8	32.0	35.0
121=132 11	99	34.0	2.2	29.8	33.9	37.6
133=144 12	51	35.5	2.0	32.0	35.3	38.7
145=156 13	19	35.8	2.3	32.7	35.7	41.7

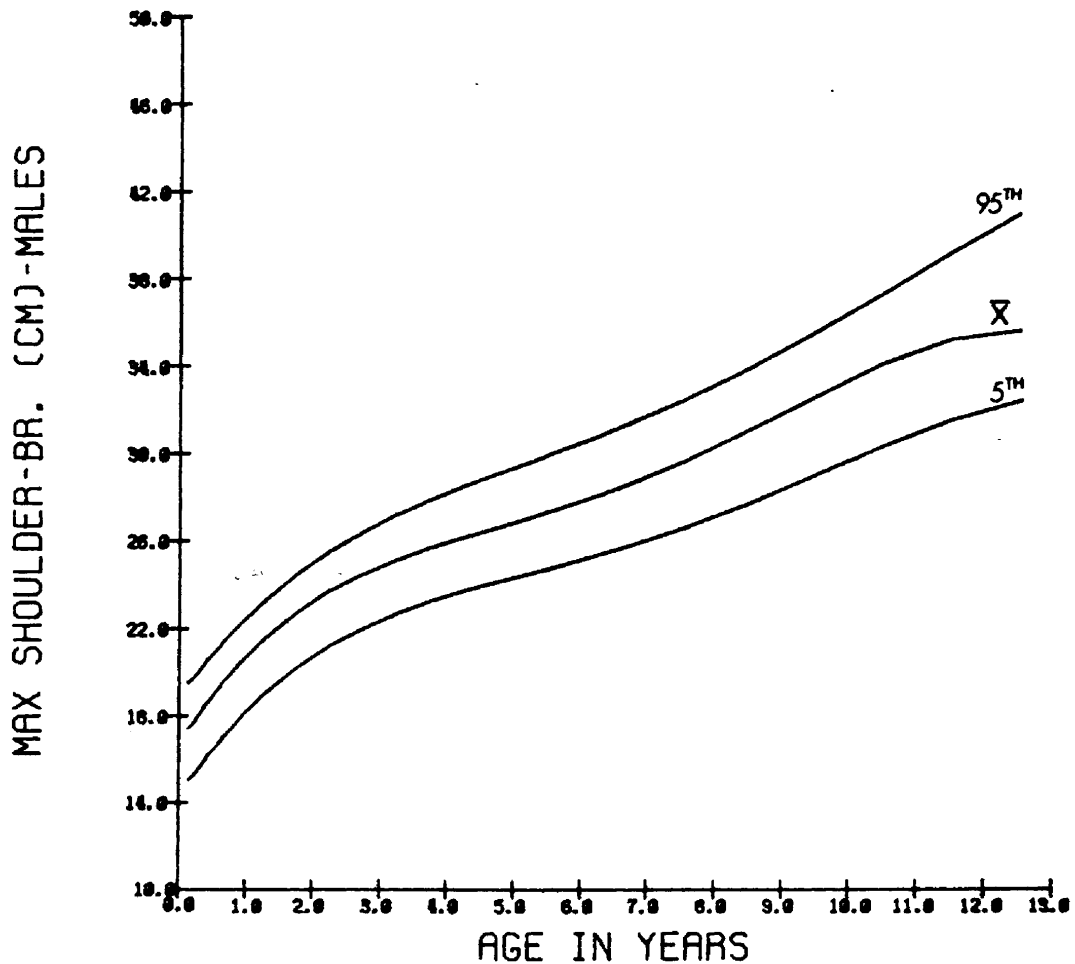

## CHEST BREADTH

Device: Automated anthropometer or sliding caliper equipped with pressure transducer in paddle blade. Measurements are recorded automatically by computer at fixed pressure values.

Description: INFANT: Infant lies on back. Measure the horizontal breadth of the chest at the level of the nipples with an automated anthropometer. Pressure is momentarily applied with the pressure-transducer paddle-blade. An assistant is required to assure that the infant is in the correct position.

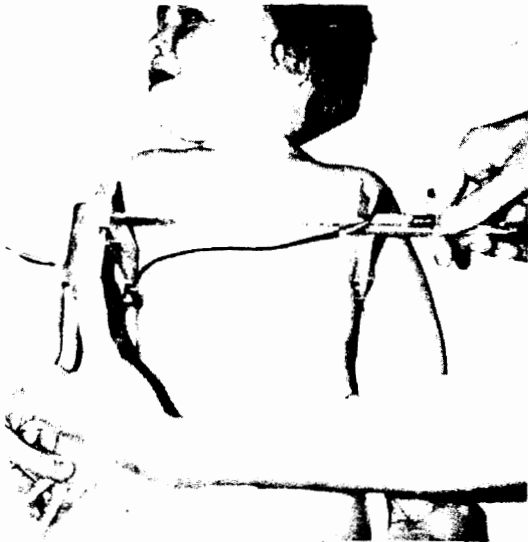

Description: CHILD: Child stands erect, arms hanging slightly away from sides. Measure the horizontal breadth of the chest at the level of the nipples with the pressure transducer paddle-blade on either side.

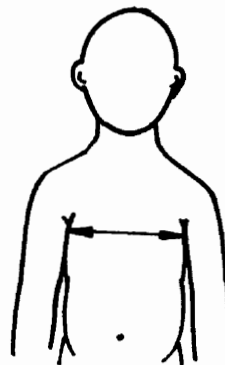

CHEST BREADTH, IN CHS. - COMBINED SEXES

AGE(MO/YRS)	N	MEAN	S.D.	5X	50X	95X
0= 3	135	11.6	1.2	9.6	11.4	13.7
4= 6	97	13.7	0.9	12.1	13.6	15.2
7= 9	49	14.8	0.7	13.1	15.0	15.7
10= 12 1	36	15.3	0.9	13.5	15.1	16.8
13= 18	47	16.0	0.8	14.6	16.0	17.4
19= 24 2	63	16.4	1.2	14.7	16.4	17.7
25= 30	63	17.0	0.8	15.6	16.9	18.4
31= 36 3	100	17.2	1.0	15.6	17.0	19.1
37= 42	260	17.4	0.8	16.0	17.4	18.8
43= 48 4	282	17.6	0.8	16.1	17.6	19.0
49= 54	347	18.0	0.9	16.3	18.0	19.5
55= 60 5	327	18.3	1.0	16.7	18.2	20.0
61= 66	237	18.7	1.0	16.9	18.6	20.4
67= 72 6	172	19.0	1.0	17.5	18.9	21.0
73= 78	174	19.3	1.1	17.5	19.2	21.2
79= 84 7	170	19.8	1.3	17.3	19.7	22.2
85= 96 8	273	20.3	1.4	18.0	20.2	22.8
97=108 9	270	21.1	1.4	19.1	20.9	23.7
109=120 10	235	21.6	1.5	19.5	21.4	24.1
121=132 11	193	22.6	1.7	20.2	22.4	25.0
133=144 12	105	23.5	1.7	20.7	23.6	26.4
145=156 13	47	24.4	1.9	21.9	24.1	28.4

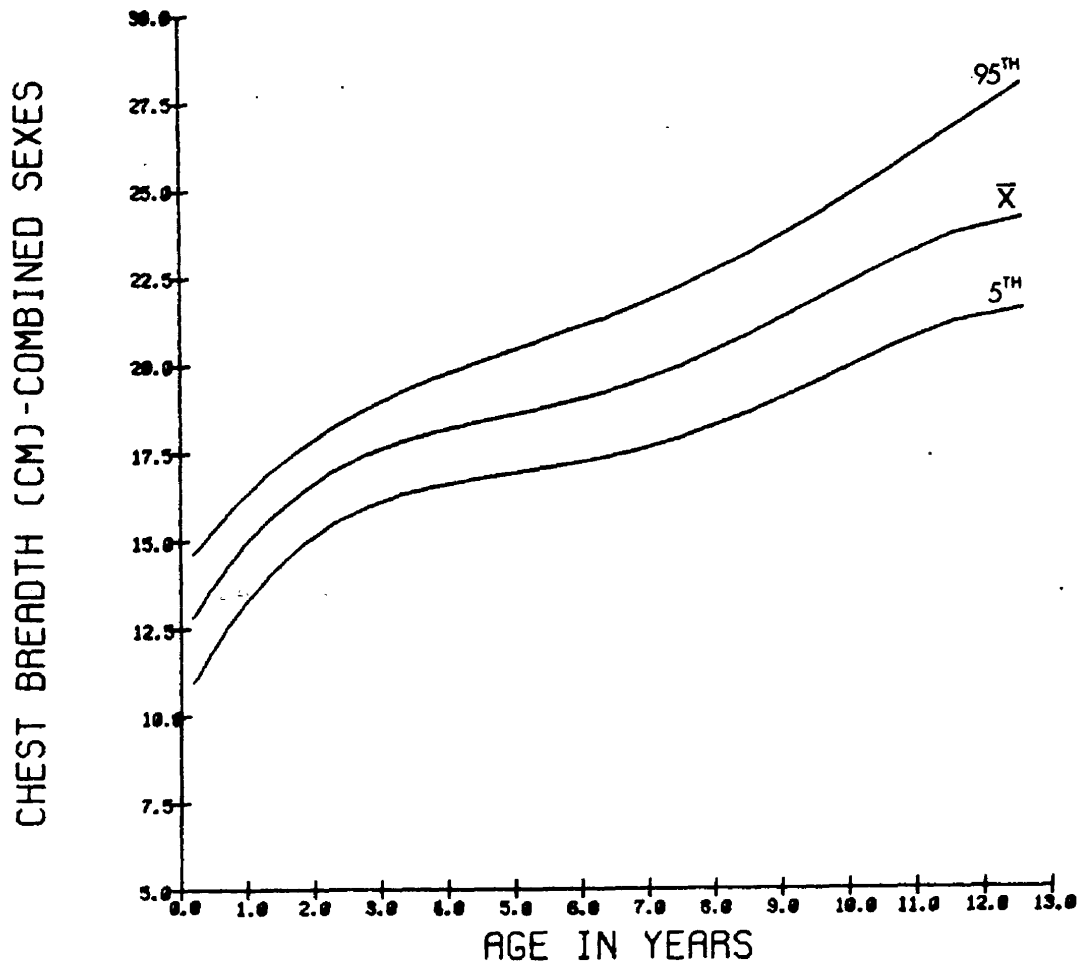

CHEST BREADTH, IN CMS, - FEMALES

AGE(MO/YRS)	N	MEAN	S.D.	5%	50%	95%
0= 3	63	11.5	1.1	9.7	11.3	13.4
4= 6	55	13.5	0.9	12.0	13.5	15.0
7= 9	27	14.6	0.7	13.1	14.6	15.6
10= 12 1	21	15.1	0.9	13.2	15.0	16.6
13= 18	20	16.0	0.8	14.6	15.9	18.2
19= 24 2	29	16.3	1.6	14.1	16.3	17.4
25= 30	30	16.8	0.7	15.7	16.8	18.2
31= 36 3	52	17.0	0.9	15.5	16.8	18.5
37= 42	137	17.2	0.8	15.8	17.2	18.6
43= 48 4	163	17.5	0.8	16.0	17.4	18.9
49= 54	163	17.8	0.8	16.2	17.8	19.0
55= 60 5	173	18.1	0.9	16.4	18.0	19.6
61= 66	116	18.4	1.0	16.7	18.4	20.1
67= 72 6	81	18.7	0.9	17.0	18.5	20.5
73= 78	97	19.1	1.1	17.3	18.9	21.1
79= 84 7	93	19.4	1.3	17.1	19.4	21.8
85= 96 8	140	19.8	1.3	17.8	19.5	22.1
97=108 9	140	20.9	1.5	18.9	20.7	23.4
109=120 10	133	21.4	1.5	19.3	21.1	24.3
121=132 11	94	22.2	1.9	19.1	22.0	25.0
133=144 12	53	23.1	1.7	19.7	23.1	25.9
145=156 13	28	24.8	2.0	21.6	24.4	28.7

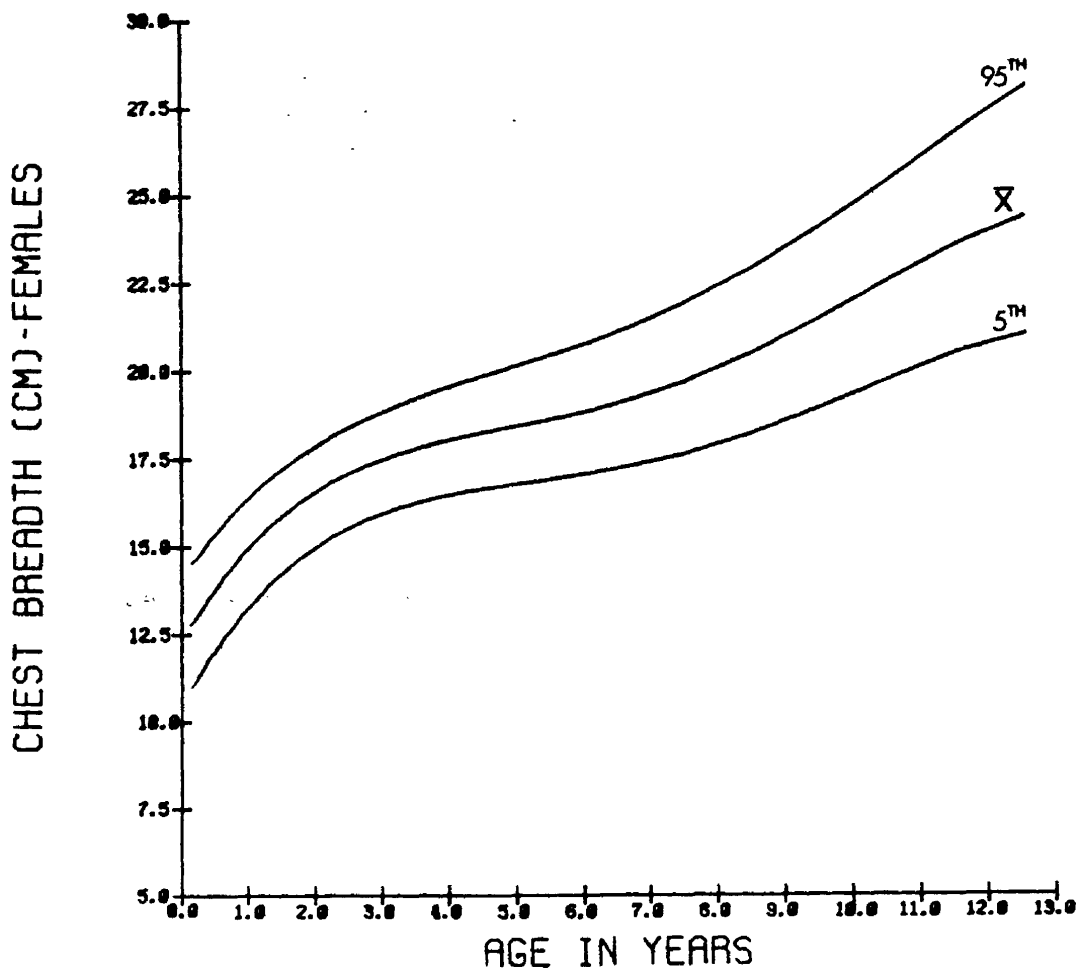

CHEST BREADTH, IN CMS, - MALES

AGE(MO/YRS)	N	MEAN	S.D.	5%	50%	95%
0= 3	72	11.6	1.3	9.0	11.7	13.8
4= 6	42	14.0	0.8	12.4	13.9	15.2
7= 9	22	15.1	0.7	13.6	15.2	15.9
10= 12 1	15	15.5	0.8	14.3	15.2	17.0
13= 18	27	16.1	0.7	14.2	16.0	17.2
19= 24 2	34	16.5	0.9	14.6	16.5	17.7
25= 30	33	17.1	0.9	15.1	17.1	18.4
31= 36 3	48	17.5	1.0	15.7	17.2	19.2
37= 42	123	17.6	0.8	16.1	17.7	19.0
43= 48 4	119	17.9	0.8	16.3	17.9	19.4
49= 54	164	18.2	1.0	16.6	18.1	19.7
55= 60 5	154	18.5	1.0	16.8	18.4	20.3
61= 66	121	18.9	1.0	17.2	19.0	20.5
67= 72 6	91	19.3	1.1	17.6	19.3	21.2
73= 78	77	19.6	1.0	18.0	19.4	21.3
79= 84 7	77	20.2	1.3	17.9	19.9	22.5
85= 96 8	133	20.7	1.4	18.3	20.5	23.3
97=108 9	130	21.4	1.4	19.3	21.2	23.7
109=120 10	102	21.9	1.4	20.1	21.9	23.9
121=132 11	99	23.0	1.3	21.0	22.7	25.1
133=144 12	52	23.9	1.6	21.1	23.9	26.5
145=156 13	19	24.0	1.6	22.1	23.5	28.6

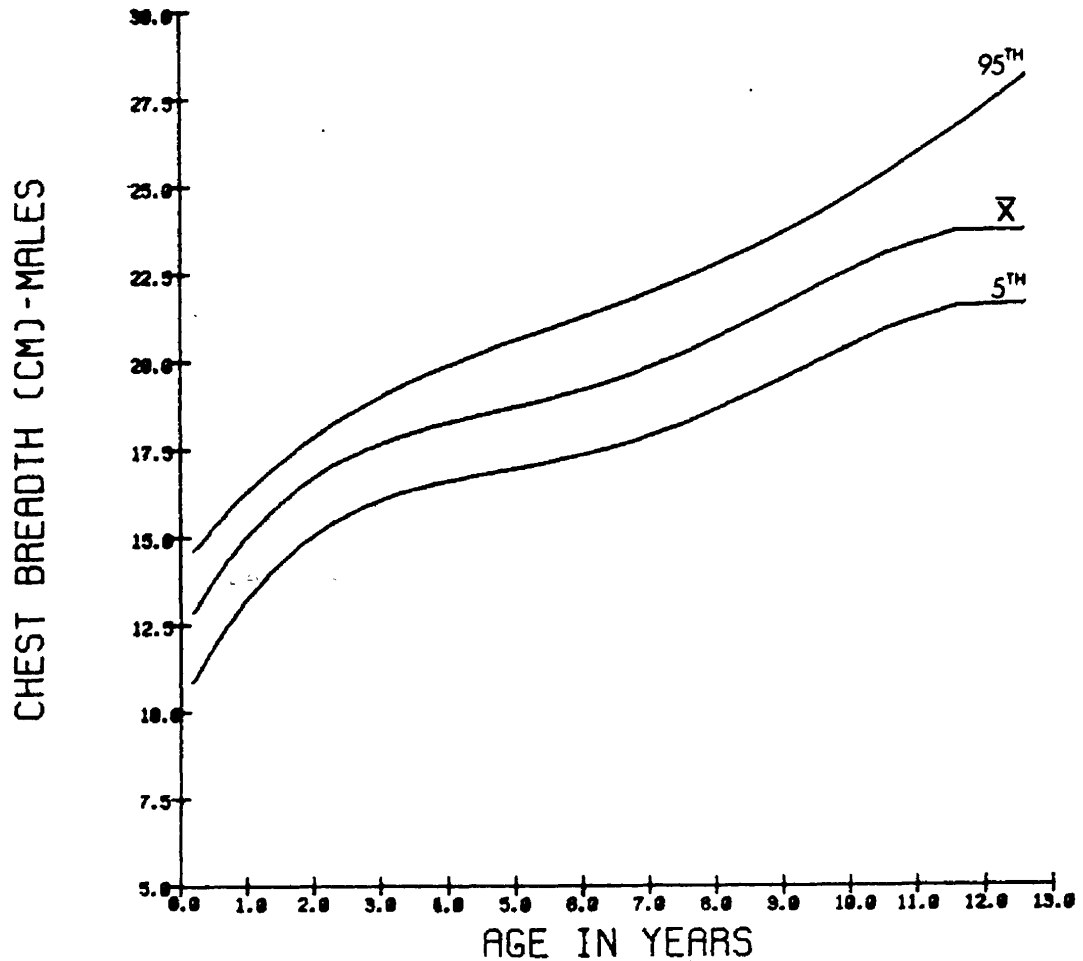

## WAIST BREADTH

Device: Automated anthropometer or sliding caliper equipped with pressure transducer in paddle blade. Measurements are recorded automatically by computer at fixed pressure values.

Description: INFANT: Infant lies on back with legs fully extended. Measure the minimum breadth just below the level of the iliac crest and above the level of the greater trochanter with an automated anthropometer. Pressure is momentarily applied with the pressure-transducer paddle blade on either side of the hips. An assistant is required to assure that the infant is in the correct position.



Description: CHILD: Child stands erect, arms hanging at side. Measure the maximum breadth at the level of the natural waist with an automated anthropometer. Pressure is momentarily applied with pressure-transducer paddle-blade on either side of the subject.

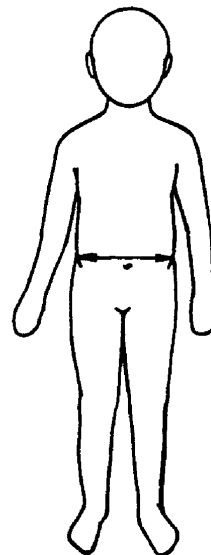

WAIST BREADTH, IN CMS. - COMBINED SEXES

AGE(MO/YRS)	N	MEAN	S.D.	5%	50%	95%
0= 3	133	10.4	1.1	8.5	10.2	12.3
4= 6	94	12.3	1.0	10.8	12.3	13.9
7= 9	49	13.1	1.0	11.3	13.3	14.7
10= 12 1	34	13.2	1.0	11.5	13.1	14.6
13= 18	45	13.9	0.9	12.1	13.9	15.4
19= 24 2	62	14.6	1.2	12.7	14.6	16.2
25= 30	63	15.2	0.9	13.3	15.2	16.5
31= 36 3	100	15.1	1.1	13.0	15.1	16.9
37= 42	257	15.2	1.4	12.6	15.3	17.4
43= 48 4	283	15.2	1.4	12.6	15.3	17.2
49= 54	347	15.6	1.5	12.4	15.6	17.6
55= 60 5	324	15.8	1.6	12.5	16.0	18.0
61= 66	234	16.1	1.6	12.9	16.2	18.3
67= 72 6	167	16.3	1.8	13.4	16.4	18.8
73= 78	171	16.3	1.7	12.2	16.5	18.5
79= 84 7	170	16.9	1.7	13.8	17.1	19.3
85= 96 8	269	17.3	2.1	13.4	17.3	20.5
97=108 9	272	18.0	1.9	14.3	18.1	20.8
109=120 10	240	18.5	2.0	14.8	18.5	21.7
121=132 11	198	19.6	1.9	16.0	19.5	22.8
133=144 12	111	20.0	2.0	17.1	19.7	23.2
145=156 13	51	20.5	2.3	16.0	20.2	24.2

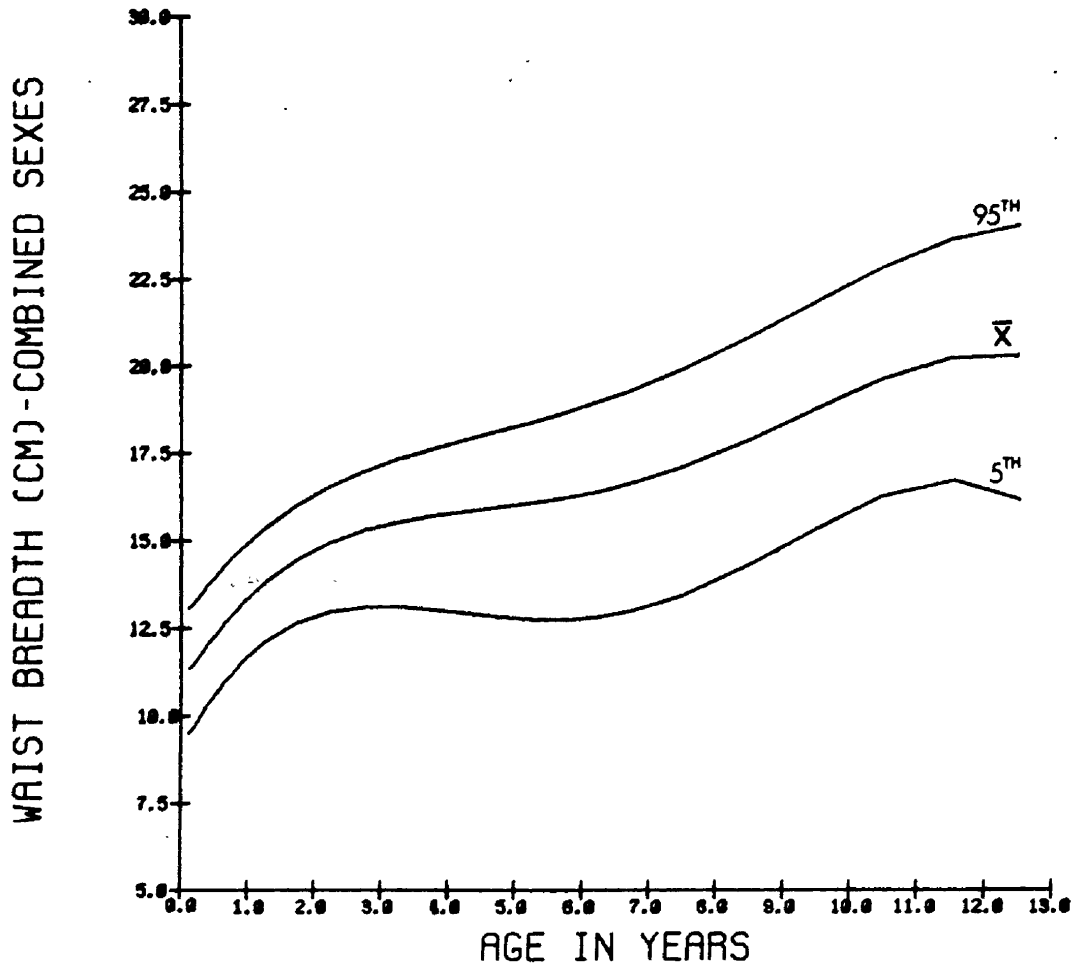



WAIST BREADTH, IN CMS. - FEMALES

AGE(MO/YRS)	N	MEAN	S.D.	5%	50%	95%	
0= 3	61	10.4	1.2	8.6	10.2	12.6	
4= 6	52	12.2	1.0	10.6	12.1	13.8	
7= 9	27	12.9	1.0	10.7	12.7	14.5	
10= 12	1	20	13.1	1.1	10.9	12.9	15.3
13= 18	19	13.8	0.9	11.8	13.8	15.8	
19= 24	2	29	14.3	1.5	10.1	14.4	16.3
25= 30	30	15.0	0.8	13.5	14.9	16.2	
31= 36	3	53	14.8	1.1	12.7	14.7	16.7
37= 42	137	15.0	1.4	12.3	15.0	17.2	
43= 48	4	164	15.0	1.4	12.2	15.1	17.0
49= 54	182	15.2	1.5	12.1	15.5	17.4	
55= 60	5	172	15.5	1.5	12.2	15.8	17.5
61= 66	113	15.7	1.7	12.3	16.0	17.9	
67= 72	6	79	16.1	1.8	12.0	15.9	18.7
73= 78	97	16.5	1.5	12.4	16.5	18.7	
79= 84	7	93	16.5	1.6	13.3	16.6	18.9
85= 96	8	139	16.8	2.0	12.9	16.9	19.7
97=108	9	141	17.7	1.9	14.1	17.9	20.4
109=120	17	140	18.2	2.0	14.7	18.2	21.8
121=132	11	101	19.3	1.9	15.9	19.3	22.7
133=144	12	60	19.7	1.9	16.7	19.6	23.3
145=156	13	32	20.4	2.4	15.3	20.3	24.1

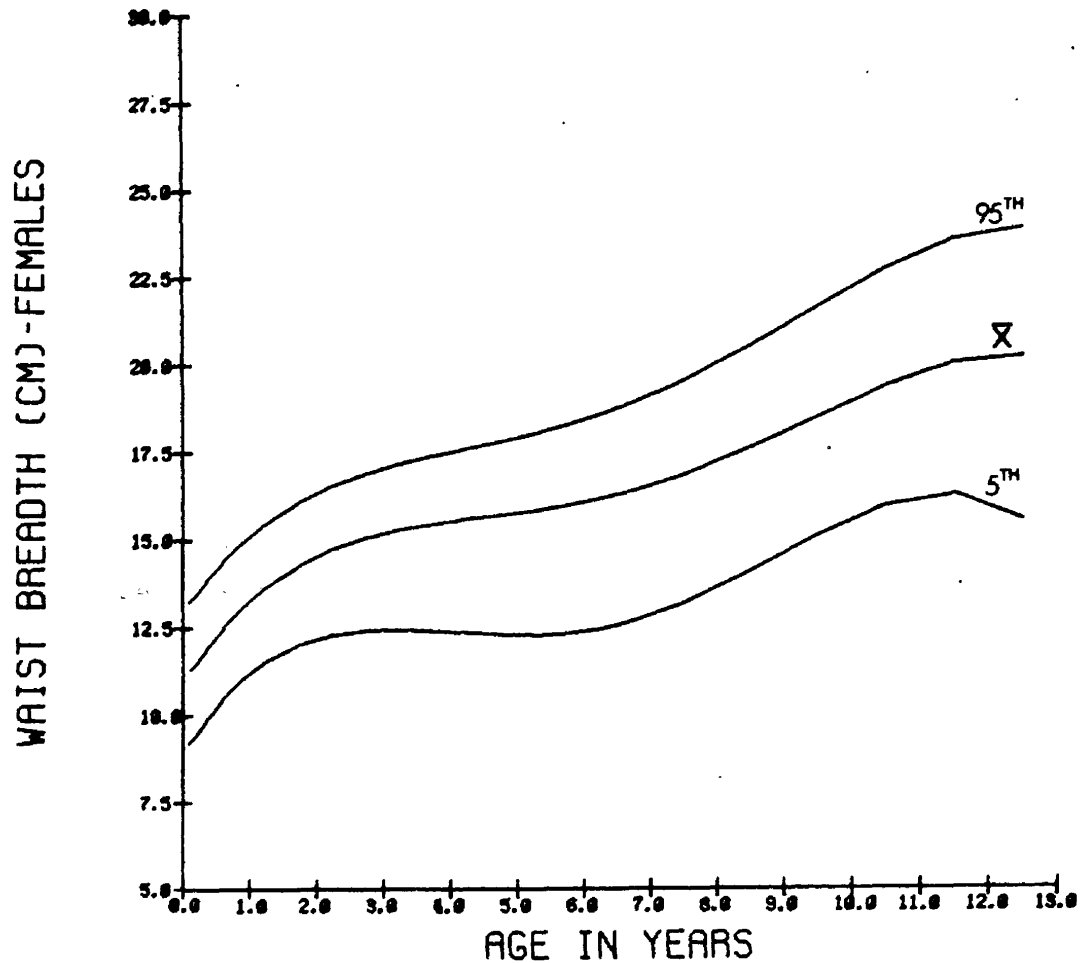

WAIST BREADTH, IN CMS, - MALES

AGE (MO/YRS)	N	MEAN	S.D.	5%	50%	95%	
0= 3	72	10.4	1.1	8.3	10.2	12.1	
4= 6	42	12.6	0.9	11.1	12.5	14.1	
7= 9	22	13.4	0.8	11.7	13.6	14.5	
10= 12	1	13.4	0.7	12.2	13.1	14.6	
13= 18	26	14.0	0.9	12.1	14.0	15.4	
19= 24	2	33	14.8	0.9	13.1	14.7	16.1
25= 30	33	15.4	1.0	12.8	15.4	16.7	
31= 36	3	47	15.4	1.1	13.3	15.3	17.0
37= 42	120	15.5	1.3	13.3	15.6	17.5	
43= 48	4	119	15.5	1.3	12.8	15.6	17.5
49= 54	165	15.9	1.4	13.2	16.0	17.7	
55= 60	5	152	16.1	1.5	12.8	16.2	18.1
61= 66	121	16.4	1.4	13.6	16.5	18.5	
67= 72	6	88	16.6	1.7	13.7	16.5	18.8
73= 78	74	16.2	1.9	12.1	16.5	18.5	
79= 84	7	77	17.5	1.7	13.7	17.5	19.8
85= 96	8	130	17.8	2.0	13.7	17.9	21.5
97=100	9	131	18.3	1.9	14.4	18.5	21.0
109=120	10	100	18.8	1.9	15.0	18.9	21.7
121=132	11	97	19.8	1.9	16.1	19.8	22.8
133=144	12	51	20.3	2.1	17.2	19.9	23.2
145=156	13	19	20.6	2.1	17.0	20.1	25.2

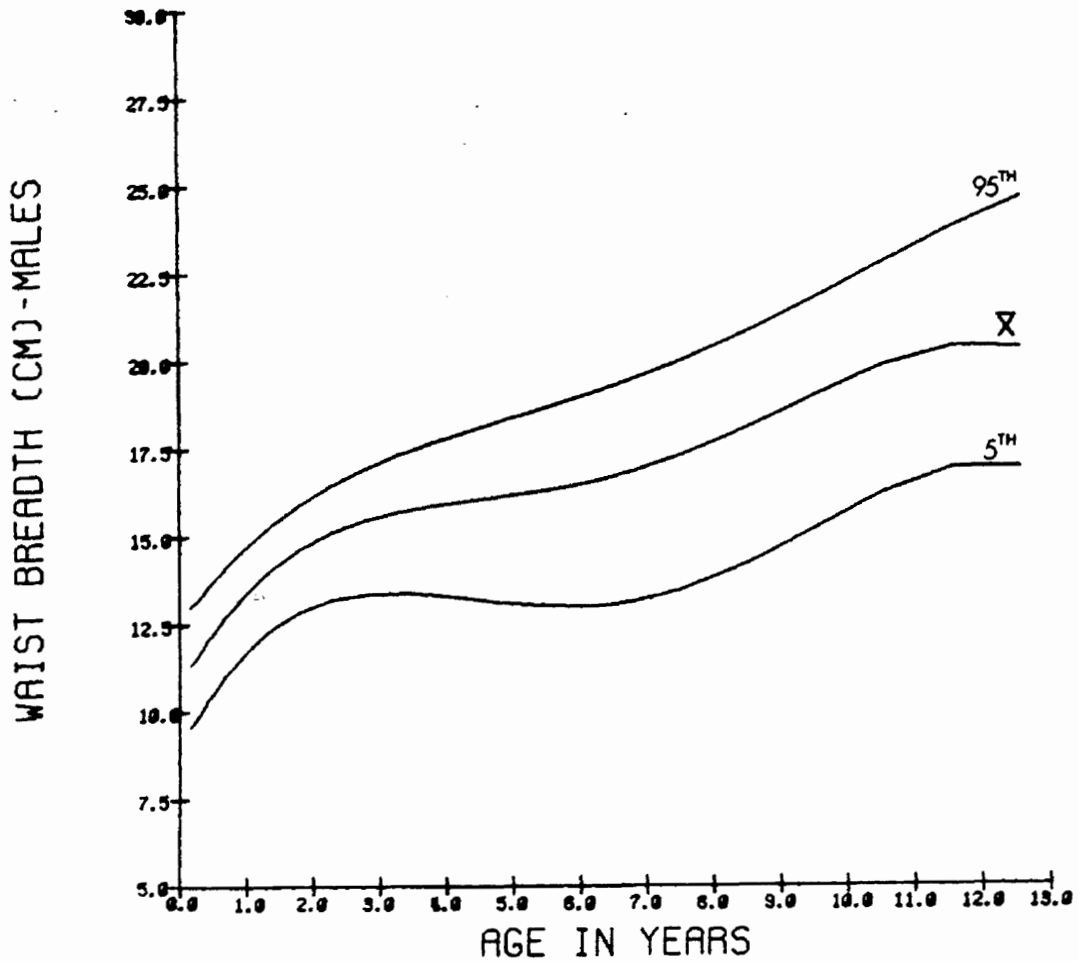

## LOWER TORSO BREADTH

Device: Automated anthropometer or sliding caliper equipped with pressure transducer in paddle blade. Measurements are recorded automatically by computer at fixed pressure values.

Description: INFANT: Infant lies on back with legs fully extended. Measure the maximum breadth below the minimum breadth of the torso (this measurement is usually taken at the approximate level of the crotch and ischial tuberosities) with an automated anthropometer. Pressure is momentarily applied with the pressure-transducer paddle-blade on the upper thigh. An assistant is required to assure that the infant is in the correct position.

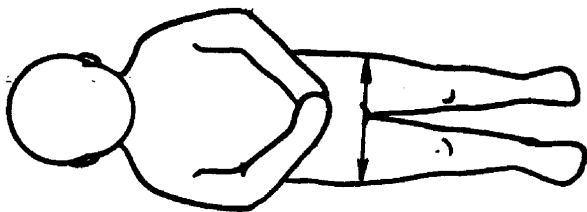

## LOWER TORSO BREADTH

Device: Automated anthropometer or sliding caliper equipped with pressure transducer in paddle blade. Measurements are recorded automatically by computer at fixed pressure values.

Description: CHILD: Child stands erect, arms hanging at side. Measure the maximum horizontal breadth at the level of the upper thigh with an automated anthropometer. Pressure is applied momentarily with the pressure-transducer paddle-blade on either the left or right surface.

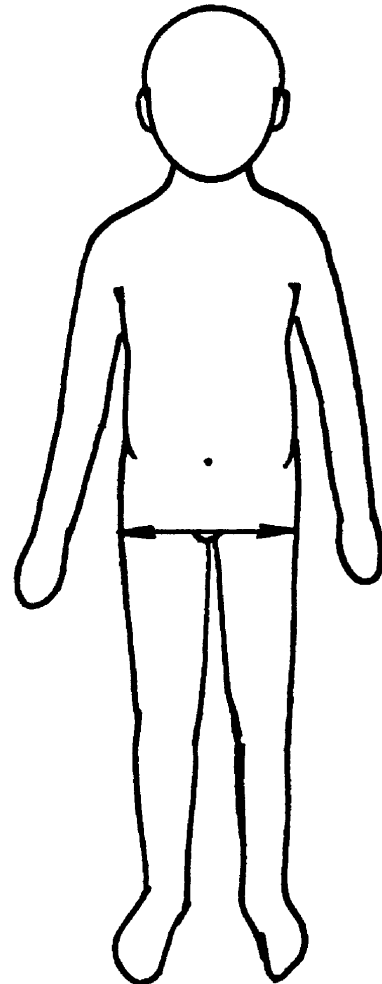

LOWER TORSO BREADTH, IN CMS. • COMBINED SEXES

AGE(MO/YRS)	N	MEAN	S.D.	5%	50%	95%
0= 3	132	11.6	1.5	8.9	11.7	13.6
4= 6	94	14.2	1.1	12.3	14.2	16.4
7= 9	44	14.8	1.1	13.0	14.6	16.7
10= 12 1	34	14.9	1.0	13.1	14.9	16.5
13= 18	43	15.8	1.0	13.8	15.6	17.3
19= 24 2	61	16.6	1.2	14.4	16.5	18.3
25= 30	60	17.1	1.1	15.1	16.9	18.9
31= 36 3	98	17.3	1.1	15.5	17.2	19.3
37= 42	255	17.6	1.2	15.5	17.5	19.6
43= 48 4	275	17.8	1.1	16.0	17.8	19.7
49= 54	329	18.2	1.1	16.4	18.2	20.0
55= 60 5	319	18.7	1.2	16.6	18.6	20.9
61= 66	229	19.2	1.3	16.9	19.2	21.2
67= 72 6	165	19.7	1.4	17.5	19.6	21.9
73= 78	165	20.0	1.4	17.7	20.1	22.3
79= 84 7	161	20.6	1.3	18.5	20.5	22.8
85= 96 8	245	21.4	1.7	18.9	21.1	24.2
97=108 9	246	22.5	1.7	20.0	22.2	25.4
109=120 10	209	23.3	1.6	20.5	23.2	25.8
121=132 11	182	24.8	2.1	21.7	24.6	28.3
133=144 12	97	26.0	2.0	23.3	25.8	29.8
145=156 13	47	27.8	2.2	24.5	27.7	31.2

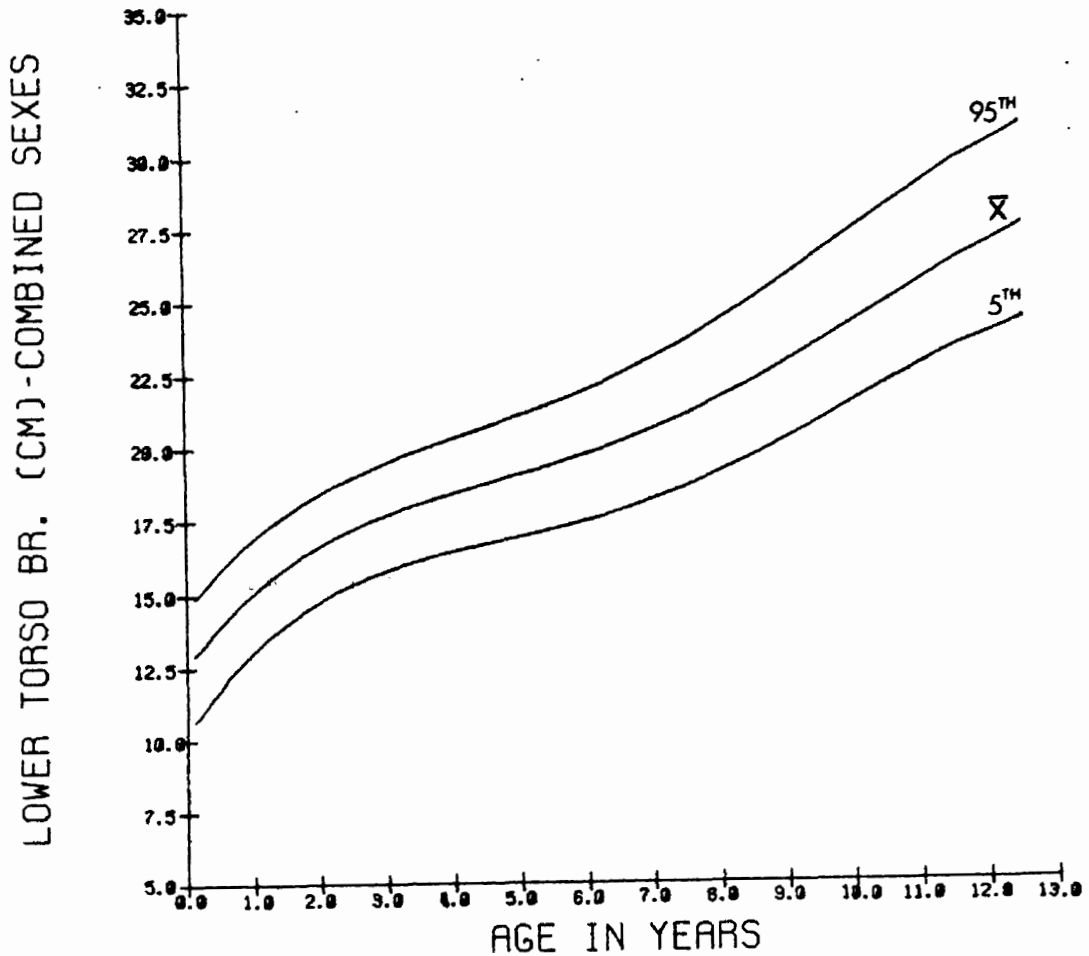

LOWER TORSO BREADTH, IN CMS. - FEMALES

AGE (MO/YRS)	N	MEAN	S.D.	5%	50%	95%
0= 3	60	11.6	1.5	8.8	11.7	13.5
4= 6	52	14.1	1.2	11.7	14.1	16.4
7= 9	24	14.6	1.1	12.4	14.3	16.5
10= 12 1	19	14.6	1.1	13.1	14.4	16.8
13= 18	18	15.7	1.1	13.8	15.5	17.9
19= 24 2	28	16.3	1.3	13.1	16.5	17.6
25= 30 3	29	17.0	1.1	15.3	16.7	18.9
31= 36 3	51	17.3	1.2	15.5	17.1	19.3
37= 42 4	137	17.6	1.2	15.4	17.4	19.7
43= 48 4	162	17.9	1.1	16.0	17.9	19.7
49= 54 5	179	18.3	1.1	16.6	18.3	20.0
55= 60 5	170	18.7	1.2	16.7	18.6	21.2
61= 66 6	117	19.3	1.4	16.9	19.2	21.2
67= 72 6	78	19.8	1.3	17.7	19.7	22.0
73= 78 7	97	20.2	1.4	17.7	20.2	22.9
79= 84 7	89	20.6	1.2	18.5	20.4	22.7
85= 96 8	133	21.4	1.6	19.1	21.1	24.3
97=108 9	140	22.8	1.8	20.1	22.5	26.1
109=120 10	131	23.6	1.6	21.0	23.4	26.4
121=132 11	98	25.1	2.1	21.7	25.1	28.8
133=144 12	55	26.3	2.2	23.2	26.4	30.4
145=156 13	31	28.7	1.9	25.0	28.5	31.5

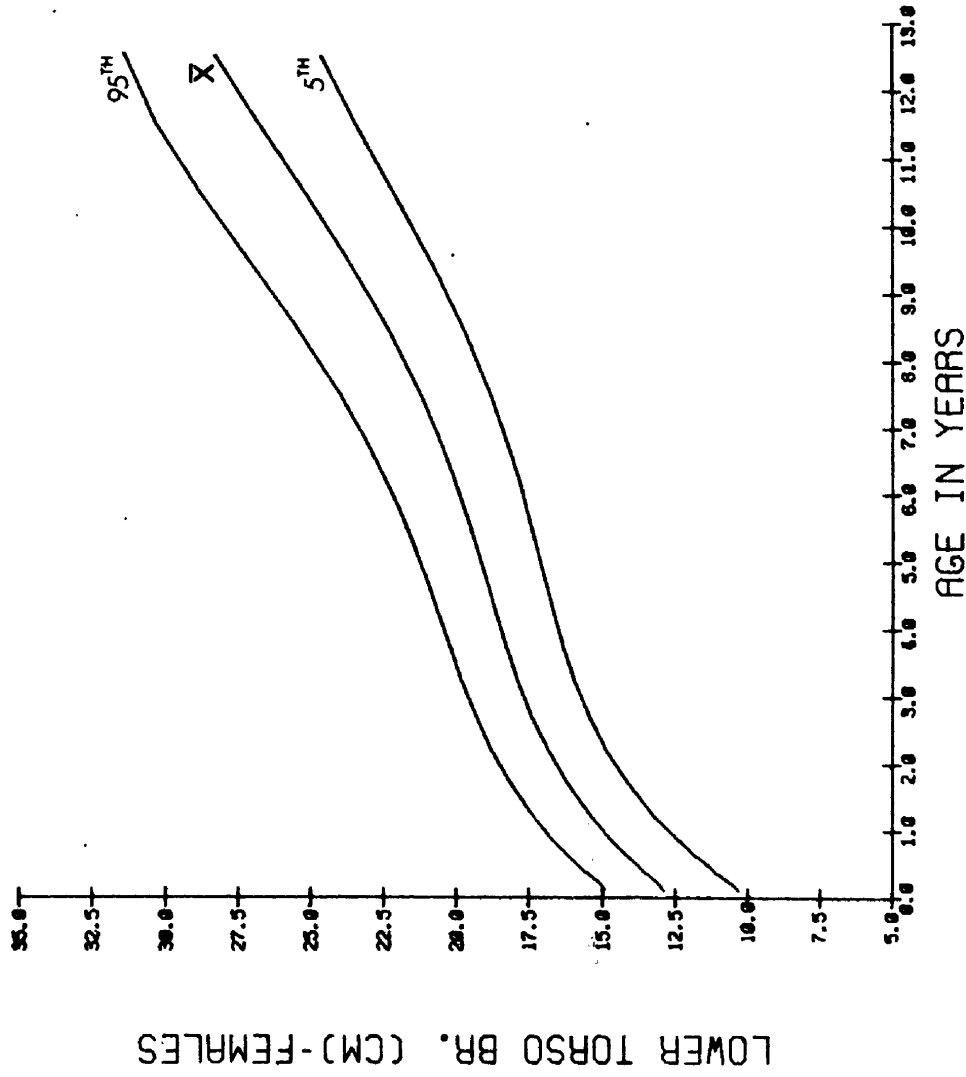

LOWER TORSO BREADTH, IN CMS. - MALES

AGE (MO/YRS)	N	MEAN	S.D.	5%	50%	95%
0= 3	72	11.6	1.5	8.9	11.3	13.7
4= 6	42	14.4	1.1	12.4	14.3	15.9
7= 9	20	14.9	1.1	13.0	14.7	17.6
10= 12 1	15	15.2	1.0	13.8	15.0	18.1
13= 18	25	15.8	1.0	13.8	15.7	17.3
19= 24 2	33	16.8	1.1	15.3	16.5	18.6
25= 30	31	17.1	1.1	14.6	17.0	18.7
31= 36 3	47	17.3	1.1	15.4	17.3	18.9
37= 42	118	17.7	1.1	15.5	17.6	19.4
43= 48 4	113	17.8	1.0	16.1	17.7	19.6
49= 54	150	18.1	1.1	16.1	18.0	19.9
55= 60 5	149	18.6	1.2	16.2	18.6	20.7
61= 66	112	19.1	1.3	16.9	19.0	21.3
67= 72 6	87	19.6	1.5	17.3	19.5	21.9
73= 78	68	19.9	1.3	17.2	19.8	21.9
79= 84 7	72	20.7	1.4	18.3	20.5	22.9
85= 96 8	112	21.3	1.8	18.6	21.0	24.2
97=108 9	106	22.1	1.5	19.8	21.9	24.6
109=120 10	78	22.8	1.4	20.4	22.8	25.1
121=132 11	84	24.5	1.9	21.7	24.4	28.0
133=144 12	42	25.5	1.6	23.5	25.1	28.5
145=156 13	16	26.2	2.0	23.8	25.5	30.9

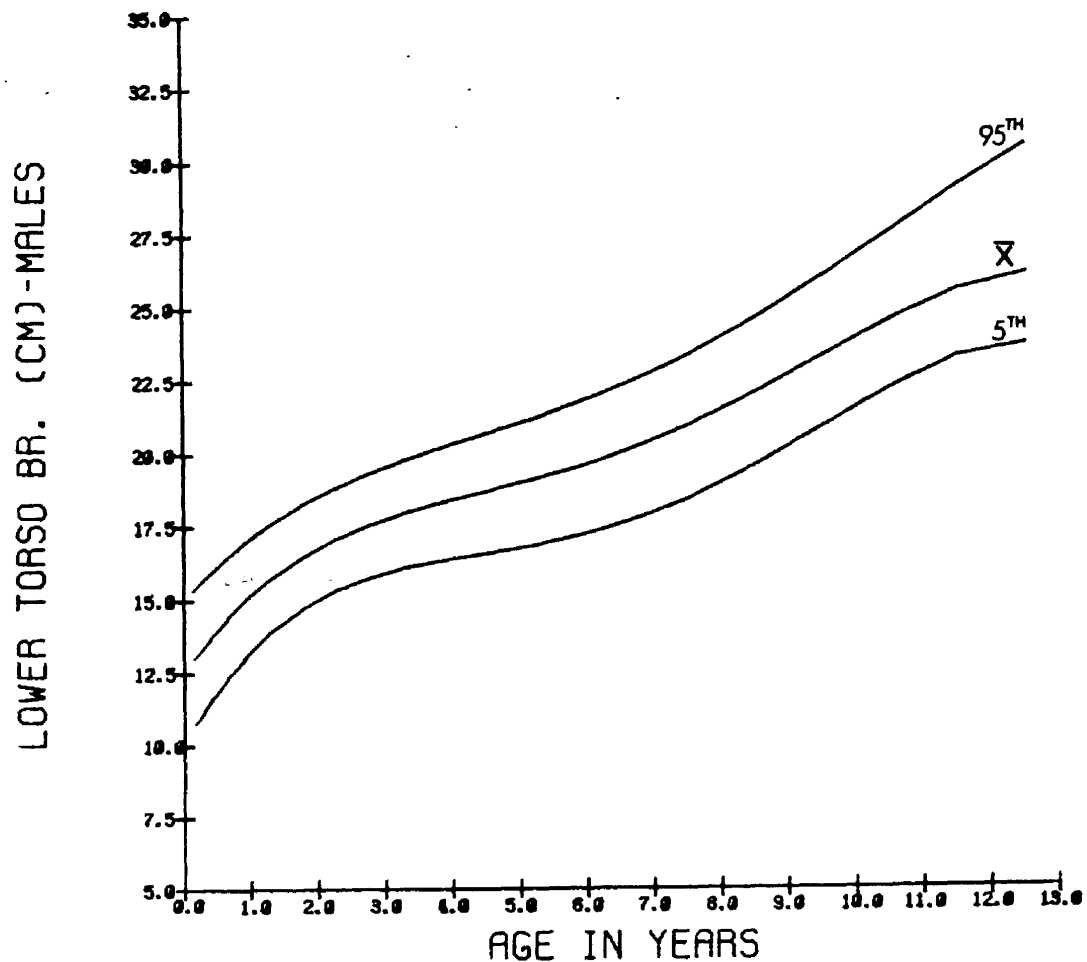

## HEAD LENGTH

Device: Automated anthropometer or sliding caliper. Measurements are recorded automatically by computer.

Description: INFANT: Infant lies on back with head held (supported) free from crib surface. Measure the distance between glabella and the most posterior point on the occiput with an automated sliding caliper. The paddle-blades firmly contact the two body surfaces for measurement. An assistant is required to assure that the infant is in the correct position.

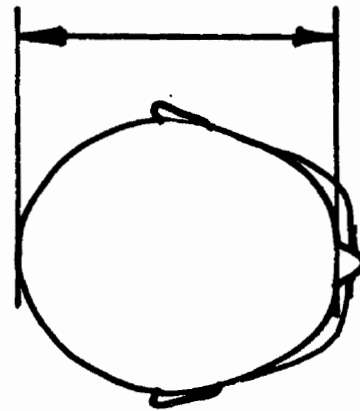
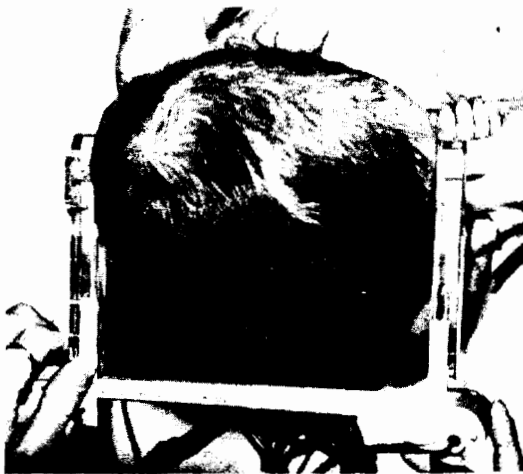

Description: CHILD: Child sits erect, arms hanging at side. Measure the length between glabella and the most posterior point on the occiput with an automated anthropometer. The paddle-blades firmly contact the two body surfaces for measurement.

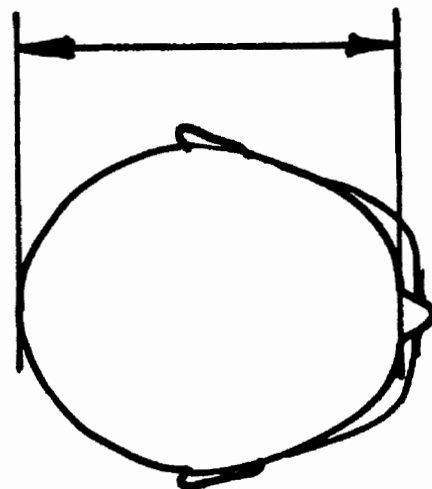



HEAD LENGTH, IN CMS. - COMBINED SEXES

AGE(MO/YRS)	N	MEAN	S.D.	5%	50%	95%
0= 3	139	13.3	0.9	11.7	13.1	14.9
4= 6	97	14.9	0.6	13.8	14.8	16.0
7= 9	54	15.9	0.6	14.8	15.7	16.9
10= 12 1	39	16.1	0.5	14.9	16.1	16.8
13= 18	52	16.7	0.6	15.3	16.7	17.6
19= 24 2	70	17.2	0.7	16.0	17.2	18.4
25= 30	65	17.5	0.6	16.6	17.4	18.6
31= 36 3	104	17.6	0.6	16.5	17.5	18.5
37= 42	272	17.8	0.6	16.6	17.7	18.9
43= 48 4	293	17.9	0.6	16.7	17.8	18.9
49= 54	354	18.0	0.6	16.8	18.0	19.1
55= 60 5	330	18.0	0.7	16.9	17.9	19.2
61= 66	246	18.2	0.6	16.9	18.0	19.3
67= 72 6	174	18.3	0.6	17.3	18.2	19.4
73= 78	175	18.2	0.7	17.0	18.2	19.4
79= 84 7	175	18.2	0.7	17.1	18.1	19.3
85= 96 8	282	18.3	0.7	17.0	18.3	19.5
97=108 9	278	18.5	0.7	17.2	18.5	19.7
109=120 10	263	18.5	0.6	17.3	18.5	19.6
121=132 11	209	18.7	0.7	17.4	18.6	19.8
133=144 12	117	18.7	0.7	17.1	18.6	19.7
145=156 13	51	18.8	0.6	17.3	18.9	19.8

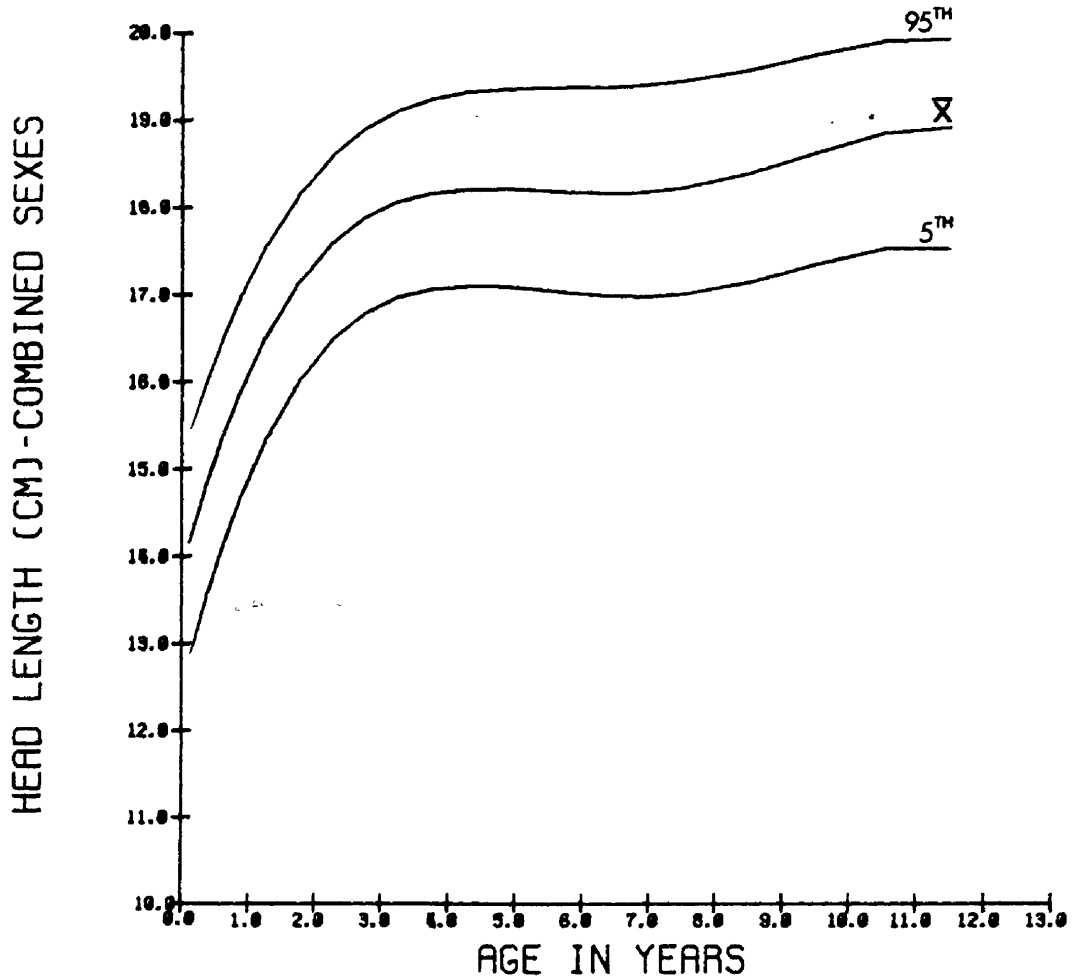

HEAD LENGTH, IN CMS. - FEMALES

AGE (MO/YRS)	N	MEAN	S.D.	5%	50%	95%
0- 3	62	13.2	0.9	11.9	13.1	14.7
4- 6	56	14.7	0.6	13.6	14.8	15.7
7- 9	29	15.6	0.4	14.8	15.6	16.4
10- 12	1	22	0.5	14.8	16.1	16.6
13- 18	22	16.4	0.6	15.4	16.4	17.4
19- 24	2	29	0.6	15.6	16.9	17.6
25- 30	31	17.4	0.5	16.7	17.3	18.3
31- 36	3	55	0.5	16.3	17.2	18.3
37- 42	141	17.6	0.5	16.6	17.5	18.4
43- 48	170	17.6	0.6	16.7	17.6	18.6
49- 54	183	17.7	0.6	16.7	17.7	18.7
55- 60	175	17.8	0.5	16.8	17.7	18.7
61- 66	120	17.8	0.6	16.8	17.7	19.0
67- 72	81	18.1	0.5	17.2	18.0	19.0
73- 78	99	17.9	0.6	16.7	17.8	18.8
79- 84	96	18.0	0.5	17.0	18.0	18.9
85- 96	147	18.1	0.6	16.9	18.1	19.1
97-108	145	18.3	0.6	17.1	18.2	19.1
109-120	155	18.3	0.6	17.2	18.3	19.3
121-132	108	18.4	0.7	17.1	18.4	19.4
133-144	62	18.4	0.6	17.1	18.4	19.2
145-156	30	18.7	0.6	17.3	18.8	19.7

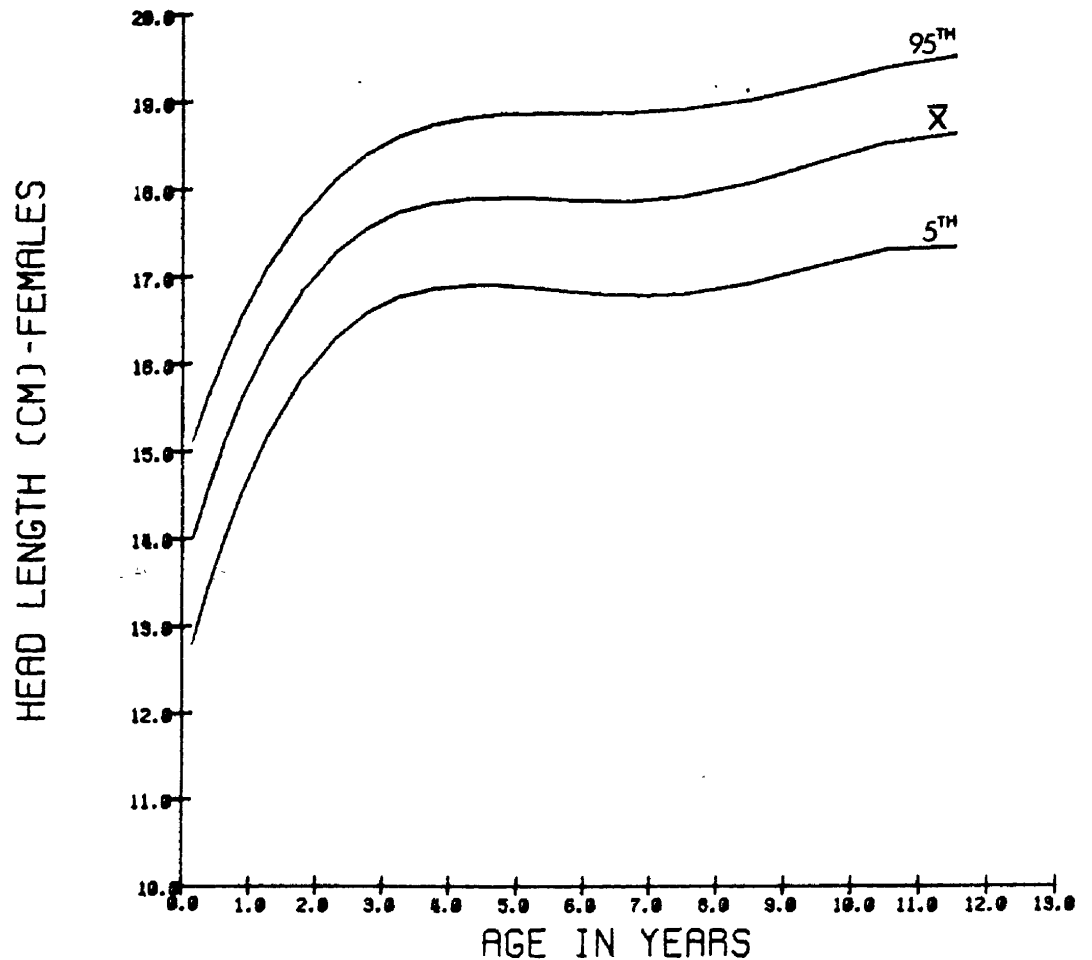

HEAD LENGTH, IN CMS, - MALES

AGE(MO/YRS)	N	MEAN	S.D.	5%	50%	95%	
0= 3	77	13.3	0.9	11.6	13.1	15.0	
4= 6	41	15.1	0.7	14.2	15.0	16.2	
7= 9	25	16.2	0.7	14.4	16.2	17.3	
10= 12	1	17	0.4	15.4	16.1	17.0	
13= 18	30	16.9	0.6	15.4	16.9	17.7	
19= 24	2	41	17.5	0.7	16.4	17.4	18.5
25= 30	34	17.7	0.7	16.7	17.5	18.8	
31= 36	3	49	17.9	0.5	17.0	17.8	18.6
37= 42	131	18.0	0.6	16.9	17.9	19.1	
43= 48	4	123	18.2	0.6	17.0	18.1	19.1
49= 54	171	18.3	0.6	17.2	18.3	19.4	
55= 60	5	155	18.3	0.6	17.0	18.3	19.5
61= 66	126	18.5	0.5	17.6	18.3	19.4	
67= 72	6	93	18.5	0.6	17.4	18.4	19.4
73= 78	76	18.7	0.6	17.6	18.6	19.6	
79= 84	7	79	18.5	0.7	17.1	18.5	19.6
85= 96	8	135	18.6	0.7	17.2	18.6	19.6
97=108	9	133	18.8	0.7	17.3	18.8	19.8
109=120	10	108	18.7	0.6	17.5	18.7	19.6
121=132	11	101	19.0	0.6	17.9	18.9	19.9
133=144	12	55	19.0	0.7	17.6	19.0	20.0
145=156	13	21	18.9	0.6	17.4	18.9	19.9

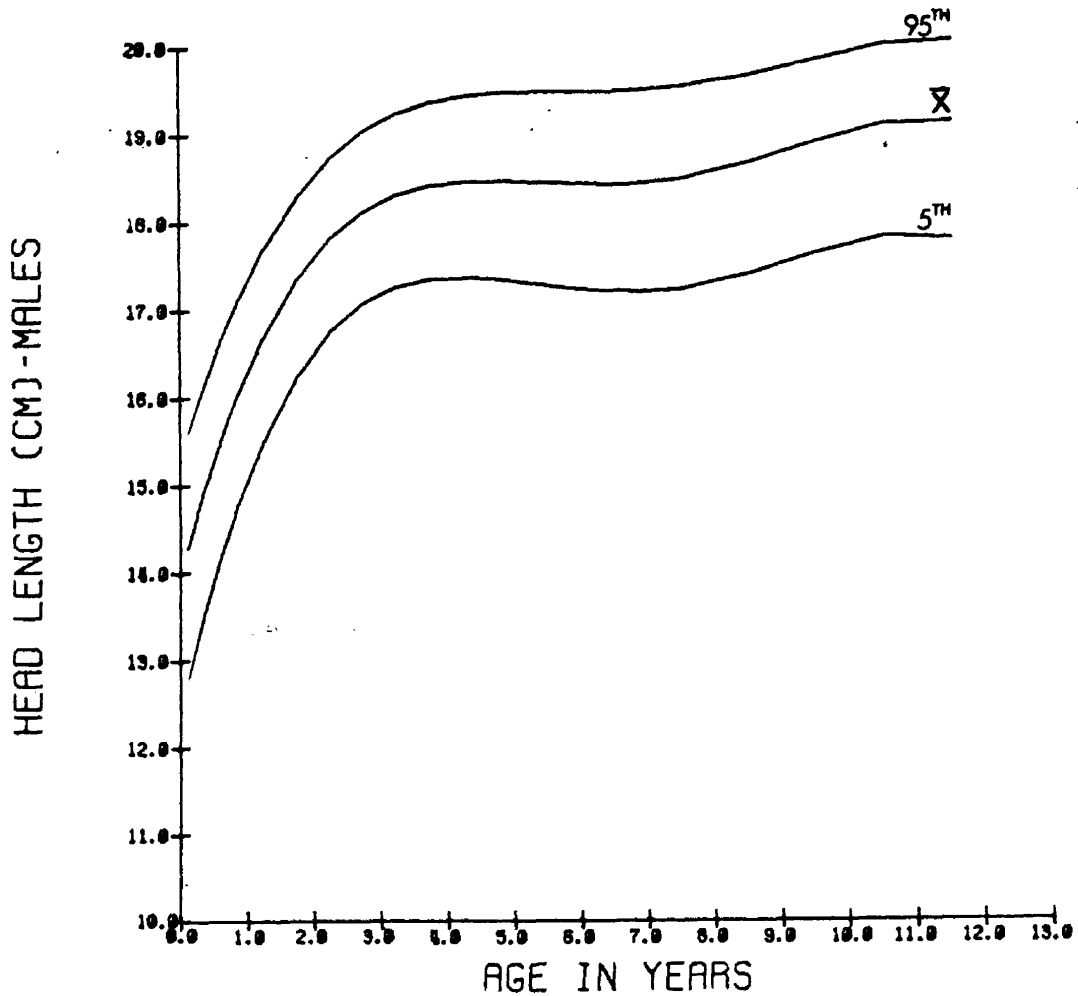

## CHEST DEPTH

Device: Automated anthropometer or sliding caliper equipped with pressure transducer in paddle blade. Measurements are recorded automatically by computer at fixed pressure values.

Description: INFANT: Infant lies on left side. Measure the depth (anterior-posterior distance) at the level of the nipples during normal breathing with an automated sliding caliper. Pressure is momentarily applied with the pressure-transducer paddle-blade on the back. An assistant is required to assure that the infant is in the proper position.

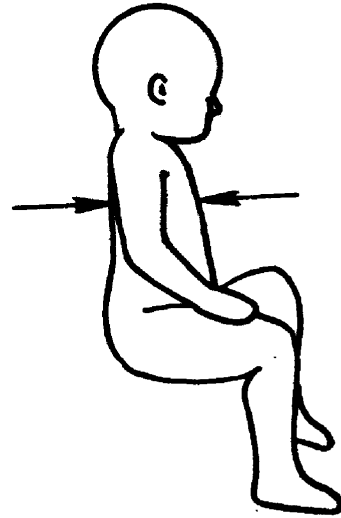
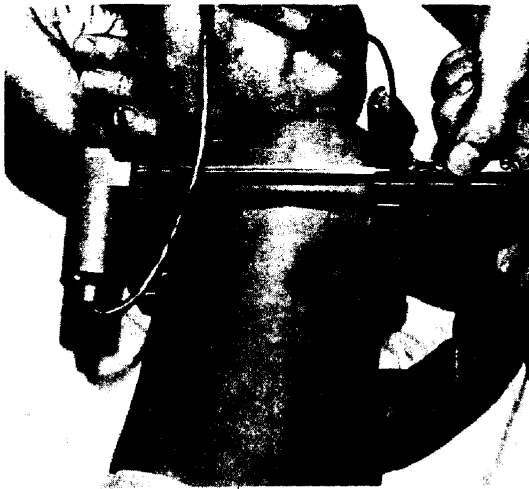

Description: CHILD: Child stands erect, arms hanging at side. Measure the maximum horizontal depth (anterior-posterior distance) of the chest at the level of the nipples during normal breathing with an automated anthropometer. Pressure is applied momentarily with the pressure transducer paddle-blade on the back of the child.

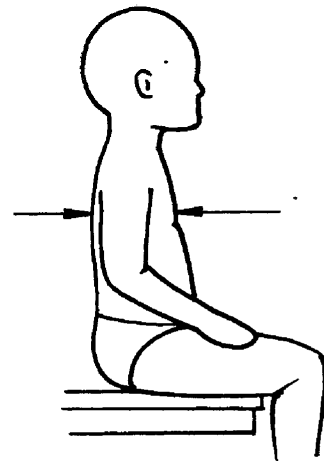
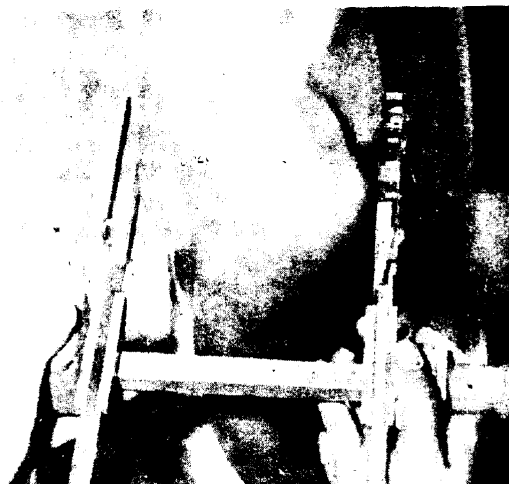

CHEST DEPTH, IN CMS. - COMBINED SEXES

AGE(MO/YRS)	N	MEAN	S.D.	5%	50%	95%	
0- 3	134	9.1	0.9	7.5	9.2	10.7	
4- 6	95	9.9	0.9	8.1	9.9	11.1	
7- 9	46	10.4	0.8	9.0	10.4	11.9	
10- 12	1	38	10.7	0.9	8.9	11.0	11.8
13- 18	48	10.9	0.9	9.4	11.0	12.1	
19- 24	2	64	11.5	1.0	9.8	11.6	12.8
25- 30	62	11.6	0.8	10.3	11.6	12.8	
31- 36	3	101	11.9	1.0	10.3	11.9	13.5
37- 42	263	12.2	0.9	10.6	12.2	13.7	
43- 48	4	289	12.3	0.8	10.8	12.3	13.8
49- 54	352	12.7	0.9	11.0	12.6	14.2	
55- 60	5	328	12.8	1.1	11.0	12.8	14.7
61- 66	238	13.0	0.9	11.3	13.1	14.4	
67- 72	6	174	13.3	1.0	11.6	13.3	15.1
73- 78	176	13.5	0.9	11.8	13.4	15.0	
79- 84	7	170	13.8	1.0	12.1	13.7	15.6
85- 96	8	272	14.0	1.3	11.8	13.8	16.4
97-108	9	273	14.6	1.4	12.6	14.4	17.1
109-120	10	239	14.9	1.5	12.5	14.6	17.5
121-132	11	193	15.9	1.8	13.4	15.7	19.7
133-144	12	98	16.5	1.6	14.1	16.1	19.5
145-156	13	48	17.6	2.0	15.3	17.1	22.1

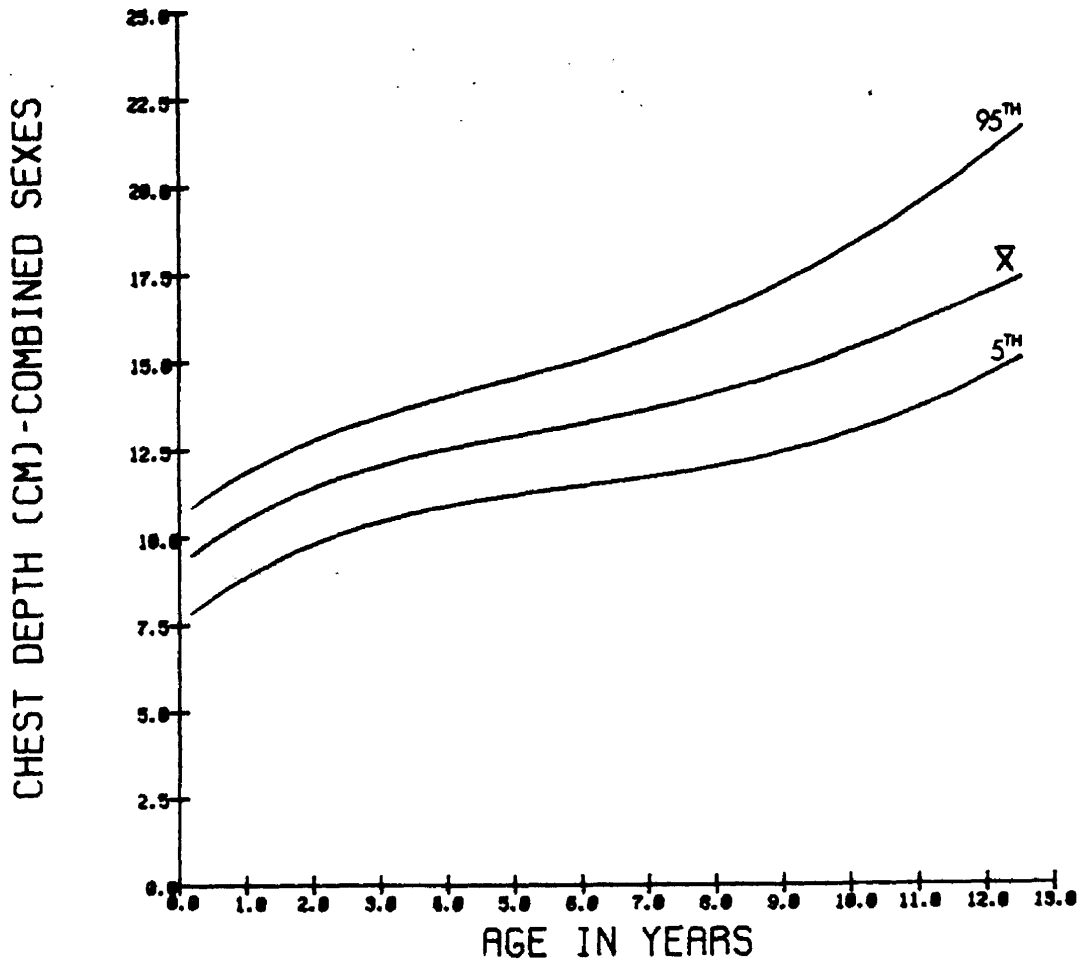

CHEST DEPTH, IN CMS. - FEMALES

AGE(MO/YRS)	N	MEAN	S.D.	5%	50%	95%	
0= 3	62	9.0	0.9	7.5	9.0	10.5	
4= 6	52	9.9	0.9	7.9	10.0	11.1	
7= 9	28	10.5	0.7	9.3	10.4	11.9	
10= 12	1	20	10.4	1.1	7.9	10.2	13.0
13= 18	21	10.9	0.8	9.6	10.9	12.0	
19= 24	2	27	11.3	1.0	8.5	11.5	12.4
25= 30	30	11.6	0.9	9.7	11.6	13.0	
31= 36	3	53	11.8	0.8	10.1	11.9	12.9
37= 42	139	12.1	0.9	10.5	12.1	13.6	
43= 48	4	169	12.2	0.8	10.7	12.2	13.4
49= 54	184	12.5	0.9	10.8	12.5	13.8	
55= 60	5	174	12.7	1.1	10.9	12.6	14.4
61= 66	117	12.8	0.9	10.9	12.7	14.3	
67= 72	6	81	13.2	1.0	11.5	13.2	14.6
73= 78	99	13.4	0.9	11.7	13.2	15.0	
79= 84	7	92	13.5	1.0	11.8	13.4	15.2
85= 96	8	140	13.7	1.4	11.7	13.6	16.4
97=108	9	140	14.4	1.4	12.4	14.1	17.4
109=120	10	136	14.7	1.5	12.2	14.5	17.5
121=132	11	93	15.7	2.0	13.2	15.3	19.7
133=144	12	47	16.2	1.7	13.3	16.1	19.6
145=156	13	27	17.9	2.2	14.1	17.6	22.3

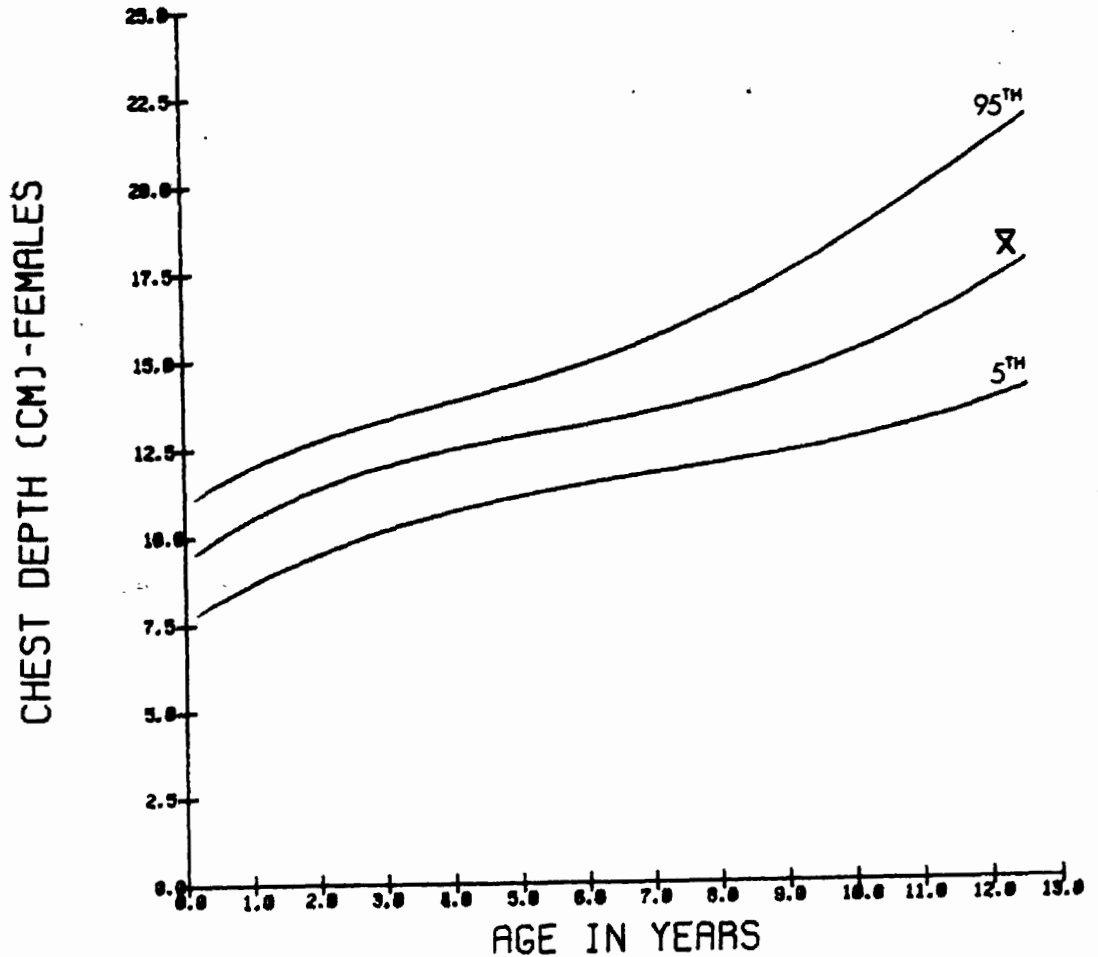

## BUTTOCK DEPTH

Device: Automated anthropometer or sliding caliper with pressure transducer in paddle blade. Measurements are recorded automatically by computer at fixed pressure values.

Description: INFANT: Infant lies on left side with legs fully extended in the Grenouille position. Measure the depth from the maximum protrusion of the buttock to the surface of the upper leg at the level previously established for buttock breadth (No. 19) with an automated anthropometer. Pressure is momentarily applied with the pressure-transducer paddle blade on the buttock. An assistant is required to assure that the infant is in the correct position.

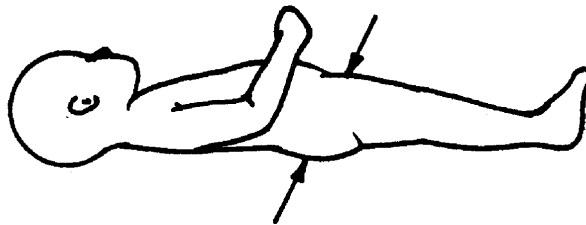
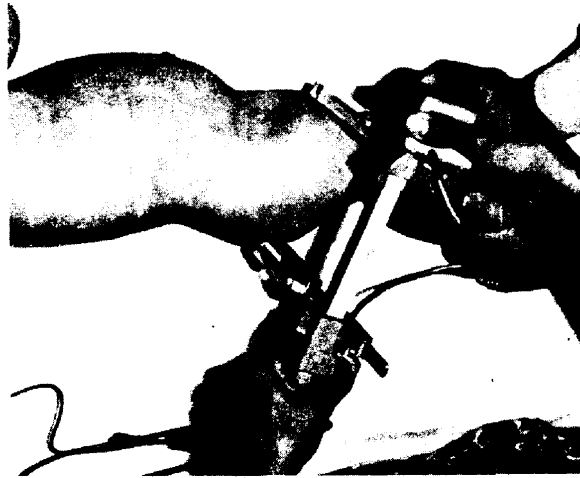

BUTTOCKS DEPTH, IN CMS. - COMBINED SEXES

AGE (MO/YRS)	N	MEAN	S. D.	5%	50%	95%	
0- 2	113	7.7	1.3	5.6	7.5	9.9	
3- 4	54	9.3	1.0	7.5	9.3	11.0	
5- 6	55	9.9	1.3	7.6	9.8	11.9	
7- 8	23	10.1	1.1	7.9	10.0	11.6	
9- 10	26	10.4	1.1	8.2	10.1	11.7	
11- 12	1	15	10.4	1.6	8.4	9.5	13.5
13- 14	10	11.5	1.1	10.0	11.3	13.5	
15- 16	5	12.2	2.6	9.5	11.1	15.2	
17- 18	13	10.6	1.9	8.7	10.4	14.8	
19- 20	8	11.2	1.1	9.2	11.0	12.3	
21- 22	11	12.1	2.6	8.3	12.1	16.3	
23- 24	2	10	11.8	1.8	8.9	12.5	

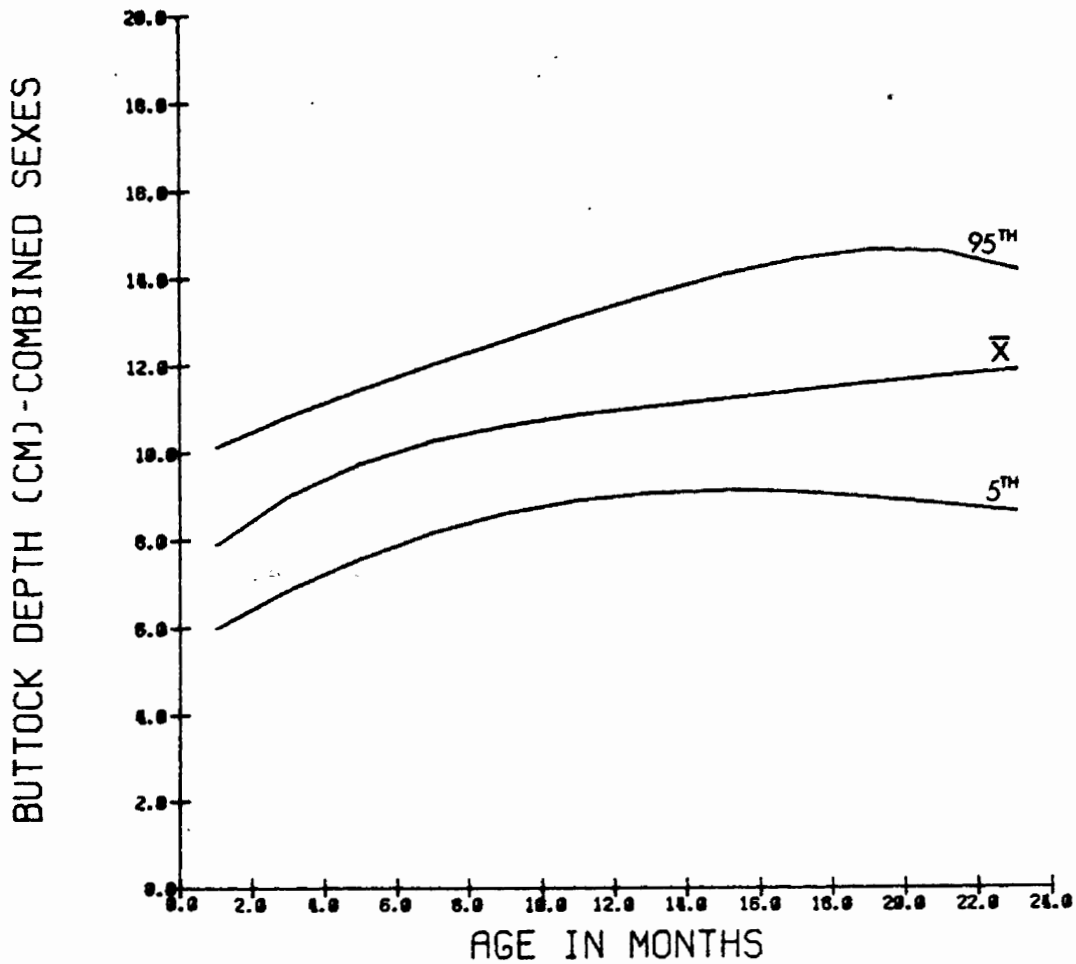



BUTTOCKS DEPTH, IN CMS. -- FEMALES

AGE(MO/YRS)	N	MEAN	S.D.	5%	50%	95%
0- 2	50	7.8	1.4	5.6	7.6	9.9
3- 4	28	9.3	1.0	7.6	9.3	10.9
5- 6	30	10.1	1.3	7.6	10.2	11.7
7- 8	14	10.1	1.1	8.2	10.0	11.7
9- 10	14	10.2	1.0	8.1	10.1	11.8
11- 12	1	10.7	1.7	9.4	9.5	13.5
13- 14	7	11.0	0.6	10.0	11.2	11.8
15- 16	6	0.6	0.0	0.0	0.0	0.0
17- 18	4	12.3	2.7	8.8	11.5	14.8
19- 20	5	10.6	1.0	9.2	10.4	12.0
21- 22	4	11.5	3.5	8.3	8.6	14.7
23- 24	2	12.0	1.9	9.3	12.5	13.7

BUTTOCK DEPTH (CM)-FEMALES

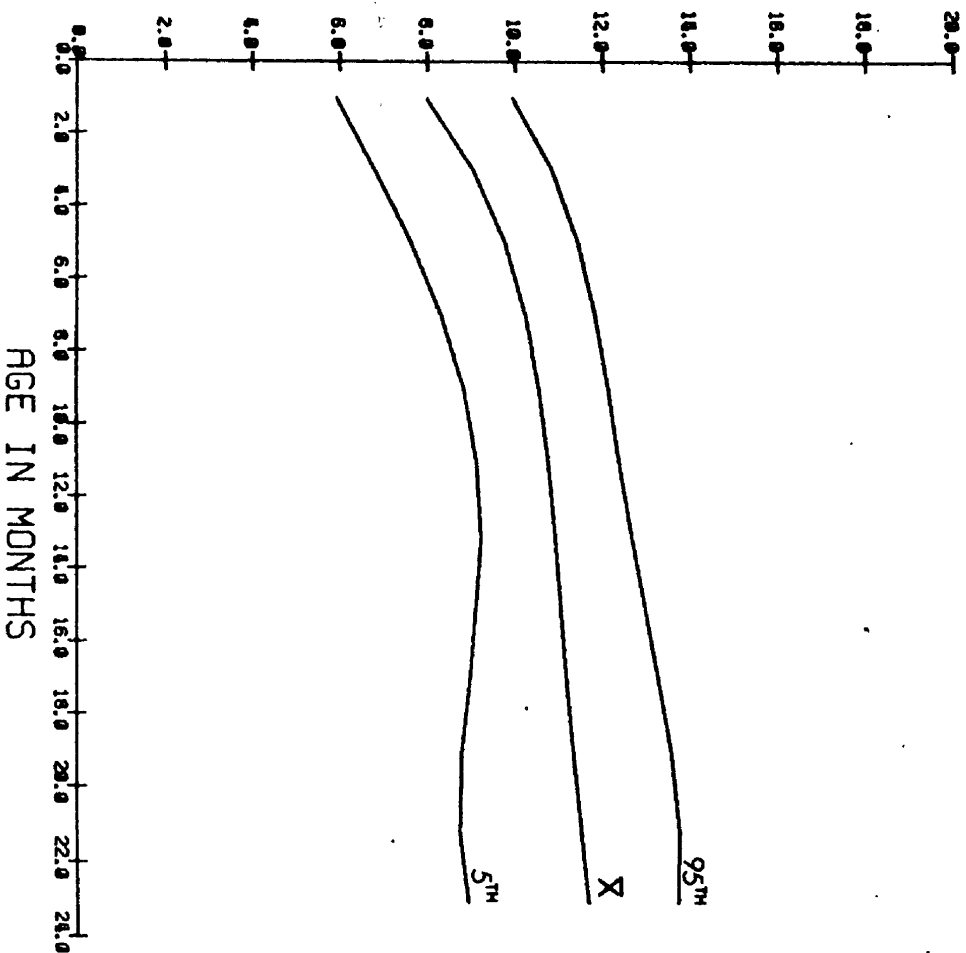

BUTTOCKS DEPTH, IN CMS. - MALES

AGE (MO/YRS)	N	MEAN	S. D.	5%	50%	95%	
0- 2	63	7.6	1.2	5.6	7.3	9.3	
3- 4	26	9.4	1.1	7.1	9.3	10.9	
5- 6	25	9.6	1.4	7.6	9.2	12.3	
7- 8	9	10.0	1.1	7.9	9.9	11.9	
9- 10	12	10.5	1.3	9.0	10.1	14.1	
11- 12	1	8	10.1	1.5	8.4	9.5	13.3
13- 14	4	12.1	1.6	10.0	11.7	13.5	
15- 16	4	12.9	2.4	9.6	12.7	15.2	
17- 18	9	9.9	0.9	8.7	9.6	11.3	
19- 20	3	12.3	0.0	12.3	6.1	12.3	
21- 22	7	12.5	2.3	9.1	12.1	16.3	
23- 24	2	6	11.7	1.9	8.9	11.2	13.8

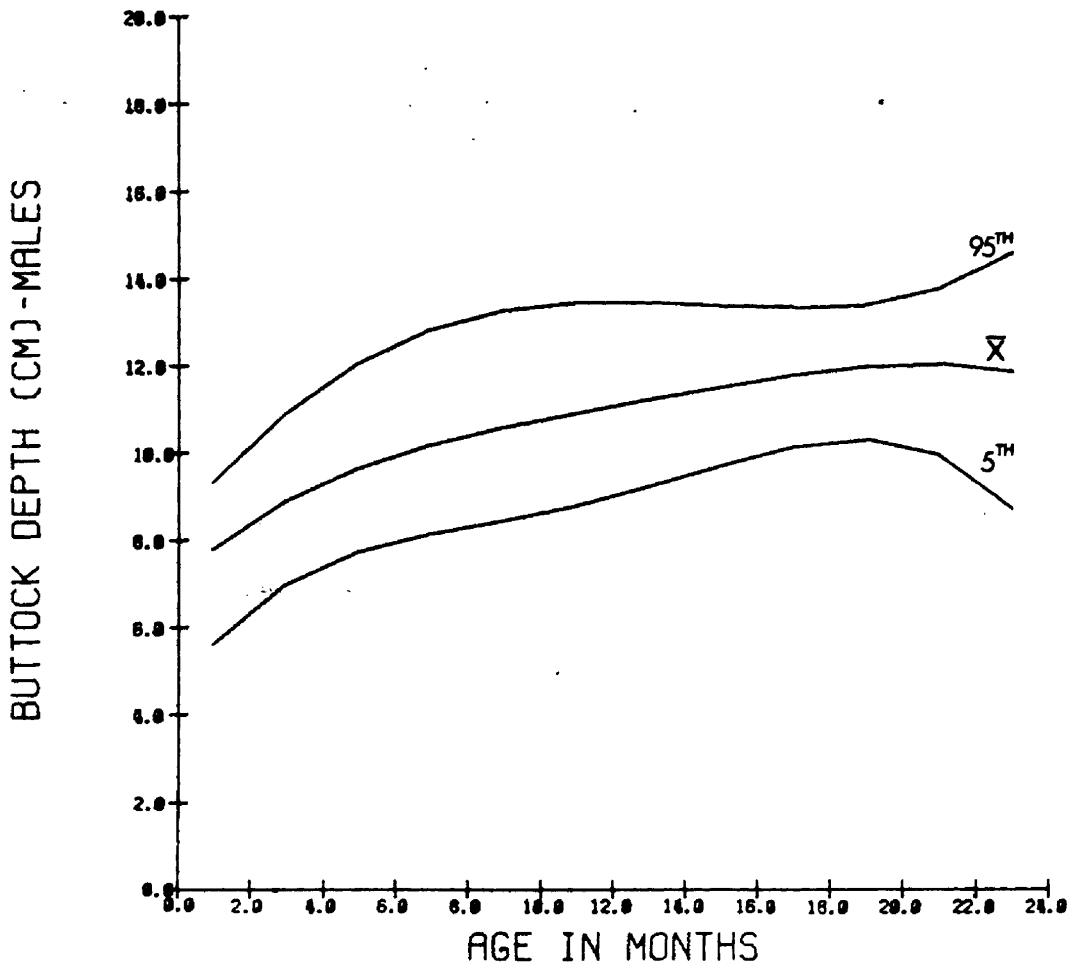

## HIP DEPTH

Device: Automated anthropometer or sliding caliper with pressure transducer in paddle blade. Measurements are recorded automatically by computer at fixed values.

Description: INFANT: Infant lies on left side with legs fully extended. Measure the depth (anterior-posterior distance) just below the iliac crests at the same level as the hip breadth measurement with an automated anthropometer. Pressure is momentarily applied with the pressure-transducer paddle blade on the buttock. An assistant is required to assure that the infant is in the correct position.

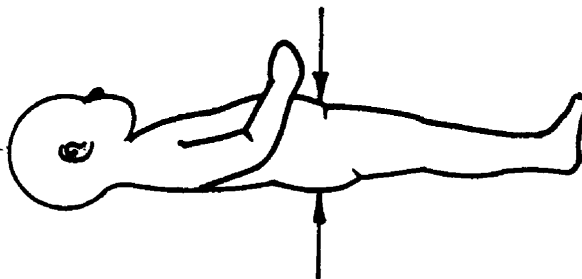

HIP DEPTH, IN CMS. - COMBINED SEXES

AGE (MO/YRS)	N	MEAN	S. D.	5%	50%	95%
1- 2	113	7.3	1.1	5.3	7.3	9.2
3- 4	54	8.7	1.1	6.9	8.5	10.7
5- 6	55	9.2	1.2	7.0	9.2	11.4
7- 8	22	9.3	1.2	7.6	8.7	11.0
9- 10	27	9.4	1.3	6.6	9.4	11.1
11- 12	17	8.9	1.1	7.5	8.6	12.1
13- 14	12	9.8	1.1	7.4	9.9	10.9
15- 16	6	10.2	1.6	7.6	10.0	11.9
17- 18	14	9.6	1.2	7.4	9.6	11.5
19- 20	9	9.7	1.4	8.2	9.2	12.3
21- 22	11	9.8	1.5	7.1	10.3	11.5
23- 24	10	10.2	0.9	9.2	9.8	12.4

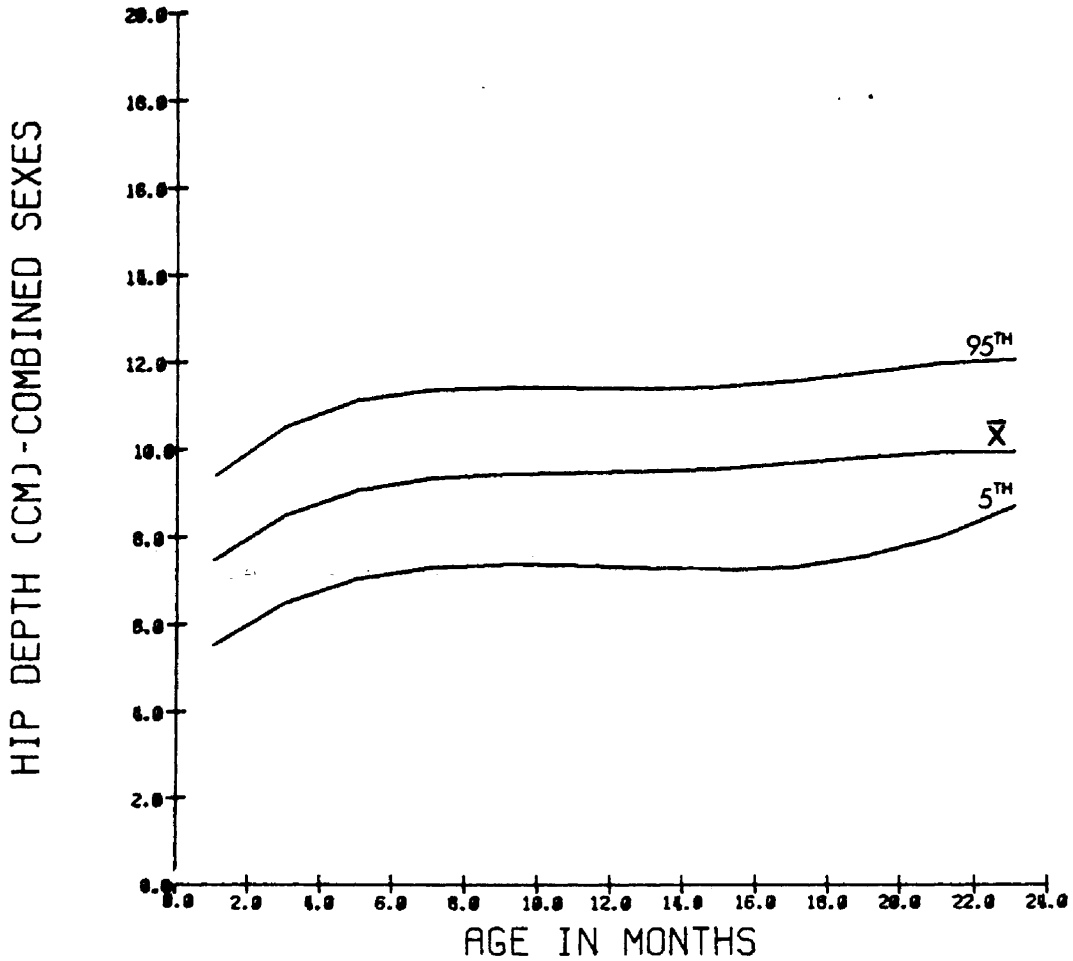

HIP DEPTH, IN CMS. - FEMALES

AGE(MO/YRS)	N	MEAN	S.D.	5%	50%	95%
0- 2	51	7.3	1.3	5.1	7.2	9.4
3- 4	28	8.6	0.9	7.1	8.4	10.3
5- 6	30	9.5	1.2	7.2	9.6	11.6
7- 8	13	9.5	1.3	7.6	9.2	11.3
9- 10	14	9.0	1.2	6.3	9.0	11.0
11- 12 1	9	8.8	1.4	7.5	8.5	12.1
13- 14	6	9.7	1.1	7.5	9.9	10.8
15- 16	2	10.5	1.9	9.1	9.1	11.9
17- 18	4	10.6	0.7	9.6	10.5	11.5
19- 20	5	9.2	1.4	8.2	8.4	11.7
21- 22	4	8.9	1.9	7.1	7.5	10.7
23- 24 2	4	9.7	0.7	9.2	9.4	10.9

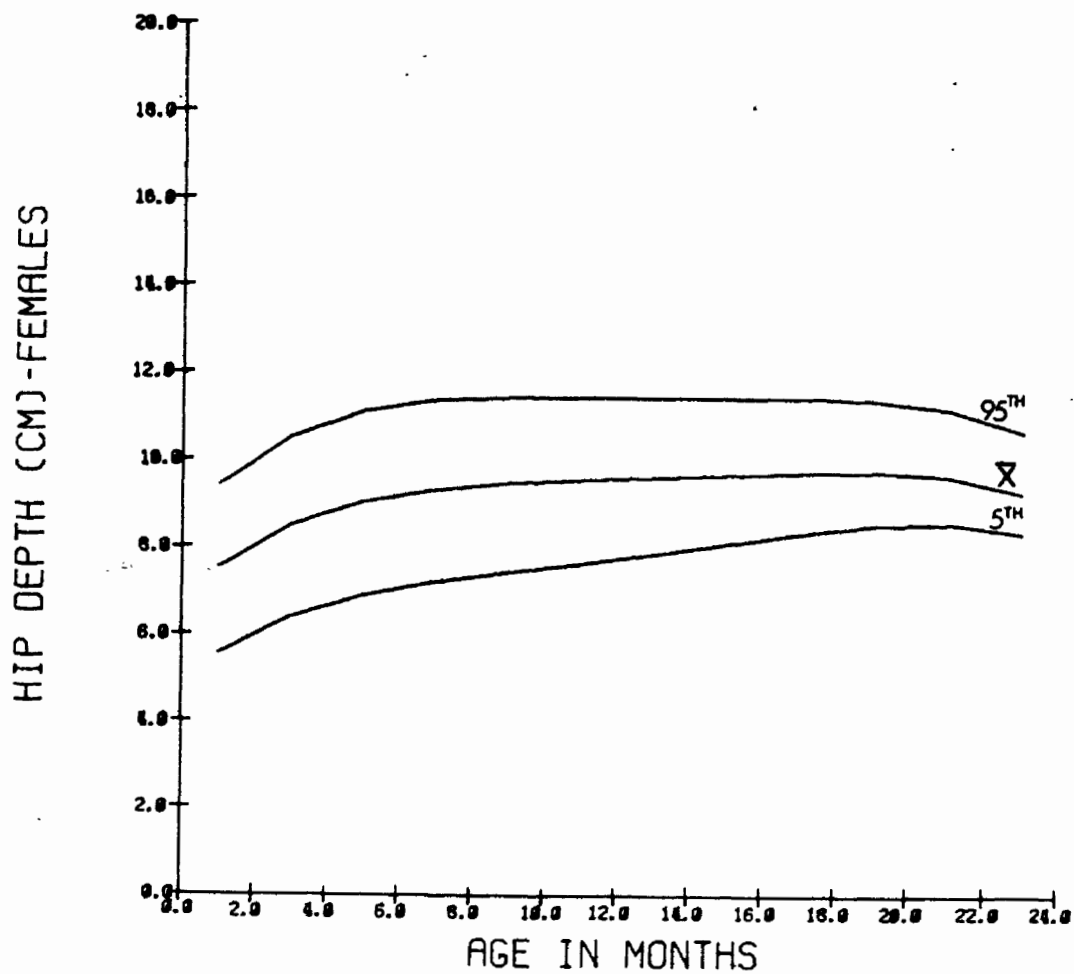

HIP DEPTH, IN CMS. - MALES

AGE(MO/YRS)	N	MEAN	S.D.	5%	50%	95%
0- 2	62	7.3	1.0	5.3	7.3	8.9
3- 4	26	8.8	1.3	6.4	8.6	11.5
5- 6	25	8.9	1.0	4.4	8.8	10.4
7- 8	9	9.1	1.2	7.7	8.3	11.1
9- 10	13	9.8	1.3	7.9	9.5	13.3
11- 12 1	8	9.1	0.9	7.9	8.8	10.7
13- 14	6	9.8	1.3	7.4	10.0	10.9
15- 16	4	10.0	1.7	7.6	10.0	11.7
17- 18	10	9.3	1.2	7.4	8.9	11.4
19- 20	4	10.4	1.3	9.2	9.9	12.3
21- 22	7	10.3	1.1	8.3	10.1	11.5
23- 24 2	6	10.5	1.0	9.5	10.2	12.4

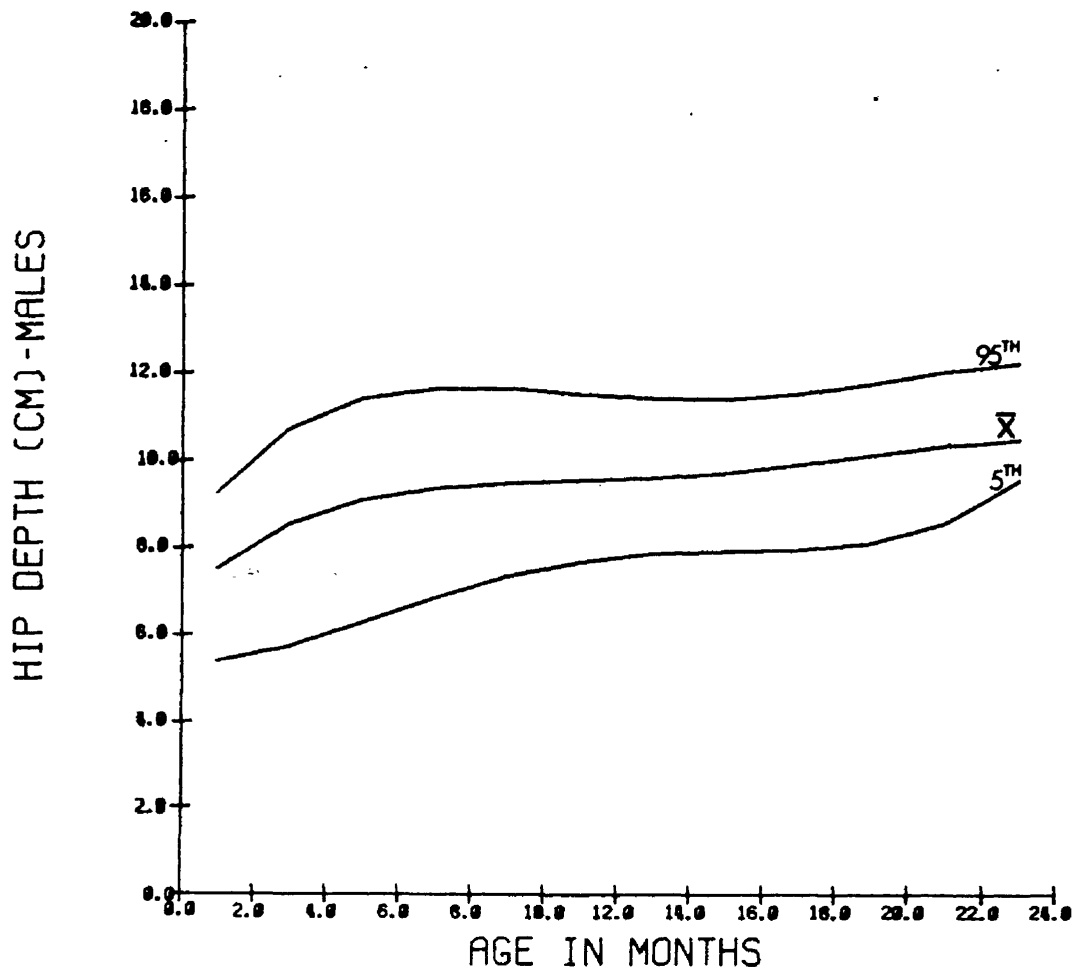

## HEAD CIRCUMFERENCE

Device: Automated tape device. Measurements are recorded automatically at constant tension by computer.

Description: INFANT: Infant lies or sits with head supported away from crib surface. Measure the circumference with an automated tape device that applies constant tension at the level of a plane passing through glabella, at the most posterior protrusion on the occiput, and perpendicular to the mid-sagittal plane. An assistant is required to assure that the infant is in the correct position.

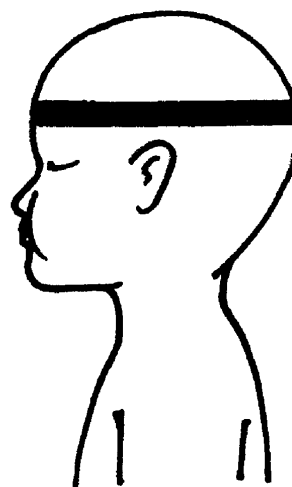

Description: CHILD: Child sits erect, arms hanging at side. Measure the circumference with an automated tape device that applies constant tension at the level of a plane passing through glabella, the most posterior protrusion on the occiput, and perpendicular to the mid-sagittal plane.

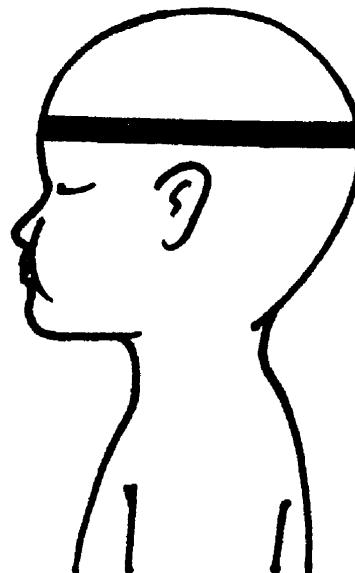
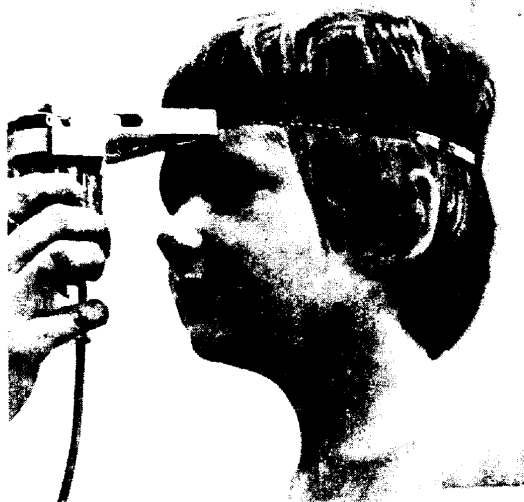

HEAD CIRCUMFERENCE, IN CMS. - COMBINED SEXES

AGE (MO/YRS)	N	MEAN	S.D.	5%	50%	95%
0= 3	129	37.8	2.3	34.2	37.8	41.5
4= 6	90	42.5	1.7	39.1	42.5	45.5
7= 9	44	45.4	1.6	43.0	44.8	48.5
10= 12	1	38	1.2	43.6	45.6	47.8
13= 18	42	47.4	1.6	44.9	47.2	49.9
19= 24	2	64	1.6	46.7	48.4	51.8
25= 30	64	49.3	1.5	47.8	49.0	52.2
31= 36	3	101	1.3	47.3	49.7	52.1
37= 42	266	50.1	1.4	47.8	50.1	52.4
43= 48	4	289	1.5	47.7	50.4	53.1
49= 54	351	50.9	1.5	48.9	50.9	53.3
55= 60	5	324	1.5	48.6	51.0	53.4
61= 66	240	51.4	1.5	49.8	51.3	54.1
67= 72	6	170	1.6	48.9	51.5	53.9
73= 78	167	51.6	1.5	49.0	51.5	53.9
79= 84	7	163	1.5	49.2	51.7	54.5
85= 96	8	278	1.5	49.5	51.9	54.6
97=108	9	270	1.5	50.1	52.6	55.2
109=120	10	257	1.6	50.1	52.7	55.6
121=132	11	202	1.5	51.0	53.4	56.0
133=144	12	116	1.5	50.9	53.7	56.5
145=156	13	53	1.5	51.3	54.3	56.6

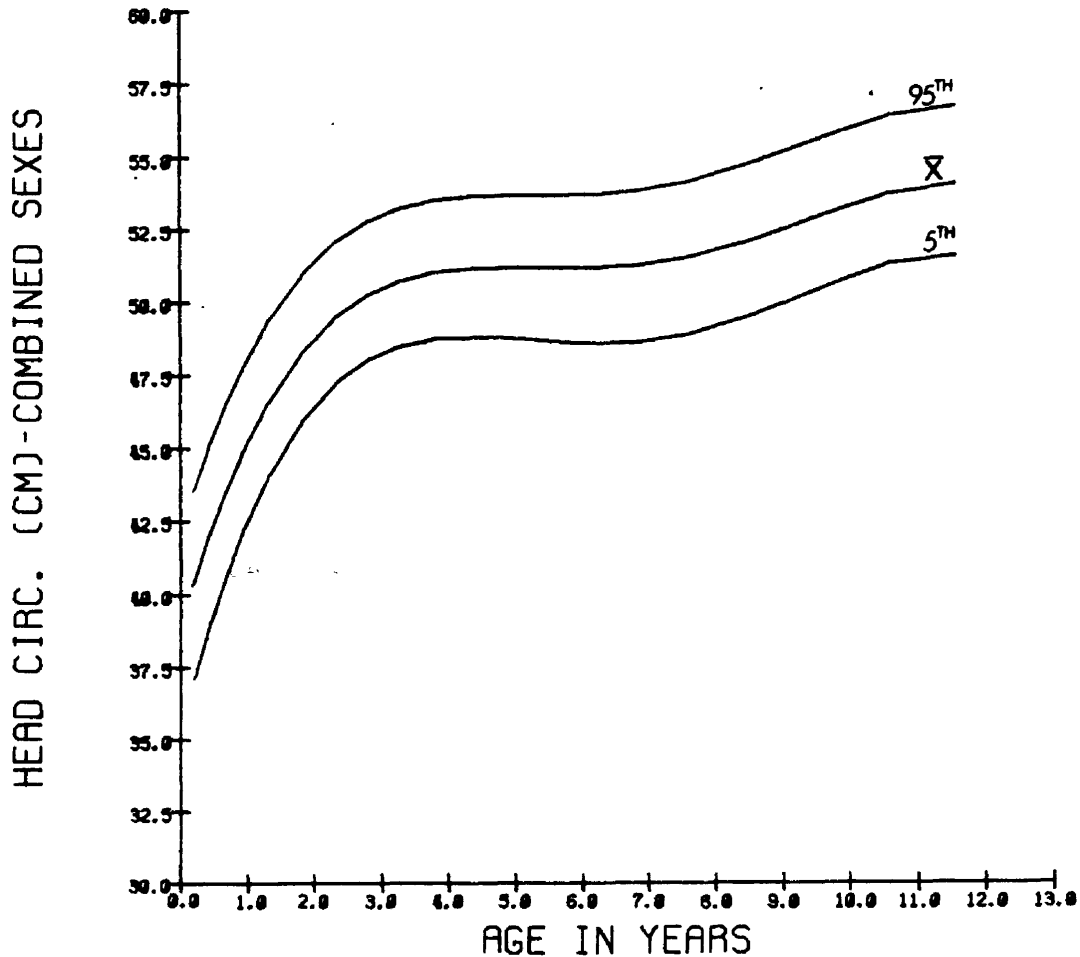



HEAD CIRCUMFERENCE, IN CMS. - FEMALES

AGE(MO/YRS)	N	MEAN	S.D.	5%	50%	95%
0= 3	59	37.6	2.0	34.2	37.4	40.6
4= 6	53	42.0	1.7	38.9	42.1	44.6
7= 9	24	44.6	1.1	42.9	44.5	46.1
10= 12 1	22	45.4	1.1	43.3	45.4	47.0
13= 18	19	46.3	1.2	43.7	46.1	49.4
19= 24 2	27	48.0	1.3	46.1	47.8	50.1
25= 30	31	48.9	1.5	46.5	48.8	51.8
31= 36 3	54	48.9	1.1	46.9	48.8	50.7
37= 42	136	49.6	1.2	47.3	49.6	51.7
43= 48 4	167	50.9	1.5	47.6	49.9	52.7
49= 54	181	50.2	1.4	47.7	50.3	52.4
55= 60 5	171	50.5	1.3	48.3	50.4	52.4
61= 66	115	50.7	1.3	48.4	50.5	52.7
67= 72 6	80	51.0	1.5	48.4	50.8	53.4
73= 78	92	51.0	1.4	48.5	50.9	53.3
79= 84 7	90	51.2	1.2	48.9	51.2	53.1
85= 96 8	146	51.5	1.3	49.1	51.5	54.0
97=108 9	142	52.2	1.3	49.8	52.0	54.0
109=120 10	151	52.3	1.4	49.9	52.3	54.7
121=132 11	105	52.8	1.3	50.6	52.8	55.0
133=144 12	63	53.2	1.4	50.7	53.3	55.2
145=156 13	32	54.1	1.5	51.3	54.2	56.5

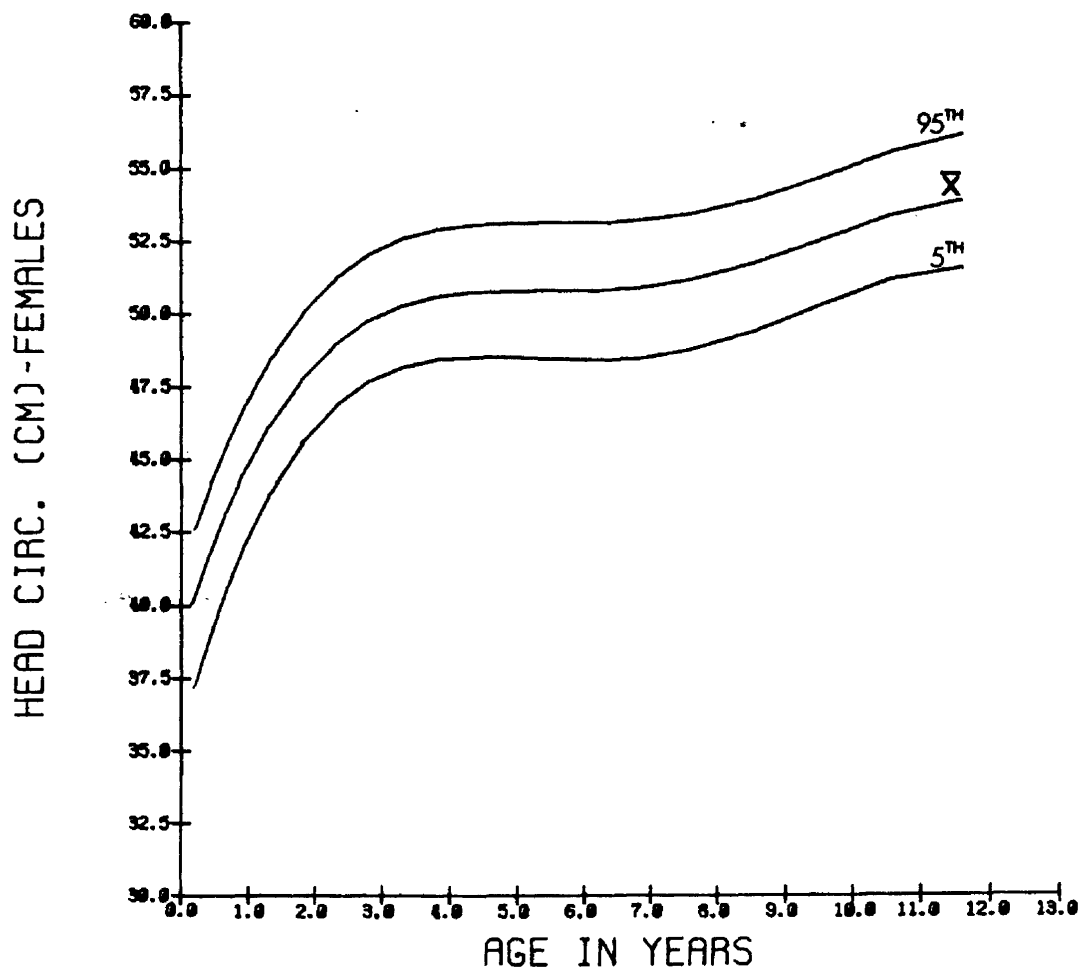

HEAD CIRCUMFERENCE, IN CMS. • MALES

AGE(MO/YRS)	N	MEAN	S.D.	5X	50X	95X
0.0 3	70	38.1	2.4	33.6	38.1	42.1
4.0 6	37	43.2	1.6	40.5	43.0	45.8
7.0 9	20	46.2	1.0	43.6	46.4	49.5
10.0 12	16	46.0	1.3	44.1	46.0	49.0
13.0 18	23	48.3	1.3	46.3	47.9	50.8
19.0 24	37	49.4	1.6	47.1	48.9	51.9
25.0 30	33	49.7	1.3	48.4	49.2	52.3
31.0 36	47	50.4	1.1	48.4	50.2	52.4
37.0 42	130	50.7	1.3	48.5	50.5	53.0
43.0 48	122	51.1	1.3	48.9	50.9	53.3
49.0 54	170	51.5	1.4	49.1	51.5	53.8
55.0 60	153	51.8	1.4	49.2	51.5	54.1
61.0 66	125	52.0	1.3	49.8	52.0	54.3
67.0 72	90	52.1	1.4	49.5	52.2	54.3
73.0 78	75	52.4	1.2	50.7	52.3	54.8
79.0 84	73	52.6	1.5	49.5	52.6	54.9
85.0 96	132	52.7	1.5	50.8	52.6	55.0
97.0 108	128	53.2	1.5	50.3	53.1	55.5
109.0 120	106	53.5	1.5	50.8	53.3	55.8
121.0 132	97	54.2	1.3	52.1	54.0	56.4
133.0 144	53	54.2	1.5	51.1	54.1	57.0
145.0 156	21	54.1	1.4	51.1	54.1	56.4

51.4

HEAD CIRC. (CM)-MALES

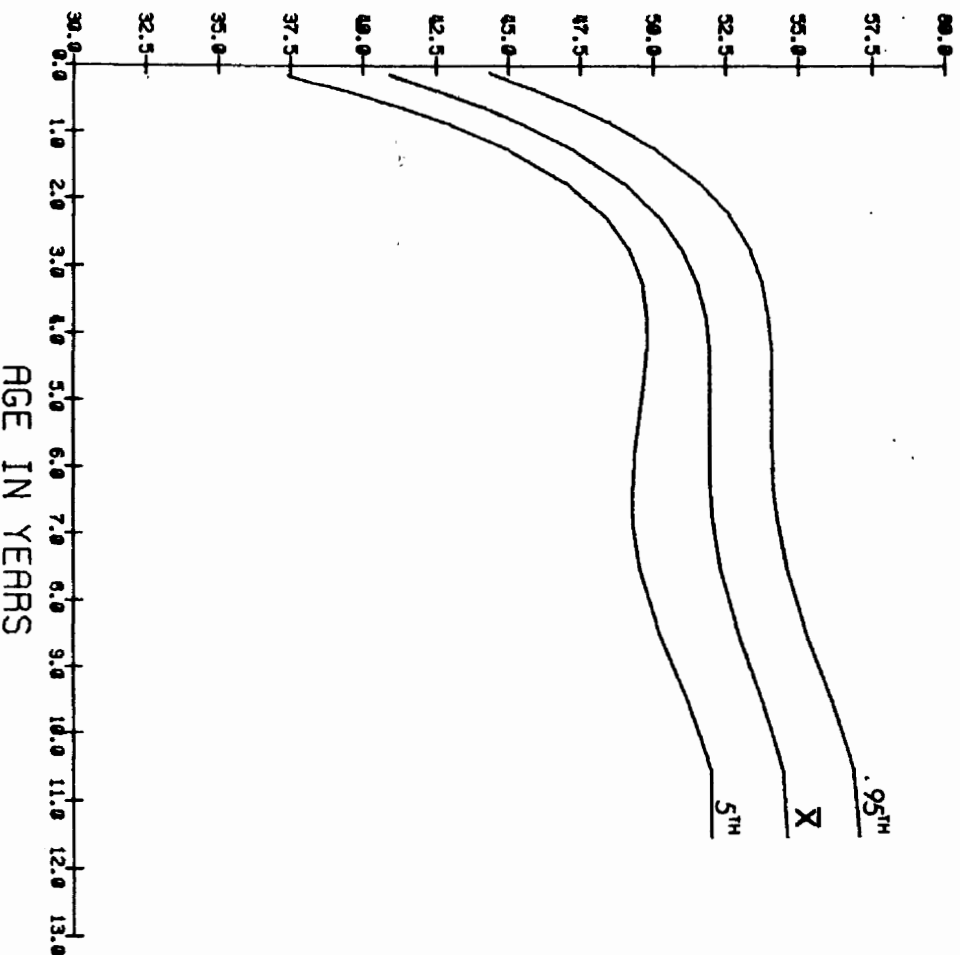

## NECK CIRCUMFERENCE

Device: Automated tape device. Measurements are recorded automatically at constant tension by computer.

Description: CHILD: Child sits erect with head in the Frankfort Plane, arms hanging at side. Measure the horizontal circumference at the base of the neck with an automated tape device that applies constant tension.

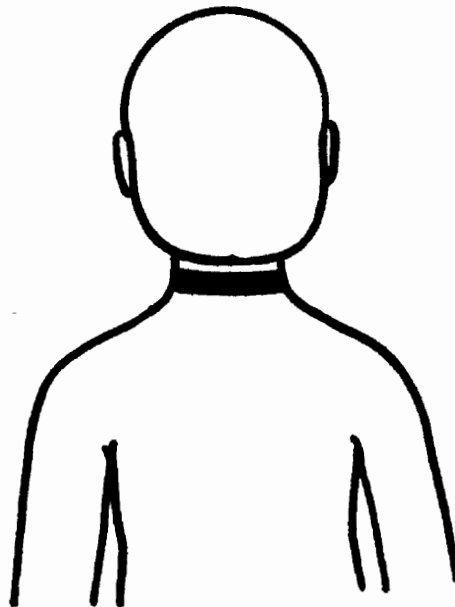
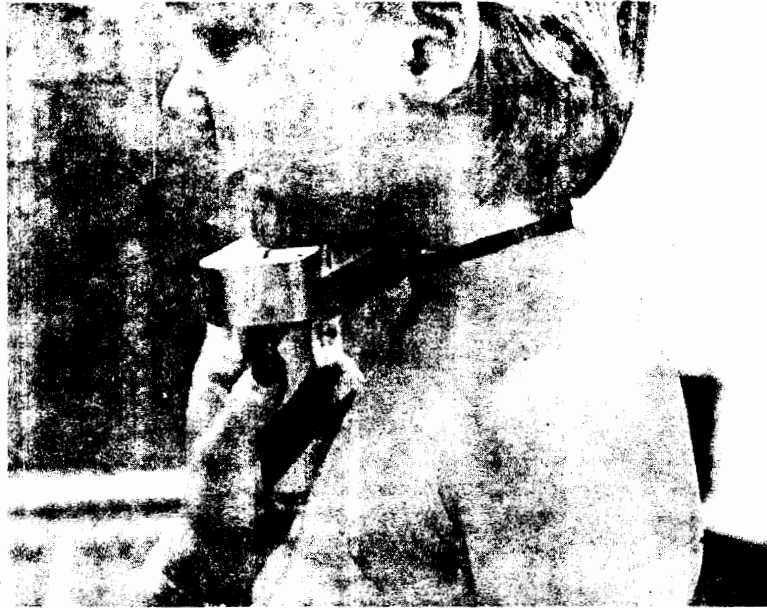

NECK CIRCUMFERENCE, IN CMS. - COMBINED SEXES

AGE(MO/YRS)	N	MEAN	S.D.	5%	50%	95%	
25= 30	51	24.1	1.2	21.7	24.0	25.8	
31= 36	3	98	24.5	1.3	22.2	24.7	26.4
37= 42	261	24.9	1.4	22.3	24.8	27.1	
43= 48	4	288	25.1	1.3	22.9	25.0	27.2
49= 54	355	25.4	1.3	23.2	25.3	27.8	
55= 60	5	323	25.8	1.5	23.2	25.7	28.2
61= 66	239	26.2	1.5	23.6	26.2	28.8	
67= 72	6	168	26.5	1.4	24.3	26.4	28.6
73= 78	166	26.6	1.5	24.2	26.5	28.9	
79= 84	7	161	27.3	1.6	24.5	27.1	30.1
85= 96	8	278	27.5	1.6	24.7	27.4	30.2
97=108	9	270	28.4	1.6	25.9	28.2	30.9
109=120	10	251	28.7	1.7	25.7	28.5	31.5
121=132	11	200	29.8	1.8	26.4	29.9	32.8
133=144	12	112	30.6	1.7	27.6	30.4	33.5
145=156	13	53	31.5	1.8	28.6	31.3	34.3

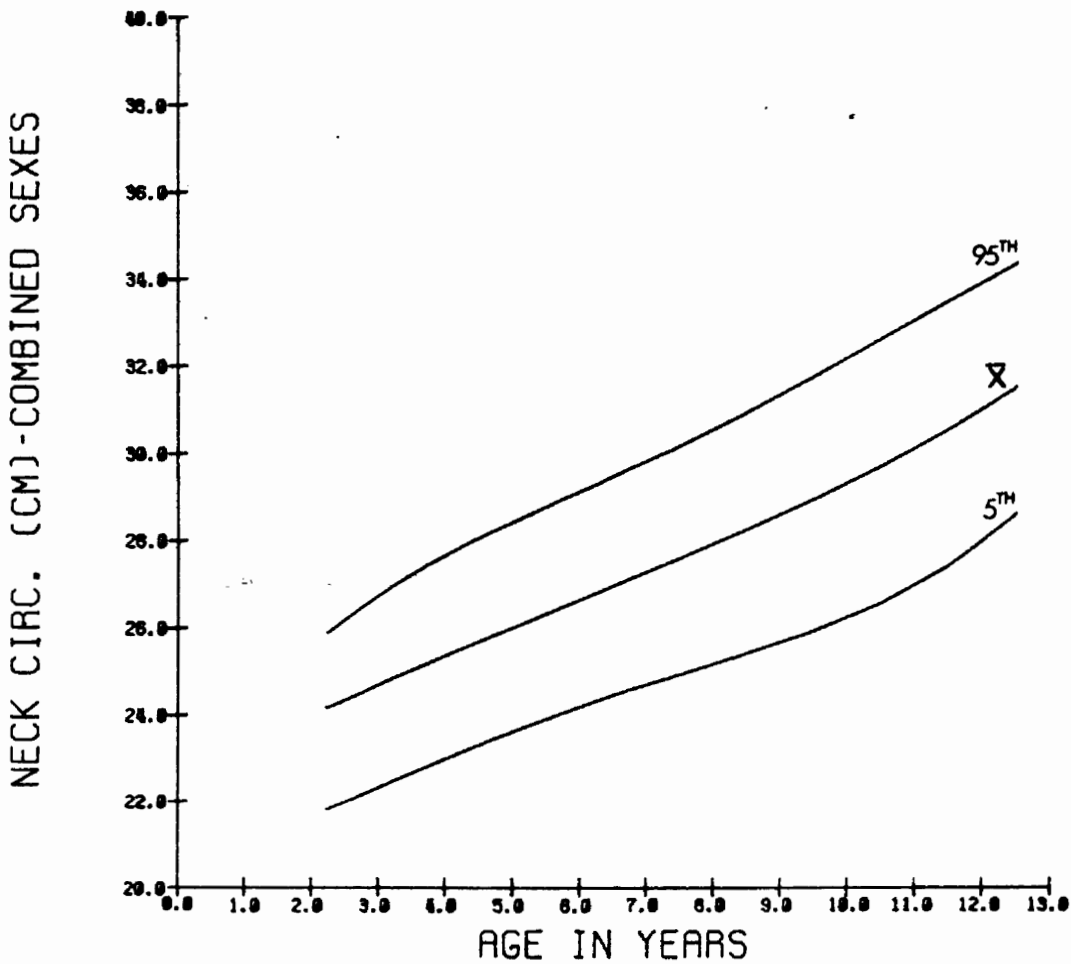

NECK CIRCUMFERENCE, IN CM8. = FEMALES

AGE (MO/YR8)	N	MEAN	S.D.	5%	50%	95%
25= 30	24	23.9	1.5	21.4	23.7	26.6
31= 36	3	24.2	1.3	21.7	24.0	26.1
37= 42	133	24.5	1.4	22.0	24.5	26.8
43= 48	4	166	24.9	1.3	22.8	27.2
49= 54	184	25.1	1.2	22.8	24.9	27.3
55= 60	5	172	25.4	1.5	23.1	27.7
61= 66	114	25.6	1.5	23.0	25.3	28.5
67= 72	6	78	26.0	1.5	23.7	28.6
73= 78	92	26.3	1.5	24.0	26.1	28.7
79= 84	7	88	26.7	1.4	24.0	29.2
85= 96	8	145	26.9	1.5	24.4	29.3
97=108	9	142	27.9	1.5	25.2	30.2
109=120	10	145	28.2	1.6	25.6	31.4
121=132	11	101	29.1	1.8	25.8	31.8
133=144	12	60	30.4	1.8	27.0	33.1
145=156	13	32	31.6	1.9	28.5	34.9

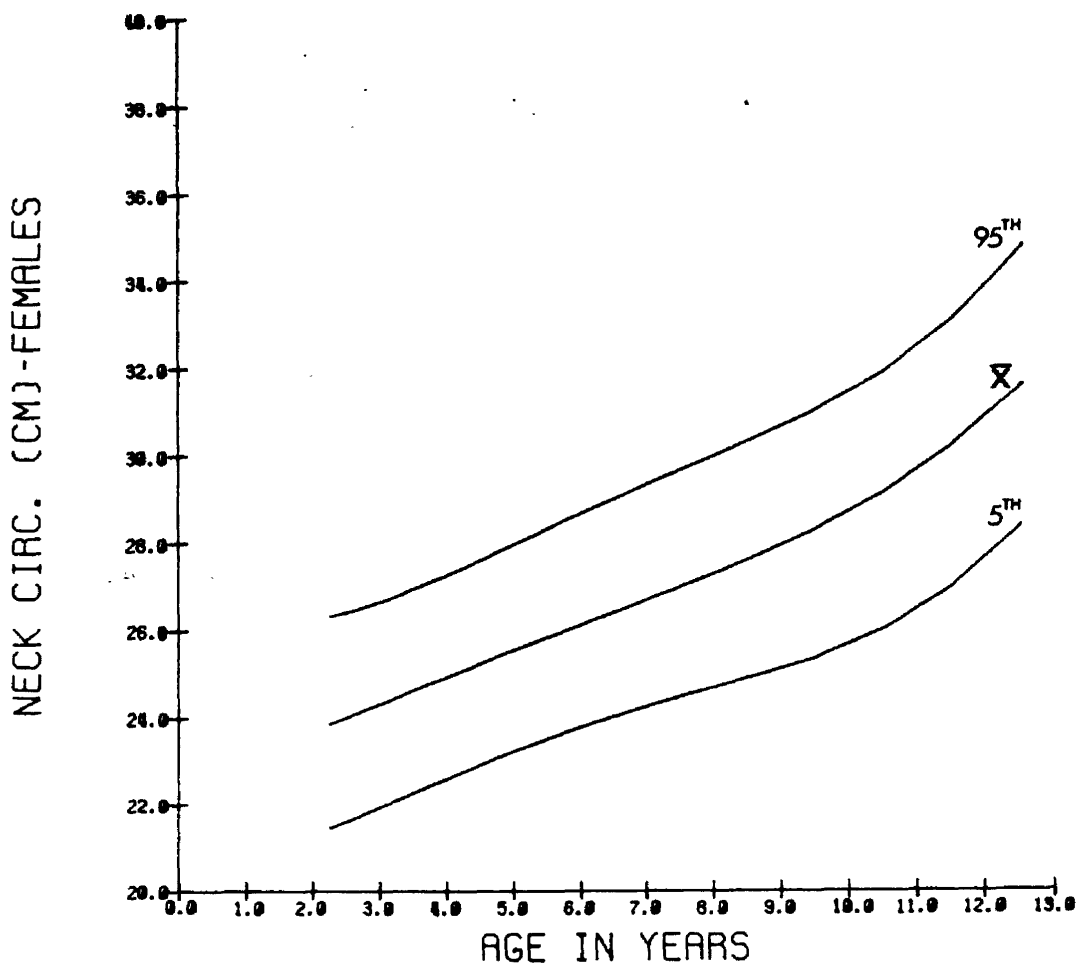

NECK CIRCUMFERENCE, IN CMS. - MALES

AGE(MO/YRS)	N	MEAN	S.D.	5%	50%	95%
25= 30	27	24.3	0.9	22.3	24.2	25.7
31= 36 3	45	25.0	1.3	22.4	25.0	27.2
37= 42	128	25.3	1.2	23.2	25.2	27.3
43= 48 4	122	25.4	1.3	23.0	25.2	27.3
49= 54	171	25.9	1.3	23.4	25.8	28.0
55= 60 5	151	26.2	1.5	23.5	26.1	28.7
61= 66	125	26.7	1.3	24.8	26.6	29.1
67= 72 6	90	27.0	1.1	25.0	27.1	28.6
73= 78	74	27.0	1.3	24.6	27.0	28.9
79= 84 7	73	28.1	1.6	25.5	27.8	30.0
85= 96 8	133	28.1	1.5	25.9	27.9	30.5
97=108 9	128	28.9	1.6	26.0	28.8	31.5
109=120 10	106	29.2	1.5	26.4	29.2	31.6
121=132 11	99	30.5	1.6	27.7	30.4	33.5
133=144 12	52	31.0	1.5	28.3	31.0	33.5
145=156 13	21	31.3	1.6	28.7	31.0	33.4

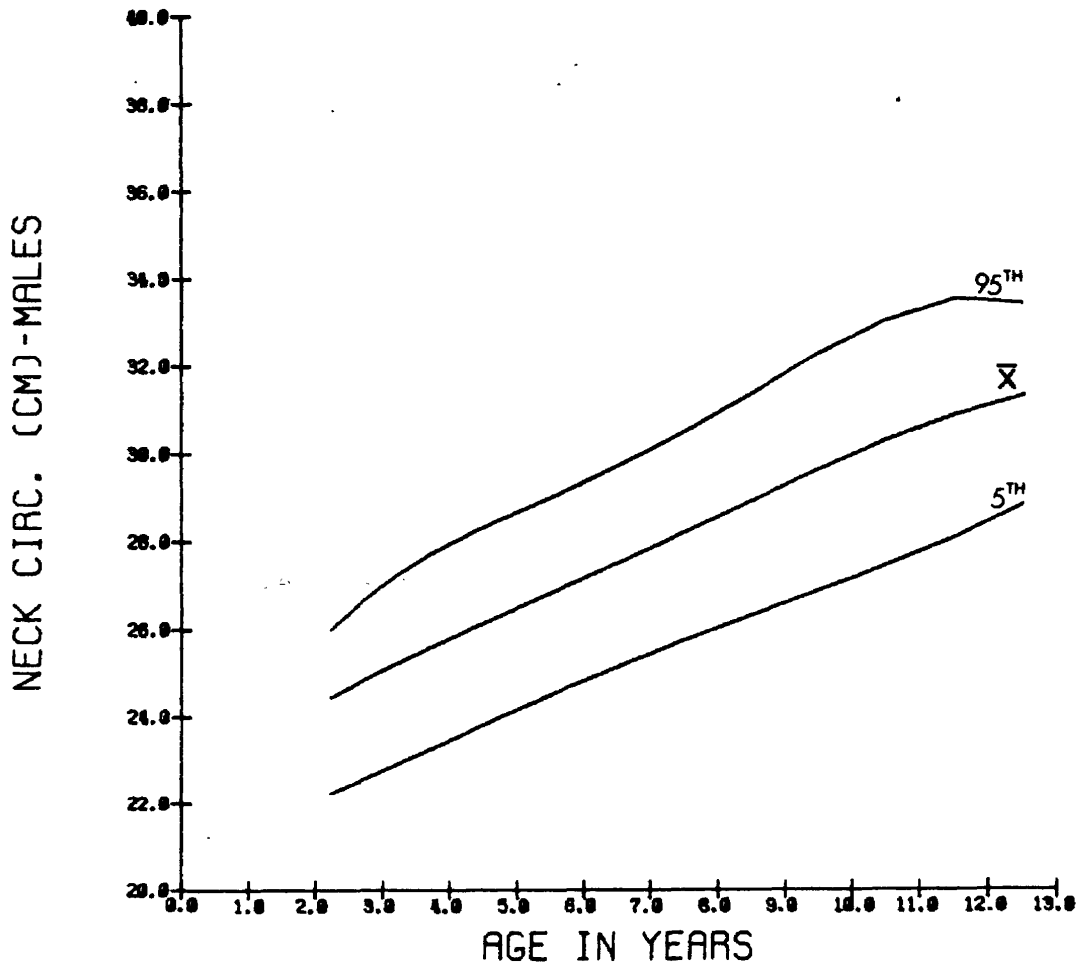

## CHEST CIRCUMFERENCE

Device: Automated tape device. Measurements are recorded automatically at constant tension by computer.

Description: INFANT: Infant lies on back. Measure the horizontal circumference of the chest during normal breathing at the level of the nipples with an automated tape device that applies constant tension. An assistant is required to assure that the infant is in the correct position.

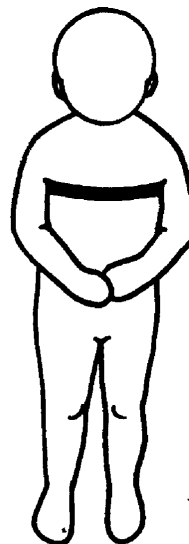

Description: CHILD: Child stands erect, arms hanging slightly away from side. Measure the horizontal circumference of the chest during normal breathing at the level of the nipples with an automated tape device that applies constant tension.

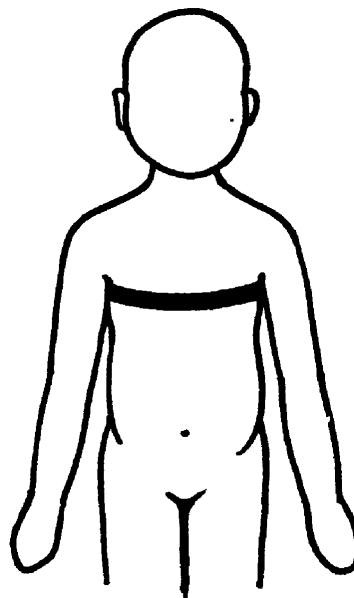

CHEST CIRCUMFERENCE, IN CMS, - COMBINED SEXES

AGE (MO/YRS)	N	MEAN	S.D.	5%	50%	95%
0= 3	128	35.9	3.0	31.7	36.0	41.2
4= 6	88	41.1	2.4	37.3	40.9	44.7
7= 9	46	44.2	2.0	40.1	44.5	47.2
10= 12 1	35	45.1	2.5	40.8	44.7	49.1
13= 18	40	46.1	2.5	42.6	46.0	49.7
19= 24 2	66	48.2	2.3	44.7	47.9	52.3
25= 30	63	49.0	2.2	45.8	48.9	53.6
31= 36 3	101	50.0	2.6	45.9	49.7	54.2
37= 42	260	50.9	2.3	46.7	50.8	54.6
43= 48 4	285	51.7	2.2	48.1	51.5	55.3
49= 54	353	52.8	2.5	48.6	52.6	57.1
55= 60 5	320	53.9	2.7	49.7	53.8	58.2
61= 66	239	54.8	3.1	50.3	54.3	60.2
67= 72 6	167	55.6	3.2	51.1	55.1	60.2
73= 78	166	56.4	3.2	51.5	55.8	62.3
79= 84 7	160	57.9	3.3	52.5	57.6	63.2
85= 96 8	273	59.4	4.4	53.6	58.8	68.6
97=108 9	261	61.8	4.4	56.0	60.9	70.4
109=120 10	239	63.9	4.7	57.6	62.9	72.9
121=132 11	181	67.4	5.5	59.7	66.4	79.2
133=144 12	99	70.4	5.5	63.1	70.0	80.2
145=156 13	39	74.7	7.0	66.1	73.4	87.1

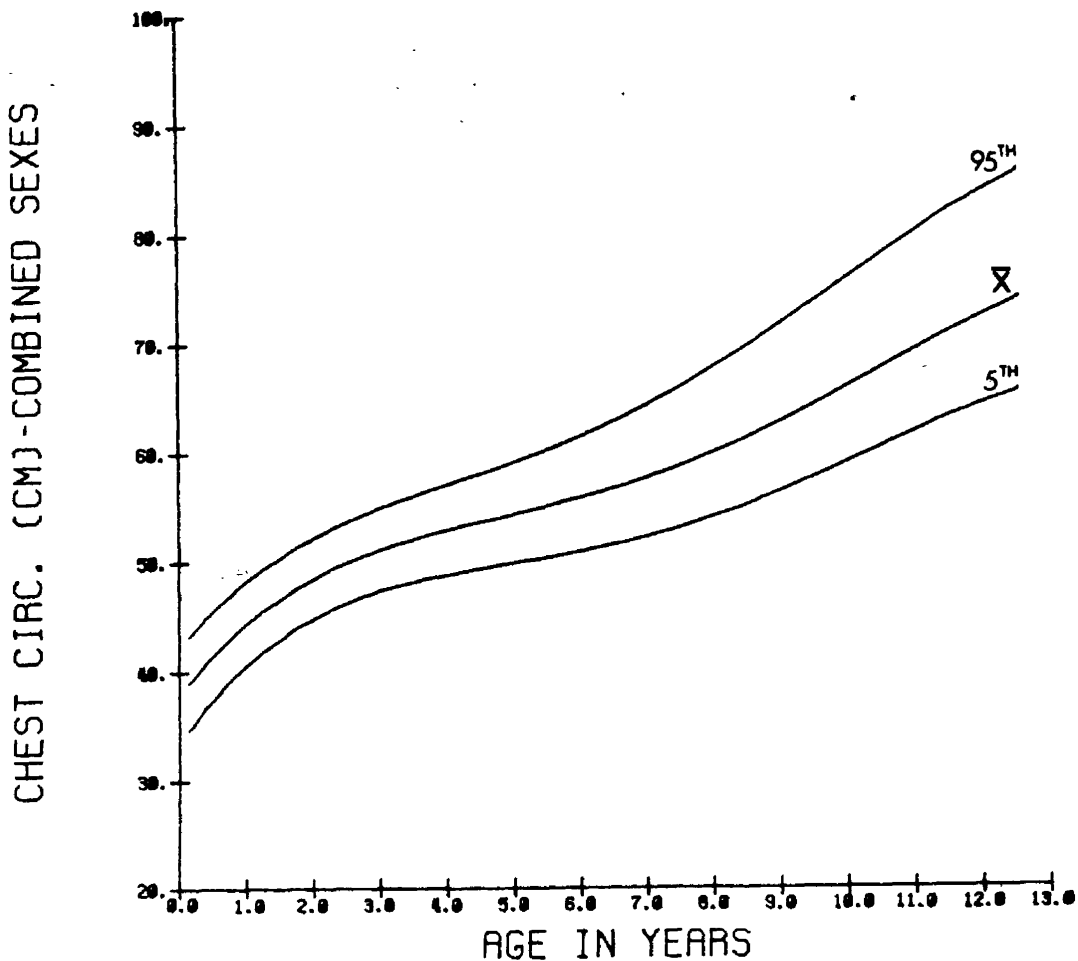



CHEST CIRCUMFERENCE, IN CMS. - FEMALES

AGE(MO/YRS)	N	MEAN	S.D.	5%	50%	95%
0= 3	60	35.9	2.5	32.0	36.0	40.2
4= 6	52	40.5	2.4	35.8	40.3	44.3
7= 9	25	43.5	1.6	39.8	43.6	45.2
10= 12 1	19	44.2	2.2	40.8	44.4	49.2
13= 18	18	44.7	1.8	41.2	44.4	47.4
19= 24 2	28	47.6	2.4	43.9	46.8	52.0
25= 30	30	48.0	2.5	45.1	48.6	53.9
31= 36 3	53	49.1	2.4	44.8	48.8	53.0
37= 42	136	50.4	2.4	45.9	50.3	54.2
43= 48 4	164	51.3	2.3	47.9	51.2	55.3
49= 54	183	52.1	2.2	48.3	51.9	55.6
55= 60 5	168	53.1	2.7	49.2	52.7	57.4
61= 66	114	54.0	3.4	49.5	53.2	58.9
67= 72 6	77	54.8	3.1	50.3	54.4	58.1
73= 78	92	55.8	3.4	51.3	54.9	62.4
79= 84 7	87	56.9	2.9	51.9	57.0	62.1
85= 96 8	141	58.5	4.3	53.0	57.7	68.2
97=108 9	133	61.3	4.8	54.7	60.3	71.1
109=120 10	134	63.7	5.1	57.4	62.5	74.2
121=132 11	82	67.2	6.5	58.3	66.3	79.5
133=144 12	45	70.2	6.5	60.3	69.2	81.2
145=156 13	18	78.3	7.4	68.6	76.7	95.7

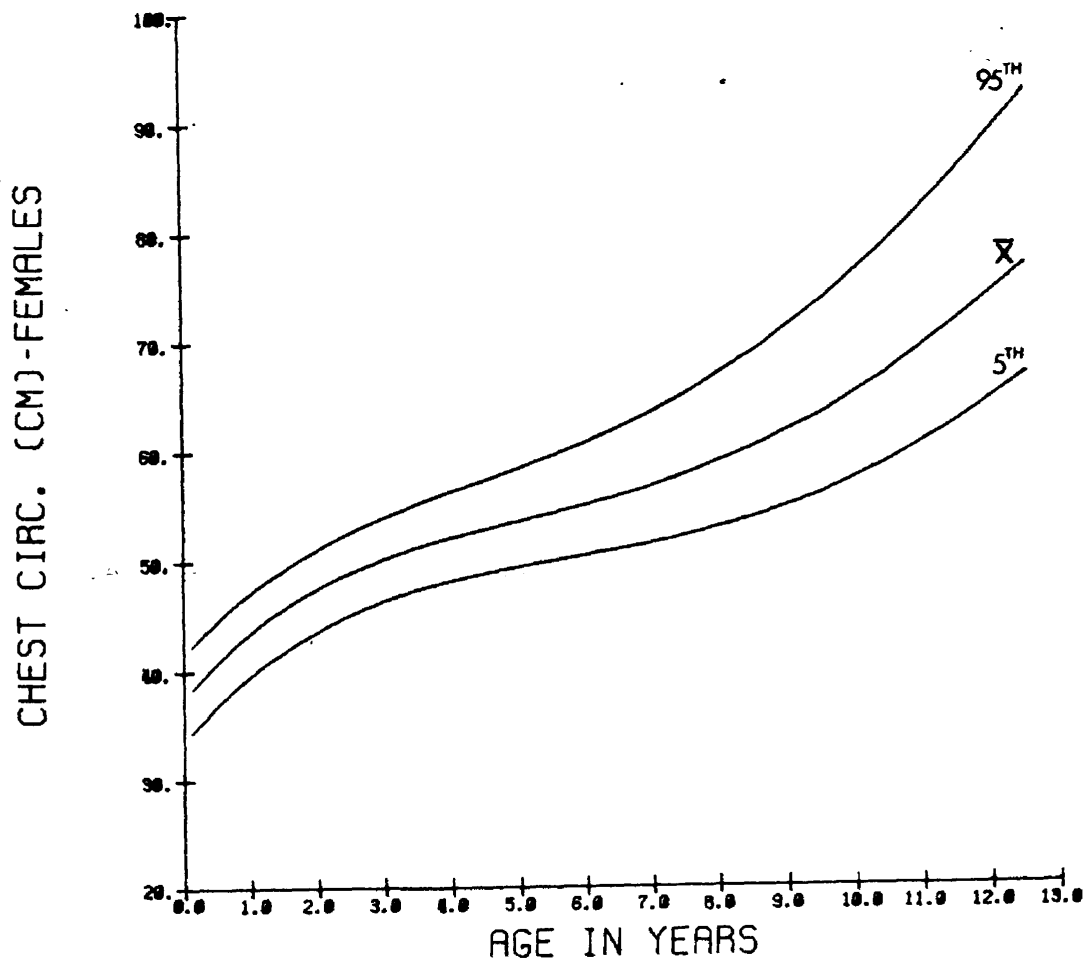

CHEST CIRCUMFERENCE, IN CMS. - MALES

AGE(MO/YRS)	N	MEAN	S.D.	5%	50%	95%
0= 3	68	35.9	3.4	30.1	35.5	41.9
4= 6	36	42.0	2.1	38.7	41.9	45.5
7= 9	21	45.2	2.0	40.4	45.0	48.7
10= 12 1	16	46.2	2.3	43.0	45.0	50.9
13= 18	22	47.2	2.4	43.0	47.5	51.3
19= 24 2	38	48.6	2.2	45.6	48.3	52.2
25= 30	33	49.2	2.0	46.0	49.0	52.5
31= 36 3	48	51.0	2.3	47.4	51.0	54.8
37= 42	124	51.4	2.0	48.1	51.3	54.7
43= 48 4	121	52.2	2.1	48.3	52.1	55.3
49= 54	170	53.6	2.6	49.7	53.4	58.3
55= 60 5	152	54.7	2.6	50.3	55.0	59.0
61= 66	125	55.5	2.7	51.6	55.0	60.3
67= 72 6	90	56.2	3.2	51.5	56.0	60.4
73= 78	74	57.1	2.7	52.5	56.9	62.3
79= 84 7	73	59.2	3.4	53.9	58.9	63.9
85= 96 8	132	60.5	4.3	54.3	60.0	68.6
97=108 9	128	62.4	4.0	56.9	61.6	69.5
109=120 10	105	64.1	4.3	57.8	63.4	71.8
121=132 11	99	67.6	4.6	61.5	66.4	79.2
133=144 12	54	70.6	4.4	63.9	70.7	77.6
145=156 13	21	71.6	4.9	64.8	70.4	79.8

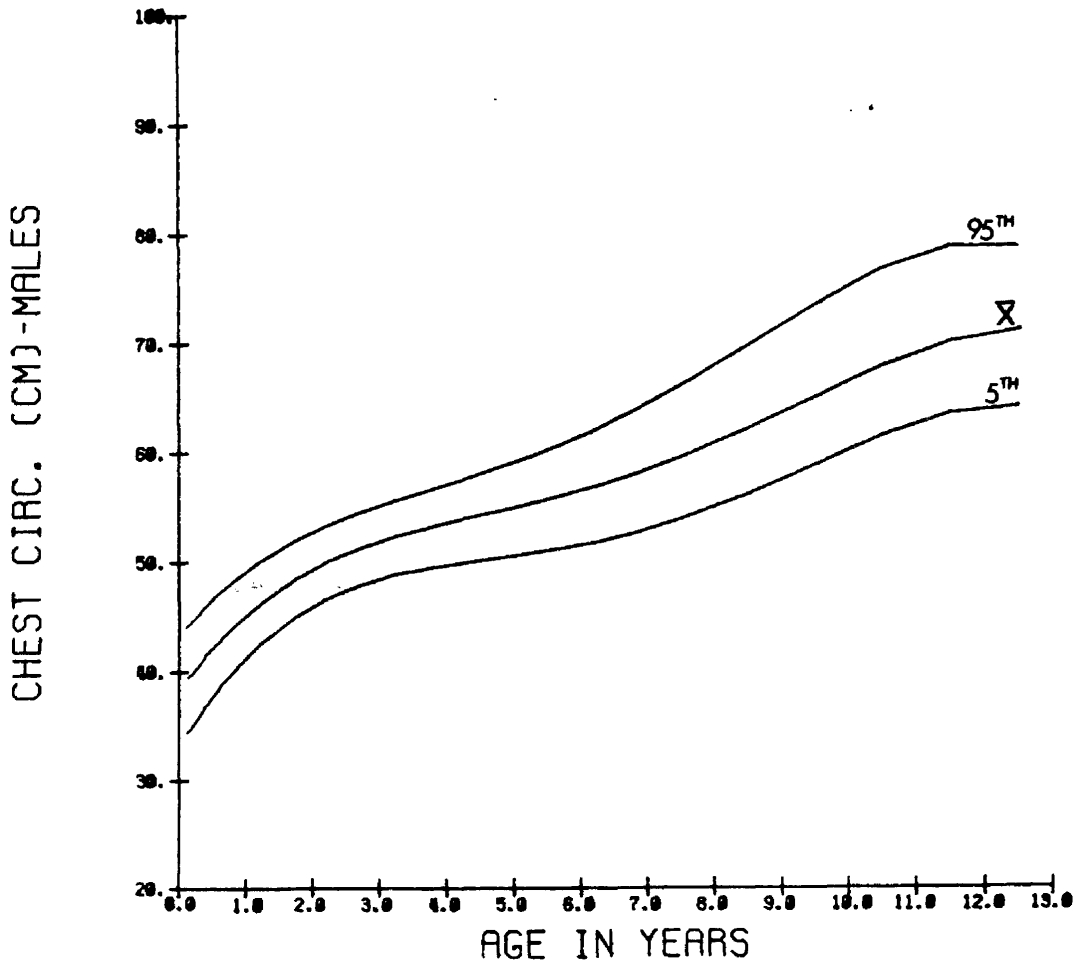

## WAIST CIRCUMFERENCE

Device: Automated tape device. Measurements are recorded automatically at constant tension by computer.

Description: INFANT: Infant lies on back with legs fully extended. Measure the horizontal circumference just below the level of the iliac crest and above the level of the greater trochanter with an automated tape device that applies constant tension. An assistant is required to assure that the infant is in the correct position.

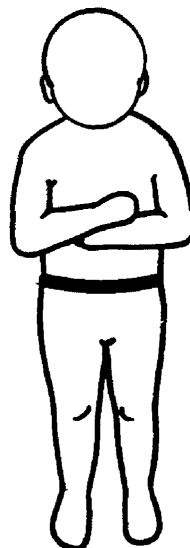

Description: CHILD: Child stands erect, arms hanging at side. Measure the horizontal circumference at the level of the natural waist with an automated tape device that applies constant tension.

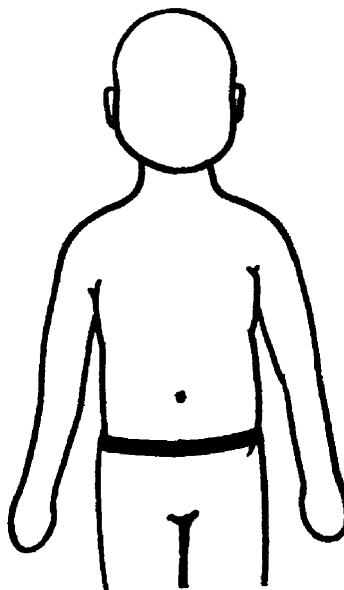

WAIST CIRCUMFERENCE, IN CMS. - COMBINED SEXES

AGE(MO/YRS)	N	MEAN	S.D.	5%	50%	95%
0= 3	126	30.8	3.5	25.7	30.4	36.4
4= 6	86	36.6	2.6	31.8	36.6	41.2
7= 9	43	39.2	2.5	34.1	39.6	43.4
10= 12 1	32	39.2	2.9	34.2	38.4	43.7
13= 18	38	41.1	2.7	36.2	41.4	45.0
19= 24 2	61	44.3	3.4	39.1	44.0	49.5
25= 30	62	46.4	2.5	42.5	46.3	51.2
31= 36 3	99	47.4	3.0	42.5	47.3	52.7
37= 42	259	48.2	2.7	43.9	48.2	53.1
43= 48 4	286	48.6	2.6	43.9	48.5	52.5
49= 54	350	49.1	2.6	45.1	49.2	53.5
55= 60 5	323	50.0	3.1	44.7	49.7	55.7
61= 66	240	50.6	3.4	45.5	50.5	56.3
67= 72 6	166	50.7	3.8	45.0	50.5	56.7
73= 78	165	51.4	3.3	46.6	50.9	56.7
79= 84 7	163	52.6	3.6	46.6	52.4	58.3
85= 96 8	273	53.6	4.6	47.0	52.9	62.0
97=108 9	265	55.3	4.9	48.5	54.4	64.6
109=120 10	249	56.7	5.2	49.5	55.6	66.6
121=132 11	194	59.5	5.5	51.7	58.6	71.3
133=144 12	112	61.1	5.3	53.8	60.2	69.8
145=156 13	43	63.5	6.4	54.1	62.0	75.6

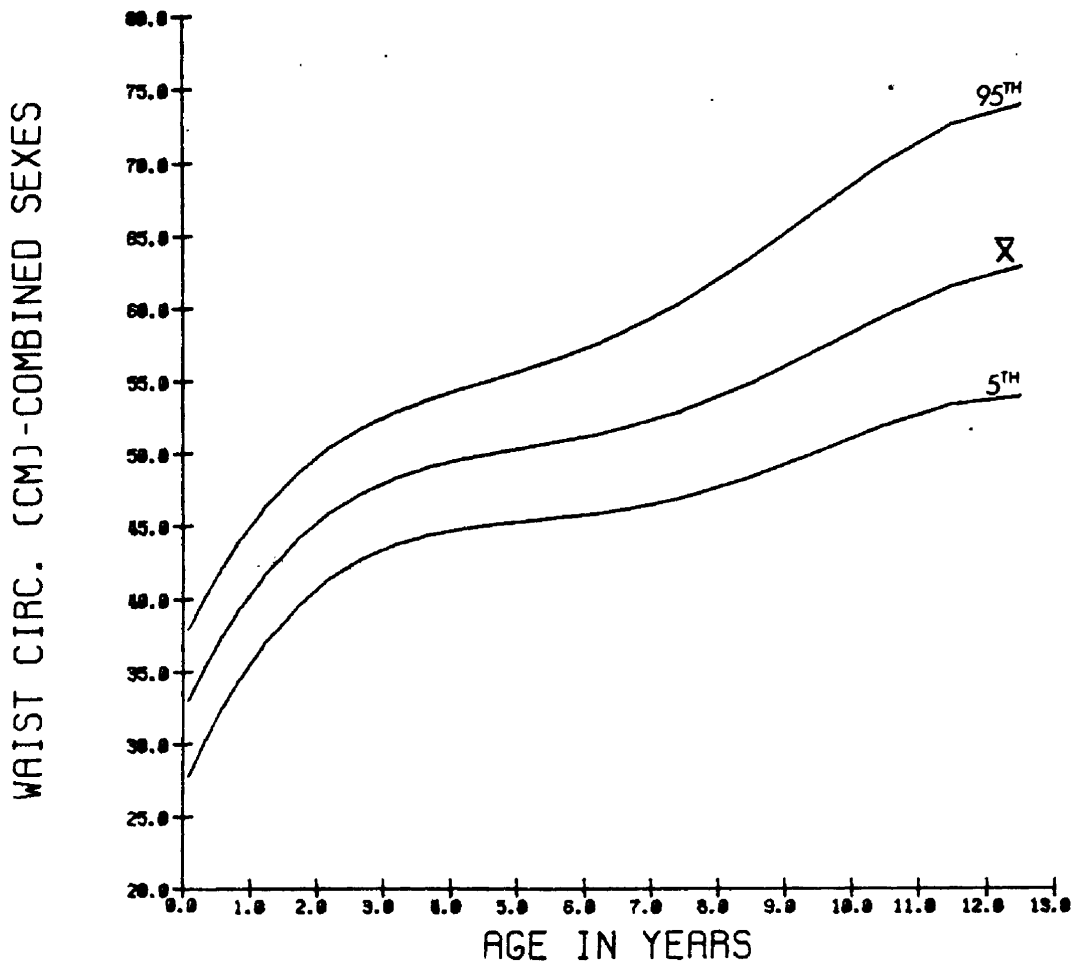

WAIST CIRCUMFERENCE, IN CMS. - FEMALES

AGE(MO/YRS)	N	MEAN	S.D.	5%	50%	95%
0= 3	57	31.0	3.3	25.9	30.5	35.4
4= 6	50	36.3	2.7	31.7	36.2	40.7
7= 9	25	38.8	2.8	33.6	39.4	43.3
10= 12 1	18	39.0	2.7	35.5	38.1	45.0
13= 18	17	39.9	2.4	36.6	39.5	44.5
19= 24 2	27	43.9	3.4	37.6	44.1	49.2
25= 30 3	29	46.4	3.2	41.3	45.9	52.3
31= 36 3	52	46.7	3.1	41.4	46.5	52.7
37= 42 4	136	47.8	2.6	43.6	47.9	52.2
43= 48 4	166	48.1	2.5	43.7	48.1	52.1
49= 54 5	182	48.5	2.4	44.8	48.4	52.6
55= 60 5	171	49.4	3.1	44.4	49.1	55.1
61= 66 6	115	49.9	3.4	45.2	49.7	55.2
67= 72 6	77	49.9	3.8	44.7	49.9	54.0
73= 78 7	92	50.8	3.8	45.7	50.1	57.7
79= 84 8	90	51.7	3.1	46.5	51.7	56.8
85= 96 8	142	52.8	4.4	47.0	51.9	61.6
97=108 9	136	54.6	5.2	47.9	53.5	65.8
109=120 10	144	56.1	5.5	49.0	54.7	68.5
121=132 11	96	58.7	5.7	50.9	57.4	69.2
133=144 12	58	60.3	5.8	52.7	59.2	70.4
145=156 13	22	64.0	7.0	53.9	62.5	75.6

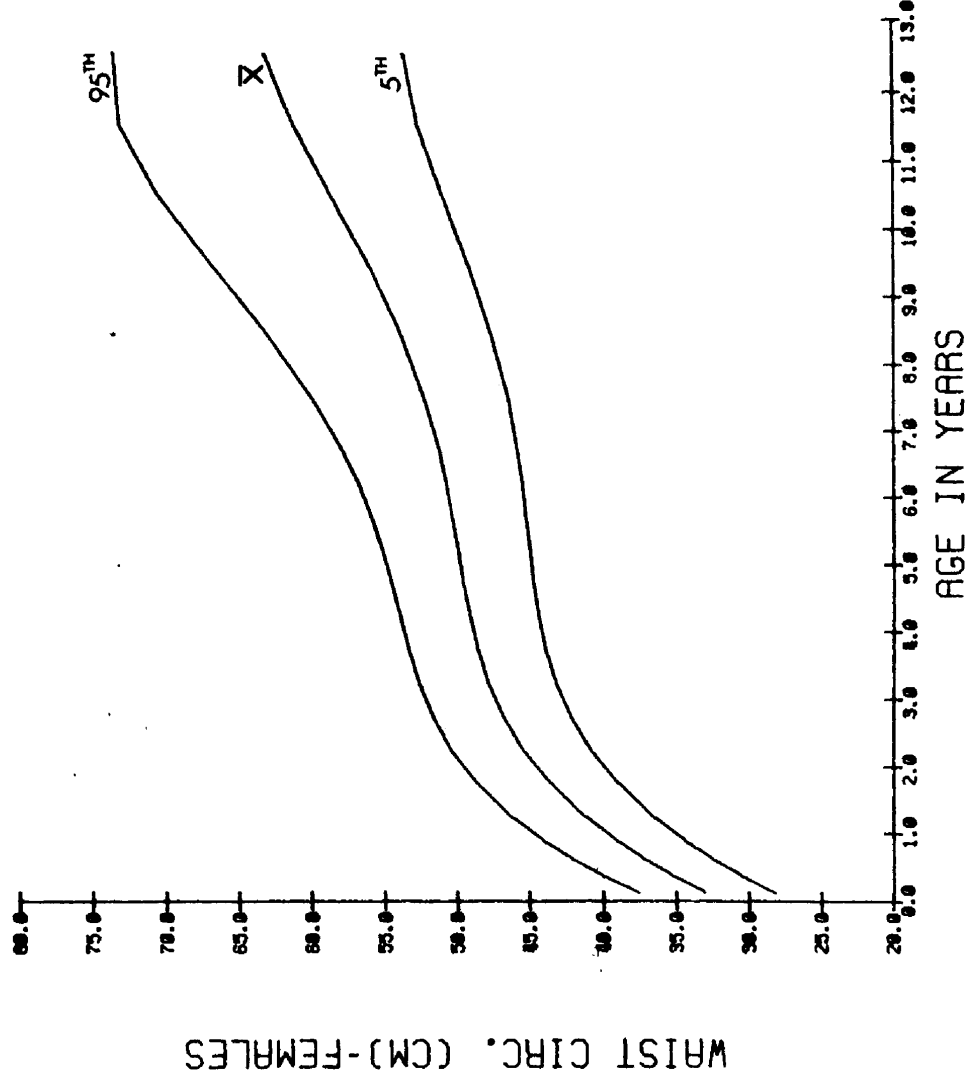

WAIST CIRCUMFERENCE, IN CMS. - MALES

AGE(MO/YRS)	N	MEAN	S.D.	5%	50%	95%
0= 3	69	30.7	3.6	25.1	29.9	37.0
4= 6	36	37.0	2.5	32.5	36.7	41.0
7= 9	18	39.7	2.2	35.4	39.9	43.5
10= 12 1	14	39.5	3.1	32.4	39.6	44.2
13= 18	21	42.0	2.6	35.9	41.9	45.2
19= 24 2	34	44.7	3.4	39.4	43.9	49.0
25= 30	33	46.4	1.8	43.2	46.6	49.5
31= 36 3	47	48.2	2.7	44.0	47.9	52.6
37= 42	123	48.7	2.8	44.1	48.7	54.0
43= 48 4	120	49.3	2.5	45.1	49.2	53.5
49= 54	168	49.8	2.7	45.4	49.9	54.2
55= 60 5	152	50.7	2.9	45.7	50.7	56.1
61= 66	125	51.2	3.2	46.1	51.1	56.5
67= 72 6	89	51.4	3.8	45.5	51.2	57.0
73= 78	73	52.1	2.4	47.8	51.9	55.7
79= 84 7	73	53.6	3.8	47.2	53.3	59.3
85= 96 8	131	54.5	4.6	48.4	53.7	62.3
97=108 9	129	56.0	4.4	49.1	55.4	62.8
109=120 10	105	57.5	4.7	50.2	56.8	66.1
121=132 11	98	60.3	5.1	53.8	59.2	72.3
133=144 12	54	61.9	4.6	54.8	61.6	68.0
145=156 13	21	63.0	5.8	53.9	61.4	74.0

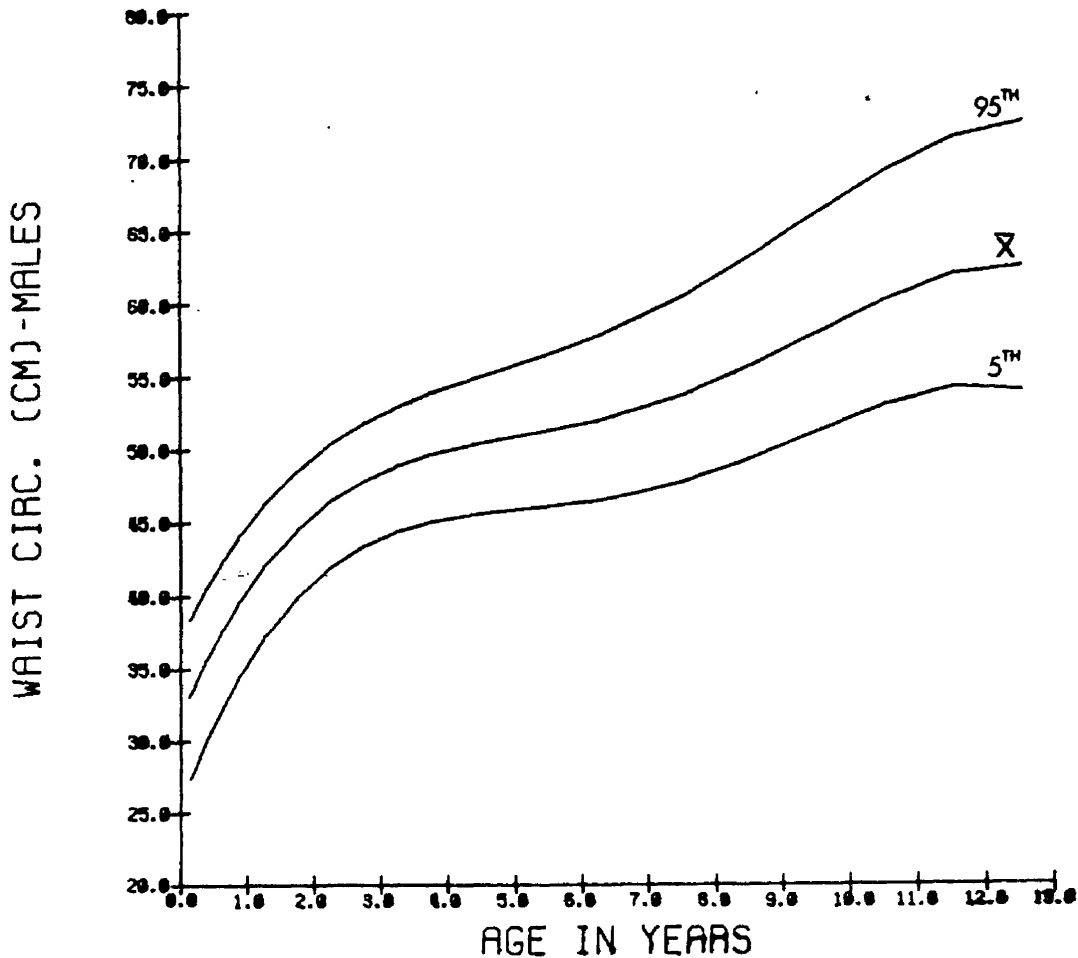

## FOREARM CIRCUMFERENCE

Device: Automated tape device. Measurements are recorded automatically at constant tension by computer.

Description: INFANT: Infant lies on back with right arm extended. Measure the maximum circumference perpendicular to the long axis of the limb with an automated tape device that applies constant tension. An assistant is required to assure that the infant is in the correct position.

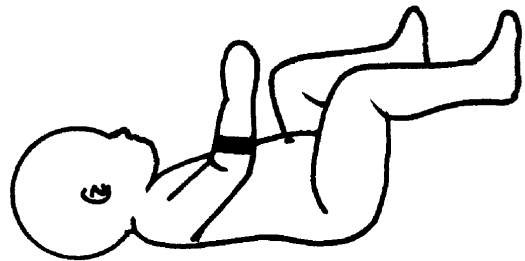

Description: CHILD: Child sits erect with right arm extended. Measure the maximum circumference, perpendicular to the long axis of the limb with an automated tape device that applies a constant tension.

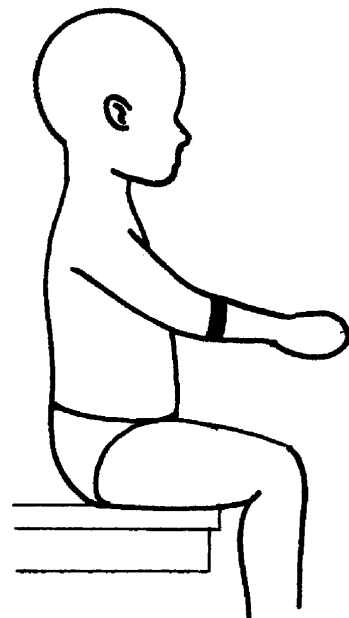
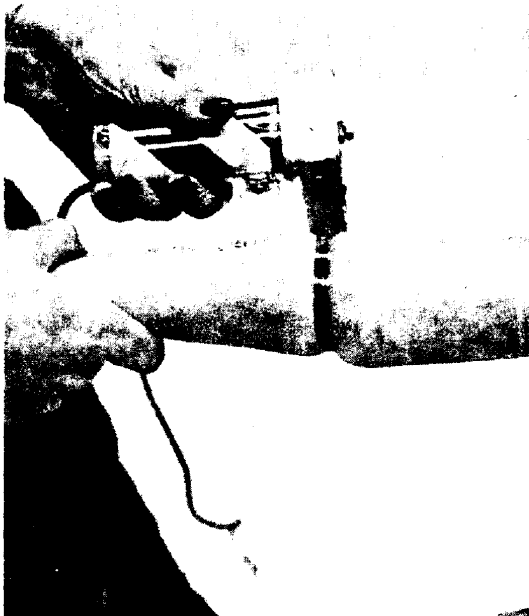

FOREARM CIRCUMFERENCE, IN CMS. - COMBINED SEXES

AGE(MO/YRS)	N	MEAN	S.D.	5%	50%	95%
0= 3	135	11.1	1.4	8.8	11.1	13.2
4= 6	95	13.1	1.1	10.4	13.2	14.5
7= 9	52	13.9	1.1	11.8	13.9	15.7
10= 12 1	42	14.0	1.0	12.2	13.9	15.9
13= 18	53	14.3	1.1	12.1	14.3	16.0
19= 24 2	69	15.0	1.1	13.0	14.9	16.8
25= 30	64	15.0	0.9	13.1	15.0	16.4
31= 36 3	101	15.1	1.0	12.8	15.1	16.8
37= 42	266	15.4	1.0	13.6	15.3	17.0
43= 48 4	286	15.6	1.0	14.0	15.5	17.2
49= 54	354	15.7	1.0	14.1	15.7	17.4
55= 60 5	325	16.1	1.1	14.1	15.9	18.1
61= 66	239	16.3	1.1	14.2	16.2	18.1
67= 72 6	172	16.5	1.2	14.7	16.4	18.8
73= 78	167	16.8	1.2	14.8	16.7	18.9
79= 84 7	162	17.2	1.2	15.1	17.0	19.1
85= 96 8	278	17.6	1.4	15.3	17.4	20.1
97=108 9	273	18.3	1.4	15.9	18.2	20.9
109=120 10	255	18.9	1.5	16.7	18.6	21.8
121=132 11	202	19.9	1.6	17.3	19.8	22.8
133=144 12	115	20.6	1.5	17.5	20.6	23.3
145=156 13	53	21.4	1.5	18.8	21.2	24.0

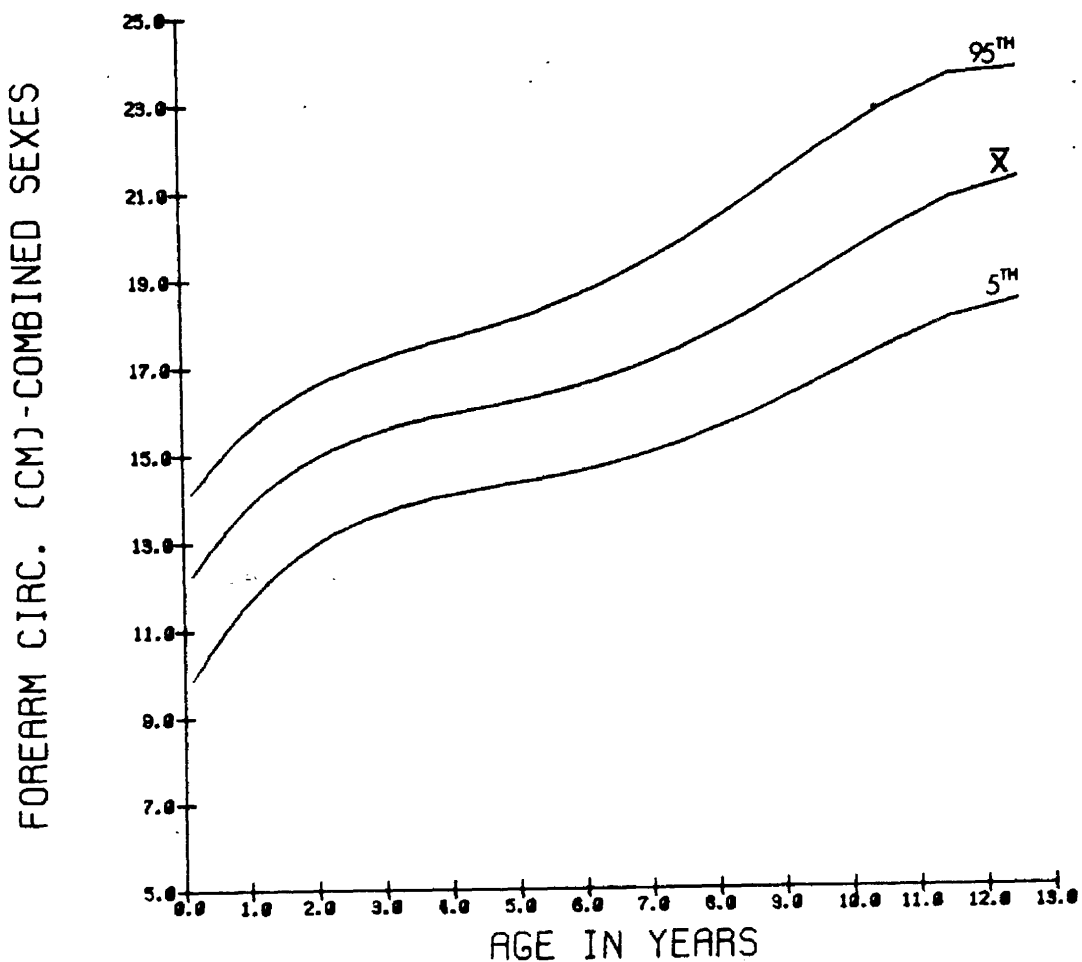



FOREARM CIRCUMFERENCE, IN CMS. - FEMALES

AGE(MO/YRS)	N	MEAN	S.D.	5%	50%	95%
0= 3	62	11.2	1.3	8.9	11.1	13.1
4= 6	54	12.9	1.2	10.3	13.0	14.4
7= 9	29	13.6	0.9	11.8	13.5	14.8
10= 12 1	22	13.8	1.0	12.1	13.7	16.0
13= 18	24	14.2	1.1	12.1	14.1	15.6
19= 24 2	28	14.6	0.9	12.6	14.5	16.2
25= 30	31	15.1	0.8	13.6	15.2	16.5
31= 36 3	54	14.8	1.1	12.5	14.9	16.3
37= 42	138	15.2	1.0	13.3	15.2	16.8
43= 48 4	165	15.5	1.0	13.9	15.3	17.1
49= 54	184	15.5	0.9	13.8	15.5	17.0
55= 60 5	171	15.9	1.2	14.0	15.8	17.7
61= 66	114	16.1	1.2	14.0	16.0	18.0
67= 72 6	80	16.3	1.1	14.7	16.1	18.2
73= 78	92	16.6	1.2	14.6	16.5	18.4
79= 84 7	98	16.7	1.0	15.8	16.8	18.3
85= 96 8	145	17.4	1.3	15.2	17.2	19.6
97=108 9	144	18.0	1.5	15.6	17.9	20.8
109=120 10	149	18.7	1.5	16.4	18.4	21.8
121=132 11	104	19.6	1.7	17.2	19.5	22.4
133=144 12	62	20.3	1.7	17.4	20.0	23.3
145=156 13	32	21.6	1.3	19.2	21.4	23.9

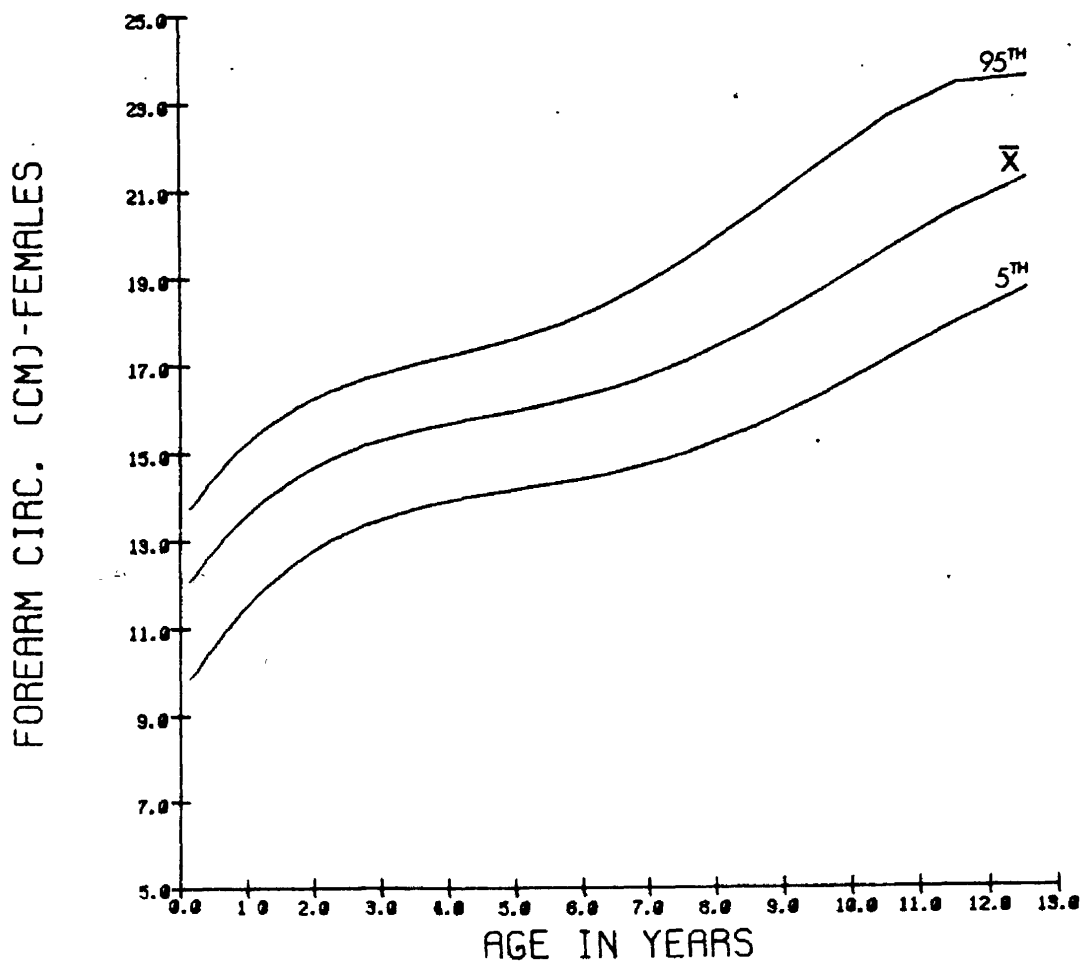

FOREARM CIRCUMFERENCE, IN CMS. - MALES

AGE(MO/YRS)	N	MEAN	S.D.	5%	50%	95%
0= 3	73	11.0	1.5	8.4	11.1	13.4
4= 6	41	13.4	0.8	11.3	13.3	14.5
7= 9	23	14.2	1.2	11.5	14.1	15.8
10= 12 1	20	14.3	1.0	12.2	14.0	16.0
13= 18	29	14.4	1.1	12.0	14.3	16.1
19= 24 2	41	15.3	1.1	13.5	15.3	17.0
25= 30	33	14.8	0.9	12.8	14.9	16.1
31= 36 3	47	15.4	0.9	13.5	15.3	16.9
37= 42	128	15.5	1.0	13.8	15.4	17.0
43= 48 4	121	15.7	0.9	14.2	15.6	17.4
49= 54	170	16.0	1.0	14.3	15.8	17.6
55= 60 5	154	16.2	1.1	14.3	16.1	18.2
61= 66	125	16.6	1.0	14.6	16.4	18.1
67= 72 6	92	16.7	1.2	14.6	16.7	18.9
73= 78	75	17.0	1.1	15.1	16.9	19.3
79= 84 7	72	17.7	1.3	15.5	17.6	20.1
85= 96 8	133	17.9	1.5	15.7	17.8	20.5
97=108 9	129	18.6	1.3	16.4	18.4	21.0
109=120 10	106	19.2	1.5	16.9	19.1	21.7
121=132 11	98	20.3	1.5	17.9	20.1	23.0
133=144 12	53	20.9	1.2	18.9	20.8	23.2
145=156 13	21	21.1	1.7	18.8	20.6	24.0

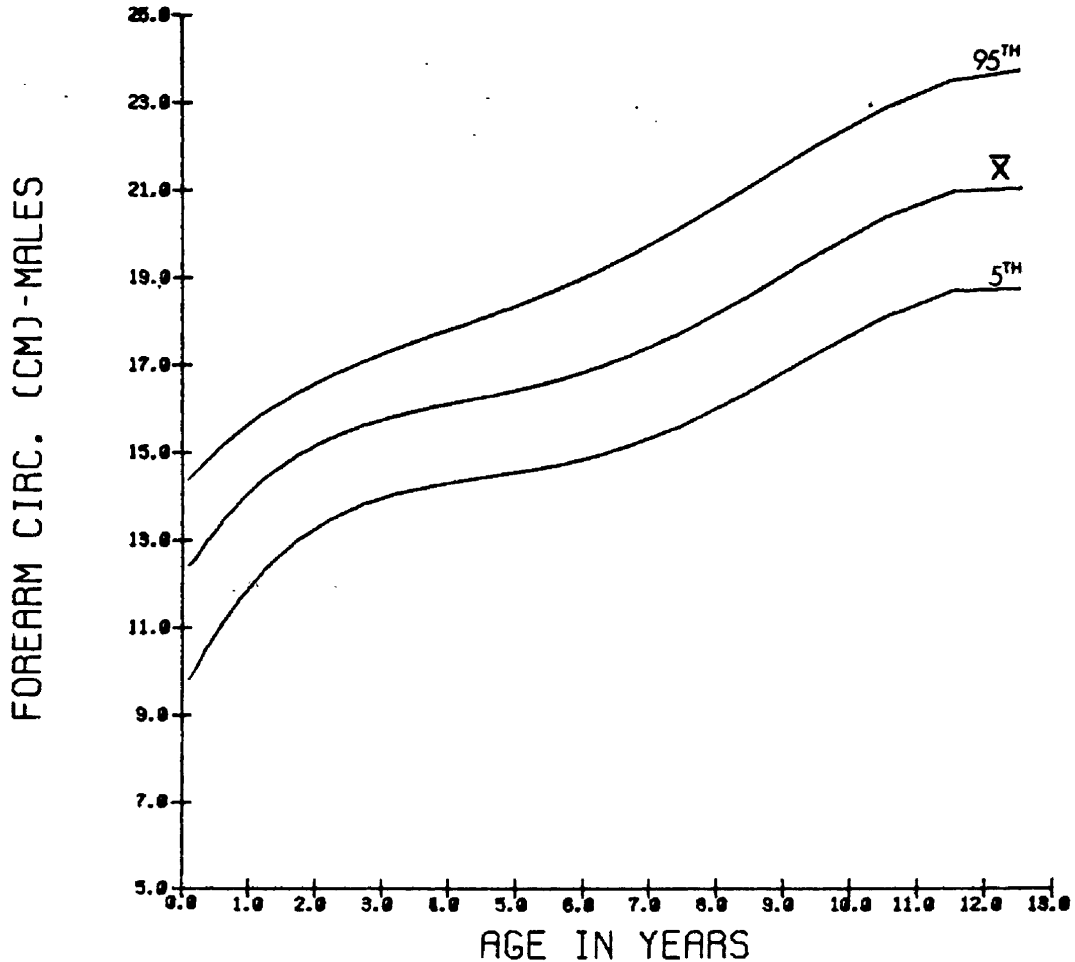

## UPPER ARM CIRCUMFERENCE

Device: Automated tape device. Measurements are recorded automatically at constant tension by computer.

Description: INFANT: Infant lies on back with right arm extended. Measure the circumference perpendicular to the long axis of the limb midway between shoulder and elbow with an automated tape device that applies constant tension. An assistant is required to assure that the infant is in the correct position.

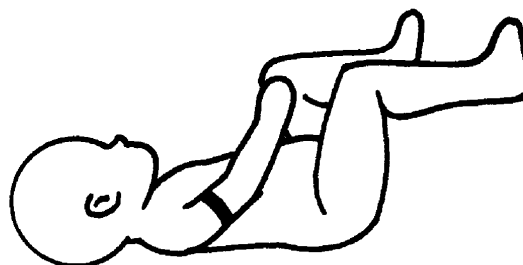

Description: CHILD: Child sits erect with right arm extended. Measure the circumference perpendicular to the long axis of the limb midway between the shoulder and elbow with an automated tape device that applies constant tension.

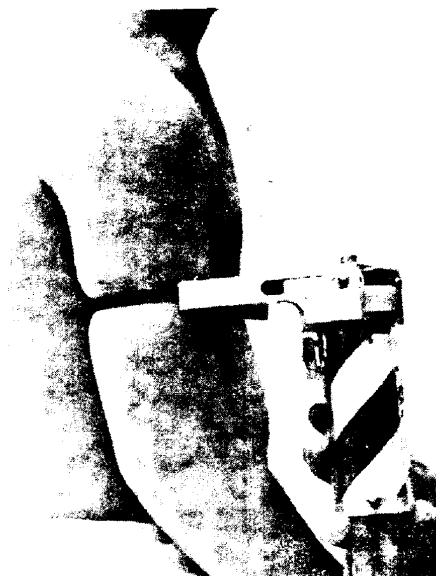

UPPER ARM CIRCUMFERENCE, IN CMS. - COMBINED SEXES

AGE(MO/YRS)	N	MEAN	S.D.	5%	50%	95%
0= 3	136	10.9	1.4	8.4	10.8	13.2
4= 6	96	12.9	1.3	10.1	13.0	14.7
7= 9	51	13.6	1.1	11.4	13.6	15.3
10= 12 1	42	14.0	1.0	12.1	14.0	15.8
13= 18	53	14.2	1.2	11.9	14.1	16.3
19= 24 2	69	14.8	1.2	12.9	14.5	16.8
25= 30	63	15.0	1.1	12.8	14.9	17.2
31= 36 3	101	15.3	1.2	13.1	15.2	17.1
37= 42	261	15.5	1.2	13.6	15.3	17.6
43= 48 4	286	15.6	1.1	14.1	15.5	17.6
49= 54	348	15.9	1.1	14.0	15.8	17.9
55= 60 5	326	16.2	1.2	14.2	16.1	18.3
61= 66	238	16.4	1.4	14.3	16.2	18.5
67= 72 6	172	16.5	1.5	14.3	16.4	19.2
73= 78	166	16.7	1.3	14.5	16.6	18.9
79= 84 7	163	17.2	1.6	14.9	17.0	19.7
85= 96 8	277	17.7	1.9	15.1	17.3	21.8
97=108 9	270	18.3	1.9	15.6	17.9	22.1
109=120 10	254	19.1	2.1	16.2	18.7	23.1
121=132 11	199	20.2	2.3	16.7	19.9	24.6
133=144 12	115	21.2	2.4	17.7	20.7	25.6
145=156 13	52	21.9	2.4	18.4	21.4	26.6

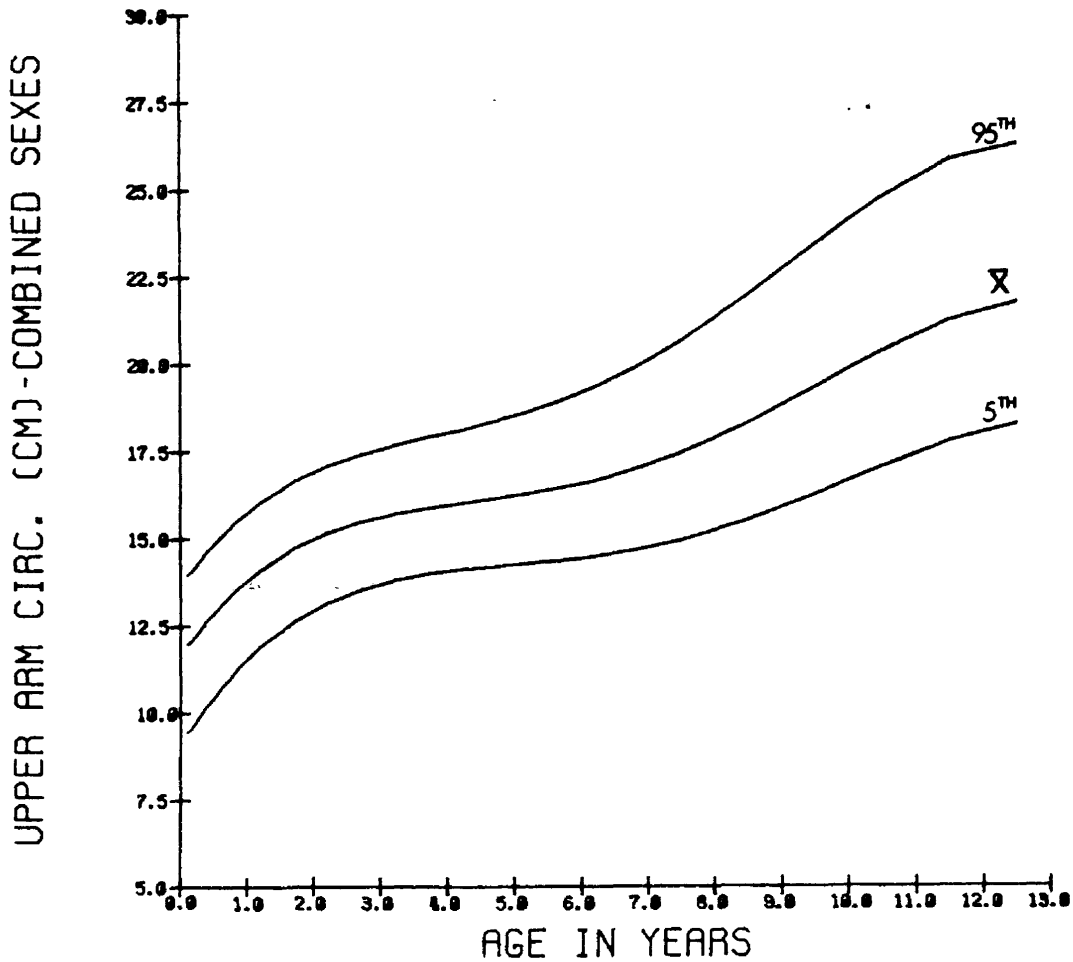

UPPER ARM CIRCUMFERENCE, IN CMS. - FEMALES

AGE (MO/YRS)	N	MEAN	S.D.	5%	50%	95%
0- 3	62	11.0	1.3	8.5	10.8	13.0
4- 6	54	12.7	1.5	9.8	12.7	14.7
7- 9	28	13.5	1.1	11.1	13.5	15.2
10- 12	1	22	13.7	0.9	12.1	14.9
13- 18	24	14.1	1.3	11.9	13.9	16.3
19- 24	2	28	14.4	1.2	12.5	16.4
25- 30	30	15.0	1.2	12.6	15.0	17.2
31- 36	3	53	15.1	1.3	13.0	17.0
37- 42	136	15.4	1.2	13.4	15.3	17.5
43- 48	4	165	15.6	1.0	14.1	17.6
49- 54	183	15.8	1.1	13.9	15.7	17.8
55- 60	5	172	16.2	1.3	14.0	18.5
61- 66	114	16.2	1.6	14.1	15.9	18.7
67- 72	6	81	16.4	1.6	14.3	19.4
73- 78	92	16.6	1.5	14.4	16.7	19.1
79- 84	7	90	16.9	1.4	14.9	19.3
85- 96	8	146	17.6	1.8	15.1	21.3
97-108	9	142	18.2	2.0	15.5	22.1
109-120	10	148	19.1	2.2	16.3	23.4
121-132	11	101	20.0	2.3	16.5	24.6
133-144	12	62	21.3	2.9	16.9	26.5
145-156	13	31	22.2	2.4	18.2	26.6

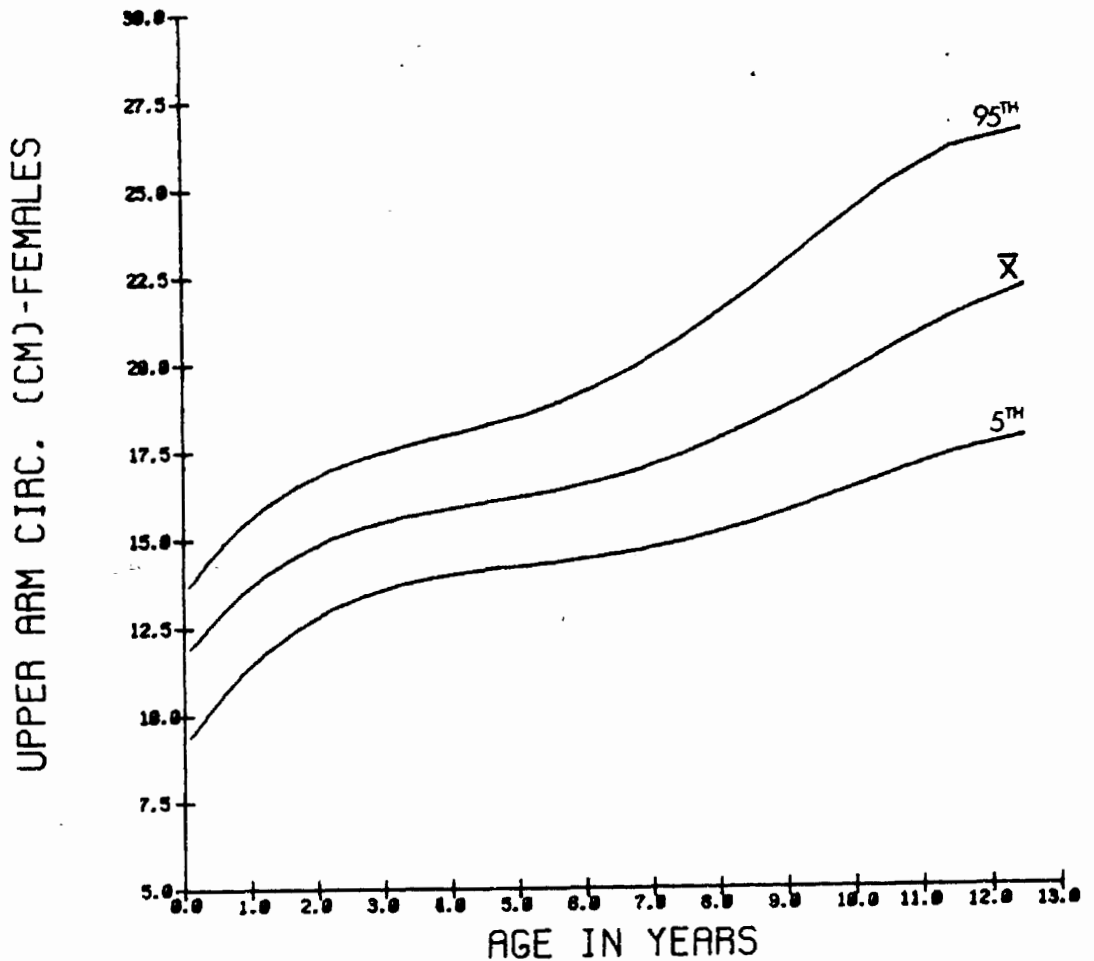

UPPER ARM CIRCUMFERENCE, IN CMS, - MALES

AGE(MO/YRS)	N	MEAN	S.D.	5%	50%	95%	
0= 3	74	10.9	1.5	8.2	11.0	13.2	
4= 6	42	13.1	0.9	10.9	13.1	14.3	
7= 9	23	13.8	1.1	11.7	13.9	15.4	
10= 12	1	20	14.3	1.1	12.0	14.2	16.1
13= 18	29	14.4	1.0	12.2	14.2	16.1	
19= 24	2	41	15.1	1.1	13.3	14.8	16.6
25= 30	33	15.0	1.1	12.8	14.7	16.6	
31= 36	3	48	15.5	1.1	13.1	15.4	17.3
37= 42	125	15.6	1.1	13.7	15.4	17.7	
43= 48	4	121	15.7	1.1	14.0	15.6	17.5
49= 54	165	16.0	1.1	14.2	15.9	18.0	
55= 60	5	154	16.2	1.1	14.3	16.1	18.1
61= 66	124	16.5	1.1	14.7	16.4	18.2	
67= 72	6	91	16.5	1.3	14.2	16.6	18.9
73= 78	74	16.7	1.1	14.5	16.5	18.6	
79= 84	7	73	17.4	1.7	14.7	17.3	20.0
85= 96	8	131	17.8	2.1	15.2	17.4	21.6
97=108	9	128	18.4	1.8	15.8	18.1	22.0
109=120	10	106	19.1	2.0	16.2	18.7	22.6
121=132	11	98	20.4	2.2	17.2	20.1	24.4
133=144	12	53	21.1	1.8	18.2	20.7	24.5
145=156	13	21	21.4	2.5	18.4	20.8	26.2

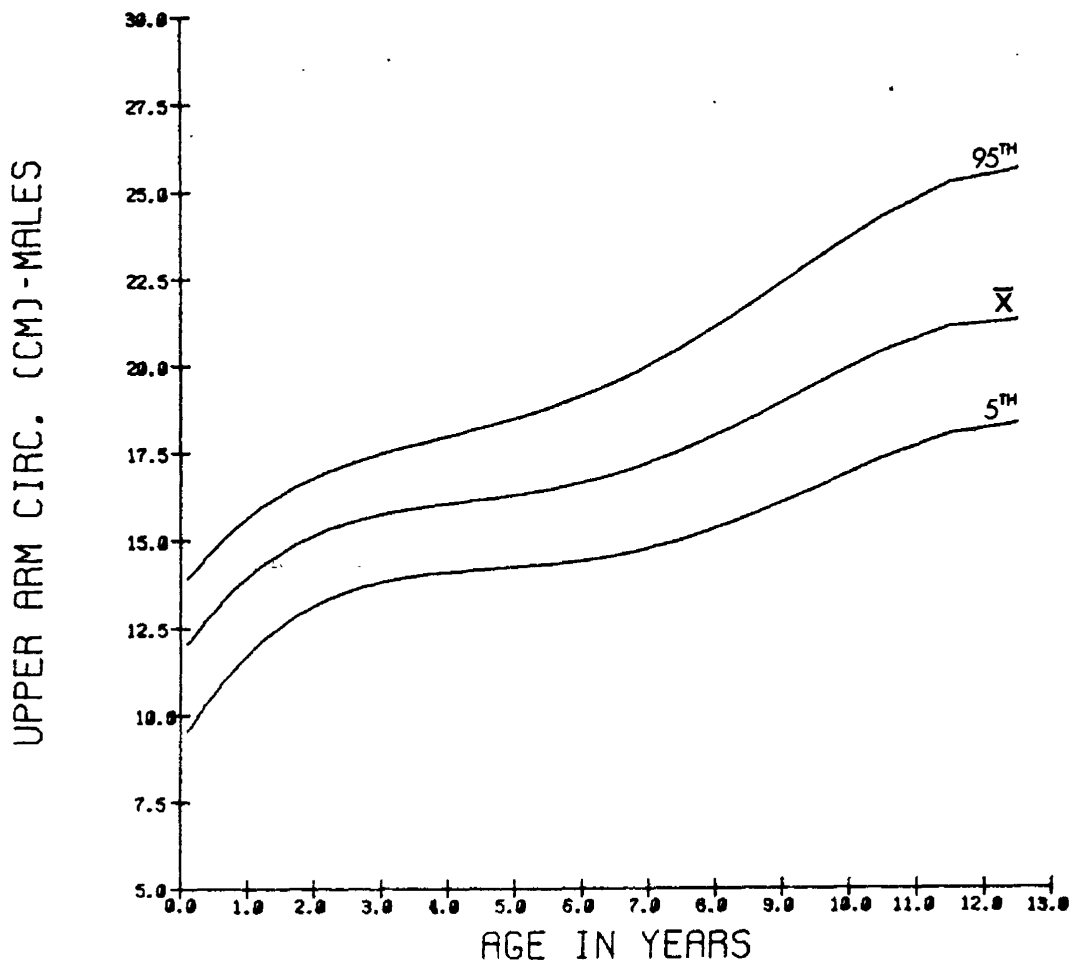

## MID-THIGH CIRCUMFERENCE

Device: Automated tape device. Measurements are recorded automatically at constant tension by computer.

Description: INFANT: Infant lies on back with right leg extended supported free of crib surface. Measure the horizontal circumference midway between the abdomen-thigh flexure crease and the knee with an automated tape device that applies constant tension. An assistant is required to assure that the infant is in the correct position.

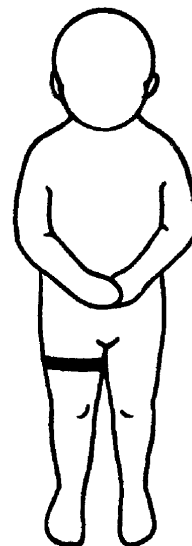
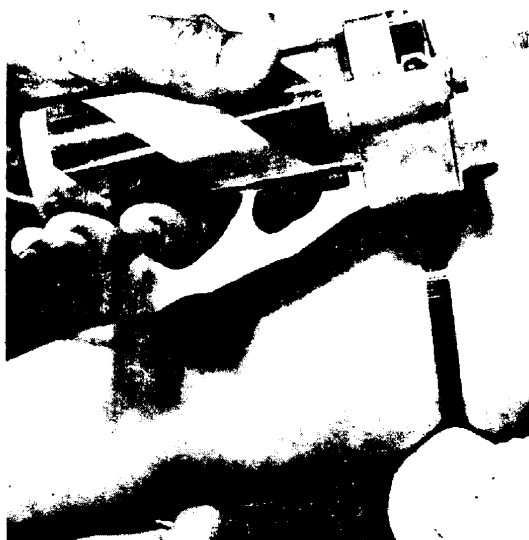

Description: CHILD: Child sits with right leg extended and relaxed. Measure the horizontal circumference midway between the abdomen-thigh flexure crease and the knee with an automated tape device that applies constant tension.

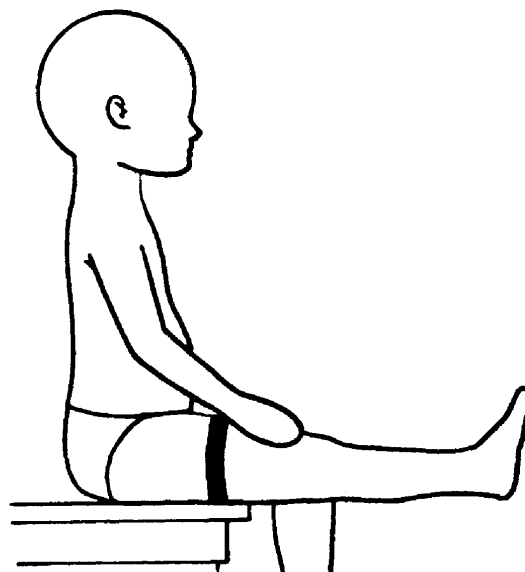
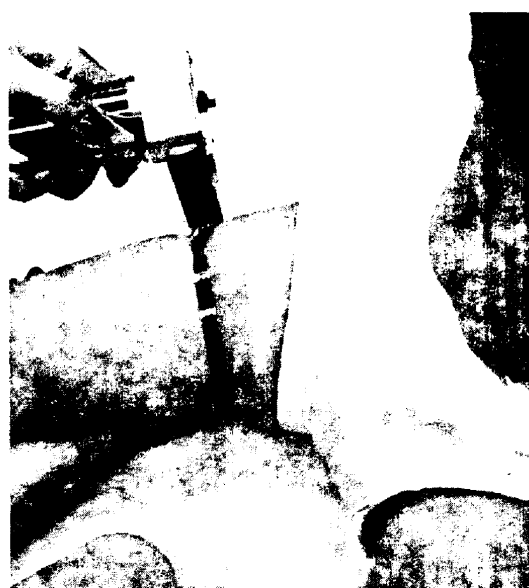

MID-THIGH CIRCUMFERENCE, IN CMS, - COMBINED SEXES

AGE(MO/YRS)	N	MEAN	S.D.	5%	50%	95%
0= 3	134	17.8	2.9	13.9	17.6	22.5
4= 6	94	21.6	2.2	17.1	21.5	25.3
7= 9	53	22.7	2.2	19.0	22.2	26.9
10= 12 1	43	23.5	2.2	20.0	23.6	26.6
13= 18	53	23.6	2.5	19.5	23.5	26.9
19= 24 2	67	25.3	2.1	21.9	25.2	28.2
25= 30	64	25.9	1.8	22.9	25.9	28.6
31= 36 3	98	26.7	2.0	23.0	26.7	30.1
37= 42	256	27.5	2.3	23.7	27.4	31.4
43= 48 4	279	28.9	2.1	24.6	27.9	31.6
49= 54	338	28.8	2.1	25.5	28.7	32.0
55= 60 5	315	29.6	2.3	26.2	29.3	33.7
61= 66	225	30.4	2.5	26.7	30.2	35.0
67= 72 6	166	30.5	2.7	26.6	30.4	35.0
73= 78	156	31.4	2.8	26.8	31.0	36.7
79= 84 7	153	32.5	2.7	27.2	32.4	36.5
85= 96 8	251	33.6	3.5	28.7	33.2	40.6
97=108 9	248	35.5	3.6	30.4	35.0	42.4
109=120 10	226	36.7	3.5	31.5	36.1	43.6
121=132 11	183	39.4	4.2	33.0	39.1	47.9
133=144 12	101	41.0	3.3	35.9	40.6	46.7
145=156 13	49	44.1	4.2	37.9	43.0	52.1

MID THIGH CIRC. (CM) - COMBINED SEXES

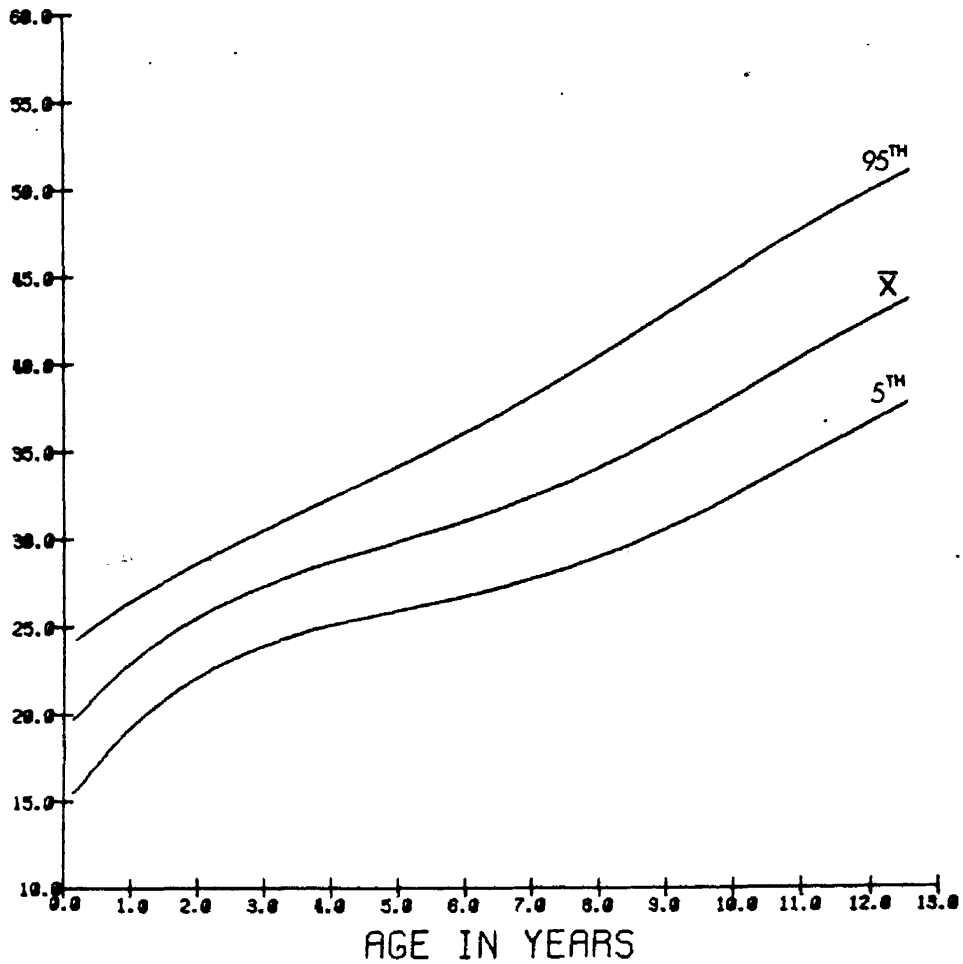



MID-THIGH CIRCUMFERENCE, IN CMS. - FEMALES

AGE(MO/YRS)	N	MEAN	S.D.	5%	50%	95%
0= 3	61	18.0	2.7	13.9	18.2	22.4
4= 6	52	21.4	2.2	17.0	21.1	25.3
7= 9	30	22.6	1.8	19.4	21.9	25.8
10= 12 1	23	23.6	2.6	19.6	23.8	26.6
13= 18	23	23.5	2.3	19.5	23.6	26.9
19= 24 2	27	24.8	2.0	21.1	24.9	27.6
25= 30	30	26.5	2.0	23.1	26.7	29.0
31= 36 3	50	26.6	2.1	22.9	26.2	30.1
37= 42	135	27.7	2.6	23.4	27.3	31.7
43= 48 4	163	28.2	2.0	25.0	27.9	32.0
49= 54	182	29.0	2.1	25.4	28.8	32.1
55= 60 5	167	29.9	2.3	26.3	29.6	34.0
61= 66	112	30.5	2.6	26.5	30.8	35.5
67= 72 6	79	30.7	2.7	26.3	30.7	35.1
73= 78	89	31.6	2.9	27.1	31.3	36.9
79= 84 7	88	32.2	2.5	27.1	32.3	36.2
85= 96 8	136	33.8	3.4	28.8	33.5	40.4
97=108 9	137	35.8	3.7	30.2	35.3	43.1
109=120 10	139	37.2	3.8	30.8	36.5	44.4
121=132 11	99	39.6	4.4	32.9	38.6	48.3
133=144 12	59	41.1	3.5	34.9	40.6	46.8
145=156 13	32	45.2	4.2	38.8	44.3	52.7

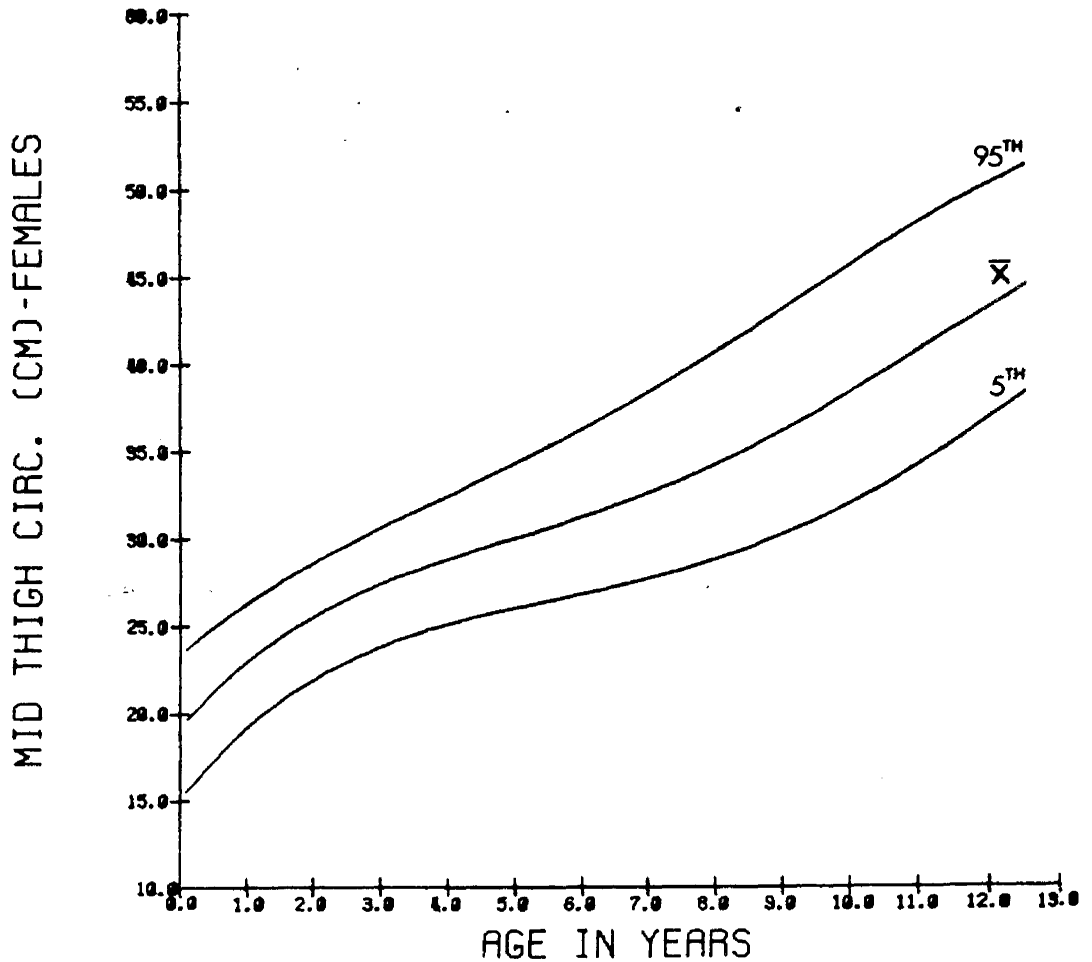

MID-THIGH CIRCUMFERENCE, IN CMS. - MALES

AGE(MO/YRS)	N	MEAN	S.D.	5%	50%	95%
0= 3	73	17.5	3.0	13.6	17.2	22.1
4= 6	42	21.0	2.3	17.2	21.7	25.2
7= 9	23	23.0	2.6	18.3	22.5	27.7
10= 12 1	20	23.3	1.9	20.0	23.3	27.1
13= 18	30	23.6	2.7	16.4	23.4	26.0
19= 24 2	40	25.6	2.1	22.2	25.4	28.3
25= 30	34	25.4	1.6	22.5	25.7	27.9
31= 36 3	48	26.9	2.0	23.2	27.0	30.0
37= 42	121	27.4	1.9	24.0	27.4	30.4
43= 48 4	116	27.9	2.2	24.2	28.0	31.3
49= 54	156	28.6	2.1	25.5	28.5	31.0
55= 60 5	148	29.3	2.2	26.0	29.1	33.0
61= 66	113	30.3	2.2	26.8	30.2	34.3
67= 72 6	87	30.4	2.7	26.5	30.1	34.0
73= 78	67	31.1	2.5	26.7	30.7	35.2
79= 84 7	65	32.0	2.8	27.8	32.5	38.3
85= 96 8	115	33.3	3.6	28.0	32.8	40.7
97=108 9	111	35.2	3.5	30.4	34.5	41.3
109=120 10	87	36.0	2.9	31.6	35.7	41.1
121=132 11	84	39.1	3.9	32.8	39.1	46.5
133=144 12	42	40.9	2.9	36.1	40.4	46.1
145=156 13	17	42.0	3.5	37.7	41.0	49.7

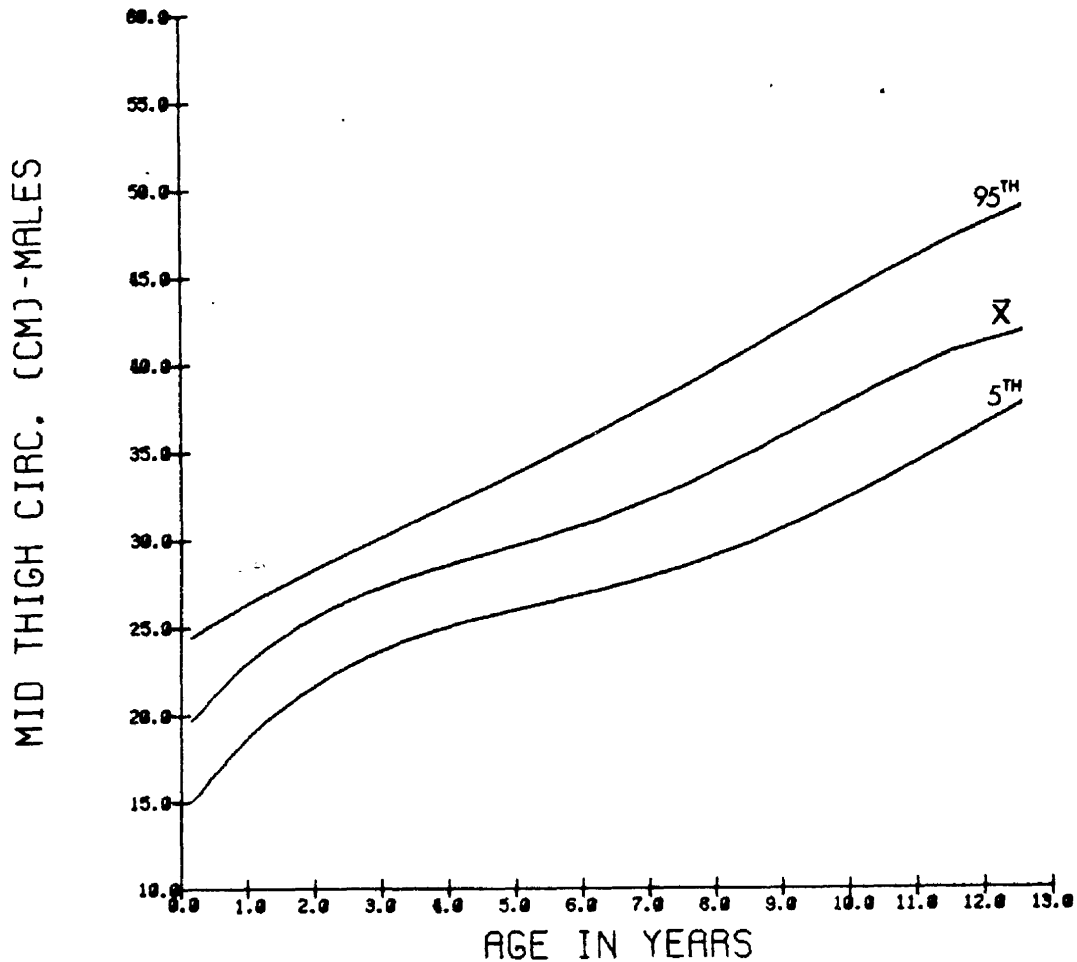

## MAXIMUM CALF CIRCUMFERENCE

Device: Automated tape device. Measurements are recorded automatically at constant tension by computer.

Description: INFANT: Infant lies on back with right leg extended and supported free of crib surface. Measure the maximum horizontal circumference at the level of the greatest posterior protrusion of the calf with an automated tape device that applies constant tension. An assistant is required to assure that the infant is in the correct position.

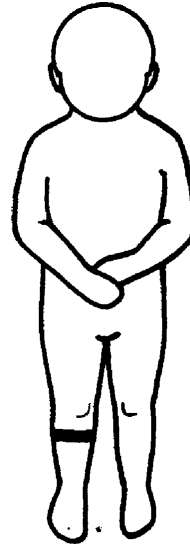
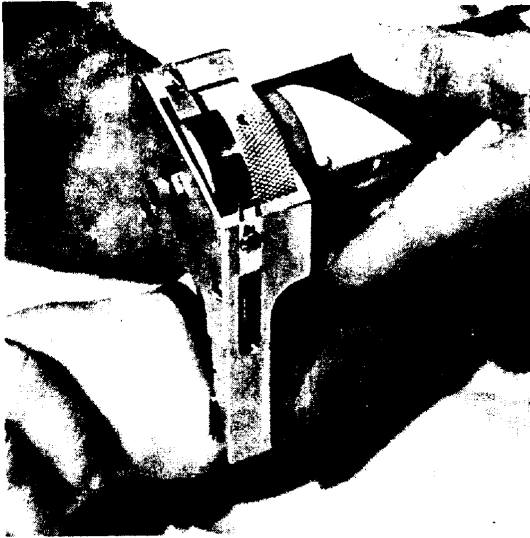

Description: CHILD: Child sits with right leg extended and relaxed. Measure the maximum horizontal circumference at the level of the greatest posterior protrusion of the calf with an automated tape device that applies constant tension.

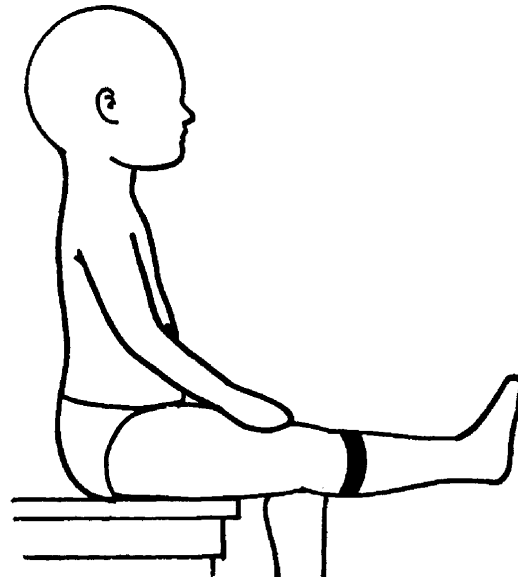

MAXIMUM CALF CIRCUMFERENCE, IN CMS, - COMBINED SEXES

AGE(MO/YRS)	N	MEAN	S.D.	5%	50%	95%
0= 3	135	12.6	1.6	9.7	12.4	15.7
4= 6	97	15.8	1.3	13.1	15.7	18.0
7= 9	53	17.1	1.3	14.9	16.9	19.3
10= 12	1	17.7	1.3	15.5	17.5	19.6
13= 18	54	18.2	1.4	15.6	18.2	20.4
19= 24	2	19.3	1.3	17.3	19.3	21.5
25= 30	64	19.8	1.2	17.6	19.7	21.7
31= 36	3	20.1	1.5	17.9	20.0	22.5
37= 42	265	20.5	1.3	18.1	20.4	22.4
43= 48	4	20.7	1.3	18.7	20.7	23.0
49= 54	353	21.2	1.4	19.1	21.1	23.5
55= 60	5	21.6	1.5	19.1	21.5	24.2
61= 66	237	22.0	1.6	19.6	21.9	24.6
67= 72	6	22.4	1.7	20.1	22.2	25.5
73= 78	164	22.9	1.7	20.2	22.8	25.9
79= 84	7	23.5	1.6	20.8	23.4	26.2
85= 96	8	24.3	2.0	21.3	24.0	27.7
97=108	9	25.5	2.2	22.4	25.2	29.4
109=120	10	25.4	2.2	22.9	26.0	30.6
121=132	11	28.0	2.7	24.1	27.7	32.1
133=144	12	29.0	2.3	25.4	29.1	33.0
145=156	13	30.7	2.6	26.0	30.4	34.6

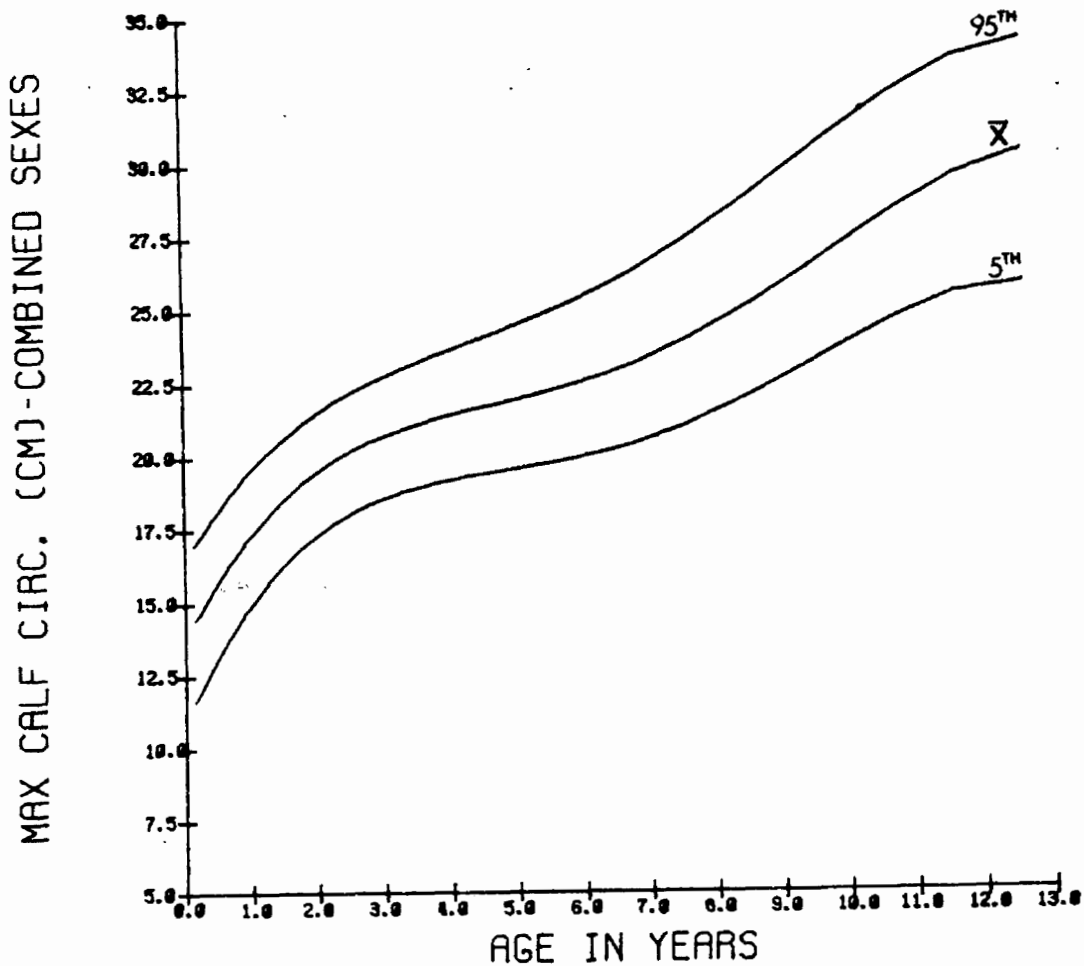

MAXIMUM CALF CIRCUMFERENCE, IN CM, - FEMALES

AGE(MO/YRS)	N	MEAN	S.D.	5%	50%	95%
0- 3	61	12.8	1.8	9.8	12.5	15.7
4- 6	55	15.6	1.3	12.8	15.6	17.8
7- 9	30	17.0	1.3	14.5	16.7	19.3
10- 12	1	23	1.4	14.9	17.3	19.4
13- 18	24	17.9	1.3	15.4	17.8	19.6
19- 24	2	28	1.2	16.0	18.7	20.9
25- 30	30	19.8	1.2	17.7	19.6	21.7
31- 36	3	55	1.7	17.3	19.6	23.3
37- 42	137	20.5	1.4	17.8	20.5	22.7
43- 48	4	166	1.2	18.8	20.6	22.9
49- 54	184	21.2	1.3	18.9	21.0	23.3
55- 60	5	170	1.5	18.9	21.6	24.0
61- 66	114	21.9	1.7	19.1	21.7	24.2
67- 72	6	80	1.8	19.6	22.1	25.3
73- 78	89	22.9	1.8	20.0	22.8	26.1
79- 84	7	89	1.4	20.8	23.1	25.3
85- 96	8	146	1.9	21.1	24.0	27.4
97-108	9	141	2.1	22.5	25.2	29.1
109-120	10	149	2.2	22.6	25.8	30.5
121-132	11	104	2.6	23.8	27.3	31.8
133-144	12	63	2.5	24.8	28.8	33.2
145-156	13	32	2.6	26.7	31.3	35.0

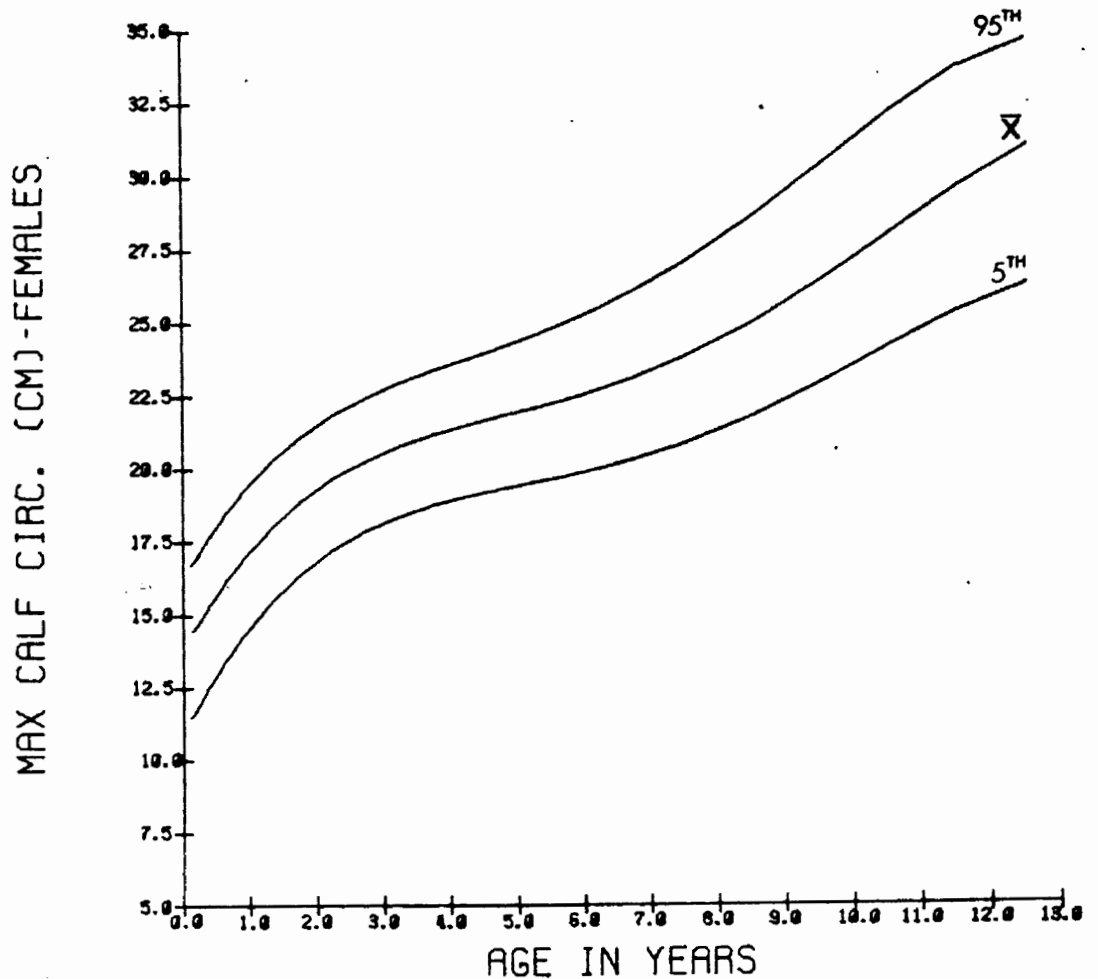

MAXIMUM CALF CIRCUMFERENCE, IN CMS. - MALES

AGE (MO/YRS)	N	MEAN	S.D.	5%	50%	95%
0= 3	74	12.5	1.8	9.4	12.3	15.5
4= 6	42	16.1	1.3	13.4	15.9	18.0
7= 9	23	17.3	1.2	14.8	17.3	19.1
10= 12 1	21	18.0	1.1	15.8	17.6	19.6
13= 18	30	18.5	1.5	16.0	18.4	21.5
19= 24 2	41	19.7	1.3	17.5	19.7	21.8
25= 30	34	19.8	1.2	17.4	19.8	21.5
31= 36 3	48	20.3	1.2	18.1	20.2	22.4
37= 42	128	20.5	1.1	18.4	20.4	22.2
43= 48 4	122	20.8	1.3	18.7	20.7	23.0
49= 54	169	21.3	1.4	19.3	21.1	23.7
55= 60 5	151	21.6	1.5	19.2	21.5	24.4
61= 66	123	22.2	1.4	19.8	22.0	24.8
67= 72 6	92	22.5	1.6	20.2	22.3	25.6
73= 78	75	22.9	1.5	20.4	22.8	25.6
79= 84 7	72	23.9	1.7	21.0	23.7	26.7
85= 96 8	132	24.4	2.2	21.6	24.1	28.1
97=108 9	128	25.6	2.2	22.3	25.2	29.9
109=120 10	105	26.5	2.1	23.2	26.2	30.6
121=132 11	97	28.2	2.8	24.7	27.8	32.1
133=144 12	51	29.1	2.1	25.6	29.1	32.3
145=156 13	20	29.6	2.3	24.2	29.1	34.2

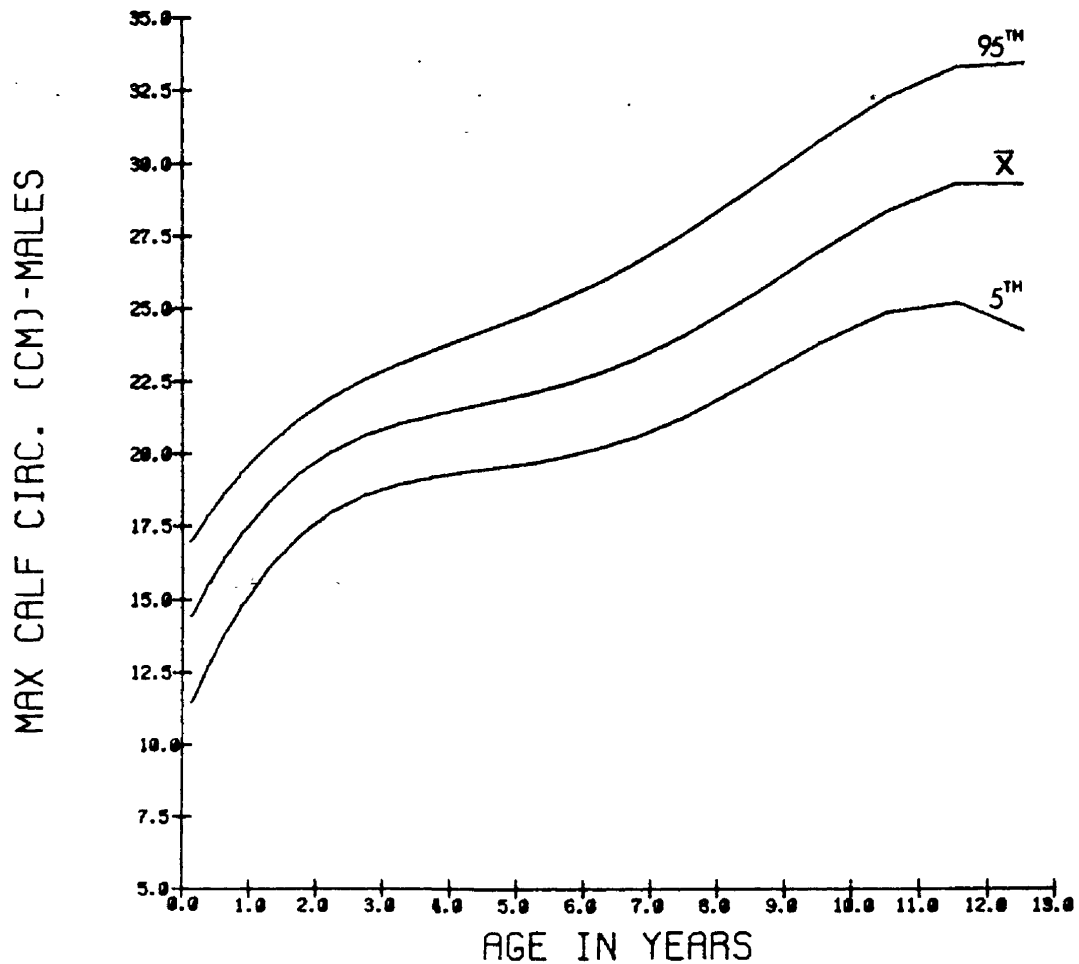

## ANKLE CIRCUMFERENCE

Device: Automated tape device. Measurements are recorded automatically at constant tension by computer.

Description: INFANT: Infant lies on back with right leg extended and supported free of crib surface. Measure the minimum horizontal circumference of the ankle above the malleoli with an automated tape device that applies constant tension. An assistant is required to assure that the infant is in the correct position.

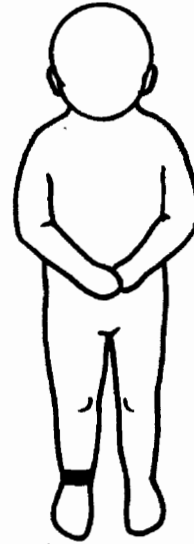
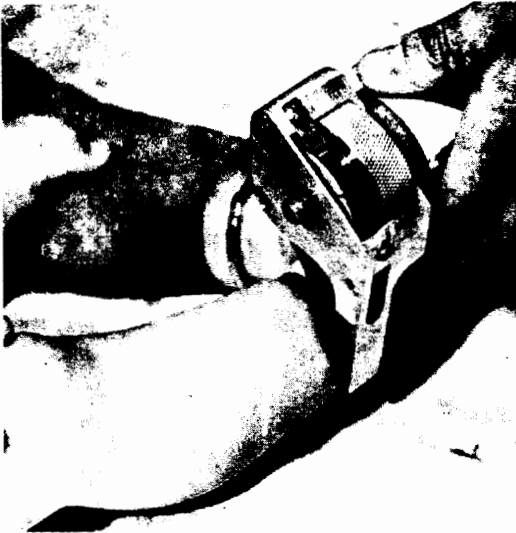

Description: CHILD: Child sits with right leg extended and relaxed. Measure the minimum horizontal circumference of the ankle above the malleoli with an automated tape device that applies constant tension.

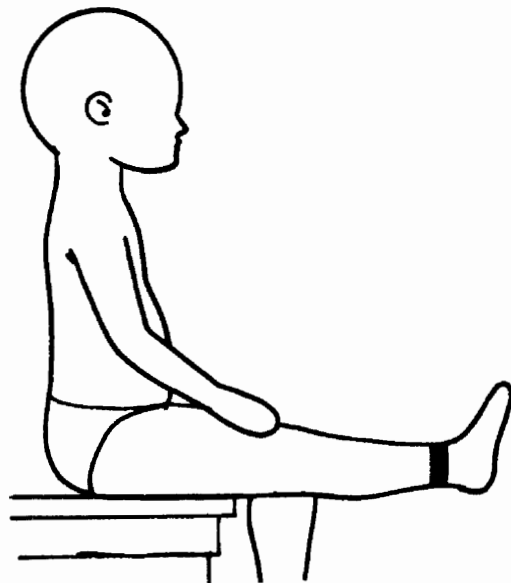
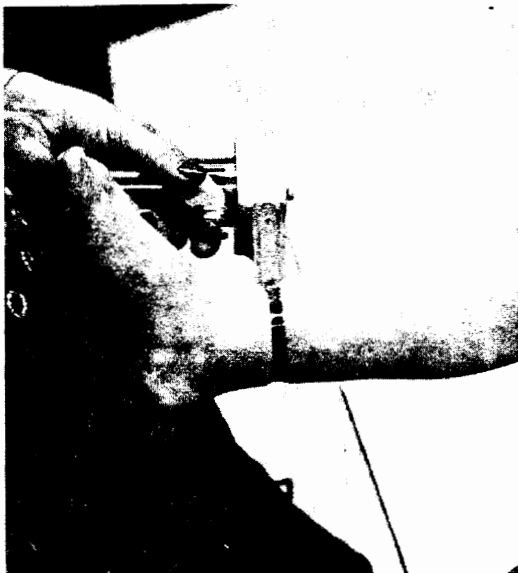

ANKLE CIRCUMFERENCE, IN CMS. - COMBINED SEXES

AGE(MO/YRS)	N	MEAN	S.D.	5%	50%	95%	
0= 3	135	9.9	1.2	7.7	9.7	11.9	
4= 6	96	11.8	1.1	9.9	11.7	13.7	
7= 9	52	12.3	1.1	10.2	12.3	13.9	
10= 12	1	44	12.8	0.8	11.2	12.8	14.8
13= 18	53	13.1	0.8	11.4	13.0	14.4	
19= 24	2	70	13.8	1.1	11.9	13.8	16.0
25= 30	63	14.0	1.0	12.4	13.9	15.5	
31= 36	3	103	13.9	1.0	12.3	13.8	15.6
37= 42	267	14.2	1.0	12.5	14.2	15.7	
43= 48	4	287	14.3	0.9	12.7	14.2	15.8
49= 54	355	14.5	0.9	12.8	14.4	16.1	
55= 60	5	320	14.7	1.1	13.0	14.6	16.6
61= 66	238	14.9	1.1	13.1	14.8	16.8	
67= 72	6	170	15.1	1.1	13.1	15.1	17.0
73= 78	165	15.3	1.1	13.7	15.1	17.3	
79= 84	7	162	15.6	1.1	13.8	15.7	17.3
85= 96	8	278	16.1	1.3	14.1	16.0	18.7
97=108	9	269	16.7	1.3	14.8	16.5	19.2
109=120	10	255	17.3	1.4	14.9	17.3	19.8
121=132	11	199	18.3	1.6	15.8	18.2	21.1
133=144	12	115	18.9	1.4	16.3	18.8	21.1
145=156	13	52	19.8	1.4	17.5	19.9	22.1

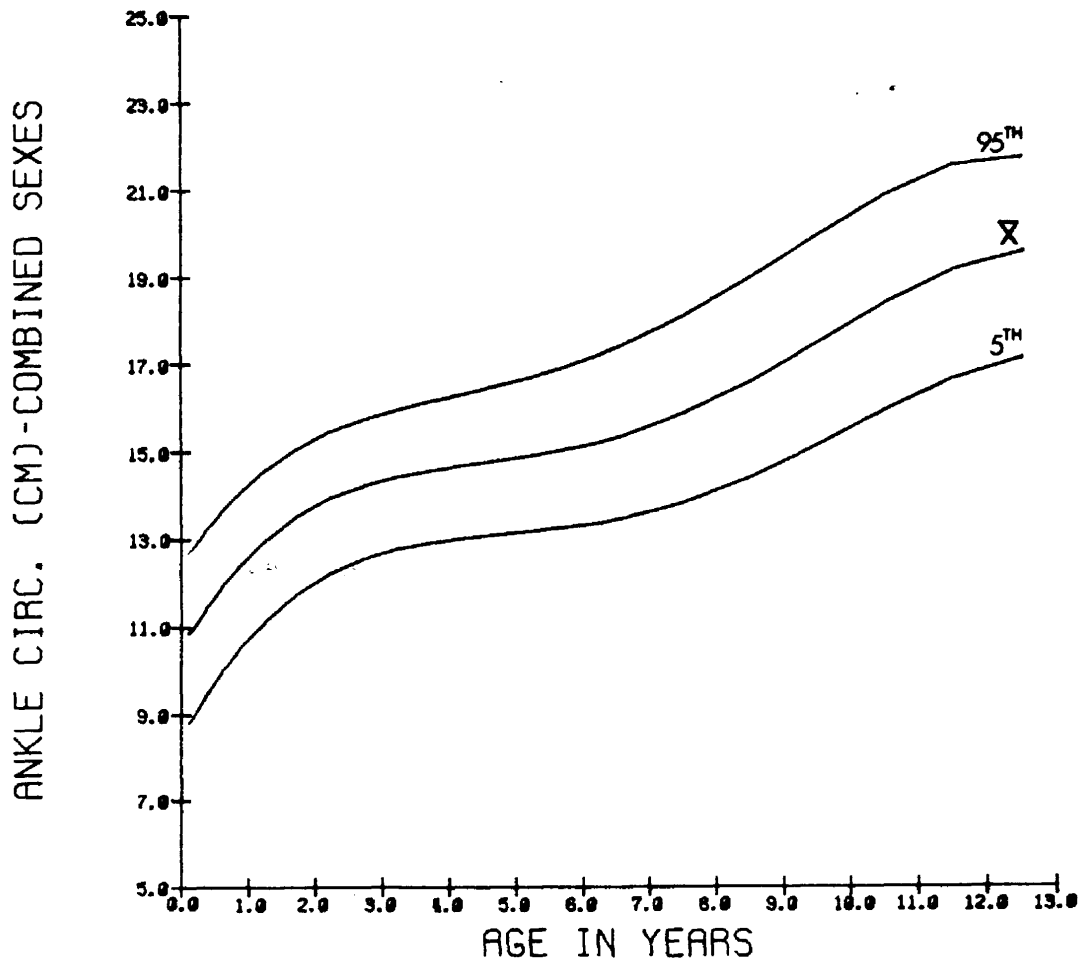



ANKLE CIRCUMFERENCE, IN CMS. - FEMALES

AGE(MO/YRS)	N	MEAN	S.D.	5%	50%	95%	
0- 3	62	9.8	1.2	7.8	9.8	11.8	
4- 6	54	11.5	1.1	9.7	11.4	13.2	
7- 9	28	12.0	1.1	9.7	12.0	13.7	
10- 12	1	23	12.7	0.9	10.8	12.7	14.0
13- 18	24	13.1	1.0	11.4	12.8	14.4	
19- 24	2	29	13.4	1.2	11.4	13.2	15.4
25- 30	29	13.9	1.0	12.3	13.6	15.6	
31- 36	3	55	13.7	1.0	11.8	13.6	15.5
37- 42	138	14.1	1.0	12.4	14.1	15.7	
43- 48	4	166	14.2	0.9	12.7	14.1	15.7
49- 54	184	14.4	0.9	12.9	14.3	15.9	
55- 60	5	170	14.7	1.1	12.9	14.5	16.5
61- 66	113	14.7	1.1	13.0	14.6	16.9	
67- 72	6	80	15.0	1.2	12.9	14.9	17.2
73- 78	90	15.3	1.2	13.6	15.3	17.3	
79- 84	7	90	15.4	0.9	13.6	15.5	16.8
85- 96	8	146	16.1	1.2	14.1	15.9	18.3
97-108	9	141	16.7	1.4	14.5	16.4	19.2
109-120	10	150	17.2	1.4	14.8	17.0	19.7
121-132	11	102	18.2	1.6	15.7	17.9	20.9
133-144	12	63	18.8	1.6	15.8	18.6	21.1
145-156	13	32	20.1	1.4	17.7	20.1	22.5

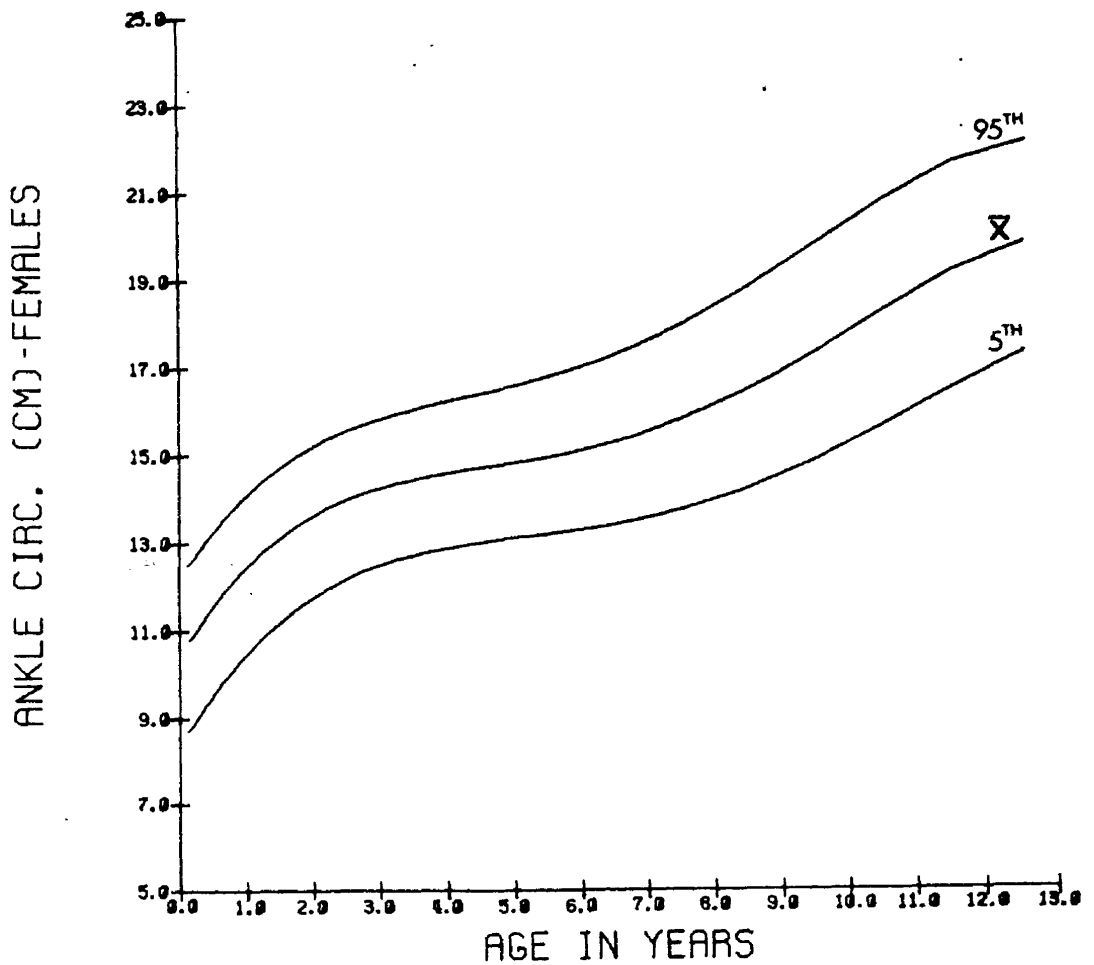

ANKLE CIRCUMFERENCE, IN CMS. - MALES

AGE (MO/YRS)	N	MEAN	S.D.	5%	50%	95%
0= 3	73	9.9	1.3	7.7	9.7	11.9
4= 6	42	12.2	1.0	9.9	12.3	13.6
7= 9	24	12.7	1.0	10.6	12.6	14.0
10= 12 1	21	12.9	0.7	11.2	12.8	14.0
13= 18	29	13.2	0.7	11.7	13.0	14.3
19= 24 2	41	14.2	0.9	12.5	14.0	15.0
25= 30	34	14.1	0.9	12.3	14.1	15.5
31= 36 3	48	14.1	1.1	12.2	14.1	15.9
37= 42	129	14.2	0.9	12.6	14.2	15.8
43= 48 4	121	14.3	1.0	12.8	14.2	15.8
49= 54	171	14.6	0.9	12.8	14.5	16.2
55= 60 5	150	14.8	1.1	13.0	14.6	16.6
61= 66	125	15.1	1.0	13.2	15.0	16.7
67= 72 6	90	15.3	1.1	13.2	15.3	16.9
73= 78	75	15.4	1.0	13.8	15.0	17.3
79= 84 7	72	15.9	1.2	13.8	16.0	17.6
85= 96 8	132	16.2	1.4	14.2	16.1	19.1
97=108 9	128	16.8	1.3	15.0	16.5	19.2
109=120 10	105	17.5	1.4	15.0	17.4	19.8
121=132 11	97	18.5	1.5	16.1	18.4	21.3
133=144 12	52	19.1	1.3	16.4	19.1	20.7
145=156 13	20	19.5	1.4	16.3	19.0	22.3

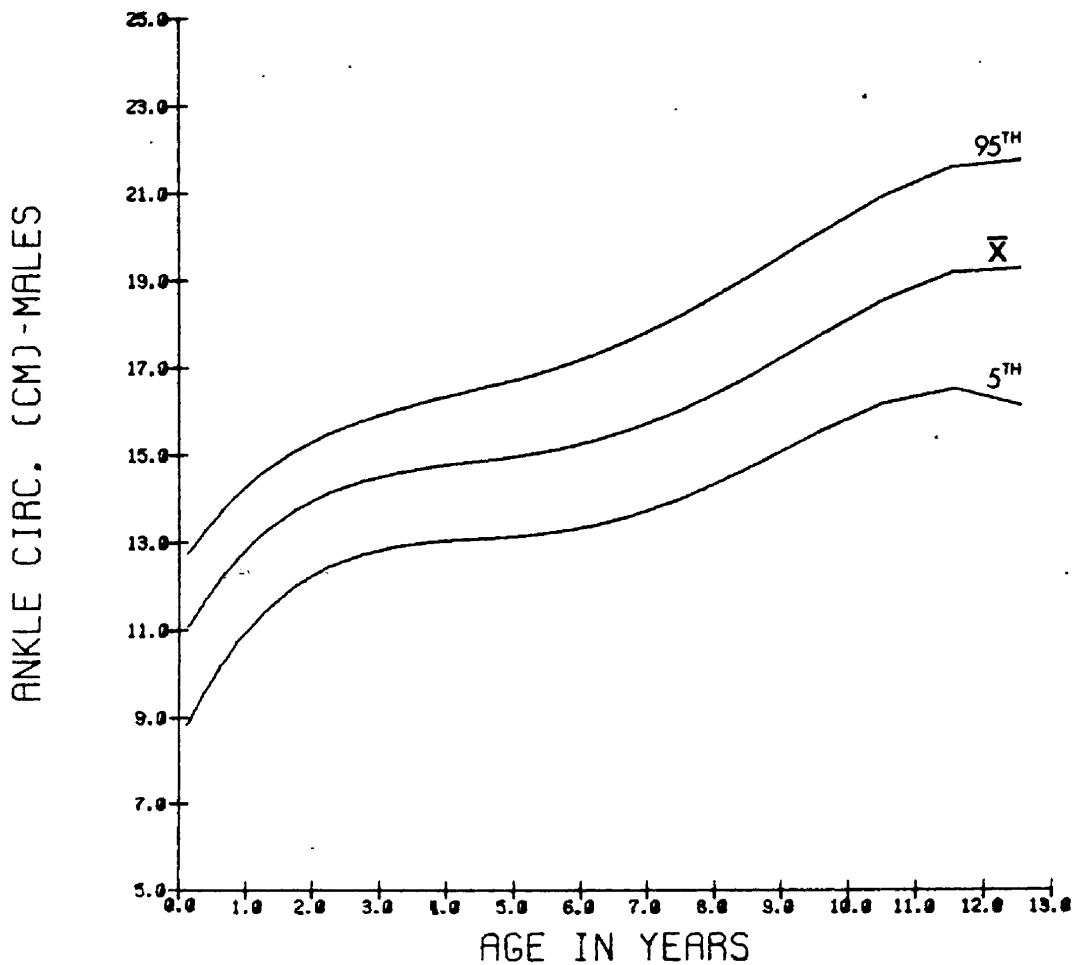

STANDING CENTER OF GRAVITY  
% STATURE

Device: A plexiglas cradle supported by a frame balanced on three precisely calibrated load cells. Signals from the load cells are recorded automatically by the computer upon depression of a command key on the keyboard. Each load cell is sampled 500 times and the average value used to compute the location of the center of gravity.

Description: INFANT: The infant lies supine with the apex placed against a reference plane. The arms are kept at the sides and the legs maintained as straight as possible. The distance of the center of gravity ( $D_1$ ) from the apex is computed from the relative weight carried by the load cells at each end. This distance is subtracted from the crown-sole measurement and expressed as a percentage of crown-sole from the soles of the feet [ $((\text{crown sole} - D_1) / \text{crown sole}) \times 100$ ].

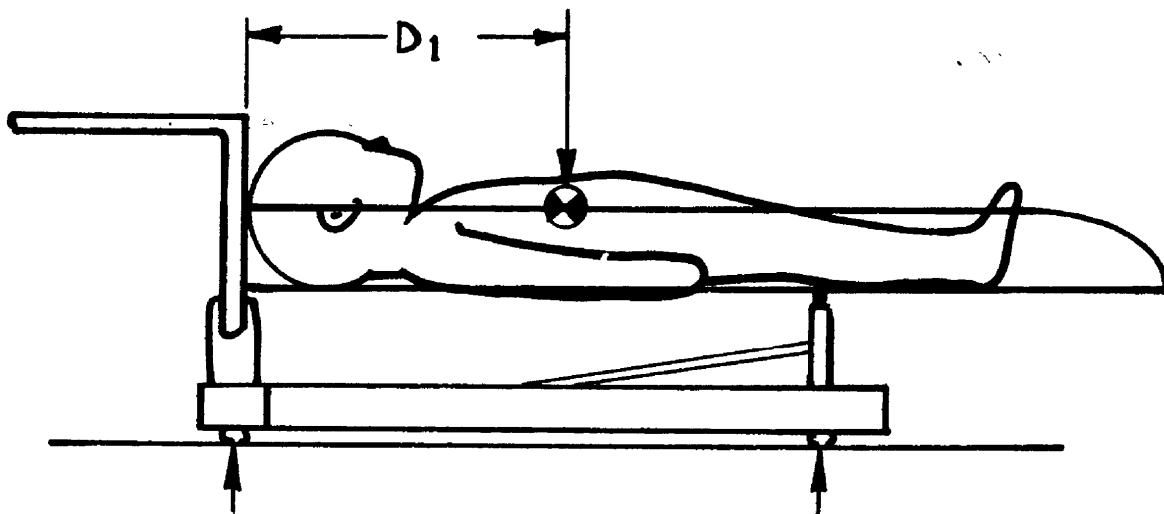
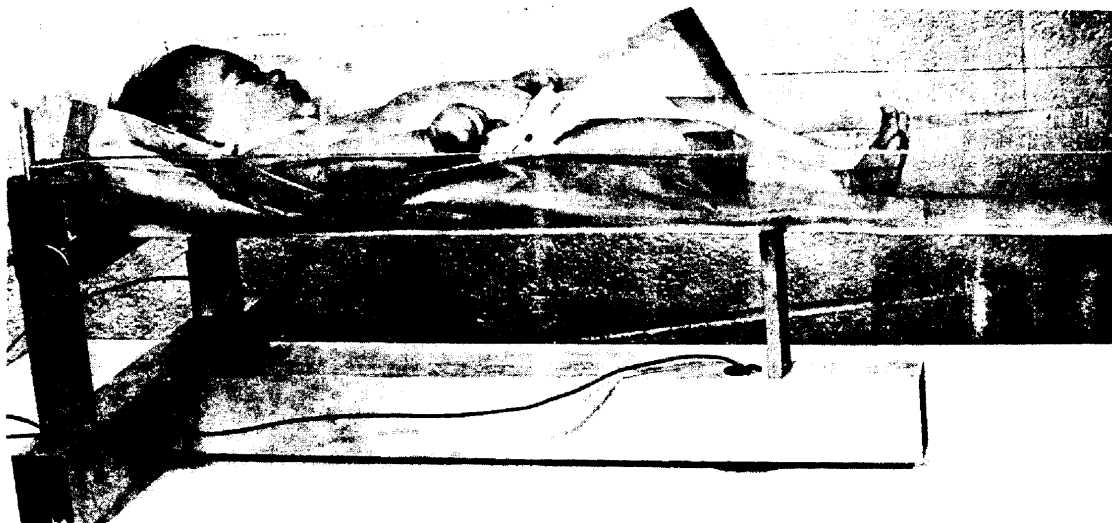

STANDING CENTER OF GRAVITY  
% STATURE

Device: A horizontal platform supported by a frame balanced on three precisely calibrated load cells. Signals from the load cells are recorded automatically by the computer upon depression of a command key on the keyboard. Each load cell is sampled 500 times and the average value used to compute the location of the center of gravity.

Description: CHILD: The child lies supine with the feet placed squarely against a reference plane. The arms are placed at the sides with the legs straight. The distance of the center of gravity ( $D_3$ ) from the soles of the feet is computed and expressed as a percentage of the child's stature  $[(D_3 / \text{stature}) \times 100]$ .

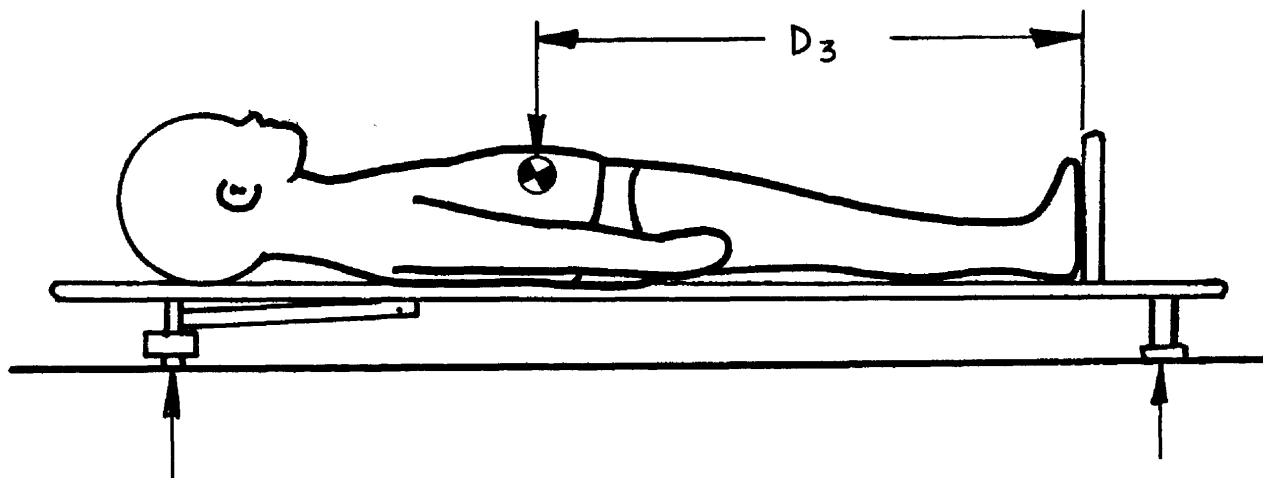

STANDING CG = % STATURE, = COMBINED SEXES

AGE (MO/YRS)	N	MEAN	S.D.	5%	50%	95%
0= 3	52	58.9	2.1	55.5	58.6	62.4
4= 6	34	58.5	2.4	53.9	58.9	62.0
7= 9	12	58.0	2.4	54.3	58.4	61.4
10= 12 1	18	58.3	2.1	53.3	58.2	62.3
13= 18	9	58.7	2.0	56.5	57.9	62.9
19= 24 2	10	57.5	1.0	56.2	57.1	59.2
25= 30	19	59.8	2.4	55.7	59.9	65.0
31= 36 3	14	59.2	2.2	56.2	58.9	64.5
37= 42	28	59.1	2.0	54.9	59.0	62.5
43= 48 4	34	59.1	1.9	54.9	59.2	62.3
49= 54	38	59.2	2.0	55.4	59.2	61.4
55= 60 5	28	59.1	1.8	55.2	59.0	62.1
61= 66	53	59.2	1.4	56.1	59.1	61.5
67= 72 6	55	59.2	1.4	56.8	59.3	61.1
73= 78	65	58.8	1.2	56.9	58.8	60.7
79= 84 7	56	58.6	1.2	56.4	58.5	60.6
85= 96 8	92	58.3	1.5	55.8	58.3	60.6
97=108 9	85	58.0	1.3	55.9	57.9	60.0
109=120 10	104	57.7	1.0	55.9	57.6	59.6
121=132 11	97	57.5	0.9	56.1	57.4	59.2
133=144 12	59	57.6	1.0	55.9	57.3	59.5
145=156 13	27	57.7	1.4	55.7	57.2	59.5

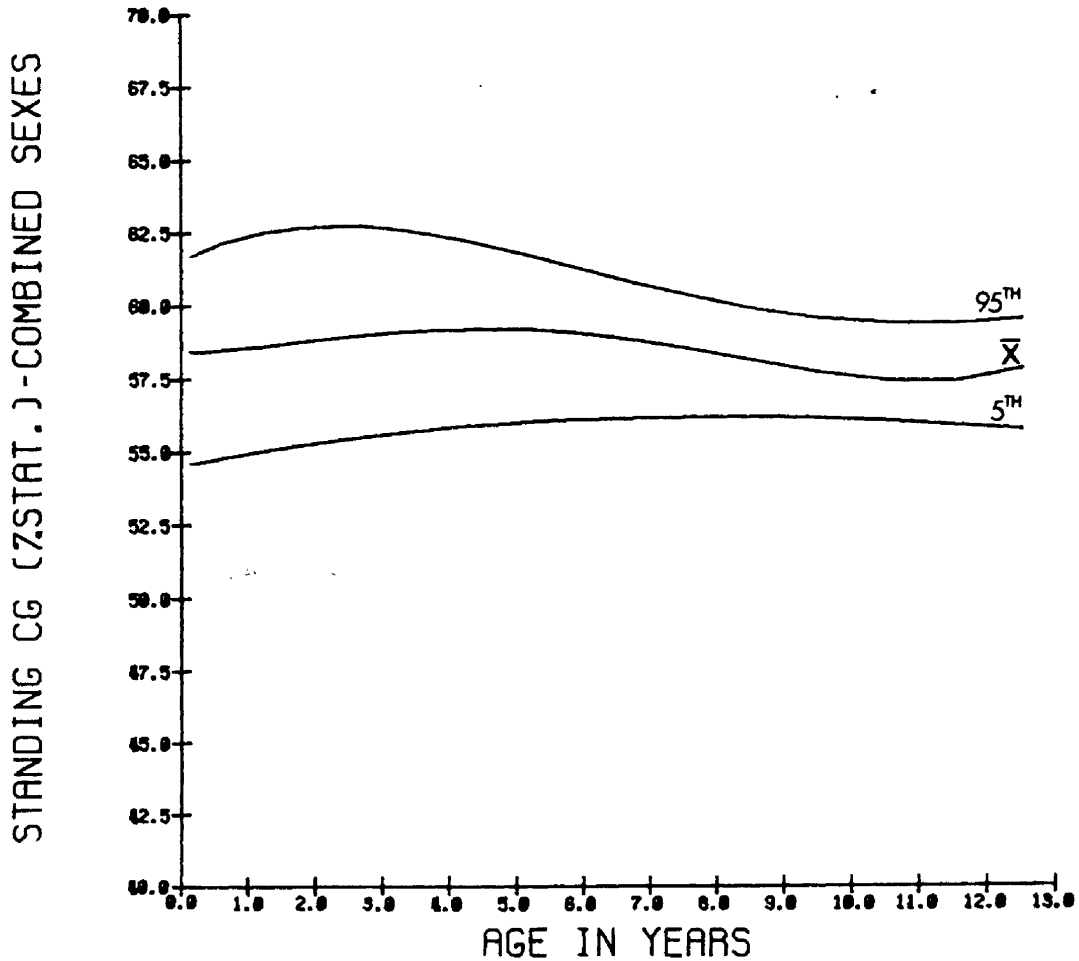

STANDING CG = % STATURE, = FEMALES

AGE(MO/YRS)	N	MEAN	S.D.	5%	50%	95%
0= 3	22	59.4	1.9	56.0	59.3	62.3
4= 6	21	58.1	2.5	51.4	57.0	61.2
7= 9	6	58.3	2.2	55.1	58.5	61.4
10= 12	1	58.1	1.8	55.2	57.7	60.5
13= 18	3	57.4	0.8	56.5	57.1	58.0
19= 24	2	57.5	1.0	56.4	57.0	59.2
25= 30	10	60.5	2.1	57.5	60.2	65.0
31= 36	3	59.3	2.5	56.2	58.9	64.5
37= 42	10	58.9	2.0	56.7	57.9	63.3
43= 48	4	58.8	2.0	54.3	58.9	61.4
49= 54	19	59.2	2.1	55.5	59.2	64.4
55= 60	5	59.3	2.0	54.1	59.0	62.6
61= 66	31	59.2	1.7	55.0	59.0	61.8
67= 72	6	59.3	1.5	56.8	59.4	60.9
73= 78	39	58.8	1.2	56.8	58.7	60.7
79= 84	7	58.6	1.1	56.5	58.3	60.7
85= 96	8	58.0	1.7	54.6	57.7	60.7
97=108	9	58.0	1.4	55.8	57.9	60.2
109=120	10	57.5	0.9	55.7	57.5	59.0
121=132	11	57.4	0.7	56.0	57.4	58.7
133=144	12	57.4	1.1	55.9	57.1	59.2
145=156	13	57.4	1.3	55.7	57.0	59.7

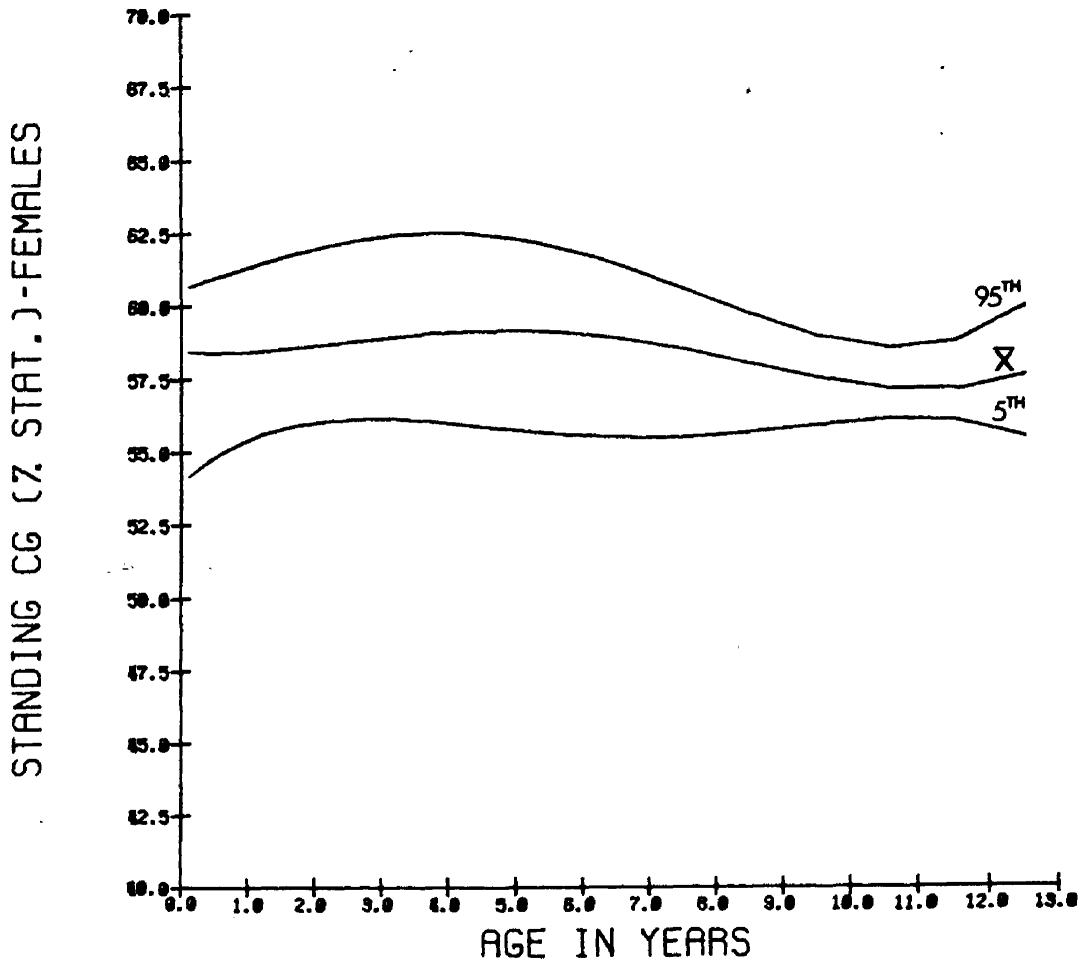

STANDING CG = % STATURE,      • MALES

AGE (MO/YRS)	N	MEAN	S.D.	5%	50%	95%
0= 3	30	58.5	2.1	54.1	58.5	62.2
4= 6	13	59.1	2.3	55.2	59.0	62.3
7= 9	6	57.7	2.7	54.3	56.6	61.4
10= 12 1	12	58.5	2.4	53.3	58.2	62.3
13= 18	6	59.4	2.1	57.0	58.7	62.9
19= 24 2	5	57.5	1.1	56.2	57.2	59.2
25= 30	9	59.1	2.5	55.7	58.8	63.2
31= 36 3	4	58.9	1.0	57.7	58.6	60.2
37= 42	18	59.2	2.0	54.1	59.2	62.7
43= 48 4	13	59.7	1.7	57.0	59.4	62.5
49= 54	19	59.2	2.0	55.4	59.2	63.7
55= 60 5	10	58.9	1.7	57.1	58.3	62.3
61= 66	22	59.1	1.1	56.6	59.1	61.0
67= 72 6	30	59.1	1.3	56.5	59.1	61.1
73= 78	26	58.9	1.2	56.7	58.8	60.7
79= 84 7	27	58.7	1.3	56.3	58.6	60.3
85= 96 8	47	58.6	1.1	56.7	58.5	60.5
97=108 9	42	57.9	1.1	56.0	57.9	59.7
109=120 10	45	58.0	1.1	56.0	57.7	60.3
121=132 11	45	57.7	1.0	56.1	57.3	59.7
133=144 12	29	57.8	1.0	55.8	57.6	59.4
145=156 13	14	58.0	1.5	55.9	57.5	62.3

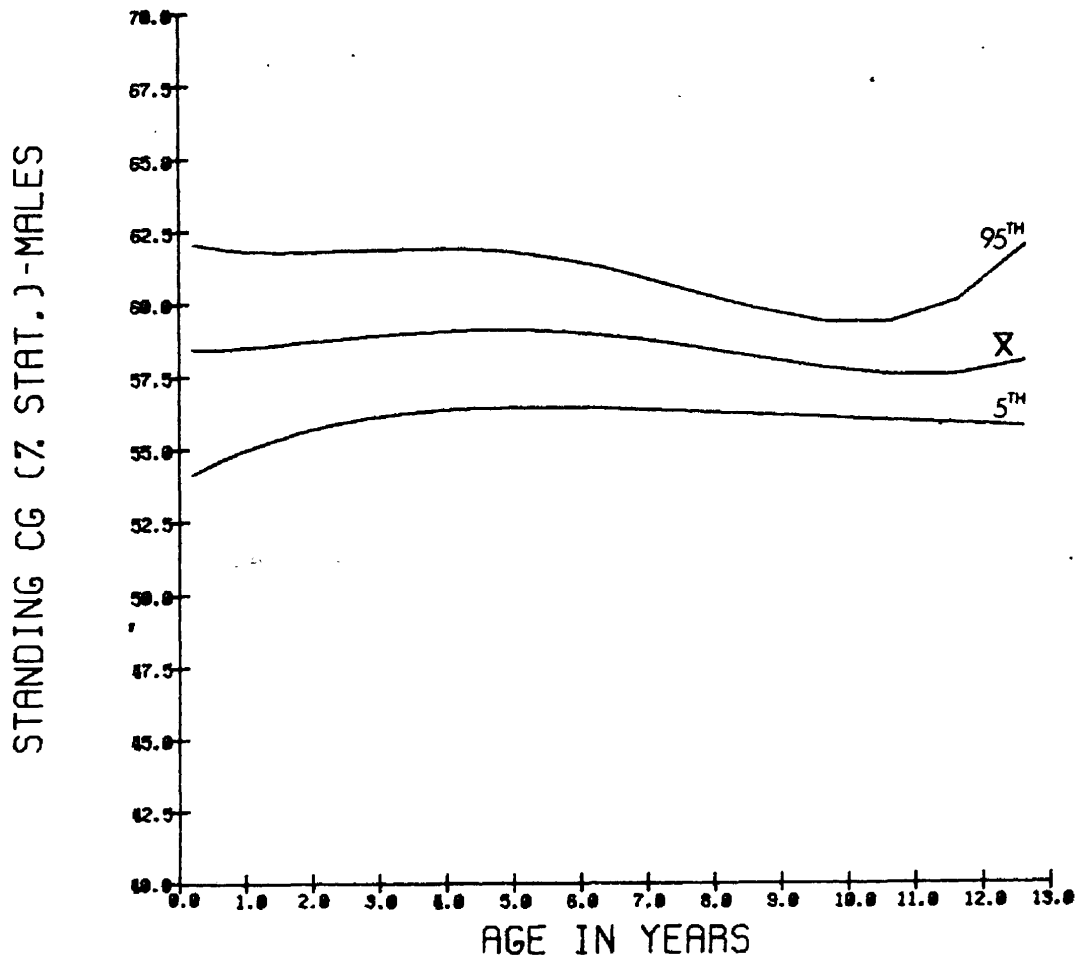

SEATED CENTER OF GRAVITY  
% SITTING HEIGHT

Device: A plexiglas cradle with leg support adjusted for infant. The cradle is supported by a frame balanced on three precisely calibrated load cells. Signals from the load cells are recorded automatically by the computer upon depression of a command key on the keyboard. Each load cell is sampled 500 times and the average values used to compute the location of the center of gravity.

Description: INFANT: The infant lies supine with the legs placed over the adjustable support so that the knees form a 90° angle and the buttock is firmly against a reference plane. The arms are kept at the sides as well as possible. The distance of the center of gravity from the buttock reference plane ( $D_2$ ) is computed and expressed as a percentage of the crown-rump measurement [ $(D_2 / \text{crown rump}) \times 100$ ].

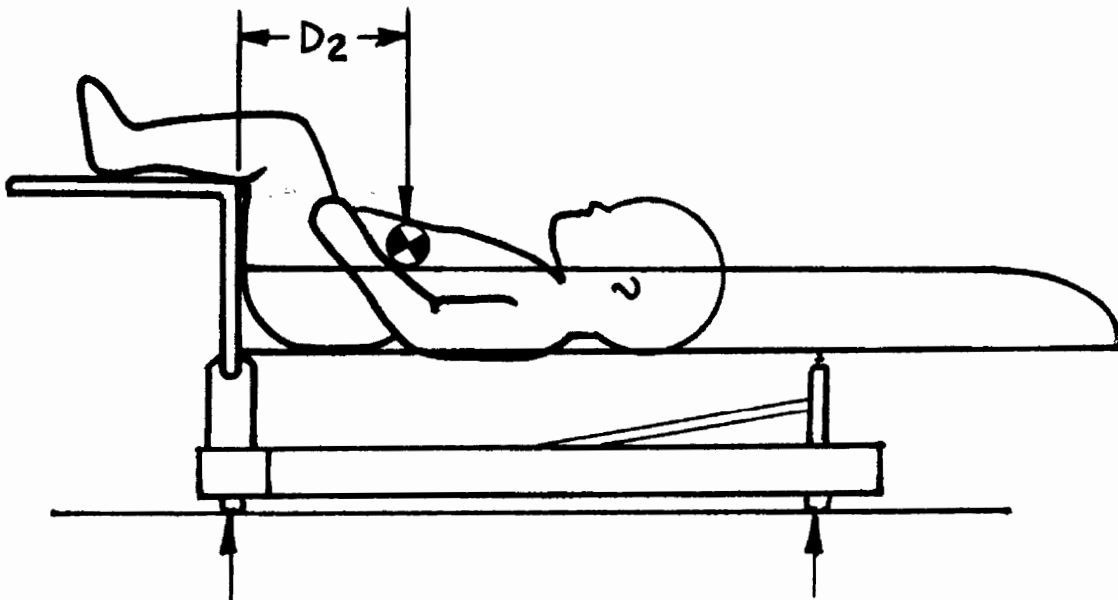
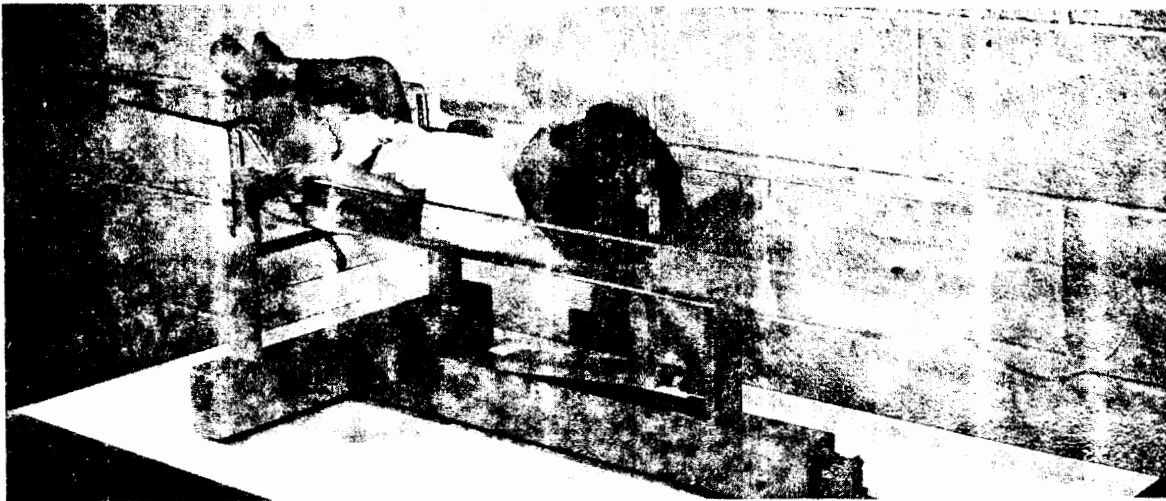



SEATED CENTER OF GRAVITY  
% SITTING HEIGHT

Device: Horizontal platform with adjustable leg support attached. The platform is supported by a frame balanced on three precisely calibrated load cells. Signals from the load cells are recorded automatically by the computer upon depression of a command key on the keyboard. Each load cell is sampled 500 times and the average values used to compute the location of the center of gravity.

Description: CHILD: The child lies supine with the legs placed over the adjustable support so that the knees form a 90° angle and the buttock is firmly against a reference plane. The arms are placed at the sides ( $D_4$ ). The distance of the center of gravity from the buttock reference plane is computed and expressed as a percentage of the sitting height [ $(D_4 / \text{sitting ht.}) \times 100$ ].

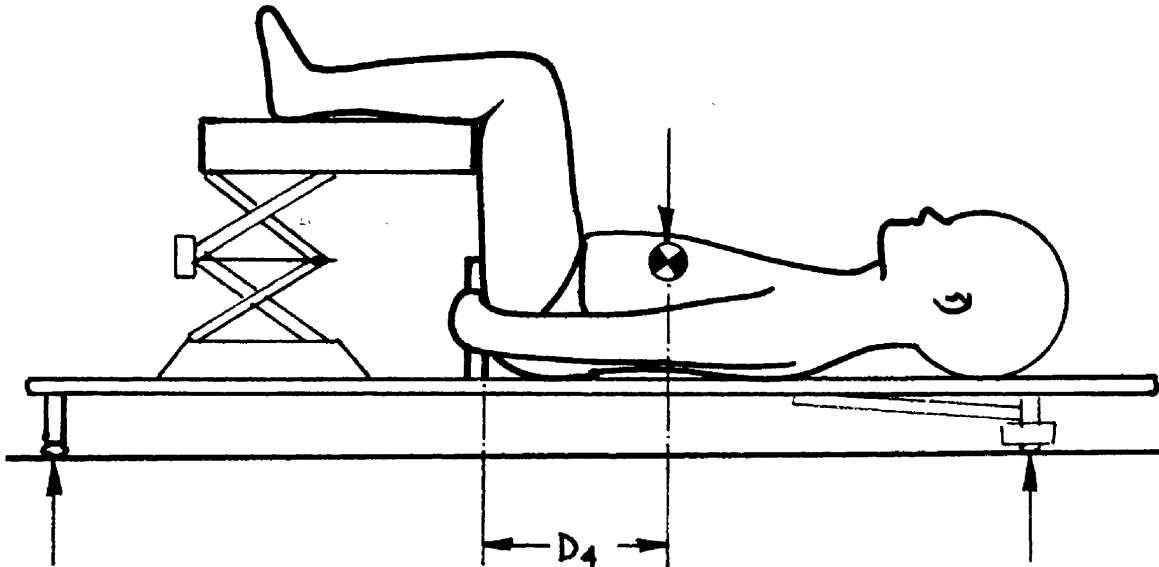
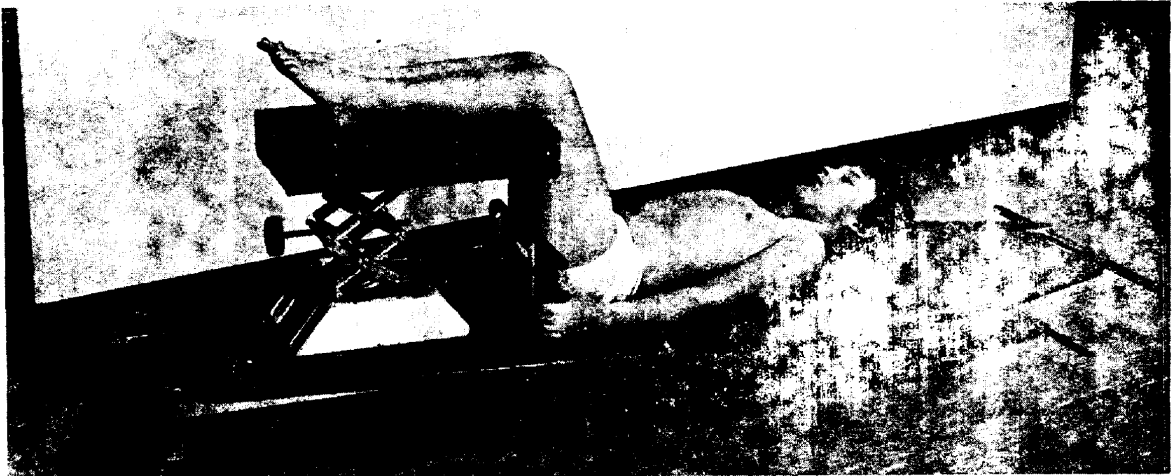

SEATED CG = % SITTING HEIGHT, = COMBINED SEXES

AGE (MO/YRS)	N	MEAN	S.D.	5%	50%	95%	
0- 3	47	48.9	4.1	42.7	48.6	56.7	
4- 6	27	46.9	3.1	42.0	45.9	52.5	
7- 9	8	46.6	2.7	41.5	46.8	50.7	
10- 12	1	8	45.2	2.4	42.0	44.8	49.9
13- 18	8	42.9	3.5	38.0	41.9	49.3	
19- 24	2	9	40.4	2.6	37.2	39.7	45.4
25- 30	16	40.9	3.0	35.7	39.8	47.3	
31- 36	3	14	38.7	1.9	35.9	38.1	41.9
37- 42	29	38.7	2.2	35.3	38.2	41.7	
43- 48	4	32	37.6	3.0	32.8	37.2	42.7
49- 54	40	36.4	2.2	32.6	36.5	40.2	
55- 60	5	28	35.8	2.6	30.6	35.9	40.1
61- 66	53	36.1	4.2	32.1	35.7	39.5	
67- 72	6	52	34.5	2.1	30.9	34.4	38.0
73- 78	64	33.7	2.4	30.1	33.4	37.1	
79- 84	7	52	33.2	1.9	29.7	33.1	37.0
85- 96	8	91	32.2	2.3	28.8	31.8	36.3
97-108	9	84	31.4	1.8	28.0	31.3	34.1
109-120	10	102	30.6	2.0	27.1	30.9	34.0
121-132	11	94	29.7	1.6	26.9	29.6	32.8
133-144	12	57	29.7	1.8	27.2	29.3	32.9
145-156	13	27	29.5	1.4	26.5	29.3	31.8

SEATED CG (% SIT. HT.) - COMBINED SEXES

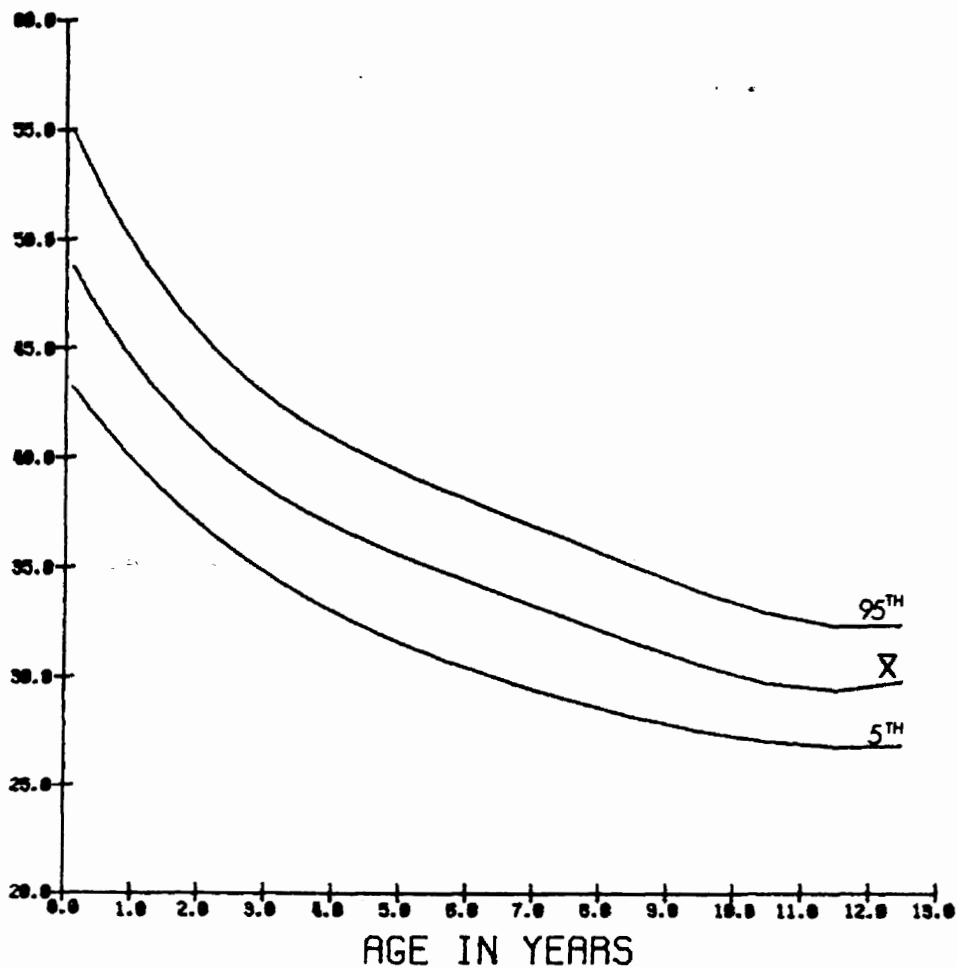

SEATED CG = % SITTING HEIGHT,      - FEMALES

AGE(MO/YRS)	N	MEAN	S.D.	5%	50%	95%	
0= 3	20	50.2	3.3	45.2	49.2	60.0	
4= 6	16	47.1	2.8	43.1	46.7	53.0	
7= 9	3	48.2	2.5	45.6	46.9	50.7	
10= 12	1	3	44.6	2.3	42.0	43.8	46.3
13= 18	3	42.2	6.1	38.0	38.7	49.3	
19= 24	2	5	41.3	2.4	39.3	40.2	45.4
25= 30	10	41.9	2.7	38.3	40.5	47.3	
31= 36	3	10	39.1	1.9	35.9	38.6	41.9
37= 42	10	39.5	2.8	35.9	39.2	45.3	
43= 48	4	21	37.9	3.3	33.5	36.3	43.2
49= 54	20	36.7	2.6	32.7	36.8	41.7	
55= 60	5	18	35.3	2.6	30.3	35.5	40.3
61= 66	31	36.8	5.0	32.6	36.3	39.8	
67= 72	6	24	34.0	2.3	29.3	34.3	37.8
73= 78	40	33.6	2.3	28.3	33.5	37.0	
79= 84	7	25	33.3	1.8	29.6	33.0	36.6
85= 96	8	43	32.2	2.4	28.7	31.8	36.4
97=108	9	42	30.7	1.6	27.6	30.8	32.6
109=120	10	58	30.2	2.0	26.5	30.4	33.9
121=132	11	50	29.5	1.6	26.9	29.5	32.4
133=144	12	29	29.4	1.4	27.3	29.1	32.0
145=156	13	13	29.2	1.3	27.4	29.0	31.6

SEATED CG (% SIT. HT.)-FEMALES

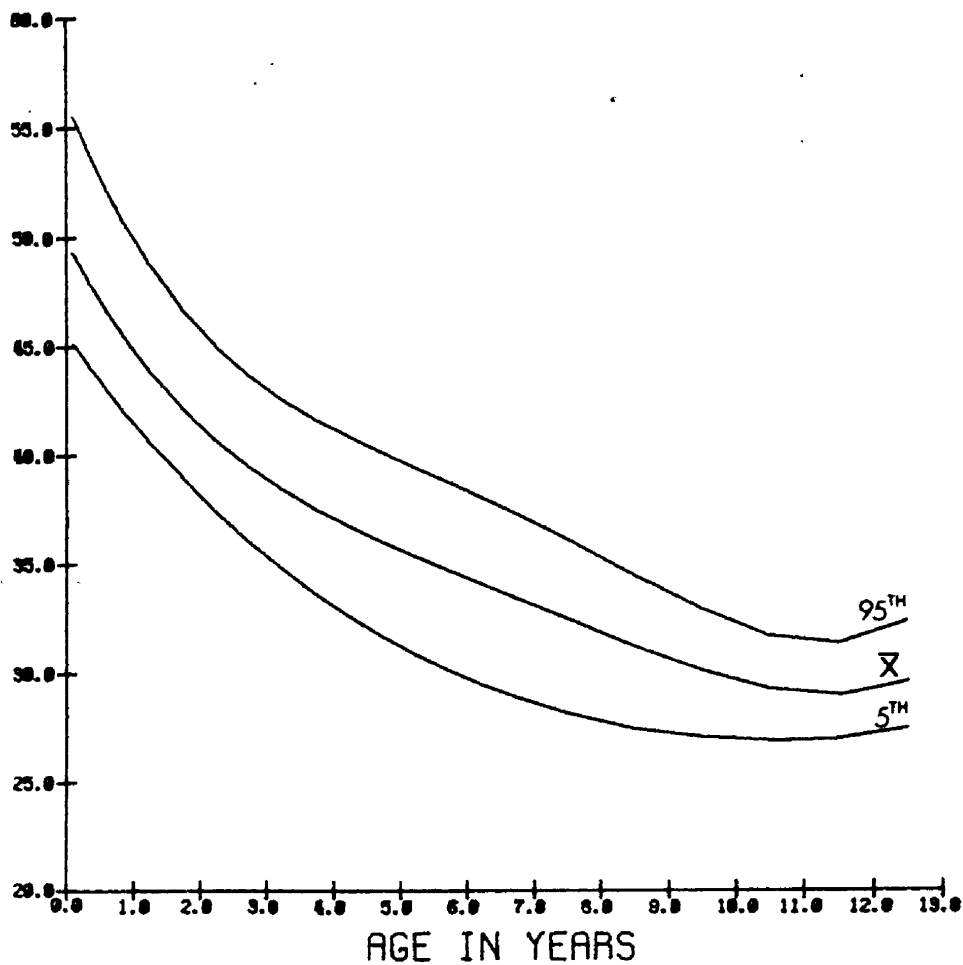

SEATED CG = % SITTING HEIGHT, = MALES

AGE(MO/YRS)	N	MEAN	S.D.	5%	50%	95%
0= 3	27	48.0	4.4	41.3	46.8	55.9
4= 6	11	46.6	3.7	41.5	44.9	54.0
7= 9	5	45.6	2.6	41.5	45.7	48.1
10= 12	1	45.6	2.7	42.7	44.8	49.9
13= 18	5	43.4	1.6	41.7	42.6	45.4
19= 24	2	39.3	2.6	37.2	37.5	43.0
25= 30	6	39.2	3.0	35.7	37.9	43.4
31= 36	3	37.6	1.2	36.3	37.0	39.1
37= 42	19	38.2	1.7	35.2	37.8	41.3
43= 48	4	37.2	2.2	31.9	37.2	41.0
49= 54	20	36.1	1.7	32.6	36.3	39.1
55= 60	5	36.6	2.6	31.1	36.1	40.2
61= 66	22	34.9	2.2	30.4	34.9	39.2
67= 72	6	35.0	1.9	31.4	34.5	37.9
73= 78	24	33.8	2.7	30.1	33.4	38.0
79= 84	7	33.1	2.1	28.7	33.2	36.6
85= 96	8	32.3	2.2	28.9	31.8	35.9
97=108	9	32.1	1.8	28.2	32.0	34.5
109=120	10	31.1	1.9	27.6	31.0	34.1
121=132	11	30.0	1.6	26.2	29.7	32.9
133=144	12	30.1	2.1	27.1	30.0	33.6
145=156	14	29.7	1.5	26.1	29.8	32.3

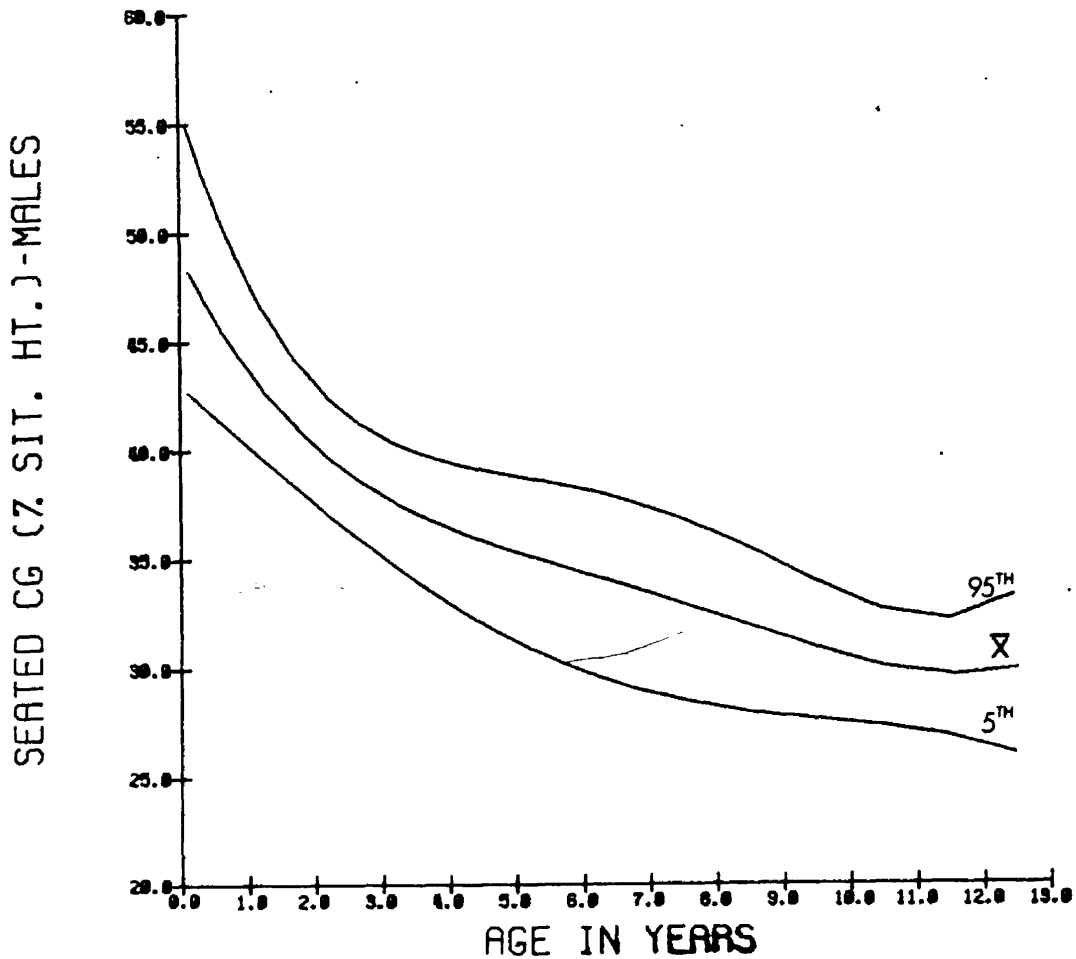

#### IV. RELATED TECHNICAL REPORTS AND PUBLICATIONS

The following publications, reports, technical presentations, and 16mm movie film have resulted to date from this study.

##### Publications

1975 Snyder, R. G., C. Owings, M. Spencer, L. W. Schneider, ANTHROPOMETRY OF U.S. INFANTS AND CHILDREN. Society of Automotive Engineers, Report No. 750423, May.

1974 Snyder, R. G., C. L. Owings, M. L. Spencer, and L. W. Schneider, NEW TECHNIQUES FOR INFANT AND CHILD ANTHROPOMETRY: MINI-COMPUTER CONTROLLED ANTHROPOMETRY AND CENTER OF GRAVITY MEASUREMENTS (LA ANTROPOMETRIA Y LAS MEDIDAS DEL CENTRO DE GRAVEDAD DE LOS NIÑOS ESTADOUNIDENSES UTILIZANDO EL AVANZADO SISTEMA AUTOMATIZADO DE MICHIGAN DE LA MINI-CALCULADORA ELECTRONICA) Proceedings, American Anthropological Association, p. 133, Mexico City (November)

Owings, C.L., L. W. Schneider, R. G. Snyder, and M. L. Spencer, A PORTABLE SYSTEM FOR INFANT AND CHILD CENTER OF GRAVITY MEASUREMENT. Proceedings, Conference on Engineering, Medicine and Biology, Pg. 375, (October).

Owings, C. L., L. W. Schneider, R. G. Snyder, and M. L. Spencer, COMPUTER CONTROLLED ANTHROPOMETRY: A PORTABLE SYSTEM FOR USE WITH INFANTS AND CHILDREN, Proceedings, Conference on Engineering, Medicine and Biology, p. 385, (October).

Snyder, R. G., M. L. Spencer, C. L. Owings, and L. W. Schneider, INFANTS AND CHILDREN ANTHROPOMETRY (L'ANTHROPOMETRIE DES ENFANTS ET DES NOURRISSIONS) Proceedings, International Research Committee on Biokinetics of Impacts, Biomechanics of Trauma in Children. Pg. 139-149. Lyon, France, (September).

Owings, C. L., R. G. Snyder, M. L. Spencer, and L. W. Schneider, NEW TECHNIQUES FOR INFANT AND CHILD ANTHROPOMETRY: MINI-COMPUTER CONTROLLED ANTHROPOMETRY AND CENTER OF GRAVITY MEASUREMENTS, Proceedings, American Journal of Physical Anthropology, (February).

1972 Snyder, R. G., M. Spencer, C. Owings, and P. Van Eck, SOURCE DATA OF INFANT AND CHILD MEASUREMENT, Interim Data, 1972. Prepared for U.S. Food and Drug Administration, Children's Hazards Division, Bureau of Product Safety, Bethesda, Maryland, by the University of Michigan, Ann Arbor, December.

Snyder, R. G., M. Spencer, and C. Owings, SELECTED INFANT ANTHROPOMETRY CRIB SLAT STUDY, Food and Drug Administration, Bureau of Product Safety, Children's Hazards Division, Bethesda, Md., Report, 18 December.

Monthly Reports 1-36, April 1972, 31 March, 1975.

Oral Presentations

1975 NEW WAYS TO MEASURE CHILDREN: IMPLICATIONS FOR SAFETY. R. G. Snyder and C. L. Owings, University of Michigan Science Research Symposium. The Chrysler Center.

1975 SAE Engineering Congress, Detroit, 28 February. Snyder, R. G., C. Owings, M. Spencer, L. W. Schneider, and H. Reynolds, ANTHROPOMETRY OF U.S. CHILDREN.

1974 27th Annual Conference on Engineering in Medicine and Biology, Phila., 6 October, 1974. Owings, C. L., L. W. Schneider, R. G. Snyder, and M. L. Spencer. A PORTABLE SYSTEM FOR INFANT AND CHILD CENTER OF GRAVITY MEASUREMENT.

27th Annual Conference on Engineering in Medicine and Biology, Phila. 6 October 1974. COMPUTER CONTROLLED ANTHROPOMETRY: A PORTABLE SYSTEM FOR USE WITH INFANTS AND CHILDREN. Owings, C. L., L. W. Schneider, R. G. Snyder, and M. L. Spencer.

American Anthropological Association, Mexico City, Mexico, 20 November 1974. Snyder, R. G., C. L. Owings, M. L. Spencer and L. W. Schneider, NEW TECHNIQUES FOR INFANT AND CHILD ANTHROPOMETRY: MINI-COMPUTER CONTROLLED ANTHROPOMETRY AND CENTER OF GRAVITY MEASUREMENTS.

International Research Committee on Biokinetics of Impacts, Biomechanics of Trauma in Children, Lyon, France, 18 September 1974. Snyder, R. G., M. L. Spencer, C. L. Owings, and L. W. Schneider, INFANT AND CHILD ANTHROPOMETRY.

Annual Meeting, American Association of Physical Anthropologists, University of Massachusetts, Amherst, 11 April. Owings, C. L., R. G. Snyder, M. Spencer, and L. W. Schneider, NEW TECHNIQUES FOR INFANT AND CHILD ANTHROPOMETRY: MINI-COMPUTER CONTROLLED ANTHROPOMETRY AND CENTER OF GRAVITY MEASUREMENTS.

Films:

1975: NEW METHODS OF INFANT AND CHILD ANTHROPOMETRY FOR PRODUCT SAFETY. 18 minutes-color-sound-16mm. 31 March.

1973: CRIB-SLAT STUDY. TV release. 1 min. 30 sec.-color-sound-16mm-24 July.

Automatic Data Processing:

1975: Consumer Product Safety Commission Final Summary data in both printed tabular format and IBM compatible Magnetic Tape (9-track 1600 BPI with standard label) for 41 measurements of 4,027 U.S. Children from age 2 weeks to 12 years. (31 March)

## V. REFERENCES CITED

1. National Safety Council. Accident Facts Chicago, Illinois, 1974, p. 8.
2. Benjamin, B. "Actuarial Methods of Mortality Analysis: Adaptations to Changes in the Age and Cause Pattern: Proceedings, Royal Society (Biology) Vol. 159, December, 1963, pp. 48-49.
3. Keddy, J.A. "Accidents in Childhood: A Report on 17,141 Accidents" Le Journal de L'Association Medicale Canadienne Vol. 91 no. 13, September, 1964, pp. 675 - 680.
4. Neale, A.V. "The Changing Pattern of Death in Childhood: Then and Now" Med. Sci. Law Vol. 4 January, 1964, pp. 35-39.
5. Wegman, M.E. "Annual Summary of Vital Statistics for 1973" Pediatrics Vol. 54, no. 6, December, 1974, pp. 677-781.
6. Hunt, E.P., and A.D. Chenoweth. "Recent Trends in Infant Mortality in the United States" American Journal of Public Health Vol. 51, no. 2, 1961, pp. 190-207
7. U.S. Department of Health, Education, and Welfare. Injury Control Program. 1968 "Estimated of Injuries from Consumer Products," Submitted at NCPS Hearing of 21 October, and cited, Final Report of the National Commission on Product Safety. June, 1970, p. 30.
8. Personal Communication. Consumer Product Safety Commission. February, 1975.
9. Final Report of the National Commission on Product Safety. U.S. Government Printing Office, Washington, D.C. June, 1970.
10. Consumer Product Safety Commission National Electronic Injury Surveillance System (NEISS), 1973.
11. Pascarella, E.A., Foley, J.P., Levine, D.N., Stewart, J.R. Characteristics of Youthful Bicycle Riders in an Urban Community and Events Accruing to Operation of Their Vehicles. University of North Carolina Highway Safety Research Center. June, 1971.
12. Blake, R., Jr. Pedestrian and Bicycle Accidents. State of Idaho Department of Highways Planning of Traffic Division, September, 1973.
13. Brezina, E., and Kramer, M. An Investigation of Rider, Bicycle and Environmental Variables in Urban Bicycle Collisions. Ontario Department of Transportation, Technical Bulletin SE-70-01, October, 1970.
14. National Transportation Safety Board. Special Study: Bicycle Use as a Highway Safety Problem. Report No. NTSB-HSS-72-1, 5 April, 1972.
15. Rice, R.S. and R.D. Roland, Jr. An Evaluation of the Performance and Handling Qualities of Bicycles. Cornell Aeronautical Laboratory, Inc. Technical Report No. VJ-2888-K, April, 1970.

16. Vilardo, F.J. and J.H. Anderson Bicycle Accidents to School Aged Children. National Safety Council, Report No. 169, September, 1969.
17. Vilardo, F.J., Nicolo, M.J., Heldreth, H.E. An Investigation Into Bicycle Usage. National Safety Council, Report No. 268, September, 1968.
18. Waller, J.A. Bicycle Ownership, Use and Injury Patterns Among Elementary School Children in Chitenden County, Vermont. August, 1970.
19. Waller, P.A. and D.W. Reinfurt Bicycles: An Analysis of Accidents in North Carolina. University of North Carolina Highway Safety Research Center. Contract No. CPF 69-30 (Sponsor: Food and Drug Administration, Rockville, Md.), 1969.
20. Federal Hazardous Substances Act (Amendments) P.L. 89-756 and P.L. 91-113). (U.S. Department of Health, Education and Welfare, Public Health Services, Food and Drug Administration, Rockville, Maryland), 1971, p.6.
21. National Safety Council. Accident Facts. Chicago, Illinois, 1970.
22. Keddy, J.A. "Accidents in Childhood: A Report on 17,141 Accidents" Le Journal de L'Association Medicale Canadiene Vol. 91, no. 13, September, 1964, pp. 675-680.
23. Southard, S.C. Personal Communication, 1969.
24. Greendyke, R.M. "Accidental Strangulations in Infancy", Pediatrics, Vol.36, August, 1965, pp. 275-276.
25. L'Hirondel, J. "On the Safety of the Infant in Crib and High Chairs", Pediatrics, Vol. 15, 1960, p. 598.
26. L'Hirondel, J. "The Safety of the Infant in Its Crib and in High Chairs: Strangulation by Restraining Apparatus and in Falls", Revue d'Hygiene et Medecine Scolaires et Universitaires, Vol. 9, 1961, p. 653.
27. Zachaw-Christiansen, B. and J. Jensen. "Death by Suffocation in Children During the First Three Years of Life: With Special Reference to Suffocation in Children's Harnesses:", Ugeskrift for Laeger (Kobenhavn), Vol. 123, 1961, p. 1049.
28. Haddon, W., Jr. "Approaching the Epidemiology of Head Injuries", Journal of Trauma, Vol. 10, no. 8, August, 1970, pp. 712-714.
29. The National Commission on Product Safety. Product and Injury Identification. Supplemental Studies, Vol. 1. A Staff report, U.S. Government Printing Office, Washington, D.C., June, 1970.
30. Snyder, R.G., M.L. Spencer, and C.L. Owings Selected Infant Anthropometry: Crib Slat Sub Study, February, (unpublished report) 1973.
31. Federal Register "Requirements for Full-Size Baby Cribs" Part 1508 of The Hazards Substances Act published November 21, 1973 - effective February, 1974. Vol. 38, 1973 pp. 32129-32133.



32. Snyder, R.G., M. Spencer, C. Owings, and P. Van Eck. Source Data of Infant and Child Measurements Interim Data, 1972. Prepared for Children's Hazards Division, Bureau of Product Safety, Food and Drug Administration, Bethesda. The University of Michigan, Ann Arbor. January, 1973, (Reprinted January, 1975).
33. Marshall, W.A. and C.O. Carter "Child on Mid-Parent Regression for Full Adult Stature" Proceedings, Society for the Study of Human Biology London. April, 1975
34. Young, J.W. Selected Facial Measurements of Children for Oxygen-Mask Design. Office of Aviation Medicine, Federal Aviation Agency, Oklahoma City, Oklahoma. Report No. AM66-9. April, 1966.
35. Stoudt, H.W. Anthropometry for Child Restraints. U.S. Department of Transportation, National Highway Traffic Safety Administration, Washington, D.C. Report No. DOT-HS-800 535. July, 1971.
36. Young, J.W., J.T. McConville, H.M. Reynolds, and R.G. Snyder. Evaluation of Masterbody Forms for 3-year and 6-year old Child Dummies. Memorandum Report to National Highway Traffic Safety Administration; Civil Aeromedical Institute, Federal Aviation Administration, Oklahoma City. 28 March, 1975.
37. Krogman, W.M. "Growth of Man" Tabulae Biologicae. W. Junk Publishing Co. The Hague, Holland, Vol. xx, 1941
38. Garrett, J.W. and K.W. Kennedy. A Collation of Anthropometry Vols. 1 and 2. Aerospace Medical Research Laboratory, Air Force Systems Command, Wright-Patterson Air Force Base, Ohio. March, 1971.
39. Collins, S.D. and T. Clark. "Physical Measurements of Boys and Girls of Native White Race Stock (Third Generation Native Born) in the United States" Public Health Reports, Vol. 44, 1929, pp. 1059-1083.
40. Gray, H., and J.G. Ayres. "Growth of Private School Children (with Averages and Variabilities Based on 3,110 Measurements on Boys and 1,470 on Girls from the Ages of 1 to 19 years)" Behavior Research Fund Monographs, 1931.
41. Wise, F.C. and H.V. Meredith "The Physical Growth of Alabama White Girls Attending WPA Preschools" Child Development, Vol. 13, 1942, pp. 165-194.
42. Meredith, H.V. "Size and Form of Boys of U.S.A. - North European Ancestry Born and Reared in Oregon" Growth Vol. 15, 1951, pp. 39-55.
43. Eppright, E.S. and V.C. Sidwell. "Physical Measurements of Iowa School Children" Journal of Nutrition, Vol. 54, 1954, pp. 543-556.
44. Meredith, H.V. and V.B. Knott. "Descriptive and Comparative Study of Body Size of United States Schoolgirls" Growth Vol. 25, 1962, pp. 283-295.
45. Department of Health, Education and Welfare. Ten State Nutritional Survey. PHS Publication no. 72-8130-33, 1972.

46. Rauh, J.L., D.A. Schumsky, and M.T. Witt, "Height, Weights and Obesity in Urban School Children" Child Development, Vol. 38, 1967, pp. 515-530.
47. Bakwin, H. and R.M. Bakwin. "Body Build in Infants: V. Anthropometry in the New-Born," Human Biology, Vol. 6, 1934, pp. 612-626.
48. Bakwin, H. and R.M. Bakwin. "Body Build in Infants: I. The Technique of Measuring the External Dimensions of the Body in Infants," Journal of Clinical Investigation, Vol. 10, 1931, pp. 369-375.
49. Kasius, R.V., A. Randall, W.T. Tompkins, and D.G. Wiehl. "Maternal and New-Born Nutrition Studies at Philadelphia Lying in Hospital," The Milbank Memorial Fund Quarterly, Vol. 35, 1957, pp. 323-372.
50. Burdi, A.R., D.F. Huelke, R.G. Snyder, and G.H. Lowrey. "Infants and Children in the Adult World of Automobile Safety Design: Pediatric and Anatomical Considerations for Design of Child Restraints," American Society of Mechanical Engineers, Paper no. 69-BHF-10, Journal of Biomechanics, Vol. 2, no. 3, 1969, pp. 267-280.
51. Bennett, H.E. School Posture and Seating. Ginn & Co., Boston, 1928.
52. O'Brien, R. Children's Body Measurements for Sizing Garments and Patterns. Bureau of Home Economics, U.S. Department of Agriculture, Washington, D.C. Misc. Publ. No. 365, 1939.
53. O'Brien, R. Body Size Measurements of American Boys and Girls for Garment and Pattern Construction. Bureau of Home Economics, U.S. Department of Agriculture, Washington, D.C. Misc. Publ. No. 366, 1941.
54. Stayton, M.E. Heights for High School Clothing Laboratory Tables Based On Measurements of 100 Girls. Unpublished master thesis. Oregon State College, Corvallis, Oregon, 1938.
55. Anderson, D.I. Dimension Standards for a High School Foods Laboratory. Unpublished Master's Thesis. Oregon State College. Corvallis, Oregon, 1941.
56. Martin, W.E. Basic Body Measurements of School Age Children. U.S. Department of Health Education, and Welfare, Office of Education. Washington D.C. June, 1953.
57. Martin, W.E. The Functional Body Measurements of School Age Children. The National School Service Institute, Chicago, 1954
58. Martin, W.E. Children's Body Measurements for Planning and Equipping Schools. U.S. Department of Health, Education, and Welfare, Office of Education. Washington, D.C. Special Publication No. 4, 1955.
59. Damon, A., H.W. Stoudt, and R.A. McFarland. The Human Body In Equipment Design. Harvard University Press, Cambridge, (revised 1974), 1966.
60. Stoudt, H.W., A. Damon, and R.A. McFarland. "Heights and Weights of White Americans," Human Biology, Vol. 32, 1960, pp. 331-341.

61. McConville, J.T., and E. Churchill. Source Data for the Design of Simulated Children's Body Forms. U.S. Department of Health, Education and Welfare, Public Health Service, Washington, D.C., July, 1964.
62. Krogman, W.M. The Growth of Philadelphia School-Age Children, 6-14 Years, Studied Serially, 1948- 1958; a Decennial Report. Philadelphia Center for Research in Child Growth, Philadelphia, 1959.
63. Krogman, W.M. "Growth of Head, Face, Trunk and Limbs in Philadelphia White and Negro Children of Elementary and High School Age." Monographs of Society for Research in Child Development, Vol. 35, May 1970, pp. 1-80.
64. Krogman, W.M. and F.E. Johnston. "The Physical Growth of Philadelphia White Children, Age 7-17 Years". Philadelphia Center for Research in Child Growth, Philadelphia, 1965.
65. Vickers, U.S. and H.C. Stuart. "Anthropometry in the Pediatrician's Office: Norms for Selected Body Measurements Based on Studies of Children of North European Stock" Journal of Pediatrics, Vol. 22, 1943, p. 155.
66. Palmer, C.E., "Studies of the Center of Gravity in the Human Body" Child Development, Vol. 15, Nos. 2-3, June, September, 1944, pp. 99-148
67. Swearingen, J.J. and J.W. Young. Determination of Centers of Gravity of Children Sitting and Standing. Federal Aviation Agency Office of Aviation Medicine, Oklahoma City. Report No. AM 65-23. August, 1965.
68. Swearingen, J.J., J.M. Badgley, G.E. Braden, and T.F. Wallace. "Determination of Centers of Gravity of Infants," Preprints, Scientific Program, Aerospace Medical Association, San Francisco, May 5, 1965, pp. 235-236.
69. Malina, Robert M., Peter V.V. Hamill and Stanley Lemeshow. Selected Body Measurements of Children 6-11 Years. U.S. Department of Health, Education and Welfare, Public Health Service, Health Resources Administration. NCHS Series 11, No. 123, January, 1973.
70. Hamill, P.V.V., F.E. Johnston, and S. Lemeshow. Height and Weight of Children: Socioeconomic Status. United States. U.S. Department of Health, Education and Welfare, Public Health Service, Health Services and Mental Health Administration, Rockville, Md. Public Health Series 1000, Series 11, No. 119, October, 1972.
71. Hamill, P.V.V., F.E. Johnston, and S. Lemeshow. Height and Weight of Children. U.S. Department of Health, Education and Welfare, Public Health Service, Health Services and Mental Health Administration, Rockville, Md. Public Health Series 1000, Series 11, No. 104, September, 1970.
72. Johnston, F.E., P.V.V. Hamill, and S. Lemeshow. Skinfold Thickness of Children 6-11 Years. United States. U.S. Department of Health, Education and Welfare, Public Health Service, Health Services and Mental Health Administration, Rockville, Md. Public Health Series 1000, Series 11, No. 120, October, 1972.

73. Malina, R.M., P.V.V. Hamill, and S. Lemeshow. Body Dimensions and Proportions. White and Negro Children 6-11 Years. U.S. Department of Health, Education and Welfare, Public Health Service, Health Services and Mental Health Administration, Rockville, Md. Public Health Series 1000, Series 11, No. 143, December, 1974.
74. National Center for Health Statistics, Plan and Operation of a Health Examination Survey of U.S. Youths 12-17 Years of Age. Vital and Health Statistics, Washington, D.C. Public Health Service Publication No. 1000, Series 1, No. 8, 1969.
75. Hamill, P.V.V., F.E. Johnston, and S. Lemeshow. Height and Weight of Youths 12-17 Years. United States. U.S. Department of Health, Education and Welfare, Public Health Service, Health Services and Mental Health Administration, Rockville, Md. Public Health Series 1000, Series 11, No. 124, January, 1973.
76. Hamill, P.V.V., F.E. Johnston, and S. Lemeshow. Body Weight, Stature and Sitting Height: White and Negro Youths 12-17 Years. United States. U.S. Department of Health, Education and Welfare, Public Health Service, Health Services and Mental Health Administration, Rockville, Md. Public Health Series 1000, Series 11, No. 126, August, 1973.
77. Johnston, F.E., P.V.V. Hamill, and S. Lemeshow. Skinfold Thickness of Youths 12-17 Years. United States. U.S. Department of Health, Education and Welfare, Public Health Service, Health Services and Mental Health Administration, Rockville, Md. Public Health Series 1000, Series 11, No. 132, May, 1974.
78. Garn, S.M. "Automation in Anthropometry" American Journal of Physical Anthropology, Vol. 20, 1962, pp. 387-388.
79. Garn, S.M. and R.H. Helmrach "Next Step in Automated Anthropometry" American Journal of Physical Anthropology, Vol. 26, 1968, pp. 97-99.
80. Garn, S.M. and R.H. Helmrach, and A.B. Lewis "Transducer Caliper with Readout Capability for Odontometry" Journal of Dental Research, Vol. 46, nos. 1-2, 1967, p. 306.
81. Bullock, M.I. University of Greensland, Brisbane, Australia (personal communication), 1974.
82. Prahl - Andersen, B. "The Longitudinal Growth-Study of the University of Nijmegen" COMPTE RENDU DE LA X<sup>e</sup> REUNION DES EQUIPES CHARGEES DES ETUDES SUR LA CROISSANCE ET LE DEVELOPPEMENT DE L'ENFANT NORMAL. CENTRE INTERNATIONAL DE L'ENFANCE. TOME II, 1970, pp. 39-41.
83. Prahl - Andersen, B.A., J. Pollman, D.J. Roaben, and K.A. Peters "Automated Anthropometry" Am. J. Phy. Anthropol., Vol. 37, 1972, pp. 151-154.
84. Owings, C.L., R.G. Snyder, M.L. Spencer, and L.W. Schneider, NEW TECHNIQUES FOR INFANT AND CHILD ANTHROPOMETRY: MINI-COMPUTER CONTROLLED ANTHROPOMETRY AND CENTER OF GRAVITY MEASUREMENTS, Proceedings, American Journal of Physical Anthropology, February, 1974.

85. Snyder, R.G., M.L. Spencer, C.L. Owings, and L.W. Schneider, INFANTS AND CHILDREN ANTHROPOMETRY (L'ANTHROPOMETRIE DES ENFANTS ET DES NOURRISSIONS) Proceedings, International Research Committee on Biokinetics of Impacts, Biomechanics of Trauma in Children, Lyon, France, September, 1974, pp. 139-149.
86. Owings, C.L., L.W. Schneider, R.G. Snyder, and M.L. Spencer, COMPUTER CONTROLLED ANTHROPOMETRY: A PORTABLE SYSTEM FOR USE WITH INFANTS AND CHILDREN, Proceedings, Conference on Engineering, Medicine and Biology, October, 1974, p. 385.
87. Owings, C.L., L.W. Schneider, R.G. Snyder, and M.L. Spencer, A PORTABLE SYSTEM FOR INFANT AND CHILD CENTER OF GRAVITY MEASUREMENT. Proceedings, Conference on Engineering, Medicine and Biology, October, 1974, p. 375.
88. Snyder, R.G., C.L. Owings, M.L. Spencer, and L.W. Schneider, NEW TECHNIQUES FOR INFANT AND CHILD ANTHROPOMETRY: MINI-COMPUTER CONTROLLED ANTHROPOMETRY AND CENTER OF GRAVITY MEASUREMENTS (LA ANTROPOMETRIA Y LAS MEDIDAS DEL CENTRO DE GRAVEDAD DE LOS NINOS ESTADOUID IDENSES UTILIZANDO EL AVANZADO SISTEMA AUTOMATIZADO DE MICHIGAN DE LA MINI-CALCULADORA ELECTRONICA) Proceedings, American Anthropological Association, Mexico City, November, 1974, p. 133.
89. Daniels, G.S. The "Average Man"? Wright Air Development Center, Air Research and Development Command, Wright-Patterson Air Force Base, Ohio. Technical Note WCRD 53-7, December, 1952.
90. Moroney, W.F. "The Use of Bivariate Distributions in Achieving Anthropometric Comparability in Equipment Design" Part I: The Requirement." Proceedings of the 16th Annual Meeting of the Human Factors Society, October, 1972, pp. 16-18.
91. Smith, M.J. "The Use of Bivariate Distributions in Achieving Anthropometric Comparability in Equipment Design Part II: The Development." Proceedings of the 16th Annual Meeting of the Human Factors Society, October, 1972, pp. 19-23.

APPENDIX

PARTICIPATING SCHOOLS, DAY CARE CENTERS, NURSERIES AND CLINICS

ALACHUA COUNTY, FLORIDA

Baby Clinics:

Alachua Well Baby Clinic

ANN ARBOR, MICHIGAN

Public Schools:

Bach Elementary  
Carpenter Elementary  
Dicken Elementary  
Forsythe Junior High School  
Haisley Elementary  
King Elementary  
Pattengill Elementary

Private Schools:

Ann Arbor Montessori Center  
Children's House/Oak Trails  
Montessori  
Clonlara  
Gay-Jay Montessori  
St. Andrews Montessori

Private Homes:

B.G. Evenchick

Baby Clinics:

Child Health Baby Clinic  
University Hospital  
Child Health Baby Clinic  
St. Joseph's Hospital

Nursery Schools and Day Care Centers:

Children's Playschool  
Discovery Center  
Friendship International  
Island Country Day  
Jack and Jill Day Care  
Jack and Jill Nursery School  
& Kindergarten  
Little Angels  
Little Farms  
Little Folks Corner  
Little Lambs  
Meadowbrook Farm Learning Center  
Model Cities Day Care Center  
Perry Nursery  
Sherrill Cunningham  
Triangle Nursery School  
Washtenaw Community College  
Day Care

CHELSEA, MICHIGAN

Public Schools:

Beach Middle School  
Chelsea North Elementary  
Chelsea South Elementary

GAINESVILLE, FLORIDA

Baby Clinics:

Gainesville Baby Clinic

Public Schools:

Idylwild Elementary School  
Littlewood Elementary

MANCHESTER, CONNECTICUT

Nursery Schools and Day Care Centers:

Delmont Child Day Care Center  
and Nursery School  
Lutz Children's Museum  
Recreation Center

PORTLAND, OREGON

Day Care Centers:

Fruit and Flower Day Care  
St. Mark's Day Care Center  
St. Vincent de Paul Day Care  
Center  
West Hills School  
YMCA Latch Key Program

ROCHESTER, MICHIGAN

Day Care Centers:

Oakland University Toddler Center

SACRAMENTO, CALIFORNIA

Public Schools:

El Dorado Elementary School  
Summer Program

Private Schools:

Oak Park Methodist Church

SACRAMENTO, CALIFORNIA continued

Elder Creek Elementary School  
Summer Program

Women's Civic Improvement  
Center

Huntington Elementary School  
Summer Program

Sierra Elementary School  
Summer Program

Thomas Edison Elementary School  
Summer Program

TOLEDO, OHIO

Nursery Schools:

West Toledo Day Nursery

TUCSON, ARIZONA

Public Schools:

Ft. Lowell Elementary School

Tolson Elementary School

Van Buskirk Elementary School

White Elementary School

Nursery Schools:

Little Red Schoolhouse

Mary Moppet's

WORCESTER, MASSACHUSETTS

Public Schools:

May St. Elementary School  
Summer Program

Rich Square Elementary School  
Summer Program

Day Care Centers:

Living and Learning Center

Baby Clinics:

Woodland St. Clinic

YPSILANTI, MICHIGAN

Nursery Schools and Day Care Centers:

Arbor Park Nursery

Cherry Hill Nursery

Hilltop House

Little Red Schoolhouse

St. Luke's Day Care Center

Washtenaw County O.E.O. Day Care