

Technical Report Documentation Page

1. Report No.		2. Government Accession No.		3. Recipient's Catalog No.	
4. Title and Subtitle DEVELOPMENT OF ANTHROPOMETRICALLY BASED DESIGN SPECIFICATIONS FOR AN ADVANCED ADULT ANTHROPOMORPHIC DUMMY FAMILY, Volume 1				5. Report Date December 1983	
				6. Performing Organization Code	
7. Author(s) L.W. Schneider, D.H. Robbins, M.A. Pflüg, R.G. Snyder				8. Performing Organization Report No. UMTRI-83-53-1	
9. Performing Organization Name and Address The University of Michigan Transportation Research Institute 2901 Baxter Road Ann Arbor, Michigan 48109				10. Work Unit No. (TRAIS)	
				11. Contract or Grant No. DTNH22-80-C-07502	
12. Sponsoring Agency Name and Address U.S. Department of Transportation National Highway Traffic Safety Administration Washington, D.C. 20590				13. Type of Report and Period Covered FINAL REPORT Oct. 1980 - Dec. 1983	
				14. Sponsoring Agency Code	
15. Supplementary Notes Volume 2: Anthropometric Specifications for Mid-Sized Male Dummy Volume 3: Anthropometric Specifications for Small Female and Large Male Dummies					
16. Abstract Procedures and results are described in this volume as well as the rationale for determining the constitution of the advanced adult-dummy family and for sizing its members. Based on the study's selection criteria, volunteers from the local area were recruited for use in collecting anthropometric data that describe the seated posture, position, shape, and size of seated vehicle occupants. Data were collected in three separate measurement sessions: (1) measurement of subject in-vehicle position, (2) establishment of seat/subject interface contours in laboratory vehicle seat bucks, and (3) collection of seated anthropometry on subjects seated in contoured reference hardseats. The contoured seats were determined and fabricated for each of the three subject-size groups by combining seat contour data for subjects seated in vehicle seats from four different vehicle models. Surface landmark coordinates and seat contour data were determined using stereophotographic and film analysis techniques. Summary statistics of data collected are presented and the process of using these data to fabricate three epoxy/fiberglass dummy shells is described. Volume 1 also contains a summary of the data presented in Volumes 2 and 3, which describe the procedures used in developing the anthropometric specifications and contain more detailed results.					
17. Key Words Anthropomorphic Test Devices Anthropometry Seated Occupant				18. Distribution Statement Unlimited	
19. Security Classif. (of this report) None		20. Security Classif. (of this page) None		21. No. of Pages 426	22. Price

This document is disseminated under the sponsorship of the Department of Transportation in the interest of information exchange. The United States Government assumes no liability for the contents or the use thereof.

NOTICE

The rights, welfare, and informed consent of the volunteer subjects who participated in this study were observed under guidelines established by the U.S. Department of Health, Education and Welfare Policy (now Health and Human Services) on Protection of Human Subjects and accomplished under medical research design protocol standards approved by the Committee to Review Grants for Clinical Research and Investigation Involving Human Beings, Medical School, The University of Michigan.

ACKNOWLEDGEMENTS

The authors wish to gratefully acknowledge the cooperation and assistance provided this multidisciplinary effort by a large number of dedicated and talented individuals over the past thirty-six months. In particular, several members of The University of Michigan faculty and staff served as co-investigators or consultants to the project. Dr. Clyde L. Owings, Associate Professor of Pediatrics and Electrical Engineering, and Denis Lee, Professor of Art and Medical Illustration, served as co-investigators in the initial planning stages of the project and contributed to the technical design of the measurement frame and the sculpting of the clay forms, respectively. Also, Dr. Anthony Schork, a biostatistician with the School of Public Health, assisted with the analysis of the HANES data and statistical design for subject sampling. Appreciation is also due to Nabih Alem of UMTRI, who developed the DLT photogrammetry programs, and to John W. Melvin and Kathleen Weber for their technical and administrative assistance and consultation in the latter stages of the study. Special recognition is due to Mark Haffner, contract technical manager with NHTSA, who is primarily responsible for the project design and whose insight and contributions throughout the study were key to the successful conduct and completion of the work.

Professional contributions and guidance were given throughout the course of the project by a number of individuals who gave generously of their time to comment on various technical aspects. In particular, J. Smrcka and S. Alderson were consultants to the project and offered advice and direction regarding the format and utility of the deliverables from the dummy manufacturer perspective. Special thanks are also due to: R.F. Chandler, J.T. McConville, R.P. Hubbard, H.M. Reynolds, R. Daniel, H.J. Mertz, J. Brinn, W. Fan, G. Nyquist, S.A. Backaitis, C.M. Haslegrave, D. Hammond, and R. Roe. The authors are also grateful to S. Abraham, E. Johnston, S. Garn, R. Frishancho, R. Maliva, H. Stoudt, J. Young, and A. Roch, who provided valuable assistance and consultation in the search for secular growth data.

The authors also wish to acknowledge the many talented persons within and outside of the University who assisted with many important aspects of the study. Thanks go to J. LeBlanc and M. Simon for their dedication to the tedious job of sculpting the clay models to measurement specifications; to S. Verish and T. Arnold for fabrication of the plaster molds and epoxy/fiberglass shells; to R. Donaldson, R. Dunham, and W. Black of The University of Michigan Ship Hydrodynamic Model Shop for their patience and skill in making the contoured mahogany seats; to J. Lehman for his expert assistance with data analysis and computer programming throughout the many phases of the project; to K. Crockett Richards for her skill and dedication to the illustrations and engineering drawings; to J. Boissonneault for his expertise in finishing and painting the surface shells and reference hardseats; to D. Erb and D. Hindal for fabrication of mechanical components and hardware; to J. Brindamour for his excellent photographic work; to G. Czynski, C. Donahey, and J. Delisi for their assistance with

subject scheduling and data collection; to C. Sobecki and B. Ball for their preparation of interim reports; to J. O'Day for analysis of NCCSS accident data; M. Ducharm for her many hours of tedious film digitizing; and to P. Cunningham, the University contract representative who handled the difficult contract negotiations. Special recognition and thanks is due L. Ricci for her careful and dedicated efforts in editing and preparing the final copy of this report.

The authors are particularly grateful to Richard Staloch and the 3M Corporation for donating the Scotchcast material to the project, to Dick Scott and R. Warneke of Ford Motor Company for assistance with J826 H-point procedures, and to I. Nakagawa of MMC Services, Incorporated for providing the specifications needed on the Plymouth Champ vehicle.

Finally, we wish to acknowledge the many people in and around Ann Arbor, without whose willing participation as subjects this study could not have been conducted.

VOLUME 1: CONTENTS

LIST OF TABLES	vii
LIST OF FIGURES	xi
LIST OF APPENDICES	xvii
1.0 INTRODUCTION	1
1.1 Background and Statement of the Problem	1
1.2 Project Objectives	2
2.0 CONSTITUTION OF DUMMY FAMILY MEMBERS	3
2.1 Applications and Uses of Test Dummies	3
2.2 Representation of Height and Weight Variability	4
2.3 Use of International Data Bases	5
2.4 Secular Trends in Body Size	8
2.4.1 Examination of Recent U.S. Population Data	10
2.4.2 Other Considerations Regarding Secular Trend in Human Size	17
2.4.3 Decision on Sizing Strategy Adjustments and Other Factors	18
2.5 U.S. Population Versus Injured Occupant Population	19
2.6 Constitution and Sizing of Dummy Family	22
2.6.1 Small and Large Dummy-Family Members	22
2.6.2 Race and Age Considerations	23
2.6.3 Mid-Sized Dummy-Family Members	24
2.7 Summary of Family Constitution and Subject Selection Criteria	25
2.8 Comparison of Dummy Sizes with Selected Populations	27
3.0 MEASUREMENT OF VEHICLE-SEATED ANTHROPOMETRY	33
3.1 Introduction	33
3.2 Vehicle and Vehicle Seat Selection	35
3.2.1 Vehicle Dimensions	35
3.2.2 Vehicle Type	37
3.2.3 Seat Selection	38
3.3 Subject Recruitment	39
3.4 Phase I Testing: Subject Screening and Acquisition of In-Vehicle Data	40

3.5	Development of Vehicle Seat Bucks for Phase II Testing	43
3.5.1	Simulation of Vehicle Seating Packages	43
3.5.2	Simulation of Driver Configurations	48
3.6	Phase II Testing: Measurement of Seated Posture and Seat/Subject Interface Contours	50
3.6.1	Stereophotogrammetry Data Collection System	52
3.6.2	Phase II Protocol: Seated Posture	54
3.6.3	Phase II Protocol: Seat Casting	56
3.6.4	Phase II Sampling Strategy	61
3.6.5	Phase II Data Analysis	62
3.7	Fabrication of Contoured Hardseats	64
3.8	Phase III Testing: Standard Anthropometry and Hardseat Measurements	73
3.8.1	Phase III Subject Samples	73
3.8.2	Standard Anthropometry	77
3.8.3	Measurements in the Contoured Hardseats	77
3.8.4	Data Analysis and Results	82
3.9	Comparison of Phase II and Phase III Surface Landmark Coordinates	95
3.10	Results Relative to Vehicle Reference System	101
4.0	FABRICATION OF STANDARD REFERENCE FORMS AND SEAT ASSEMBLIES	107
4.1	Seat Assembly Platform and Three-Dimensional Measurement Apparatus	107
4.2	Construction of Clay Models	109
4.3	Fabrication of Molds and Epoxy Shell Surface Forms	114
5.0	DEVELOPMENT OF ANTHROPOMETRIC SPECIFICATION PACKAGE	127
5.1	Introduction	127
5.2	Landmarks Used for Subject Definition	128
5.3	Development of Standard Seat Coordinate System	131
5.4	Subject Data Translated to Standard Seat Coordinate System	134
5.5	Segmentation and Linkage Selection	135
5.6	Construction of Segmentation Planes	136
5.7	Development of Anatomically Based Segment Coordinate Systems	139
5.8	Volume, Mass, and Inertial Properties	139
5.9	A Model for the Location of Joint Centers	141
5.10	Joint Parameters	143
6.0	REFERENCES	173
	APPENDICES	179

LIST OF TABLES

		<u>Page</u>
2.1	Comparison of Mean U.S. Male Stature Values for Different Ages in the HES and HANES Data	11
2.2	Estimates of Stature Changes Due to Secular Trend Factors in 1960-62 HES Data Based on Biological Stature Decreases from Gsell (1967)	14
2.3	Estimates of Stature Changes Due to Secular Trend Factors in 1971-74 HANES Data Based on Biological Stature Decreases from Gsell (1967)	14
2.4	Differences in Mean Stature Values Between the 1960-62 HES Data and the 1971-74 HANES Data for Equal Age Categories	15
2.5	Height and Weight Percentile Values for 18- to 74-Year-Old U.S. Male Populations	20
2.6	Height and Weight Percentile Values for 18- to 74-Year-Old U.S. Female Populations	21
2.7	Height and Weight Selection Criteria	26
2.8	Calculated Percentiles of Stature and Weight for U.S. Injured Occupant Populations Based on Assumption of Normal Distributions and Means and Standard Deviations from Nyquist (1977)	30
2.9	Injured Driver and Passenger Percentiles for the 5th, 50th, and 95th HANES Height and Weight Percentile Values	31
2.10	Height and Weight Percentiles of Dummy-Family Members for Selected International Populations	32
3.1	Vehicle Interior Volume	35
3.2	Vehicle Front-Seat Measurements	37
3.3	Phase I (In-Vehicle) Measurements and Protocol	42
3.4	Mean Values of Phase I Measurements by (a) Subject Group, (b) Vehicle, (c) the Sixteen Subject Group/Vehicle Categories	46
3.5	Final Vehicle Seat Buck Dimensions	51
3.6	Buck Seat Detent Settings	51

3.7	Phase II Surface Landmarks for Photogrammetry	56
3.8	Mean Values of Anthropometric Measurements for Subject Samples Used in Phase II	62
3.9	Sitting Height Percentile Values from Analysis of Preliminary HANES Data	74
3.10	Mean Values of Standard Anthropometry	78
3.11	List of Surface Landmarks	80
3.12	Anthropometric Measurements Taken in Contoured Hardseats	83
3.13	Mean Values of Contoured Hardseat Anthropometry	88
3.14	Mean Values of Surface Landmark Laboratory Coordinates .	90
3.15	Mid-Sized Male Surface Landmark Laboratory X- and Z- Coordinate Statistics for Phase II With and Without Scotchcast on Vehicle Seat	96
3.16	Mid-Sized Male Surface Landmark Laboratory X- and Z-Coordinate Statistics for Phase II in Scotchcast vs. Phase III in Hardseat	97
3.17	Phase III Laboratory Coordinates of Design H-Points . . .	101
3.18	Design H-Point Shift Due to Detent Round-Off	103
3.19	Adjusted Design H-Point and Accelerator Heel Point Laboratory Coordinates for Composite Vehicle	103
3.20	Phase III Laboratory Coordinates for Palpated and Reconstructed Trochanterion	104
3.21	Laboratory Coordinates of Reconstructed Hip Pivot Points	105
5.1	List of Surface Landmarks for Segment and Joint Definition (Original Requirements)	149
5.2	Landmarks Used in Construction of Segment Anatomical Coordinate Systems	150
5.3	Landmarks Used in Constructing Segmentation Planes . . .	151
5.4	Surface Landmarks Relative to H-Point	152
5.5	Formulation of Segmentation Planes	154
5.6	Locations of Origins of Segment Anatomical Coordinate Systems	155
5.7	Anatomical Axes with Respect to Hip Point Axis System . .	156

5.8	Estimated Segment Mass and Volume	159
5.9	Location of Estimated Segment Centers of Gravity with Respect to Whole-Body Coordinate Systems	160
5.10	Location of Estimated Segment Centers of Gravity with Respect to Segment Coordinate Systems	161
5.11	Estimated Segment Inertial Properties	162
5.12	Principal Axes of Inertia with Respect to Anatomical Axes	163
5.13	Principal Axes of Inertia with Respect to Hip Point Axis System	166
5.14	Location of Joint Centers	169
5.15	Range-of-Motion Data	171

TABLES IN APPENDICES

A.1	Mean Values of Phase I Measurements for All Subjects Combined	A - 6
A.2	Mean Values of Phase I Measurements by Subject Group . .	A - 7
A.3	Mean Values of Phase I Measurements by Vehicle	A - 8
A.4	Mean Values of Phase I Measurements by Group/Vehicle . .	A - 9
B.1	Vehicle Design Specifications	B - 2
B.2	Coordinates of Steering Wheel and Seat Track Mounting Bolts in Vehicle Reference Systems	B - 2
B.3	Seat Track Mounting Dimensions for Plymouth Champ	B - 3
B.4	Vehicle and Buck Dimensions Used to Locate Steering Wheel Center Relative to 3/4-Inch Seat Mounting Board . .	B - 3
B.5	Description of H-Point Procedure Used to Calibrate Seat Bucks	B - 4
B.6	Comparison of Vehicle H-Point Design Specifications Achieved in Vehicle Seat Bucks with Actual Values	B - 5
C.1	Glossary of Abbreviated Terms Used in Seat Buck Development	C - 5
C.2	Parameter Values Used in Development of Vehicle Seat Bucks	C - 7

C.3	Mean Values for Measured and Calculated Parameters Used in Seat Buck Development	C - 8
C.4	Final Vehicle Seat Buck Dimensions	C - 9
C.5	Buck Seat Detent Settings	C - 9
H.1	Index to Hardseat Measurements	H - 3
I.1	Small Female Standard Anthropometry	I - 2
I.2	Small Female Contoured Hardseat Anthropometry	I - 3
I.3	Small Female Surface Landmark Laboratory Coordinates	I - 5
I.4	Mid-Sized Male Standard Anthropometry	I - 10
I.5	Mid-Sized Male Contoured Hardseat Anthropometry	I - 11
I.6	Mid-Sized Male Surface Landmark Laboratory Coordinates	I - 13
I.7	Large Male Standard Anthropometry	I - 18
I.8	Large Male Contoured Hardseat Anthropometry	I - 19
I.9	Large Male Surface Landmark Laboratory Coordinates.	I - 21
K.1	List of Surface Landmarks	K - 2
L.1	Small Female Surface Shell Anthropometry	L - 2
L.2	Small Female Surface Shell Landmark Laboratory Coordinates	L - 4
L.3	Mid-Sized Male Surface Shell Anthropometry	L - 9
L.4	Mid-Sized Male Surface Shell Landmark Laboratory Coordinates	L - 11
L.5	Large Male Surface Shell Anthropometry	L - 16
L.6	Large Male Surface Shell Landmark Laboratory Coordinates	L - 18

LIST OF FIGURES

		<u>Page</u>
2-1	Comparison of stature and weight distributions for selected available international populations	7
2-2	Secular increase in stature of young European and Japanese males: 1840-1960	9
2-3	Secular trend in stature for young U.S. males: 1870-1980	9
2-4	Mean values of U.S. male stature by age group from 1960-62 HES and 1971-74 HANES data	12
2-5	Comparison of mean male stature values by age group from 1971-74 HANES data with values predicted from 1960-62 HES data and aging effects from Gsell	15
2-6	Stature distributions for injured occupants showing limits of subject selection criteria for the four dummy-family members	28
2-7	Weight distributions for injured occupants showing limits for subject selection criteria for the four dummy-family members	29
3-1	Project flow chart	34
3-2	Subject consent form	41
3-3	Mid-sized male subject sitting in Malibu showing little or no difference between "normal" and "standardized" seated postures	44
3-4	Small female subject sitting in Ford Escort showing a significant difference between "normal" and "standardized" seated postures	45
3-5	J826 H-point machine validation of vehicle seat bucks . .	48
3-6	Features of vehicle seat buck used for Phase I measurements	49
3-7	Phase II measurement buck with Malibu seat, toeboard, and steering wheel swung out of position	51
3-8	Schematic drawing of seven-camera stereophotogrammetry system	53
3-9	Target array for calibration of seven-camera stereophotogrammetry system	53

3-10	Mid-sized male seated in Malibu seat on buck	55
3-11	Mid-sized male holding probes on pelvic landmarks	55
3-12	Placing Scotchcast on vehicle seat	57
3-13	Mid-sized male seated in Scotchcast on vehicle seat	59
3-14	Seat casting fastened back in frame support after removal of vehicle seat	60
3-15	Comparison of midline contours from seat castings of a mid-sized female sitting in the four vehicle seats	61
3-16	Midline contours for eight mid-sized male seat castings merged on unloaded seat geometry	65
3-17	Midline contours for eight mid-sized male seat castings merged on iliac spines	65
3-18	Midline $X_L Z_L$ plane cross-section contours for merged and averaged seat castings of the three subject groups	66
3-19	Three-dimensional plot for the mid-sized male hardseat contour	66
3-20	Composite of $X_L Z_L$ plane contours for the small female hardseat at the centerline and at one-inch intervals along the Y_L axis	68
3-21	Early construction of the mid-sized male hardseat	69
3-22	Later construction of the mid-sized male hardseat	70
3-23	Placement of three contoured hardseats on buck relative to the 3/4-inch plywood mounting board	72
3-24	Hardseat buck for mid-sized males	72
3-25	Distribution of stature for Phase III subjects	75
3-26	Distribution of weight for Phase III subjects	75
3-27	Distribution of erect sitting height for Phase III subjects	76
3-28	Distribution of buttock-knee length for Phase III subjects	76
3-29	Contrast targets being placed at surface landmarks on seated subjects	79
3-30	Pre-photo measurement of chest height (nipple)	84

3-31	Mid-sized male subject seated in hardseat buck illustrating sequence of subject positions for photogrammetry	85
3-32	Measurement of arm circumference during Phase III	86
3-33	Measuring contour of shoulder with large contour gauge	86
3-34	Comparison of Phase II surface landmark coordinates for mid-sized males sitting in vehicle seats with and without casting material	98
3-35	Comparison of surface landmark coordinates for mid-sized males sitting in vehicle seats with casting material and sitting in reference hardseats	99
3-36	Comparison of reconstructed H-points with average design H-point and seat midline contours	106
4-1	Three-dimensional measurement apparatus used to construct clay models	108
4-2	Adjustable skeletal armature used for mid-sized male clay model	110
4-3	Fabrication of steel armature for large male model	112
4-4	Attaching styrofoam to welded steel armature	112
4-5	Modeling the mid-sized male with Plasticine	113
4-6	Completed mid-sized male clay model	113
4-7	Sculpting the small female model using HBX-2 clay	115
4-8	Completed small female clay model with lines for digitizing surface outlines	116
4-9	Completed large male clay model with lines for digitizing surface outlines	116
4-10	Placing metal shim stock into completed clay model to divide plaster mold into sections	118
4-11	Making plaster/hemp mold	118
4-12	Hardened plaster mold ready for removal from clay	119
4-13	Removing plaster mold parts from small female clay model	119
4-14	Laying-up epoxy/fiberglass in mold parts	120
4-15	Assembling mold parts on hardseat to lay-up back side of shell using seat as the mold	121

4-16	Removing mold parts from assembled shell	121
4-17	Finishing and painting the assembled shells	122
4-18	Small female completed seat assembly and shell	123
4-19	Mid-sized male completed seat assembly and shell	124
4-20	Large male completed seat assembly and shell	125
4-21	Completed seat assemblies with shells for the three dummy-family members	126
5-1	Anthropometric specifications for mid-sized male dummy .	129
5-2	Pelvic coordinate system superimposed on UMTRI lab-based coordinate system	133
5-3	Construction of thorax and abdomen segmentation planes .	137
5-4	Illustrations of range-of-motion definitions	145

FIGURES IN APPENDICES

A-1	Examples of the "standardized normal driving posture" for the four subject groups in the Ford Escort and Plymouth Champ	A - 2
A-2	Examples of the "standardized normal driving posture" for the four subject groups in the Chevrolet Malibu and Chevrolet Citation	A - 3
A-3	Examples of the "standardized normal driving posture" for eight mid-sized males in the Chevrolet Malibu	A - 4
A-4	Examples of the "standardized normal driving posture" for eight mid-sized males in the Ford Escort	A - 5
C-1	Basic features of the vehicle seat buck	C - 4
C-2	Adjustments to heel position due to shoe heel thickness .	C - 6
C-3	Geometric estimation of heel position from centerline . .	C - 9
D-1	Age distributions for Phase III subjects	D - 2
D-2	Stature distributions for Phase III subjects	D - 3
D-3	Weight distributions for Phase III subjects	D - 4
D-4	Erect sitting height distributions for Phase III subjects	D - 5
D-5	Buttock-knee length distributions for Phase III subjects	D - 6

F-1	Phase III measurements on a mid-sized male: pre-photo anthropometry, photogrammetry positions, post-photo measurements, and body contours	F - 2
G-1	Body orientation terms for surface landmark definitions in the standing posture	G - 3
G-2	Body orientation terms for surface landmark definitions in the seated posture	G - 4
J-1	Constructing and sculpting the mid-sized male clay model using a "skeletal" armature and Plasticine clay . .	J - 2
J-2	Completing and validating the mid-sized male clay model and fabricating the multipiece plaster mold	J - 3
J-3	Assembling and finishing the epoxy/fiberglass shell for the mid-sized male	J - 4
J-4	Constructing and sculpting the large male clay model using a welded steel armature, styrofoam, and industrial styling clay	J - 5
J-5	Completing the large male clay model and making the plaster/hemp mold	J - 6
J-6	Laying up epoxy/fiberglass in mold parts and assembling the large male shell	J - 7
J-7	Constructing and sculpting the small female clay model using a welded steel armature, styrofoam, and industrial styling clay	J - 8
J-8	Making the plaster/hemp mold and epoxy/fiberglass shell for the small female	J - 9
J-9	Finishing, priming, and painting the assembled large male and small female epoxy/fiberglass shells	J - 10

LIST OF APPENDICES

	<u>Page</u>
A. In-Vehicle Photographs and Measurement Results	A - 1
B. Vehicle Package Dimensions and J826 H-Point Procedures . .	B - 1
C. Development of Vehicle Seat Buck Parameters	C - 1
D. Distributions of Age, Stature, Weight, Sitting Height, and Buttock-Knee Length for Phase III Subjects	D - 1
E. Standard Anthropometry Definitions	E - 1
F. Photographs of Phase III Measurements in the Contoured Hardseats	F - 1
G. Surface Landmark Definitions	G - 1
H. Anthropometric Measurements in Contoured Hardseats	H - 1
I. Phase III Measurement Results (Statistics)	I - 1
J. Photographs of Clay Model Development and Epoxy/Fiberglass Shell Fabrication	J - 1
K. Photographs of Surface Shells with Surface Landmark Identification Numbers	K - 1
L. Comparisons of Desired and Actual Values for Seated Anthropometry and Surface Landmark Coordinates for the Surface Shells	L - 1

1.0 INTRODUCTION

1.1 Background and Statement of the Problem

This document constitutes the final report for U.S. DOT contract no. DTNH22-80-C-07502, "Development of Anthropometrically Based Design Specifications for an Advanced Adult Anthropomorphic Dummy Family." The work and results described are the product of a multidisciplinary research program conducted within the Biosciences Division of the University of Michigan Transportation Research Institute (UMTRI, formerly HSRI), with the assistance and cooperation of University personnel from the Department of Medical Sculpture in the School of Art, the Department of Biostatistics in the School of Public Health, and the program of Biomedical Engineering.

Conducted over a three-year period, from October 1980 to October 1983, this study represents the initial phase of the NHTSA advanced dummy development program described by Backaitis and Haffner (1979) and involves the anthropometric definition of the advanced dummy family. As described in the request for proposals (U.S. DOT 1980) for this contract:

Currently, dummy anthropometry is based primarily upon the specifications of SAE J963 for the 50th percentile male and upon the "golden shell" surface forms (Radovich and Herron 1974) existing for the 5th percentile female, 50th percentile male, and 95th percentile male. The data underlying these existing specifications were assembled in the late 1960s, primarily based upon a series of standard anthropometric measurements. The degree to which these measurements can be adapted to the automotive seating posture is not fully known, but it is clear that additional data are required to define realistic human automotive seating posture in typical vehicle environments.

The general goal of this study, then, has been to determine the anthropometric specifications for members of the advanced dummy family. As also stated in the request for proposals (U.S. DOT 1980):

The development of sound anthropometrically based design specifications for the advanced dummy family will provide the foundation necessary for all subsequent program activity. . . .

1.2 Project Objectives

Within this overall goal, to develop and define the anthropometric specifications of the new generation of automotive-seated dummies, four primary objectives were defined:

1. Develop a soundly based rationale for the constitution of an advanced anthropomorphic dummy family.
2. Collect data from human volunteers describing representative automotive vehicle-seated posture and body surface geometry for application to dummy design.
3. Develop anthropometrically based design specification packages describing body segment masses and mass distribution, joint locations and ranges of motion, surface geometry, etc., by incorporating information existing in the anthropometric literature with data collected in this study.
4. Fabricate standard reference contoured hard-surfaced seats (i.e., hardseats) and standard reference hard-shell surface forms corresponding to each dummy family member identified under objective 1.

The remainder of this report describes the procedures used and results obtained in carrying out these objectives. Section 2 describes the rationale for selecting the dummy family members and their basic sizing criteria. Section 3 describes the experimental procedures used to collect the anthropometric data related to automotive-seated posture for each of the defined subject groups and presents the results obtained for each. Section 4 describes the process of fabricating the standard reference surface forms from these data and illustrates the final deliverable products. Section 5 provides a summary of the anthropometric specification packages which are contained in Volumes 2 and 3 of this report. Section 6 lists the literature referenced in this report, and Appendices A through L provide greater detail on procedures and results referred to in the body of the report. In addition, full-size front, side, and top view engineering drawings illustrating the anthropometric specifications of each size dummy are a part of this three-volume report, as are full-size front and side view illustrations of the mid-sized male with renderings of internal skeletal geometry.

2.0 CONSTITUTION OF DUMMY FAMILY MEMBERS

In accordance with contractual requirements, the first step toward developing anthropometric specifications for the next generation of anthropomorphic test devices (ATDs) was to determine the constitution of the dummy family. Decisions concerning the number and sizes of dummies comprising the U.S. DOT advanced dummy family required consideration of several issues, including: (1) the applications of ATDs, (2) representation of population variability in height and weight, (3) inclusion of international anthropometric data bases, (4) secular trends in population anthropometry projected to the 1990s, (5) injured occupant population statistics, and (6) anthropometric factors related to age, sex, and race. The following sections present the rationale for dummy family constitution based on these considerations.

2.1 Applications and Uses of Test Dummies

Simply stated, anthropomorphic test dummies for the automotive industry have two principal uses. The first, and most important from NHTSA's perspective, is their use as human surrogates in dynamic (impact) testing. The second, which is of primary importance to automotive human factors engineers, is their use as human surrogates for seat and restraint system accommodation. The former is an application in a dynamic mode and includes both barrier crash and sled impact testing to:

1. Evaluate restraint system performance of belts, airbags, knee bolsters, energy-absorbing steering columns, etc.
2. Evaluate vehicle interior designs with respect to contact areas and injury potential of interior components.
3. Develop and evaluate protection systems for public transportation (e.g., buses, vans, trains, and aircraft) and for special populations, such as the handicapped and elderly.

In contrast, use of ATDs as human surrogates for vehicle accommodation and design is an application in a static sense.

In both types of application, however, the members of the advanced ATD family must first and foremost be regarded as "tools" possessing two critical dimensions, mass and size. In dynamic testing, for example, the dummy's mass (and mass distribution) is the key parameter in evaluating component strength and energy-absorbing properties, while stature and measures closely correlated with stature (e.g., sitting height, leg length, etc.) play an important role in determining the dynamic interaction of the surrogate with occupant restraints and interior vehicle components. In seating accommodation, dummy mass is an important factor influencing seat deflection, which, along with dimensions of lengths and breadths, determines locations and design of interior packaging components and seating.

2.2 Representation of Height and Weight Variability

A single test dummy designed from either U.S. or world population data is frequently discussed by automotive engineers. One cannot argue with the point that one test device simulating the "average" or "universal" person is attractive from an economic point of view. However, the main problem with this approach is that one of anything does not provide information about the effects of parameter variability for the range of a population. If one is dealing with a specific population where the range of important parameters is small (e.g., the weight of all thoroughbred race-horse jockies), then one test device may be sufficient to represent the population. For adult motor vehicle occupants, however, the range of the critical parameters of height and weight is large, whether one is dealing with the U.S. adult population or an international data base.

Within the U.S. population alone, body mass and stature range from 5th percentile female values of 47 kg (104 lbs.) and 151 cm (59.5 in.) to 95th percentile male values of 102 kg (225 lbs.) and 187 cm (73.5 in.), respectively (Abraham et al. 1979a). Not only does sound engineering design practice dictate designing for a minimum of 90 percent of potential users (certainly a conservative bracket where safety is a primary issue), but two or more data points are required for interpolation over the range of variability. Those experienced with

impact testing can attest to dynamic response sensitivity to changes in mass and linkage dimensions and to the fact that reasonable estimates for small and large members of the population cannot be made by extrapolating from a single data point somewhere in the middle. Similar considerations hold for applications in vehicle design and accommodation.

Thus, while economic considerations may dictate the frequent use of only one test device, provision must be made for the ultimate requirement to test over the range of important variables and to have results at two to three data points so that one can reasonably interpolate for interim values. Also, in many applications where only one dynamic test is conducted, use of extreme values (either low or high) may be more desirable and appropriate than use of average values.

2.3 Use of International Data Bases

In recent years, increasing sales of vehicles between countries has led to the concept of the "world car." While the extent to which this idea has, or will, become a reality can be questioned, it has nevertheless become more appropriate than ever before to consider the idea of international standards for automotive design and safety criteria. In the process of determining the constitution and sizing of the U.S. DOT family of dummies, therefore, consideration was given to the possibility and feasibility of utilizing anthropometric data from countries other than the United States. It soon became evident, however, that such an undertaking involved experimental, anthropometric, and political issues and decisions that were beyond the scope of the current project. Furthermore, it also became quickly apparent that the anthropometric data necessary to adequately approach the problem of dummy sizing from an international perspective was simply not available. It was therefore concluded that while the interest and justification for an internationally based set of anthropomorphic test devices is stronger than ever, it was premature and inappropriate to tackle this task in the current project. It may be useful, however, to highlight some of the issues involved.

Given that a primary reason for having a family of test devices is to bracket the population variables of size and mass, a first step toward an international set of dummies would be a careful analysis of stature and weight statistics for adult vehicle occupant populations in countries where the automotive market is significant. Such an analysis would attempt to target a new international population of vehicle users for which small, mid-sized, and large (with respect to height and weight) would be defined. For each individual country, however, it would also be important that the dummy-family members represented small, mid-sized, and large segments of the population, although clearly the heights and weights would represent different percentiles for different countries.

Successful accomplishment of this anthropometric analysis would not only involve an ability to define the "world population" of automobile users and thereby to weight the contributions of individual country height and weight data, but would also depend on the extent to which anthropometric dimensions vary in those countries comprising the target population. From the perspective of any single country (the United States, for example), such an international approach to dummy sizing would result in a set of test devices that would not bracket and represent that country's population as well as if international data were ignored. In addition, consideration must be given to the consequences of merging and blending racially related trait variability.

Even if one were willing to accept the compromises and successfully resolve the decisions involved with the above issues (which probably need to be handled by international standards committees and DOT personnel), one could not proceed to completion with the international approach due to the lack of available and up-to-date anthropometric data for populations of potential concern. The most complete and recent compilations of international anthropometric statistics by White (1975) and Annis (1978) clearly point out the fact that most anthropometric data are for narrowly defined subsets of populations (usually military), and that general population surveys required for the task at hand have not been conducted, have not been published, or are otherwise not available. Figure 2-1 graphically

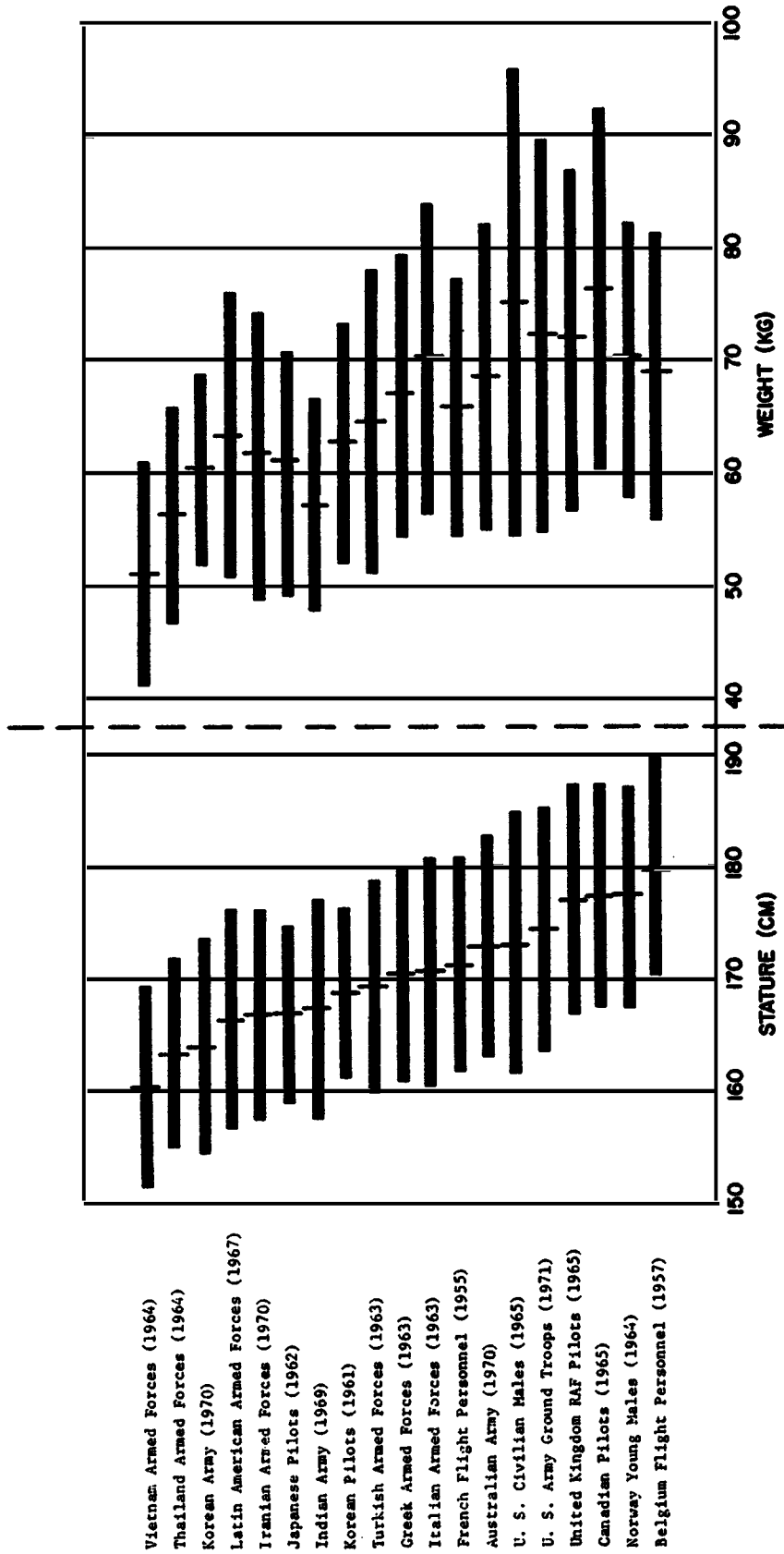


FIGURE 2-1. Comparison of stature and weight distributions for selected available international populations. Vertical lines indicate mean values while horizontal bars indicate 5th to 95th percentile ranges computed from population means, standard deviations, and assumption of normal distributions (data from White 1975).

illustrates some of these data and also indicates international population variability for height and weight of males. While these military data cannot be used to represent the variability in height and weight for the civilian populations, they do indicate the kind of variability that exists between populations from different countries. In particular, it is noted that for some of the Oriental countries, the mean values are near or even lower than the estimated 5th percentile values of some Western and European countries. Whether one would want to include the data from a given country would, of course, depend not only on whether that country represented a significant market for automobiles, but also upon the interests and goals of the organization or group developing the dummy standards. Nonetheless, the variability exhibited in Figure 2-1 gives some indication of the potential task involved in developing an internationally based family of ATDs.

While these brief comments provide justification for the decision to base the dummy sizes solely on the most recent U.S. population data contained in the 1974 Health and Nutrition Examination Survey (HANES) reported by Abraham et al. (1979a, 1979b), it is also true that the experimental protocol and size and complexities of the subject populations that would be required to do justice to an international approach would be prohibitive in both time and cost relative to the present level of effort. It is perhaps of some consolation, however, to recognize that the U.S. population of adult vehicle occupants covers a considerable range of height and weight variability, contains as good a blend of ethnic variability as one could find in any single country, and is not significantly different in height and weight statistics from many European countries (see Table 2.10).

2.4 Secular Trends in Body Size

It is fairly common knowledge that people today tend to be "bigger" than people several generations ago. Such variation in human body size over time is referred to by anthropologists as the "secular" trend in human growth. Primary documentation and quantification of this phenomenon comes from analysis of male military height and weight data, such as those summarized in Figures 2-2 and 2-3 for non-U.S. and U.S.

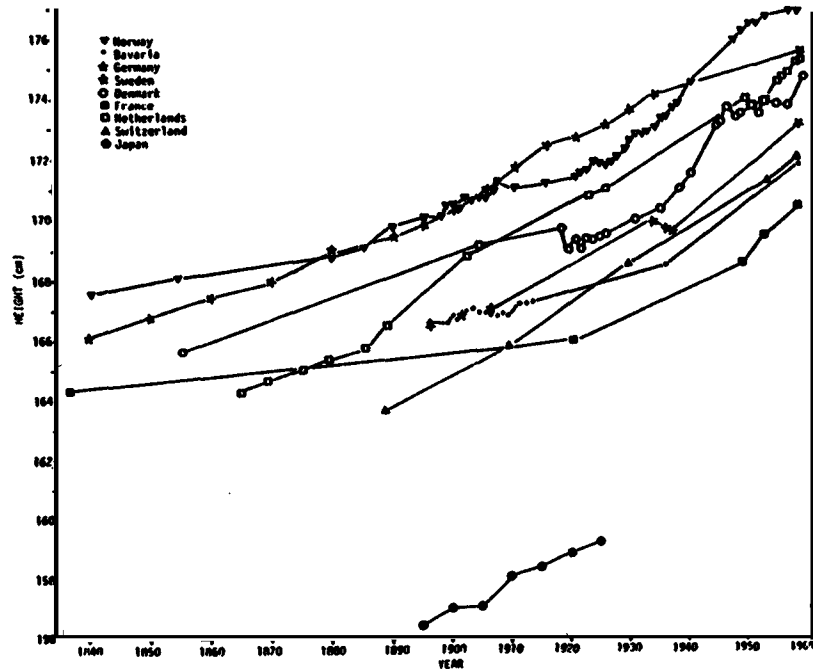


FIGURE 2-2. Secular increase in stature of young European and Japanese males: 1840-1960 (after Adjus 1964 and Harbeck 1960; from Annis 1978).

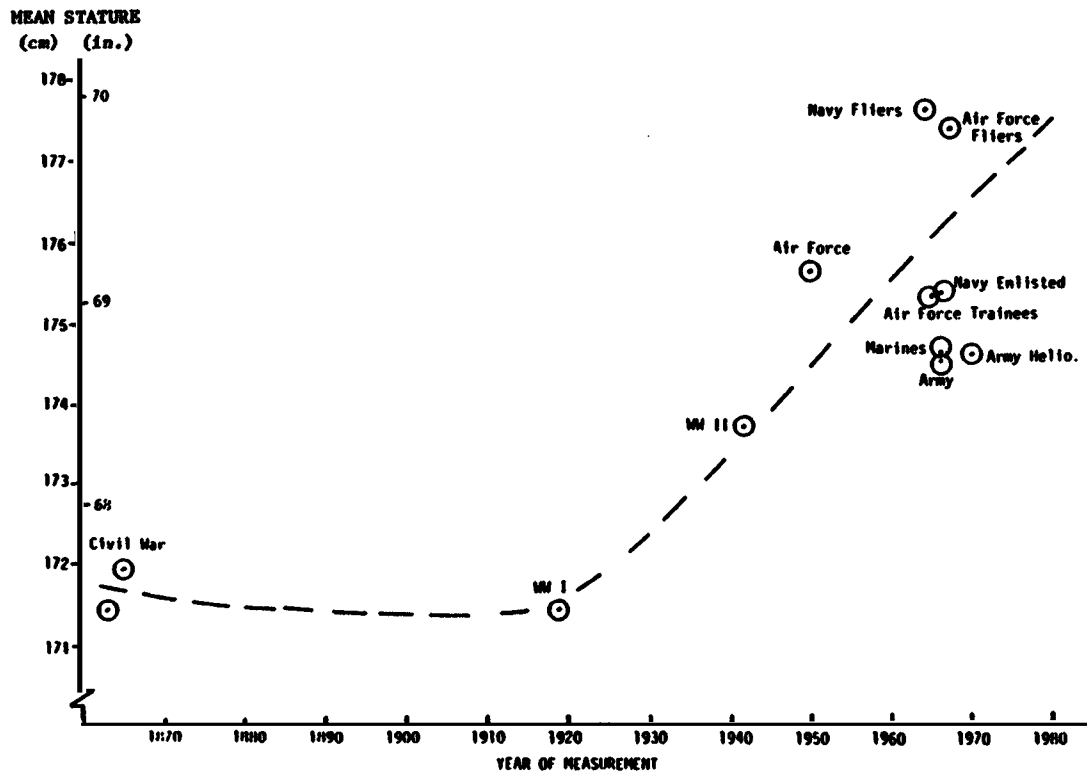


FIGURE 2-3. Secular trend in stature for young U.S. males: 1870-1980 (from Annis 1978).

data, respectively. In his 1978 SAE paper, Stoudt points out that, based on these data, the trend toward increasing body size has been "a world-wide phenomenon, at least in the technologically developed countries," with an overall magnitude of about one centimeter per decade in stature for the past one-hundred years. He further notes that the observed secular increase in body size is "an overall one, i.e., the body is increasing in gross size more or less proportionally," so that people are in general becoming "scaled up" in both size and weight.

For the present study, concern over this issue poses two important questions. First, what are the changes in human body size expected between the most recent and available U.S. population height and weight data (1971-74 HANES) reported by Abraham et al. (1979a, 1979b) and the application of the dummies in the 1990s? And second, should the sizing strategy based on HANES data incorporate any adjustments due to expected changes in human body size during this time period?

2.4.1 Examination of Recent U.S. Population Data. To answer the first question, it initially seemed that examination of recent height data from the U.S. population would provide an indication of the magnitude and significance of the secular trend for recent generations. At the beginning of this study in October of 1980, the most significant data of the U.S. general population were found in the series of U.S. Public Health Service studies conducted between 1959 and 1974. The first cycle of the Health Examination Survey (HES) included eighteen physical measurements taken on 6,672 persons aged 18-79 years in the civilian, non-institutional population from October 1959 through December 1962. These measurements have been reported for twelve dimensions in Stoudt et al. (1965) and for six dimensions in Stoudt et al. (1970).

A second study, conducted as part of the Health and Nutrition Examination Survey (HANES), collected height and weight data from April 1971 through June 1974 on 13,645 individuals representing the 128 million persons aged 18-74 in the U.S. population. These data have been reported by Abraham et al. (1979a, 1979b).

For purposes of analysis, Table 2.1 lists the mean male and female stature values for both the HES and HANES data by age category grouped by ten-year intervals. According to these data, over the full age range of 18 to 74 years, the mean height of all males in 1971-1974 was 0.8 inch (2.0 cm) greater than in 1960-1962, and the mean height of females was 0.6 inch (1.5 cm) greater in the later survey. On a per-decade basis, Stoudt (1978) points out that this amounts to a 1.7 cm per decade increase for males and a 1.3 cm per decade increase for females. He concludes that, "On the basis of the most recent data available, this overall trend seems to be continuing." In fact, based on this comparison and previous documentation of a one centimeter per decade increase, one might easily conclude that the rate of stature increase is increasing. Further examination of these data, however, indicates that there are problems with either or both of these data sets (perhaps sampling differences) that may lead to erroneous conclusions with regard to secular increases in stature when the two sets of data are compared in the above manner.

TABLE 2.1
COMPARISON OF MEAN U.S. MALE STATURE VALUES* FOR
DIFFERENT AGES IN THE HES AND HANES DATA

Age Category (Yrs.)	Approx. Mean Age (Yrs.)	MALES		FEMALES	
		1960-62 HES	1971-74 HANES	1960-62 HES	1971-74 HANES
18-74	--	68.2	69.0	63.0	63.6
18-24	20	68.7	69.7	63.8	64.3
25-34	30	69.1	69.6	63.7	64.1
35-44	40	68.5	69.1	63.5	64.1
45-54	50	68.2	68.9	62.9	63.6
55-64	60	67.4	68.3	62.4	62.8
65-74	70	66.9	67.3	61.4	62.3

*Stature given in inches.

To illustrate, Figure 2-4 shows a plot of the mean statures of males for different age groups from the HES and HANES studies. As

pointed out by Hertzog et al. (1969) and more recently by Borkan et al. (1983), the differences in mean stature between age groups can be accounted for by two factors. One is the biological aging factor by which people get shorter with increasing age. The other is the secular trend factor previously defined. For example, in comparing persons in the HES study in the 45-54 year category with persons in the HES study in the 55-64 year category, there is a 0.9 inch (68.3-67.4) difference in mean male statures. This difference can be due to the fact that the people who are 60 years old are shorter than when they were 50 (i.e., biological factor), and to the fact that the people who are 50 years old in the HES study represent a later generation than those who are 60 in the HES study and therefore may have grown taller due to secular trend factors acting on their generation. This is also true for the HANES data or for any cross-sectional data in which measurements are taken at the same time across age groups (as opposed to longitudinal data measured from one time to another on the same population).

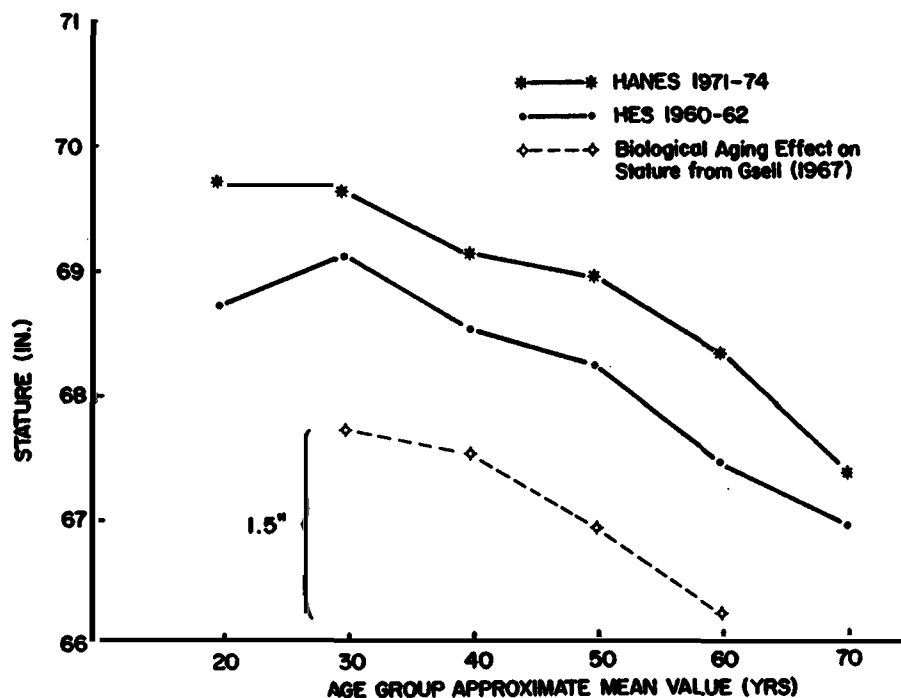


FIGURE 2-4. Mean values of U.S. male stature by age group from 1960-62 HES and 1971-74 HANES data.

This being the case, if the amount of stature decrease due to biological aging between age groups is known, then the two factors can be separated, and, within the cross-sectional data of either the HES or HANES study alone, it should be possible to estimate the secular trend effect for previous generations represented by persons of different ages in the study. Annis (1978) reports on a longitudinal study by Gsell (1967) in which the decrease in stature with age was determined to be 0.2 inch from 30-40 years, 0.6 inch from 40-50 years, and 0.7 inch from 50-60 years. This amounts to a decrease of 1.5 inches (3.8 cm) in stature between 30 years and 60 years and compares favorably with that measured by Hertzog (2.82 cm) in females.

Applying these biological stature decreases to the differences between HES mean male stature values at ten-year intervals, and doing similarly for the HANES data, gives the results shown in Tables 2.2 and 2.3. For the HES data, this analysis suggests only a 0.2 inch overall secular increase over the 30-year span from the generation born around 1900 to that born around 1930. For the HANES data, the results suggest height and weight decreases over the 30-year span from the generation born around 1910 to that born around 1940. Even if the Gsell values of biological shrinkage were high by 0.5 inch over the 30-year span (i.e., 1.0 inch over 30 years instead of 1.5 inches), the average secular increase per decade over these generations in the two studies would be only 0.23 inch (0.6 cm) and 0.1 inch (0.25 cm), respectively. Yet, if one compares the mean stature values at any age interval between the HES and HANES data, the differences are substantially greater, as shown in Table 2.4. These differences must be solely attributable to secular increase between generations, since biological aging effects would presumably be the same for the same aged persons in each study.

Figure 2-5 examines this discrepancy between the data sets in another way. Since the HANES data were collected approximately ten years after the HES data, those persons who are 30 years old in the HES study should represent that portion of the population who are about 40 years old in the HANES study, and similarly for other age groups. Therefore one would expect the HANES study mean values for age groups 40 through 70 to be the same as the respective values for the 30- through

TABLE 2.2
ESTIMATES OF STATURE CHANGES DUE TO SECULAR TREND FACTORS
IN 1960-62 HES DATA BASED ON BIOLOGICAL STATURE
DECREASES FROM GSELL (1967)

Span of Mean Ages	HES Mean Stature Difference (in.)	Gsell (1967) Expected Biological Decrease (in.)	Difference Due to Secular Trend (in.)
30-40	0.6	0.2	0.4
40-50	0.3	0.6	-0.3
50-60	0.8	0.7	0.1
30-60	1.7	1.5	0.2

TABLE 2.3
ESTIMATES OF STATURE CHANGES DUE TO SECULAR TREND FACTORS
IN 1971-74 HANES DATA BASED ON BIOLOGICAL STATURE
DECREASES FROM GSELL (1967)

Span of Mean Ages	HANES Mean Stature Difference (in.)	Gsell (1967) Expected Biological Decrease (in.)	Difference Due to Secular Trend (in.)
30-40	0.5	0.2	0.3
40-50	0.2	0.6	-0.4
50-60	0.6	0.7	-0.1
30-60	1.3	1.5	-0.2

60-year age groups from the HES study, minus expected stature decrease due to biological aging. Again, using the data of Gsell, the arrows in Figure 2-5 indicate where one would expect the HANES data points to fall. Regardless of the accuracy of the aging factors used, it is clear that the 50-year-old mean stature in the HANES study should not be larger than the 40-year mean stature in the HES study (which it is), and

TABLE 2.4

DIFFERENCES IN MEAN STATURE VALUES BETWEEN THE
1960-62 HES DATA AND THE 1971-74 HANES DATA
FOR EQUAL AGE CATEGORIES

Age Span (Yrs.)	Difference Between HANES and HES (in.)
18-74	.8
18-24	1.0
25-34	.5
35-44	.6
45-54	.7
55-64	.9
65-74	.4

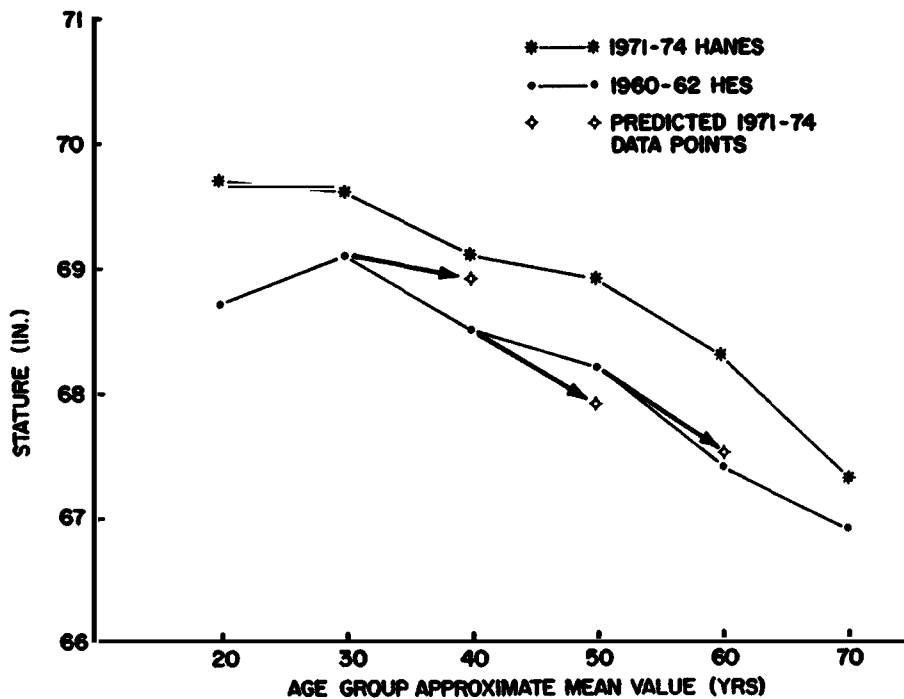


FIGURE 2-5. Comparison of mean male stature values by age group from 1971-74 HANES data with values predicted from 1960-62 HES data and aging effects from Gsell (1967).

similarly for the 60-year-olds in the HANES study who represent the same segment of the population as the 50-year-olds in the HES study.

In the preceding discussion, the 18-24 year olds (i.e., 20 years in Figures 2-4 and 2-5), representing those persons born around 1940 (HES study) and 1950 (HANES study), were not included, since these points may include persons who had not attained full stature. For the HES data, the increase in mean stature between 20 and 30 years may be due to continued growth in this period, but the difference (0.4 inch) may be somewhat large to be explained solely by this. Thus, if these points are accurate representations of the real world, they would suggest that little or no secular increase occurred between these age groups (i.e., between people born around 1930 and 1940). This, however, is inconsistent with the HANES data for 30 and 40 years (which are supposedly representing the same populations as the 20- and 30-year HES data) that indicate a 0.3 inch (0.8 cm) secular increase after correction for Gsell's aging factor. It is thus possible that either the 20- or 30-year HES data points, or both, are in error.

On the other hand, if there is a growth effect between the 20- and 30-year data points of the magnitude indicated by the HES study, then the HANES data at 20 and 30 years suggest a possibly significant secular increase in stature (perhaps 0.5 inch per decade¹) for males born around 1940 to those born around 1950.

Thus, while simple comparisons of mean stature values for 18-74 year males or females between the HES and HANES data indicate a significant increase in stature distribution for the U.S. population, closer analysis demonstrates that there are significant and unexplained discrepancies and incompatibilities between the studies that discredit these results. In fact, if any conclusion can be drawn from these data, it is that secular increases in stature over recent generations have been rather modest, a conclusion which may be inconsistent with what has been intuitively observed and with military data. In any case, it

¹For reasons discussed earlier regarding discrepancies between the two data sets, the secular increase between persons born in 1950 and 1940 would not be equal to the difference between HES and HANES 20-year-old mean values.

seemed evident that the most recent population data were of little value in shedding light on the secular trend in body size for the general population in recent generations, and even less useful with regard to estimating expected changes in height and weight statistics between 1974 and 1990.

2.4.2 Other Considerations Regarding Secular Trend in Human Size. Regardless of how one interprets the recent U.S. Public Health Survey data with regard to a secular trend, there are many experts who believe that we are near the end of increasing human size in the United States. Such opinions are based upon the belief reported by Stoudt (1978) that the primary factors responsible for the increases observed are "improvements in nutrition, both quality and quantity of food, and in health care and sanitation, especially in regard to the reduction of the major debilitating or growth-retarding illnesses of childhood." This hypothesis is supported by results of studies (Damon 1968, 1977; Bakwin and McLaughlin 1974; Maresh 1972; Bakwin 1964) that show no secular increase or change in subsets of the U.S. population in the upper socioeconomic status where improved diets and health care have stabilized. In addition, Hamill et al. (1977), in analyzing the National Center for Health Statistics data for children aged 2 to 18 years, reports that "in the analysis of these data, the marked diminution and near cessation of the trend to constantly increasing size of successive generations of American children is the most dramatic and significant finding relating to human biology and human growth in general."

Observations such as these, and the realization that by the mid-1970s the greater majority of the U.S. population had achieved socioeconomic levels where nutrition and health care were "uniformly favorable," have led Stoudt and others (e.g., personal communications with S. Abraham and S. Garn) to theorize that "the end is indeed in sight" and that "future changes can be expected to take place at a continually decreasing rate from the former high of about one centimeter per decade." If this theory is correct, then it would follow that persons attaining full stature in 1990 would not demonstrate an increase in stature over young adults in the early 1970s at the previously

documented rate of one centimeter per decade but, rather, might be expected to be taller (in the mean) by about one centimeter or less for the full time span of nearly two decades.

2.4.3 Decision on Sizing Strategy Adjustments and Other Factors. In view of these projections regarding a secular trend and a number of other considerations, a decision was made not to include any adjustments to HANES percentile values in the sizing strategy for the final dummy family members. Even if persons maturing during the 1970s and 1980s exhibit height and weight increases exceeding those expected, these persons would still only comprise a portion of the total 1990's population between 18 and 74 years, and the effects on overall adult statistics will be diluted. In addition, it can be expected that elderly persons will comprise a greater proportion of the U.S. adult population in the years ahead due both to advances in health care that increase life expectancy and to reductions in the birth rate. Since elderly persons are considerably shorter than young adults due to biological and secular trend factors, the effect of this shift in population age could compensate or significantly reduce any secular trend effects.

Furthermore, since the ATDs being developed are essentially test devices representing small, mid-sized, and large human bodies, the effect of an increase of one centimeter or two to three kilograms on subject recruiting criteria would likely have little effect on the dummies themselves and certainly no significant effect on the use and application of these test devices. Small increases in stature would tend to be masked within the variability of vehicle-seated posture and would be small compared to the variation in torso and leg lengths within each of the sample populations defined by stature limits. The effects of increasing weight by two or three kilograms would be distributed throughout the body and be unrecognizable in the anthropometrics of the final product.

There is also the very practical observation that, if the population percentiles of height and weight change over the years, which they no doubt will to some degree, the family of dummies developed using the 1974 HANES data will still be appropriate representations of small, mid-sized, and large adults for the U.S. population. It is only the

exact percentile of height and weight represented that would be changed. The mid-sized male, for example, may represent a 45th or 40th percentile male in stature, and the large male may represent a 90th percentile male in the year 2000. Both, however, would still represent mid-sized and large segments of the population, and, in that sense, would be valid test devices.

Finally, there was one other reason for not adjusting the HANES percentile values that relates to the decision not to include international anthropometric data. Since adult U.S. population percentile values for height and weight are generally larger than the respective percentiles in other populations of the world, adjusting the values up from the 1974 HANES values would tend to move the dummy sizes away from an internationally acceptable standard. Leaving the HANES percentile values alone tends to keep them closer to the small, mid-sized, and large values of other populations, especially if persons in other countries experience an increase in height and weight by the 1990s.

2.5 U.S. Population Versus Injured Occupant Population

Since almost every able-bodied adult in the United States uses the automobile, either as a driver or passenger, one would expect the population of adult automobile occupants to match closely to the U.S. adult population. The obvious choice of a data base for sizing the dummy-family members was therefore the latest available U.S. population survey data from the 1971-1974 Health and Nutrition Examination Survey (HANES). Since one of the principal uses of an ATD is in the evaluation of occupant protection systems, consideration was also given to designing the dummy family to match the population of injured occupants. This population differs from the general U.S. adult population in a number of ways, including differences related to frequency of driving and other driving habits as well as variability in susceptibility to injury. With this focus, injured-occupant data from the National Crash Severity Study (NCSS) (Ricci 1980; Gimotty et al. 1980) were analyzed, compiled, and compared to the HANES statistics for height and weight by age and sex groupings for drivers and passengers. Tables 2.5 and 2.6

summarize the results of this analysis for 18- to 74-year-old male and female populations.

TABLE 2.5
HEIGHT AND WEIGHT PERCENTILE VALUES FOR 18- TO 74-YEAR-OLD
U.S. MALE POPULATIONS

Percentile	HANES Males	NCSS Male Drivers	NCSS Male Pass.	NCSS AIS 3+ Male Dr.	NCSS AIS 3+ Male Pass.
HEIGHT (in)					
	(N=5,260)	(N=31,579)	(N=7,050)	(N=1,073)	(N=248)
5th	64.4	64.6	63.9	64.5	64.6
10th	65.5	66.0	65.9	65.8	65.8
25th	67.1	68.0	67.6	68.0	67.8
50th	69.0	70.1	69.7	70.1	70.1
75th	70.8	72.2	71.8	72.2	72.1
90th	72.6	73.7	72.9	73.8	73.8
95th	73.6	74.8	73.9	74.7	74.7
WEIGHT (lbs)					
	(N=5,260)	(N=31,311)	(N=7,046)	(N=1,049)	(N=247)
5th	128	132	131	132	126
10th	137	140	138	137	136
25th	152	152	149	151	149
50th	170	168	162	169	166
75th	189	186	178	188	182
90th	211	207	196	211	199
95th	225	225	209	225	215

Examination of these tables reveals some differences between the populations, but, when one considers sources of variability in the NCSS height and weight data (i.e., much of the NCSS measurement data were obtained from drivers' licenses and verbal statements and include significant rounding error), it must be concluded that the injured male and female populations of drivers and passengers are very similar to the U.S. populations of males and females by height and weight. Therefore, the 1971-1974 HANES data were maintained as the most suitable for developing the height and weight sizing criteria of the advanced dummy-family members.

TABLE 2.6

HEIGHT AND WEIGHT PERCENTILE VALUES FOR 18- TO 74-YEAR-OLD
U.S. FEMALE POPULATIONS

Percentile	HANES Females	NCSS Female Drivers	NCSS Female Pass.	NCSS AIS 3+ Female Dr.	NCSS AIS 3+ Female Pass.
HEIGHT (in)					
	(N=8,411)	(N=15,767)	(N=8,903)	(N=453)	(N=355)
5th	59.5	59.2	59.2	60.5	60.2
10th	60.5	60.1	60.0	61.6	60.8
25th	62.0	61.7	61.8	62.9	62.8
50th	63.7	63.6	63.5	64.7	64.9
75th	65.3	65.4	65.3	66.3	66.6
90th	66.8	66.8	67.0	67.9	68.4
95th	67.8	67.7	67.8	68.8	69.0
WEIGHT (lbs)					
	(N=8,411)	(N=15,670)	(N=8,803)	(N=444)	(N=355)
5th	104	103	103	102	105
10th	110	109	109	109	111
25th	122	118	117	121	119
50th	137	130	129	134	131
75th	159	146	147	151	148
90th	185	168	169	176	174
95th	203	183	187	188	188

Further investigation of the literature on injured automobile occupants confirmed this observation (Backaitis and Stephens 1976; Nyquist 1977) and suggests that:

1. There is little effect on injury severity rates due to height or weight variations of the occupant (Backaitis and Najjar 1980).
2. The average injured occupant is 20-24 years of age, male, has a weight of 76.4 kg (168 lbs.), and is 175.8 cm tall (69.2 inches).
3. The occupant's injury intensity appears to be sensitive to the occupant's weight and height.
4. Adult males and drivers have the highest incidences of injury (Backaitis and Najjar 1980).
5. About 67 percent of all drivers are males.

2.6 Constitution and Sizing of Dummy Family

In considering the final constitution of the dummy family, several factors needed to be considered. As previously discussed, the dummies must first of all possess specifically defined properties of both mass and size (e.g., stature or measures closely related to stature) in order to appropriately bracket and represent the variability of these parameters for the U.S. population. Secondly, consideration must be given to secondary factors, such as age, race, and sex, as well as the manner in which these factors influence the primary variables of size and mass. The ideal, in terms of representing all these factors, would be to provide an ATD to represent each segment of the population for all combinations of both primary and secondary factors. This, of course, is not even close to practical from either a dummy-development or user perspective. Compromises must be made in order to arrive at a reasonable set of dummy-family members.

2.6.1 Small and Large Dummy-Family Members. In order to bracket the population variability of both height and weight, dummies representing the small and large segments of the population by both of these variables are required. It was agreed that, in line with good engineering design practice, at least 90 percent of the population range should be bracketed. Since females comprise the majority of small persons and males the majority of large persons by height and weight, it was decided to follow with the traditional approach of using 5th percentile female height and weight values and 95th percentile male height and weight values to define small and large dummies, respectively. The resulting test devices will thereby bracket more than 90 percent of the population variability in both height and weight.

From the HANES data (Abraham et al. 1979a), it was determined that the 5th percentile female height and weight are approximately 59.5 inches and 104 pounds, and that the 95th percentile male height and weight are 73.6 inches and 225 pounds. Further analysis of the HANES data (Abraham et al. 1979b) reveals, however, that the mean weight of females who are 59.5 inches tall is not 104 pounds, but rather about 136 pounds, and that the mean weight of males who are 73.6 inches tall is not 225 pounds, but rather about 196 pounds. This incompatibility

between extreme percentiles in height and weight produces a dummy size that is representative of only a very small portion of the population when smallness or largeness are defined by height and weight simultaneously in the same ATD. This might at first suggest that an alternative approach to the sizing of the small and large dummy-family members be used.

It has been suggested, for example, that the small dummy should be sized to either the 5th percentile stature or weight and the other variable should be set to the mean or 50th percentile value for persons in the population defined by the first variable (e.g., the small female should be 59.5 inches in stature and 136 pounds). Such an approach ignores the fact discussed by Searle and Haslegrave (1970) and Hertzberg (1970) that the dummy is a test device in which both mass and size are present for somewhat independent purposes. The most important aspect is that they bracket the range of both these parameters, not that they represent a major segment of the population. As stated by Hertzberg (1970):

Human factors specialists in the United States have long accepted the view that designing to the range of accommodation is the only safe procedure; hence a dummy that will test equipment to its maximum in all parameters is essential. Thus the use of many parameters is not "meaningless;" it is in fact the efficient way to assure maximum utility and safety.

In other words, while combining either 5th percentile height and weight values or 95th percentile height and weight values in the same ATD results in a test device that actually represents an anthropologically rare individual, the approach makes good sense in terms of the ATD as an evaluation "tool" and was considered to be the appropriate sizing scheme for the small and large ATDs.

2.6.2 Race and Age Considerations. With regard to secondary factors, it was agreed from the outset that averaging or blending anthropometric trait variability across age and race would be necessary to attain a reasonably sized dummy family. Since the U.S. population was to be represented, efforts would be made to comprise each subject group by approximately ten percent non-Caucasian. Also, since injured population data indicate that young persons tend to be involved in

accidents more frequently and thus sustain more injuries, and that elderly persons tend to sustain more serious injuries, consideration was given to developing a sampling strategy for subject groups in which the age distributions would be biased toward the young and old.

The important question in regard to the latter point is whether the seated position and body shape differ significantly for young, middle-aged, and elderly persons within the same range of height and weight. Intuitively one would expect that there are some consistent differences in weight distributions for young and old persons of the same height and weight that would result in some differences. It is also likely that, by biasing the sampling to both the young and elderly, the differences would cancel and the net effect would be of little practical consequence. Considering the time and cost constraints and practical problems of recruiting enough subjects in "rare" combinations of height and weight, a decision was made to simply strive for representation of the full range of adults between 18 and 74 years.

2.6.3 Mid-Sized Dummy-Family Members. While it was agreed that averaging across age and race was necessary, the investigators were unanimous in the decision not to combine variability between males and females in one dummy, as some have suggested. This so-called "unisex" approach is generally expounded with regard to an average or mid-sized dummy. One could, for example, attempt to develop a single mid-sized dummy based on 50th percentile HANES height and weight for the combined male and female populations. Another suggestion has been to develop mid-sized dummies based on male and female height and weight distributions that have been combined to represent the typical injured driver and/or injured passenger. Taking either of these approaches appeared to offer no significant advantages that would offset the potential problems of recruiting subjects, averaging data, and developing a test device with questionable utility and interpretive value.

Rather, it was decided that two mid-sized dummies would be optimal, representing the 50th percentile U.S. female and 50th percentile U.S. male by both height and weight. Analysis of the HANES data revealed that this approach, combined with the small and large

sizes previously described, results in a set of four dummy members whose heights and weights form a rather evenly spaced progression from small to large in the U.S. population. It also results in one mid-sized dummy (i.e., the mid-sized male) whose height and weight match very closely to the injured population at highest risk, a male with height and weight of about 69 inches and 170 pounds.

2.7 Summary of Family Constitution and Subject Selection Criteria

As a result of the rationale and considerations highlighted in Sections 2.1 through 2.6, development of a four-member dummy family was recommended to the NHTSA as optimal. These four ATDs would consist of:

1. A *small female* whose height and weight are approximately the 5th percentile values for all U.S. adult females;
2. A *mid-sized female* whose height and weight are approximately the 50th percentile values for all U.S. adult females;
3. A *mid-sized male* whose height and weight are approximately the 50th percentile values for all U.S. adult males;
4. A *large male* whose height and weight are approximately the 95th percentile values for all U.S. adult males.

Percentile values were to be based upon the latest available U.S. height and weight data from the 1971-1974 HANES study and would not be adjusted for reasons of expected generational changes.

For the small and large ATDs, qualified subjects would have height and weight values within approximately $\pm 2\frac{1}{2}$ percentiles of the 5th or 95th percentile values, while for the mid-sized ATDs, qualified subjects would be required to have both height and weight within ± 10 percentiles of the 50th percentile values. Table 2.7 summarizes these height and weight selection criteria.

This plan for a four-member dummy family was submitted to the NHTSA along with three alternative plans considered less optimal for three-, two-, and one-member dummy families. The three-member family

TABLE 2.7
HEIGHT AND WEIGHT SELECTION CRITERIA

Group	HANES Percentiles	STATURE, cm (inches)		WEIGHT, kg (pounds)	
		Range	Desired Mean	Range	Desired Mean
Small Female	5th $\pm 2-1/2$	148.6-153.7 (58.5-60.5)	151.1 (59.5)	44.1- 48.6 (97-107)	47.3 (104)
Mid-Sized Female	50th ± 10	160.0-163.8 (63.0-64.5)	161.8 (63.7)	59.5- 65.9 (131-145)	62.3 (137)
Mid-Sized Male	50th ± 10	172.7-177.8 (68.0-70.0)	175.3 (69.0)	73.6- 80.5 (162-177)	77.3 (170)
Large Male	95th $\pm 2-1/2$	185.4-189.2 (73.0-75.0)	186.9 (73.6)	98.6-109.1 (210-240)	102.3 (225)

consisted of the same members but without the mid-sized female. Two options were proposed if a two-member family were chosen. One consisted of a 75th percentile male and a 25th percentile female by height and weight. The other consisted of a 95th percentile male and a 5th percentile female by height and weight. The one-member family consisted solely of the 50th percentile male proposed for the three- and four-member families.

While the four-member family was approved by NHTSA, it was later determined that the level of funding would not allow completion of the study for all four dummy members, and that the mid-sized female should be dropped. The resulting three-member dummy family would still bracket the range of important variables, provide for interpolation capability, and contain a dummy representing the segment of the population at highest risk, the mid-sized male.

2.8 Comparison of Dummy Sizes with Selected Populations

As a point of interest, Figures 2-6 and 2-7 show where the height and weight brackets for the four dummy selection criteria fall on distributions of injured drivers, injured front-seat passengers, and injured rear-seat passengers based on mean and standard deviation data from Nyquist (1977) and an assumption of normality for both height and weight distributions. Table 2.8 shows the percentile values calculated to develop these distributions, and Table 2.9 gives the driver and passenger percentiles for the HANES 5th, 50th, and 95th percentile values.

During the latter part of the study, recently collected height and weight data were obtained for British, French, West German, and Japanese civilian populations. Table 2.10 shows the means and standard deviations of height and weight for male and female segments of these populations and also shows the calculated percentiles of the dummy family members' heights and weights for these populations.

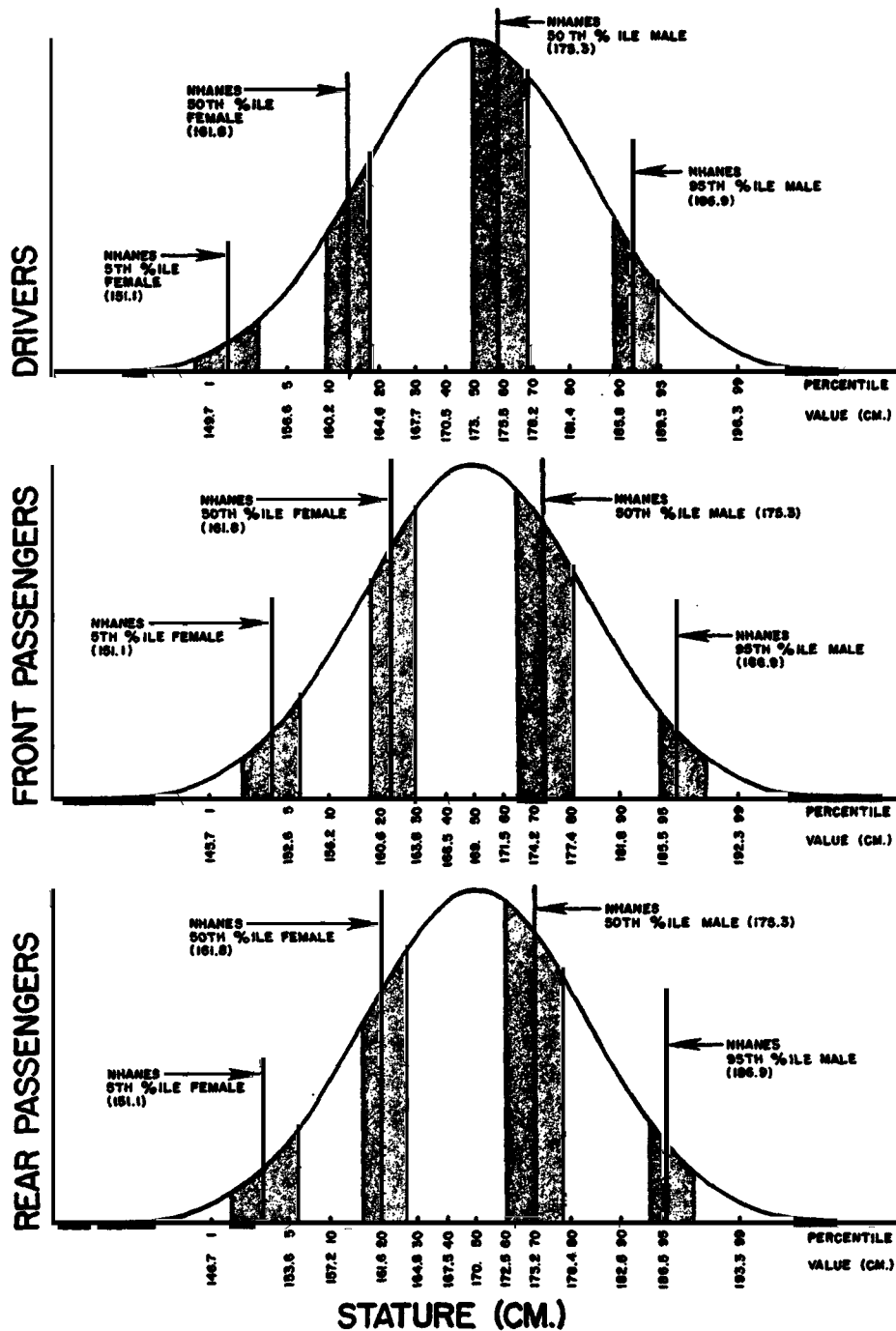


FIGURE 2-6. Stature distributions for injured occupants showing limits of subject selection criteria for the four dummy-family members. Distributions are based on means and standard deviations from Nyquist (1977) and assumption of normality.

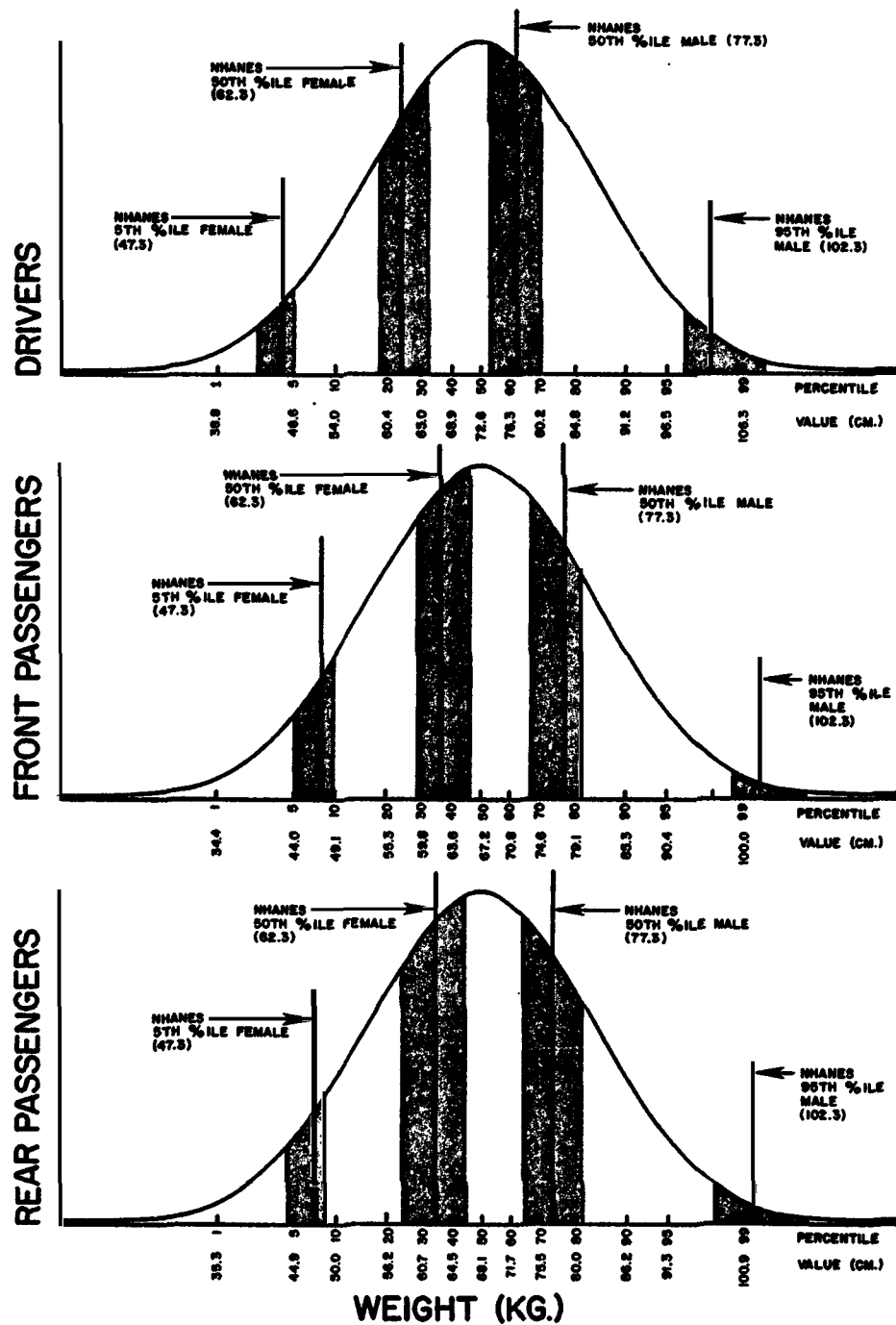


FIGURE 2-7. Weight distributions for injured occupants showing limits of subject selection criteria for the four dummy-family members. Distributions are based on means and standard deviations from Nyquist (1977) and assumption of normality.

TABLE 2.8

CALCULATED PERCENTILES OF STATURE AND WEIGHT FOR U.S. INJURED OCCUPANT POPULATIONS BASED ON ASSUMPTION OF NORMAL DISTRIBUTIONS AND MEANS AND STANDARD DEVIATIONS FROM NYQUIST (1977)

Percentile	METRIC UNITS						U.S. CUSTOMARY MEASURE					
	Weight (kg)			Stature (cm)			Weight (lbs)			Stature (in)		
	Driver	Front Pass.	Rear Pass.	Driver	Front Pass.	Rear Pass.	Driver	Front Pass.	Rear Pass.	Driver	Front Pass.	Rear Pass.
1	38.8	48.4	35.3	149.7	145.7	146.7	85.6	75.9	77.9	59.3	57.3	57.7
5	48.6	44.0	44.9	156.6	152.6	153.6	107.4	97.0	99.0	61.8	60.0	60.4
10	54.0	49.1	50.0	160.2	156.2	157.2	119.0	108.3	110.3	63.2	61.5	61.8
20	60.4	55.3	56.2	164.6	160.6	161.6	133.1	121.9	123.9	64.9	63.2	63.5
30	65.0	59.8	60.7	167.7	163.8	164.8	143.2	131.7	133.7	66.1	64.5	64.7
40	68.9	63.6	64.5	170.5	166.5	167.5	151.9	140.2	142.2	67.1	65.6	65.8
50	72.6	67.2	68.1	173.0	169.0	170.0	160.0	148.0	150.0	68.1	66.6	66.8
60	76.3	70.8	71.7	175.5	171.5	172.5	168.1	155.8	157.8	69.1	67.6	67.8
70	80.2	74.6	75.5	178.2	174.2	175.2	176.8	164.3	166.3	70.1	68.7	68.8
80	84.8	79.1	80.0	181.4	177.4	178.4	186.9	174.1	176.1	71.3	70.0	70.1
90	91.2	85.3	86.2	185.8	181.8	182.8	201.0	187.7	189.7	73.0	71.7	71.8
95	96.5	90.4	91.3	189.5	185.5	186.5	212.6	199.0	201.0	74.4	73.2	73.2
99	106.3	100.0	100.9	196.3	192.3	193.3	234.4	220.1	222.1	76.9	75.9	75.9
MEAN	72.6	67.2	68.1	173.0	169.0	170.0	160.0	148.0	150.0	68.1	66.6	66.8
STD. DEV.	14.5	14.1	14.1	10.0	10.0	10.0	32.0	31.0	31.0	3.8	4.0	3.9

TABLE 2.9

INJURED DRIVER AND PASSENGER PERCENTILES FOR THE 5th, 50th,
AND 95th HANES HEIGHT AND WEIGHT PERCENTILE VALUES

HANES Percentiles	Injured Drivers	Injured Front Seat Passengers	Injured Rear Seat Passengers
WEIGHT (kg)			
5th Female	4.1	8.0	7.1
50th Female	24.0	36.0	34.1
50th Male	62.5	76.4	74.0
95th Male	97.9	99.3	99.2
STATURE (cm)			
5th Female	.14	3.7	2.9
50th Female	13.1	23.6	20.6
50th Male	59.1	73.6	70.2
95th Male	91.8	96.3	95.4

*Normal distributions based on means and standard deviations from Nyquist (1977).

TABLE 2.10

HEIGHT AND WEIGHT PERCENTILES¹ OF DUMMY-FAMILY MEMBERS
FOR SELECTED INTERNATIONAL POPULATIONS

Population and Variable	\bar{X}	S.D.	%ile of Male or Female Population			
			Small Female	Mid-Sized Female	Mid-Sized Male	Large Male
BRITISH (17-86 yrs.) ²						
Male: Stature	173.8	6.8			59	97
Weight	74.3	11.2			60	99
Female: Stature	162.5	5.6	2	45		
Weight	62.1	9.5	6	51		
FRENCH (18+ yrs.) ³						
Male: Stature	173.3	6.4			62	98
Weight	N.A.	N.A.			--	--
Female: Stature	161.9	6.5	5	50		
Weight	N.A.	N.A.	--	--		
W. GERMAN (20-65 yrs.) ⁴						
Male: Stature	171.6	6.8			70	99
Weight	74.1	11.0			49	99+
Female: Stature	160.2	6.1	7	60		
Weight	59.5	10.0	11	61		
JAPANESE (31-40 yrs.) ⁵						
Male: Stature	166.6	5.3			95	99+
Weight	62.5	7.7			97	99+
Female: Stature	154.4	4.7	24	94		
Weight	52.0	6.2	22	95		

¹Percentiles determined by population mean, standard deviation, and values of normal distribution function (from Guttman and Wilks 1965).

²Haslegrave (1980).

³Rabiffe et al. (1982).

⁴Deutsches Institut für Normung (1979).

⁵Tokyo Metropolitan University, Physical Fitness Laboratory (1980).

3.0 MEASUREMENT OF VEHICLE-SEATED ANTHROPOMETRY

3.1 Introduction

This section describes the methods, procedures, and results related to the measurement of vehicle-seated posture and anthropometry for the subject groups defined in Section 2.7. Figure 3-1 shows a flow chart outlining the general approach, including the application of the acquired data to the development of standard reference forms and anthropometric specification packages described in Sections 4 and 5, respectively. As indicated, four 1981 vehicles were selected and obtained to represent a cross section of the current and expected passenger vehicle seat types and seat configurations. Subjects were recruited to match the four sets of height and weight criteria previously determined. Measurement of subjects was divided into three separate parts referred to as Phase I, Phase II, and Phase III in the remainder of this report.

Phase I testing consisted of qualification of subjects responding to advertisements as well as measurement and documentation of seated position in one of the four vehicles. Phase II testing involved measurement in vehicle seat bucks developed from vehicle-seated data and vehicle package drawings to: (1) determine general body posture and position, and (2) develop seat/subject interface contours.

Phase III testing was divided into two parts. In the first part, subjects were measured for traditional anthropometry in the standing and erect sitting postures. In the second part, and final session, subjects were seated in contoured "hardseats" developed from the seat/subject interface data for each subject group. Seated anthropometry and surface landmark coordinate data were obtained by standard and stereophotogrammetric procedures. These Phase III results comprised the data base for defining and developing the seated surface forms and anthropometric specification packages. The following pages describe these procedures and results in detail. Coordinate values presented in this section are in the laboratory reference system denoted by the subscript L.

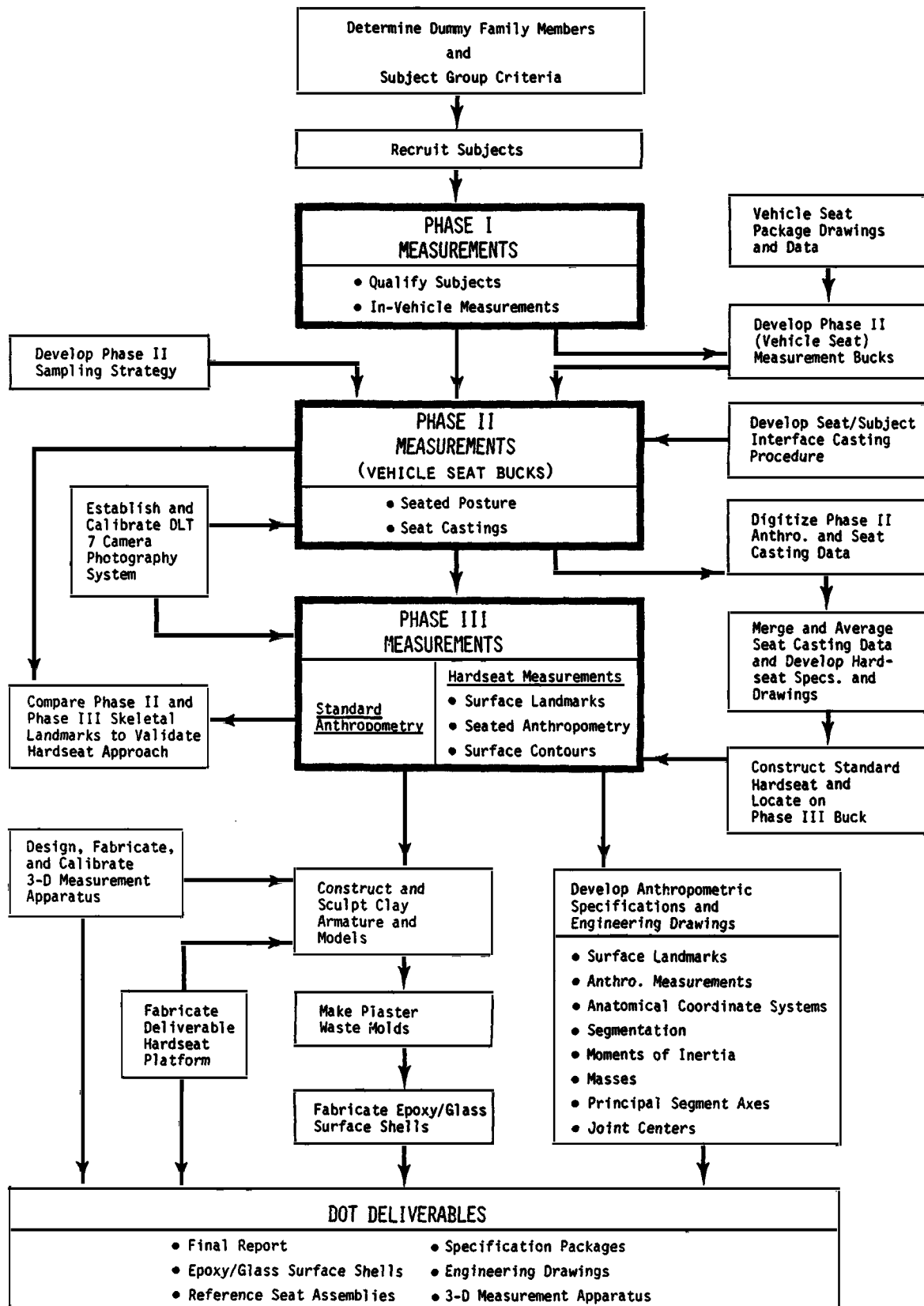


FIGURE 3-1. Project flow chart.

3.2 Vehicle and Vehicle Seat Selection

Selecting a set of representative vehicles and vehicle seats involved consideration of four primary criteria:

1. The vehicle seats should be of both bench and bucket seat configuration,
2. The vehicle seats should cover a range of stiffnesses,
3. The vehicles should include both foreign and domestic (U.S.) models,
4. The vehicle types should represent a projected 1985-1990 fleet.

To sort out the great variety of vehicle types, the selection process was begun by adapting the vehicle classification scheme of the EPA. In this scheme, five size classes of vehicles are defined based on computation of interior volume. Because of a general trend toward downsizing, the "large" category was eliminated from consideration. The final set consisted of four 1981 vehicles in the sub-compact and mid-size categories and included:

- a Plymouth Champ hatchback
- a Ford Escort 3-door hatchback
- a Chevrolet Citation 4-door hatchback
- a Chevrolet Malibu 4-door sedan

3.2.1 Vehicle Dimensions. Table 3.1 is a comparison of the four vehicles with respect to front seat volume, rear seat volume, cargo area volume, and total volume based upon the EPA classification scheme.

TABLE 3.1
VEHICLE INTERIOR VOLUME

Vehicle	Front Seat Volume (ft ³)	Rear Seat Volume (ft ³)	Cargo Area Volume (ft ³)	Total Volume (ft ³)
Champ	44.1	31.2	19.8	86.1
Escort	47.0	38.6	16.3	101.9
Citation	52.4	43.6	19.7	115.6
Malibu	54.8	47.3	16.6	118.7

The important parameter for the current contract is front seat volume, which shows a relatively even progression from the small to large vehicles (i.e., Plymouth Champ, Ford Escort, Citation, Malibu).

Using the EPA scheme, front seat volume was computed using four dimensions from SAE Recommended Practice J1100a, "Motor Vehicle Dimensions." The four dimensions, H61, W3, W5, and L34, are defined below in somewhat simplified terms:

- H61. Effective head room: front. The dimension measured along a line 8 degrees to the rear of vertical, from the seating reference point to the headlining plus 4 inches.
- W3. Shoulder room: front. The minimum dimension measured laterally between the trimmed vehicle surfaces from a point 10 inches above the seating reference point.
- W5. Hip room: front. The minimum dimension measured laterally between the trimmed vehicle surfaces from points in the range of 1 inch below to 3 inches above the seating reference point and 3 inches fore and aft of the seating reference point.
- L34. Maximum effective leg room: accelerator. The dimension measured along a line from the ankle pivot center to the seating reference point plus 10 inches measured with the right foot on the undepressed accelerator pedal.

Front seat volume (V), in cubic feet, was computed using the following formula:

$$V = H61 \times [(W3+W5+5)/2] \times L34/1728$$

Note that in the EPA definition the quantity in brackets is replaced by W3 unless W5 is less than W3 minus 5 inches (W5 is less than (W3-5)).

Table 3.2 contains the values of the various quantities for the four vehicles that were selected. There is a uniform increase in head (H61), shoulder (W3), and leg room (L34) as vehicle size class increases. Most noticeable is an increase of 6.2 inches in shoulder room (W3). Some inconsistencies appear to exist with respect to hip room (W5), probably due to interior door design details. The important leg and head room quantities that affect seating posture represent a range of potential vehicle seating packages.

TABLE 3.2
VEHICLE FRONT-SEAT MEASUREMENTS

Vehicle	H61 (in)	W3 (in)	W5 (in)	L34 (in)
Champ	38.8	51.0	51.6	40.6
Escort	38.0	51.5	52.0	41.5
Citation	38.1	56.3	55.1	42.2
Malibu	38.7	57.2	52.2	42.8

3.2.2 Vehicle Type. Selection of vehicles involved consideration of both domestic and foreign models as well as vehicles expected to represent the vehicle fleet of the late 1980s. These two criteria were considered qualitatively based on a number of conversations with the Contract Technical Manager, Motor Vehicle Manufacturers Association (MVMA) personnel, and individuals in the automobile industry. Most were unable to project what the vehicle fleet of the late 1980s would be.

As a result, discussions shifted to the presence of advanced designs in the current marketplace that were likely to have "staying power." The Plymouth Champ is an advanced design subcompact in its class. The Ford Escort represents a major attempt to provide a small, compact class of vehicles that are likely to remain through this decade. The Chevrolet Citation represents the General Motors X-body concept. It proved to be an immediate success in the marketplace and bodes well for vehicles in its class (the Chrysler K-cars are dimensionally very similar). The Chevrolet Malibu represents a traditional six-passenger vehicle. Most experts feel that cars in this size class will be around for the foreseeable future but others argue that the three-passenger front seat will soon disappear. The Malibu was selected as a representative large automobile, because its general occupant volume is expected to be maintained during the next down-sizing of the General Motors A-body vehicles. Front-wheel drive will also be included in this new package, so the selection of the Malibu to represent the largest size class of vehicles of the late 1980s appeared to be somewhat objective.

The four vehicles bear name tags of United States manufacturers. However, the Plymouth Champ was designed and manufactured in Japan. The Ford Escort was designed to compete in the international marketplace. The Citation and Malibu represent domestic designs. It was thought that selection of these vehicles represented balance of both domestic and foreign design concepts and should be valid for the remainder of the 1980s.

3.2.3 Seat Selection. Two factors were considered in selecting seats for the vehicles. The first factor was inclusion of both bench and bucket seat configurations, while the second had to do with seat stiffness. The two smallest vehicles, Champ and Escort, were equipped with front bucket seats. It is believed that all vehicles in their size classes are similarly equipped. The Citation has a split bench seat design, and the Malibu has a traditional front bench. Also, there are a number of structural differences between the seats selected that represent a range of stiffness.

A number of conferences were held with individuals in the automobile industry during the process of seat selection. Several pertinent comments were made.

1. A variation of as much as 1-1/2 inches in the location of the seating reference point might be expected between seemingly identical vehicles.
2. The length of time that a person sits in a seat and the age of the seat have a major effect on both stiffness and seating reference point location.
3. Vehicles ordered at different times during a model run may be equipped with seats that appear to be the same but actually have considerably different frame and foam components.
4. Seating foam is highly susceptible to batch differences resulting in variable stiffness.

It is recommended that these factors be studied more completely in future work to better define and quantify the variables of seat stiffness and occupant locations.

3.3 Subject Recruitment

Once the dummy family constitution and sizing strategy were approved by NHTSA, the task of establishing samples of human volunteers with heights and weights within the defined ranges for each of the anthropomorphic test dummies was begun. The initial sampling plan called for recruitment of fifty subjects in each of the four² groups for participation in Phase I (in-vehicle measurements) of the study. It was estimated, based on analysis of the HANES data, that the local population of 200,000 persons was comprised of about 7,000 individuals in each of the mid-sized groups, about 2,000 large males, and only about 800 small females. It was apparent that recruitment of the full sample of subjects in the extreme groups would be difficult.

A wide range of subject recruitment methods were utilized, including posters placed extensively around the community, advertisements in regional newspapers and on the radio, recruitment at a Michigan Technology Fair, use of the University of Michigan Periodic Health Unit that allowed access to height-weight records of faculty and staff members, recruitment through athletic departments of The University of Michigan, as well as direct communication with friends, family, and neighbors of project staff. In spite of these efforts, expected problems in recruiting subjects in the extreme groups were realized. Males who fit the "large" category for height were generally below the requirement for weight, and females who fit the "small" category for height were generally above the requirement for weight. After twenty weeks of recruiting, fifty mid-sized males and females had been approved, but only forty-one "small" females and thirty-five "large" males had qualified. Because of the necessity to move on with the study, it was concluded that these sample sizes would have to be sufficient in providing the in-vehicle measurement data needed to design the Phase II vehicle seat bucks.

²During this phase of the study, all four dummy-family members were being considered. The mid-sized female was dropped after Phase II data collection.

3.4 Phase I Testing: Subject Screening and Acquisition of In-Vehicle Data

Subjects responding to the various modes of advertisement were given a preliminary screening on the telephone with regard to their height, weight, general health, and availability for testing over the next six to twelve months. If responses to these initial questions were satisfactory, the potential subject was scheduled for the Phase I measurement session which had two purposes:

1. To substantiate that each prospective subject did indeed meet the height and weight criteria of one of the four categories.
2. To assess preferred occupant seated position, posture, and orientation in one of the four selected vehicles for design of the laboratory vehicle seat bucks.

Table 3.3 lists measurements taken in Phase I. Upon arrival at UMTRI, each subject was taken to a laboratory where stature, weight (without shoes), erect sitting height, and buttock-knee length were measured and recorded. The first two variables were used as primary selection criteria, while sitting height, buttock-knee length, age, and race were secondary variables. The subject's shoe-heel thickness was also measured at this time, and each subject was asked to sign a subject consent form shown in Figure 3-2, and to fill out a standard health questionnaire.

Each qualified subject was randomly assigned to one of the four vehicles and taken to the vehicle area for in-vehicle measurements. Subjects were asked to sit in the driver's seat and to adjust the seat to their preferred position in four separate trials. The seat track detent for each trial was recorded and the results averaged. With subjects seated in a preferred, relaxed driving position and posture and the right foot on the undepressed accelerator pedal, the fore-aft location of the right heel and the rotation and pitch angles of the right foot were measured and recorded. A lateral view photograph was taken as a qualitative record of the subject's seated posture. Figures A-1 through A-4 show a representative cross section of subjects seated in their preferred driving positions in the different vehicles.

SUBJECT CONSENT FORM

I, the undersigned, understand that the purpose of this study is to collect data of body measurements which describe the size and shape of persons sitting in car seats. These measurements will be used to develop forms for new automotive test dummies. The specific tests in which I will be asked to participate are divided into three parts.

In the first session a few basic measurements will be taken (height, weight, sitting height, buttock-knee length). I will also be asked to orient myself in a non-moving vehicle and perform some simple seat adjustments. In addition, a photograph will be taken.

In the second session, I will be asked to wear special light-weight clothing which will be provided. I will then be asked to sit in a vehicle seat in a laboratory while:

- 1) A seat casting is made of the seat cushion and seat back depression,
- 2) Photographs and measurements are taken of my head, spine, arms, torso, pelvis, legs and feet.

In the third session, I will be asked to sit in a hard surface seat in the laboratory while a complete set of measurements are taken.

I understand that the measurements will involve both manual and photographic techniques, the three sessions will be conducted on different days, the sessions will take 6-8 hours of my time (in total) and will take place over the next 8-10 months.

I acknowledge that I have received a complete briefing of this study and am satisfied that I understand what is involved. I have completed a standard health questionnaire and am aware that my participation in the actual tests is subject of the screening of the information I have provided on this form.

I also understand that I will be allowed at any time to discontinue my participation in this study without prejudice or change in my pay. I further acknowledge that all the data are confidential and I agree to allow publication of any or all of the data collected if presented in a coded form not identifying me.

I hereby consent to participate in the study.

Date

Signature of Subject

Date

Signature of Witness

FIGURE 3-2. Subject consent form.

TABLE 3.3

PHASE I (IN-VEHICLE) MEASUREMENTS AND PROTOCOL

- ANTHROPOMETRY
 - Stature
 - Weight (without shoes)
 - Erect sitting height
 - Buttock-knee length
 - SHOE HEEL THICKNESS
 - MEDICAL QUESTIONNAIRE
 - CONSENT FORM
 - IN-VEHICLE MEASURES
 - Seat detent, 4 trials
 - Accelerator heel position
 - Accelerator foot pitch and rotation
 - IN-VEHICLE PHOTOGRAPHS
 - Normal
 - Standardized
-

On occasion it was noted that, without some instruction, a subject would choose to sit in a rather atypical (but probably realistic) manner, such as with the buttocks and/or back away from the seat back. Such observations led to lengthy discussions of "realistic," "normal," and "typical" driving or vehicle-seated postures and resulted in general agreement of the necessity for some degree of similarity in seated postures between subjects within each group. It was also agreed that the intent of this study was not to analyze and include the range of driver or passenger postures and positions that one could observe in the "real world," and which vary substantially and include significant asymmetry.

Rather, the purpose of this study was to determine the body posture, shape, and position resulting from the seat package configurations, seat geometries, and seat deflection characteristics of vehicles typical of the present and future vehicle fleet. Without some similarity and standardization of the seated posture, averaging of data would become difficult and even meaningless. As a result, the term

"standardized normal driving posture" was adopted to mean a relaxed, comfortable, and typical driving posture with the constraint that the buttock contact the seat back/seat cushion interface and the back lie comfortably into the seat back. A second photograph was taken of subjects to document this "standardized normal driving posture" versus the uninstructed or "natural" posture. Generally, there was little noticeable difference between the two as shown in Figure 3-3. However, a few subjects, particularly in the small female group, demonstrated a significant variation as illustrated in Figure 3-4.

In Phase I testing, then, subject sample populations were established and vehicle-seated posture was assessed and documented within each morphological group for each vehicle type. Basic in-vehicle seat and subject position data were obtained and used with vehicle package drawings to establish dimensional features of the vehicle seat bucks as described in the next section and Appendices B and C. Tables 3.4(a) through 3.4(c) summarize the Phase I measurement results for the sixteen group/vehicle conditions. Tables A.1 through A.4 present the complete statistical tabulations of Phase I results.

3.5 Development of Vehicle Seat Bucks for Phase II Testing

3.5.1 Simulation of Vehicle Seating Packages. As mentioned, two data sets were used to design the seat bucks for Phase II measurements: vehicle data and subject data. Vehicle package drawings and vehicle dimensional data were used to determine the height of seat-track mounting spacers and the location and tilt of the steering wheel. These data ensured that each vehicle seat buck simulated the proper relationship of vehicle interior features relative to each other and the accelerator heel-point. Vehicle dimensional data utilized are summarized in Tables B.1 through B.4.

To validate proper seat location and orientation, the SAE J826 H-point machine was used to determine seat buck H-point parameters for comparison with the H-point design specifications of each vehicle. Since the bucks did not have an accelerator pedal, it was necessary to set and fix the accelerator heel-point of the H-point machine relative



FIGURE 3-3. Mid-sized male subject sitting in Malibu showing little or no difference between "normal" (above) and "standardized" (below) seated postures.



FIGURE 3-4. Small female subject sitting in Ford Escort showing a significant difference between "normal" (above) and "standardized" (below) seated postures.

TABLE 3.4 (a)

MEAN VALUES OF PHASE I MEASUREMENTS BY SUBJECT GROUP

Measurement	Small Females (N=41)	Mid-Sized Females (N=50)	Mid-Sized Males (N=53)	Large Males (N=33)
Age (years)	36.0	40.3	36.2	34.1
Stature (cm)	151.6	162.7	174.7	186.1
Weight (kg)	47.3	63.2	77.5	101.8
Erect Sitting Height (cm)	81.8	86.7	91.9	96.9
Buttock Knee Length (cm)	52.7	56.9	60.2	64.4
Heel Thickness (cm)	4.6	4.4	3.2	3.1
Detent	1.7	4.6	7.4	10.1
Bolt to Heel (cm)	45.7	46.1	45.1	44.6
Foot Pitch (Deg to Horiz)	56.9	58.1	59.0	55.0
Foot Rotation (Deg to Vert)	7.1	7.0	12.1	19.0

TABLE 3.4 (b)

MEAN VALUES OF PHASE I MEASUREMENTS BY VEHICLE

Measurement	Malibu (N=44)	Citation (N=44)	Escort (N=47)	Champ (N=42)
Age (years)	40.2	37.5	34.7	35.3
Stature (cm)	168.4	168.0	168.9	166.9
Weight (kg)	71.4	71.1	72.2	69.1
Erect Sitting Height (cm)	89.3	88.5	89.6	88.6
Buttock Knee Length (cm)	58.5	58.3	58.9	57.5
Heel Thickness (cm)	3.5	3.5	4.1	4.4
Detent	4.8	4.7	7.5	6.1
Bolt to Heel (cm)	50.8	46.3	40.9	43.9
Foot Pitch (Deg to Horiz)	55.0	63.1	54.1	58.0
Foot Rotation (Deg to Vert)	9.9	12.5	10.6	10.2

TABLE 3.4(c): MEAN VALUES OF PHASE I MEASUREMENTS FOR THE SIXTEEN SUBJECT GROUP/VEHICLE CATEGORIES

Measurement by Group	Malibu	Citation	Escort	Champ
Small Female:	(N=11)	(N=10)	(N=10)	(N=10)
Age (years)	43.2	36.0	32.3	31.8
Stature (cm)	151.7	152.6	150.9	151.4
Weight (kg)	47.4	46.9	47.5	47.3
Erect Sitting Height (cm)	82.2	81.4	81.4	82.1
Buttock Knee Length (cm)	52.9	53.3	52.6	51.9
Heel Thickness (cm)	3.9	4.3	4.9	5.2
Detent	1.4	1.3	1.4	2.9
Bolt to Heel (cm)	50.9	46.4	41.0	43.8
Foot Pitch (Deg to Horiz)	53.2	62.3	55.1	57.3
Foot Rotation (Deg to Vert)	6.1	9.8	6.0	6.8
Mid-Sized Female:	(N=10)	(N=12)	(N=14)	(N=14)
Age (years)	42.3	41.6	37.6	40.4
Stature (cm)	162.5	162.2	163.6	162.5
Weight (kg)	62.4	62.9	64.1	63.1
Erect Sitting Height (cm)	86.6	86.0	87.8	86.2
Buttock Knee Length (cm)	57.3	55.9	57.2	57.3
Heel Thickness (cm)	3.7	3.7	4.5	5.5
Detent	3.6	3.3	5.6	5.4
Bolt to Heel (cm)	52.1	47.5	42.0	44.8
Foot Pitch (Deg to Horiz)	57.5	63.9	53.1	58.4
Foot Rotation (Deg to Vert)	6.8	8.4	5.5	7.5
Mid-Sized Male:	(N=15)	(N=14)	(N=13)	(N=11)
Age (years)	39.3	35.7	35.9	32.9
Stature (cm)	175.1	174.5	175.0	174.1
Weight (kg)	78.3	77.2	77.3	76.8
Erect Sitting Height (cm)	92.2	91.3	92.1	92.2
Buttock Knee Length (cm)	60.1	60.4	61.0	59.0
Heel Thickness (cm)	3.1	3.4	3.5	2.9
Detent	6.5	6.3	9.9	7.4
Bolt to Heel (cm)	49.5	46.7	40.5	42.5
Foot Pitch (Deg to Horiz)	55.6	65.8	55.2	59.5
Foot Rotation (Deg to Vert)	9.3	15.8	13.7	9.4
Large Male:	(N= 8)	(N= 8)	(N=10)	(N=17)
Age (years)	35.1	36.6	31.4	33.9
Stature (cm)	186.4	184.9	186.5	186.6
Weight (kg)	102.7	103.0	101.6	99.8
Erect Sitting Height (cm)	97.0	96.1	97.0	97.4
Buttock Knee Length (cm)	64.7	64.5	64.6	63.8
Heel Thickness (cm)	3.3	2.8	3.5	2.9
Detent	8.0	8.5	13.0	10.0
Bolt to Heel (cm)	51.5	43.9	39.6	44.3
Foot Pitch (Deg to Horiz)	53.5	58.1	52.8	56.1
Foot Rotation (Deg to Vert)	20.1	14.2	18.4	21.9

to the seat-track mounting bolt before proceeding with the H-point procedure. Assistance was received from experienced personnel at Ford Motor Company until confidence in the proper use of this device was achieved. Figure 3-5 illustrates use of the H-point machine following the protocol listed in Table B.5. Table B.6 compares the seat buck H-point measurements with the H-point design specifications for each vehicle. The measured and desired results are generally in excellent agreement and all seat buck specifications are within allowable tolerance according to automotive company engineers.

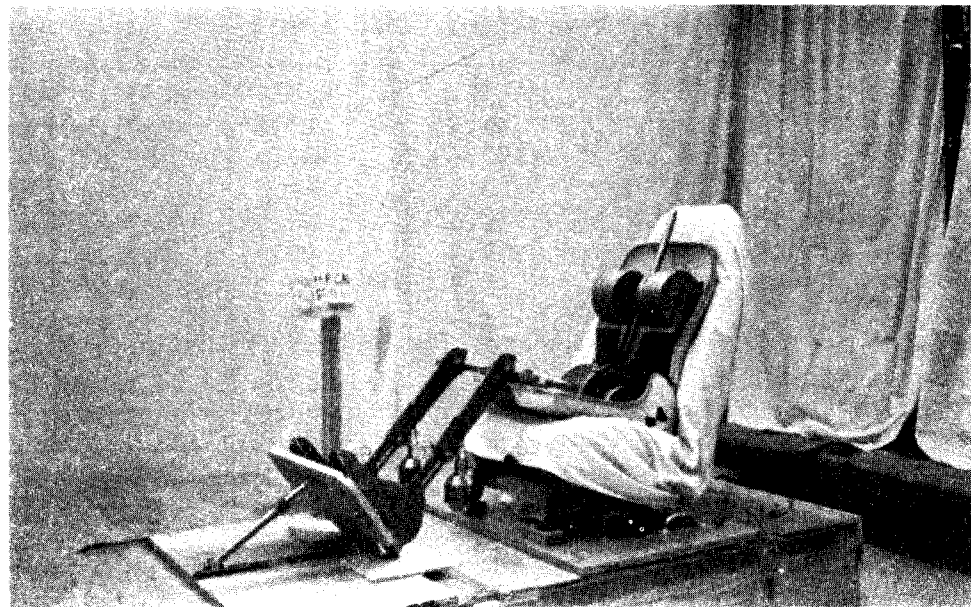


FIGURE 3-5. J826 H-point machine validation of vehicle seat bucks.

3.5.2 Simulation of Driver Configurations. With seats correctly oriented per vehicle package dimensions and H-point specifications, subject and seat position data taken in the vehicles during Phase I testing were used to determine seat-track detent position and toeboard location and tilt for each subject-group/vehicle-type combination. Appendix C contains illustrations and tabulations of measured and calculated values involved and describes the buck development process in detail. Figure 3-6 illustrates some of the basic features and reference points of these vehicle bucks and Table 3.5 gives the final buck dimensions.

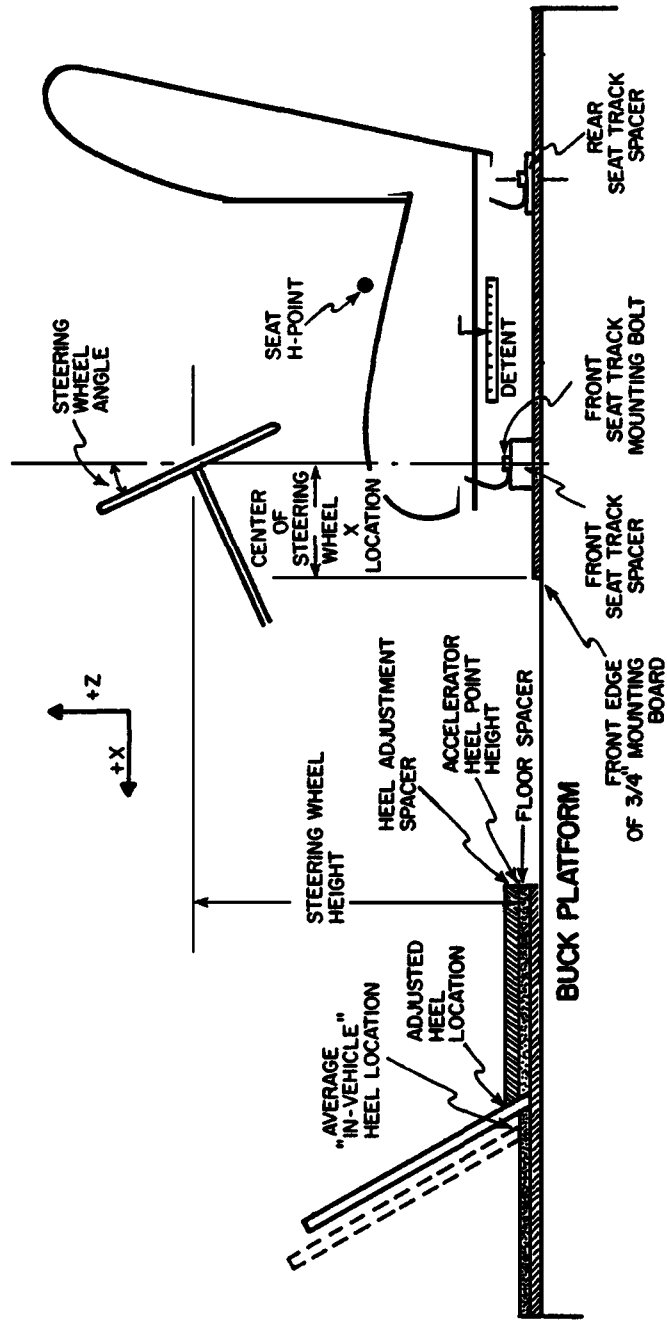


FIGURE 3-6. Features of vehicle seat buck used for Phase II measurements.

Since foot pitch and rotation angles were similar across all subject/vehicle conditions, the averages of all subjects were used (58 degrees pitch and 11 degrees rotation). Seat-track detent values were averaged for each of the sixteen possible situations (four subject groups times four vehicles) and rounded off to the nearest integer values. To account for round-off error, correction factors were applied to the measured heel locations (HEELLOC in Table C.1). Heel positions relative to the front seat mounting bolts were determined by applying a second set of correction factors to the average measured heel locations (HEELLOC) in the vehicles. These correction factors were calculated from shoe heel thickness (subjects were barefoot in the buck) and foot pitch angle measurements and are illustrated in Figure C-2 of Appendix C. The heights of the heel positions were also adjusted for these shoe heel thickness factors. As indicated in Table 3.5, all resulting buck dimensions, except seat detent settings, were vehicle specific and independent of subject group. Table 3.6 shows the detent settings used for each of the group/vehicle conditions. Figure 3-7 shows the completed seat buck with the Malibu seat, steering wheel, and toeboard for Phase II subject testing.

3.6 Phase II Testing: Measurement of Seated Posture and Seat/Subject Interface Contours

As previously stated, there were two purposes to Phase II subject testing. First, it was important to define seated posture in vehicle (soft) seats for eventual comparison with, and validation of, seated position and posture in the contoured hardseats (see Section 3.9). Second, it was necessary to determine the seat/subject interface contours that would define the contoured hardseats for each group. The first objective was accomplished by using stereophotogrammetry to locate the three-dimensional coordinates of markers placed on the skin over palpated skeletal landmarks. Accomplishment of the second objective involved casting the seat/subject interface using a medical splint casting material known as Scotchcast. The following sections describe these procedures and results in some detail.

TABLE 3.5
FINAL VEHICLE SEAT BUCK DIMENSIONS*

Vehicle	TOEBOARD PITCH: HORIZ. (Deg)	FOOT ROTATION: VERTICAL (Deg)	BOLT TO HEEL DIST (In)	HEEL SPACER (In)	HEEL DISTANCE from C/L (In)	WHEEL HT (In)	WHEEL TILT (Deg)
Malibu	58	11	19.3	1.50	3.9	25.0	21
Citation	58	11	17.2	.75	3.9	25.0	21
Escort	58	11	14.8	1.25	3.9	25.0	26
Champ	58	11	16.2	1.50	3.9	25.0	26

*See Table C.1 for definition of variables.

TABLE 3.6
BUCK SEAT DETENT SETTINGS

Group	Malibu	Citation	Escort	Champ
Small Female	1	1	1	2
Mid-Sized Female	3	3	6	5
Mid-Sized Male	6	6	10	7
Large Male	8	8	13	10

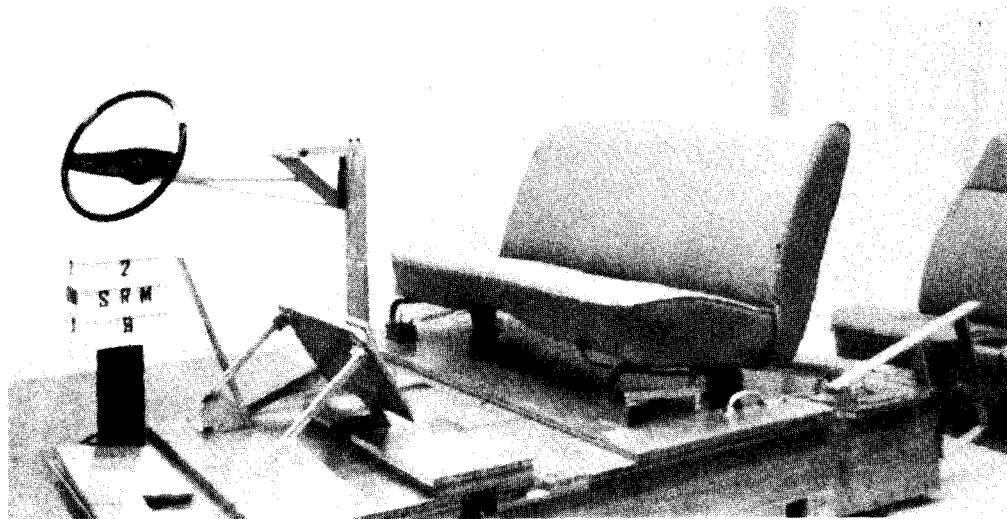


FIGURE 3-7. Phase II measurement buck with Malibu seat, toeboard, and steering wheel swung out of position.

3.6.1 Stereophotogrammetry Data Collection System. The task of determining the three-dimensional coordinates of surface markers on each subject in both Phase II and Phase III testing was accomplished by means of a stereophotogrammetric system illustrated schematically in Figure 3-8. Seven 35-mm Pentax cameras were positioned and fixed in the laboratory to view the seat buck from the upper front (camera no.1=UF), lower front (camera no.2=LF), left side (camera no.3=LS), right side (camera no.4=RS), lower back (camera no.5=LB), upper back (camera no.6=UB), and upper side (camera no.7=US). The technique used to determine X, Y, and Z laboratory coordinates of targets viewed by at least two cameras involves the mathematical approach known as direct linear transformation (DLT) described by Alem et al. (1978) and Abdel-Aziz and Karara (1971). Calibration coefficients for a set of equations that relate camera image coordinates (U,V) to spatial coordinates (X, Y, and Z) are determined by photographing a three-dimensional grid of targets whose coordinates relative to each other are precisely known. The "field of view" is thereby calibrated for any target placed within the calibrated volume, without the need for precise measurement of camera orientations and distances, and remains calibrated as long as the cameras are not moved.

Figure 3-9 shows the target array used to establish the DLT calibration coefficients for the laboratory space occupied by subjects seated on the buck platform. A series of colored spherical beads were placed at precisely measured intervals along model aircraft cables. The cables were suspended from a steel structure using a matrix of precisely positioned holes and were tensioned with plumb weights. Locations of points in three-dimensional space determined by this setup are given in X_L , Y_L , and Z_L coordinates with positive X_L facing forward on the buck, positive Y_L toward the subject's left, and positive Z_L upward. Cameras were loaded with Ektachrome 200 35-mm slide film. During subject testing, the shutter release knobs on all cameras were fired simultaneously by means of air-pressure activated solenoids that were manually operated by a central hand pump. In Phase II testing, the rear cameras (nos. 5 and 6) were not used since there were no spinal targets.

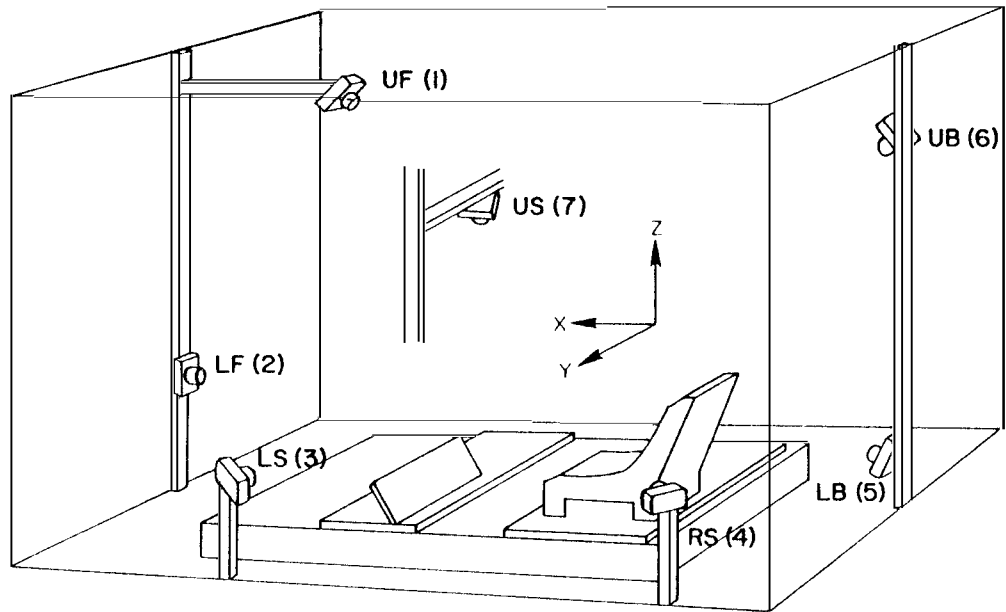


FIGURE 3-8. Schematic drawing of seven camera stereophotogrammetry system.

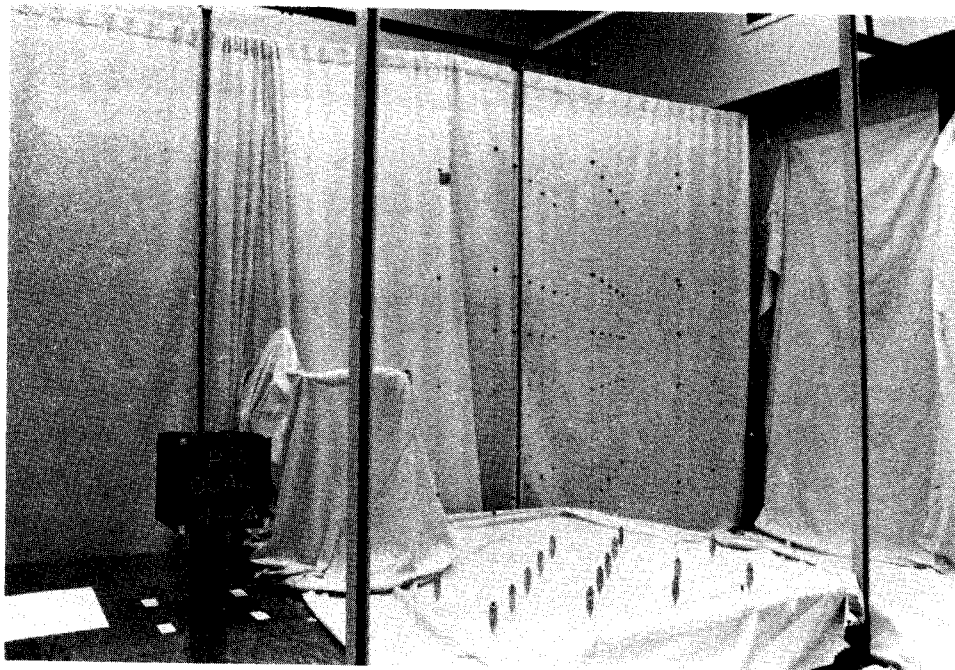


FIGURE 3-9. Target array for calibration of seven-camera stereophotogrammetry system.

3.6.2 Phase II Protocol: Seated Posture. Prior to arrival of a subject for Phase II testing, the buck platform was configured with the vehicle seat assembly and toeboard location for the vehicle the subject had been assigned to in Phase I. Upon arrival at UMTRI, subjects were reweighed to ensure they still met the criteria of their assigned group. They were then instructed to change into brief, light-colored under attire (underbriefs for the men, underbriefs plus halter for the women), and to sit in the vehicle seat in the standardized, relaxed driving posture, as illustrated in Figure 3.10, with hands symmetrically on the steering wheel at the 10 o'clock and 2'clock positions, and the feet placed squarely and symmetrically on the toeboard at the established heel positions and angles.

Table 3.7 lists the surface landmarks targeted for Phase II testing. Definition of these terms can be found in Appendix D. With the subject in the seated position, the first seven skeletal landmarks were palpated on the subject's left side and targeted with contrast markers. The subject was instructed to relax, look straight ahead at an appropriately positioned target, and to remain still when ready. The five cameras were then fired simultaneously to record the locations of the surface targets at this position and posture.

After checking and winding all cameras, the steering wheel was removed and the subject was asked to hold two 1/4-inch diameter metal probes with tips placed on skin surface points palpated over the left anterior-superior iliac spine (ASIS) and pubic symphysis as shown in Figure 3-11. These palpated points are needed to estimate the orientation of the seated pelvic bone, but are difficult or impossible to "see" with the cameras due to their locations and/or excessive tissue in these areas. Use of the probes not only provided a means of photogrammetrically locating the surface points, but also allowed a closer approximation to the actual skeletal landmarks of interest by having the subjects compress the tissue with the probes prior to shuttering the cameras. Each probe was provided with three contrast rings (targets) located known distances from the tip and from each other. The coordinates of each probe tip were determined analytically by constructing the vector with the least squared-error fit to the three



FIGURE 3-10. Mid-sized male seated in Malibu seat on buck.

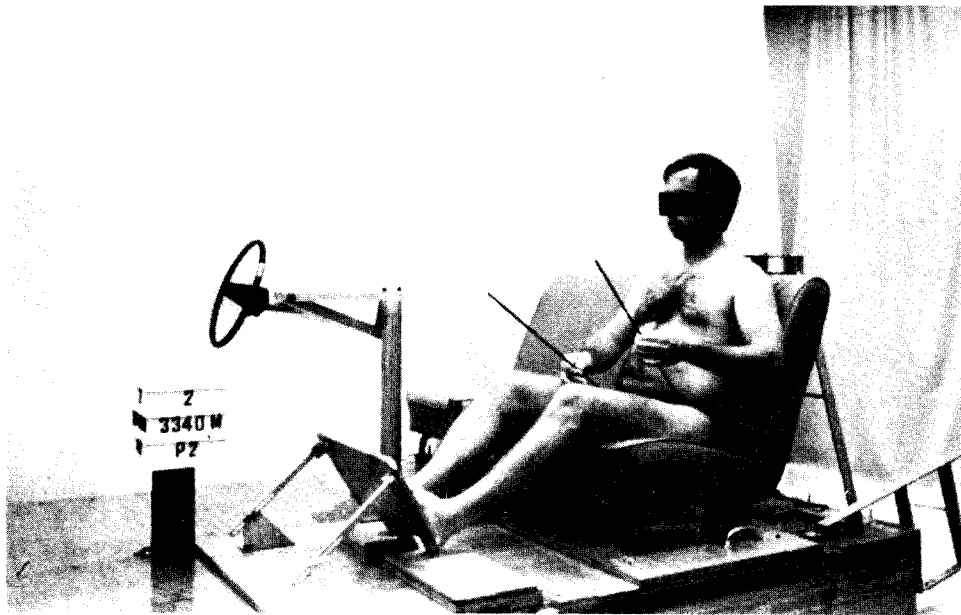


FIGURE 3-11. Mid-sized male holding probes on pelvic landmarks.

TABLE 3.7

PHASE II SURFACE LANDMARKS FOR PHOTOGRAMMETRY

Contrast Markers:

Infraorbitale

Tragion

Suprasternale

Acromion

Trochanterion

Lateral Femoral Condyle

Lateral Malleolus

Probes:

Anterior-Superior Iliac Spine

Pubic Symphysis

ring targets and extrapolating the known distance along this vector to the tip.

3.6.3 Phase II Protocol: Seat Casting. The second part of Phase II testing involved determining the seat/subject interface contours. A number of different approaches to this problem were considered, but a casting procedure was determined to be the most feasible and was greatly facilitated by discovery of a relatively new material called Scotchcast, produced by the 3M Corporation. Although quite costly, sufficient material was made available at no cost by the Surgical Products Division of 3M Corporation in St. Paul, Minnesota. This material is essentially a resin-impregnated cloth that hardens to a rigid structure in about ten minutes when exposed to moisture.

Figure 3-12 illustrates how strips of Scotchcast were placed over the vehicle seats and sandwiched between thin plastic liners prior to the subjects lowering into the seated position by using a supporting grab bar. In order to ensure good contact of the seat casting material with the subject in the region of the seat-back/seat-cushion interface, the Scotchcast strips were suspended across this region and allowed to be pushed into place by the subject's body. After the subject was seated, the steering wheel was swung into place and instructions were given to assume the standardized, relaxed driving posture within the constraints previously defined. Minor adjustments in seated position

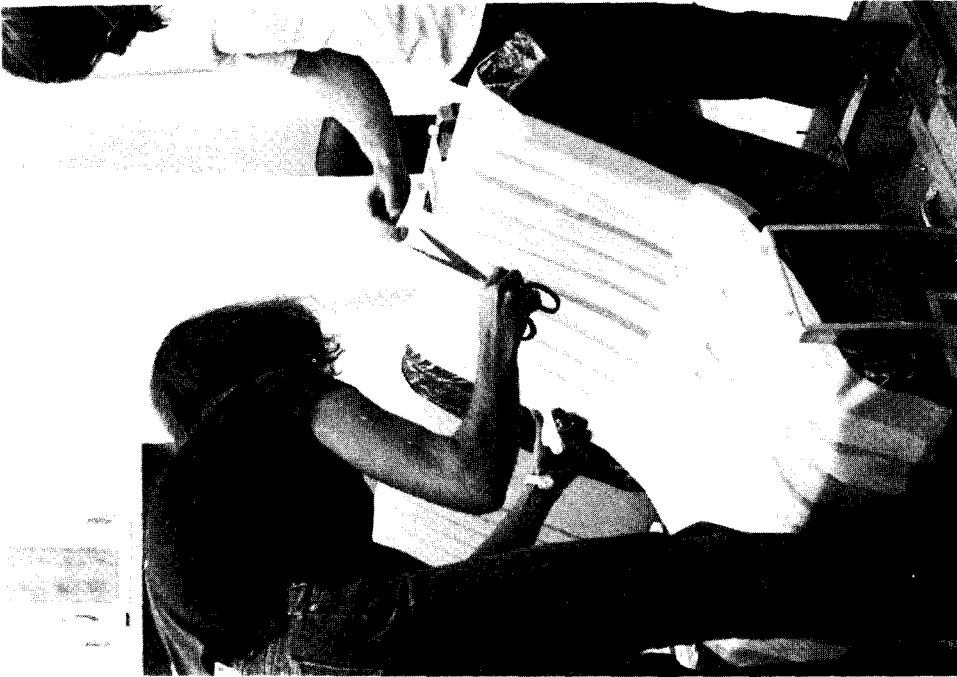
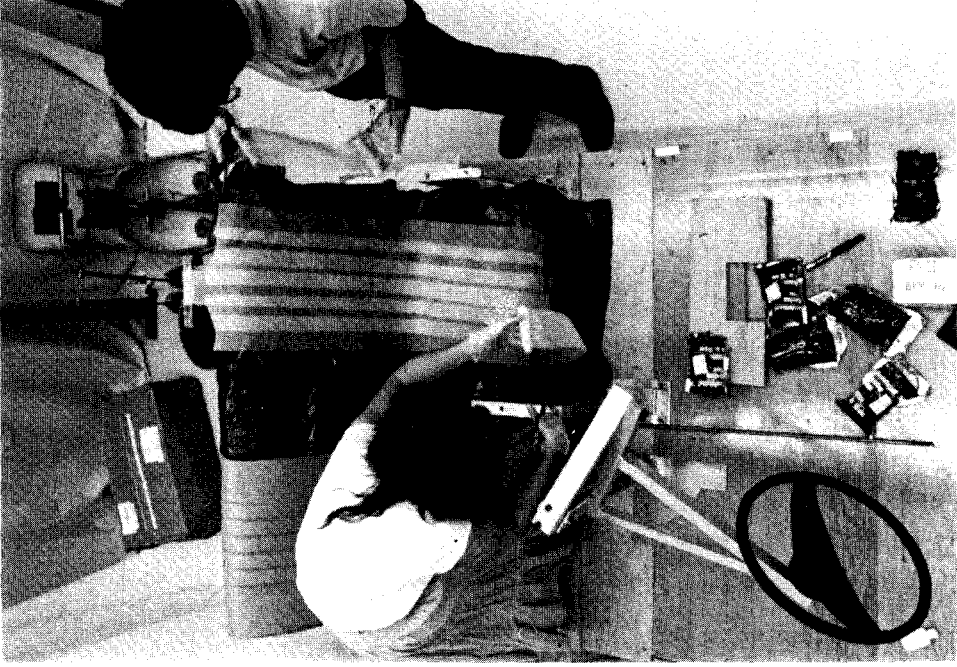


FIGURE 3-12. Placing Scotchcast on vehicle seat.

were allowed, but generally the subjects considered their initial position appropriate and similar to their position without the casting material.

As shown in Figure 3-13, before the Scotchcast material hardened, it was bolted to three aluminum frame supports by metal tabs that were pop riveted to the Scotchcast. These tabs and supports provided a means for relocating the casting in its original position after the subject and seat were removed. Also, while the material was setting up, three more sets of photographs were taken to document the subject's position and posture in the seat casting. The first set of photographs, with the subject's hands on the steering wheel, provided information on location of the first seven surface landmarks listed in Table 3.7. The second and third sets of photographs were with the subject holding the pelvic probes. First, the subject held one probe on the left anterior-superior iliac spine (ASIS) and the other probe on pelvic crest. Next, the subject held the two probes on the right and left ASIS. The purpose of this latter set of photographs was to determine the centerline of the seat casting along the Y_L axis. This information was needed to properly merge the seat casting contours from different subjects and vehicle seats.

Upon completion of this final set of photographs and after the seat casting material was sufficiently rigid (ten to fifteen minutes), the subject/seat separation line was sketched on the casting material with a pencil and the metal tabs were unbolted from the frame supports. The subject was then assisted to a standing position while the seat casting was lifted by a second investigator to prevent the undepressed seat cushion from distorting its shape. While the subject was dressing, the vehicle seat was removed and the seat casting was placed back in position by rebolting the metal tabs to the frame members as illustrated in Figure 3-14. Rows of contrast dots were then placed across the seat casting and also along the subject outline. Using the upper front, lower front, and upper side cameras (camera nos. 1, 2, and 7, respectively) a final set of photographs was taken to document the location of these dots, and thereby digitize the seat/subject interface contour in laboratory coordinates.

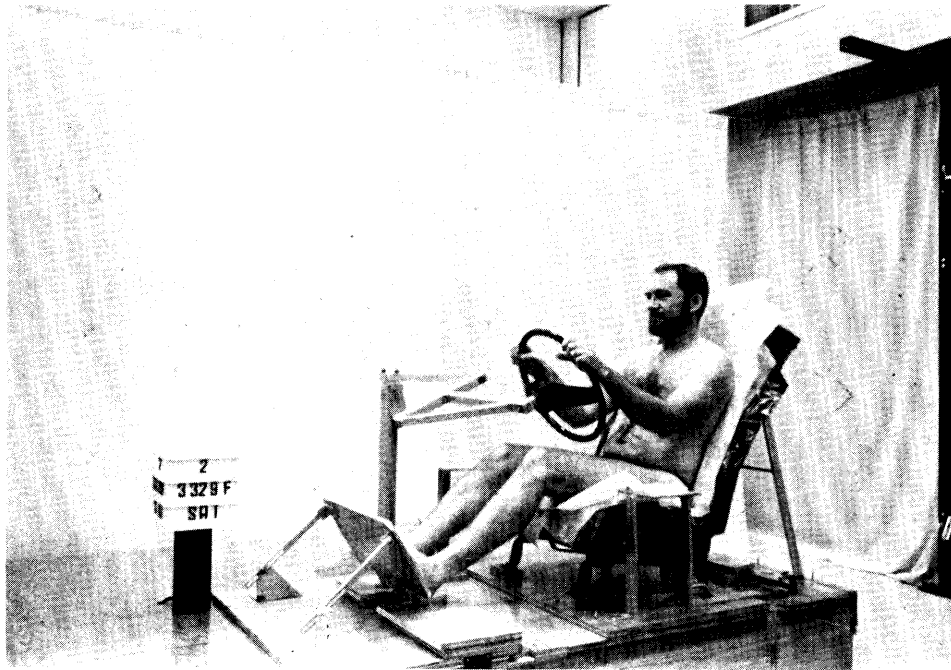


FIGURE 3-13. Mid-sized male seated in Scotchcast on vehicle seat. Scotchcast is attached to aluminum frame before it hardens.

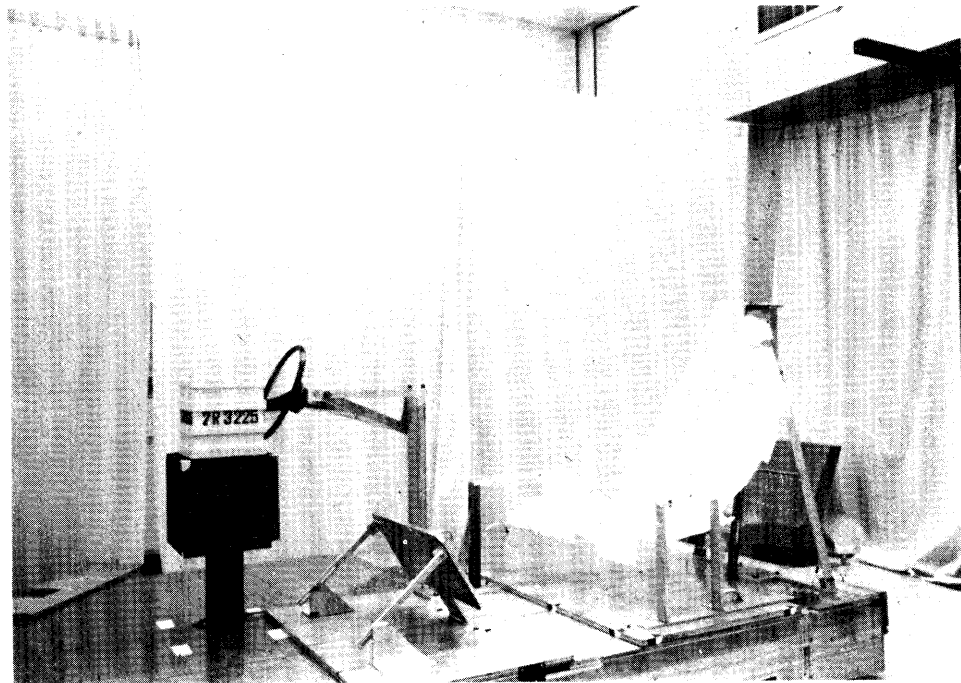
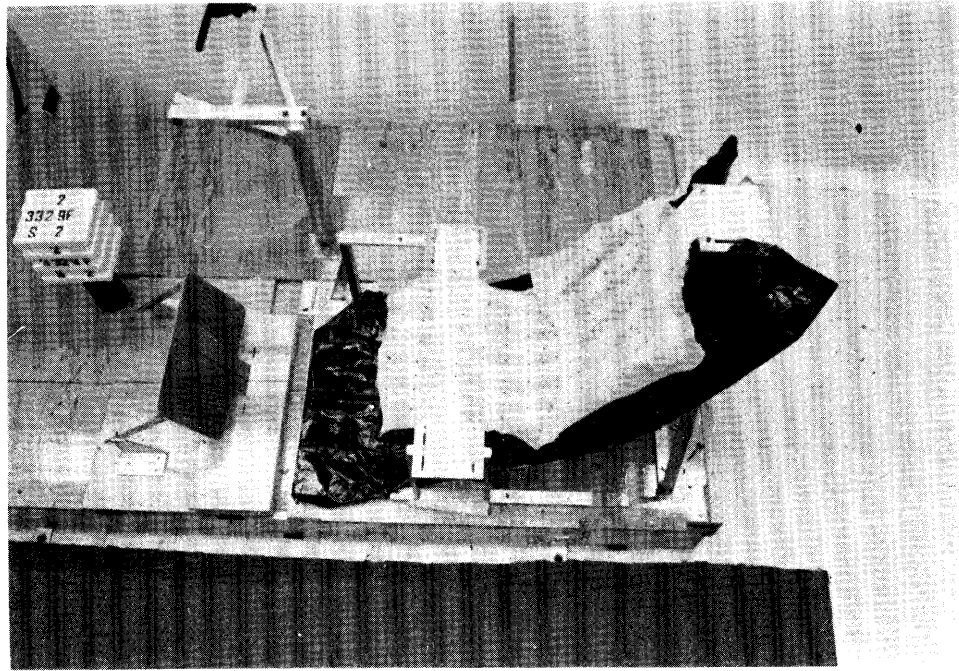


FIGURE 3-14. Seat Casting fastened back in frame support after removal of vehicle seat. Rows of contrast dots were placed on the casting surface to digitize the contour.

3.6.4 Phase II Sampling Strategy. Prior to Phase II data collection and analysis, it was not known how many subjects would be required to define the standard hardseat for each group, or even if the castings made from the different vehicles could be merged in any reasonable way. A pilot study was therefore conducted in which the same subject (a mid-sized female) made castings in the four different seats. These seat castings were photographed and digitized and the data were processed by procedures described in the next section. As illustrated in Figure 3-15, a graphical comparison of the unshifted $X_L Z_L$ plane midline contours for these four seat castings gave preliminary confidence to the technique and to the ability to average the data across vehicle seats.

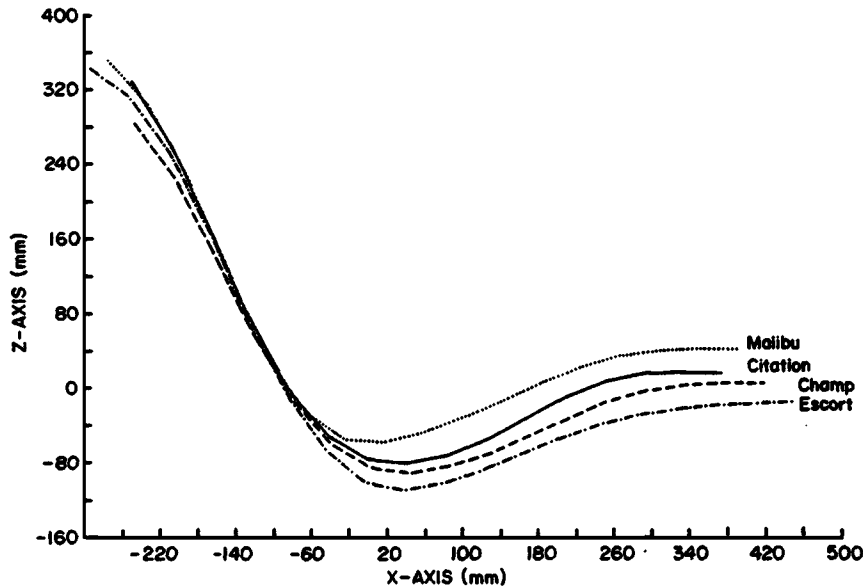


FIGURE 3-15. Comparison of midline contours from seat castings of a mid-sized female sitting in the four vehicle seats.

It was also clear by this time that the effort required to make a seat casting, digitize, and process the data would not permit the use of a large number of subjects in Phase II testing. It was therefore decided that eight subjects would be used for each subject group, two per group in each vehicle seat. The need for additional subjects would be determined after analysis and comparison of these initial results.

As it turned out, a visual and rather subjective evaluation of the midline contours from these eight subjects in each group indicated that little would be gained by adding more subjects (see Figures 3-16 and 3-17).

The eight subjects used in each group were selected at random from the full samples of subjects recruited in Phase I. Table 3.8 lists the mean values of age and Phase I anthropometric measurements for these Phase II subject samples, and the shaded blocks in the histograms of Figures D-1 through D-5 illustrate the distributions of these measurement values for those Phase II subjects who also participated in Phase III measurements.

TABLE 3.8
MEAN VALUES OF ANTHROPOMETRIC MEASUREMENTS
FOR SUBJECT SAMPLES USED IN PHASE II
(N=8 in each group)

Measurements	Small Females	Mid-Sized Females	Mid-Sized Males	Large Males
Age (yrs)	34.6	36.3	34.6	40.1
Stature (cm)	151.1	162.3	174.8	186.0
(in)	59.5	63.9	68.8	73.2
Weight (kg)	46.2	62.5	78.0	100.7
(lbs)	101.8	137.7	171.8	221.8
Erect Sitting Height (cm)	81.4	86.6	92.6	96.1
(in)	32.0	34.1	36.4	37.8
Buttock-Knee Length (cm)	52.7	56.9	59.6	64.1
(in)	20.7	22.4	23.5	25.2

3.6.5 Phase II Data Analysis. To determine X_L , Y_L , and Z_L coordinates for the nine surface landmarks (i.e., seven markers and two probes) in Phase II testing, the contrast targets in the films were digitized using the UMTRI Numographics Digitizer. Film plane (U,V) coordinates from each film frame in cameras 1, 2, 3, 4, and 7 were transmitted directly to computer files and later transformed into

laboratory X_L , Y_L , Z_L coordinates using DLT reconstruction programs modified for these data points. As previously described, coordinates for each of the probe tips were determined from the vector fitting the three target rings with the least squared-error.

In a similar manner, the rows of contrast dots placed on the castings were digitized from the upper front (#1), lower front (#2), and upper side (#7) cameras. A separate DLT program was used to reconstruct the three-dimensional coordinates of these dots that together define the shape and position (on the buck) of the seat/subject interface.

Since, in the process of establishing the vehicle seat bucks, the positions of the different vehicle seats were not aligned by any measures related to the seat geometries or seat casting contours, it was considered necessary to spatially merge the eight seat castings in each group prior to averaging. Several approaches to merging were considered, including:

1. Shift all seat castings appropriate X and Z distances to align the DESIGN H-POINTS of each seat translated to the appropriate detent for each subject group.
2. Shift all seat castings appropriate X and Z distances to align an ANATOMICAL POINT on each subject (e.g., trochanterion or iliac spine).
3. Shift all seat castings appropriate X and Z distances to align UNLOADED SEAT GEOMETRIES.

For the first procedure, merging on translated design H-points, results obtained by aligning four castings made by the same subject seated in the four different vehicle seats were found to produce inappropriate contour relationships between soft and firm seats.³ To decide which of the other two procedures to use, mid X-Z plane contours from the seat casting data for the eight subjects in each group were plotted for the two procedures. Since the geometries of the four seat types were different, it was impossible to align the contours exactly in procedure 3. Alignment was achieved by translations in the Z_L direction,

³The explanation for this is somewhat complicated but is due both to the fact that the distance from the H-point to the bottom of the J826 machine is fixed, and to the differences between the weight of the loaded H-point machine and subjects.

so that all unloaded seats had an equal maximum height for the seat cushion midline, and translations in the X_L direction so that the seat-back/seat-cushion intersection point (defined by a one-centimeter ball placed in the intersections) had equal X_L values. For both procedures, the seat contours were merged in the Y_L direction on the casting midline determined as the midpoint between each subject's iliac spines.

Figures 3-16 and 3-17 show the results for the mid-sized males. It can be seen that there are differences in the relationships of the contours for the two procedures and it is not obvious which is the best procedure. In the final analysis, it was found that the average curves resulting from the two approaches differed very little and merging on the average iliac spine coordinates for each subject group was chosen as the method to be used.

After the raw data points for each casting were shifted to merge iliac spines, SURF II, a three-dimensional plotting and gridding program developed at the University of Kansas, was used to display each casting contour. Plots were visually examined for discontinuities and edited for bad data points. The digitized data points, obtained from the rows of contrast dots placed manually on the castings, were interpolated using SURF II to provide Z_L values at desired X_L and Y_L coordinates common to all castings. The final symmetric hardseat contour was then defined by taking the simple average of Z_L values at each of these grid points utilizing the data from both sides of each casting (i.e., by averaging sixteen Z_L values at each grid point).

Figure 3-18 shows the midline $X_L Z_L$ plane cross sections of the average contours for the small female, mid-sized male, and large male, respectively. Figure 3-19 illustrates the three-dimensional plot produced by SURF II for the mid-sized male hardseat. Similar plots were generated for the average small female and large male seat contours. Analysis of the mid-sized female seat casting data was not completed due to a decision at this time to drop this member of the dummy family.

3.7 Fabrication of Contoured Hardseats

Development of the contoured hardseats for the three subject groups involved generating full-size plots of the average seat contours

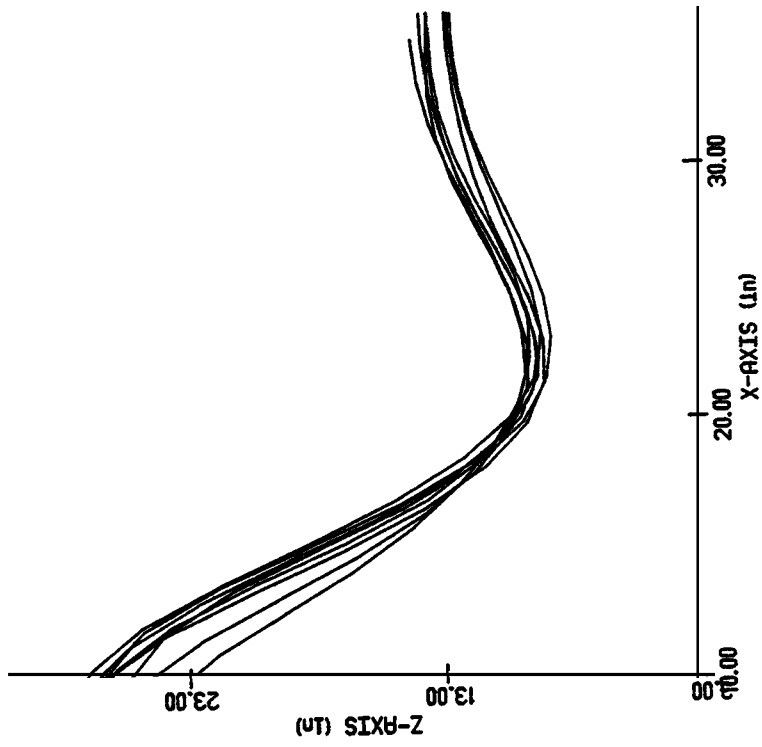


FIGURE 3-17. Midline contours from eight mid-sized male seat castings merged on iliac spines.

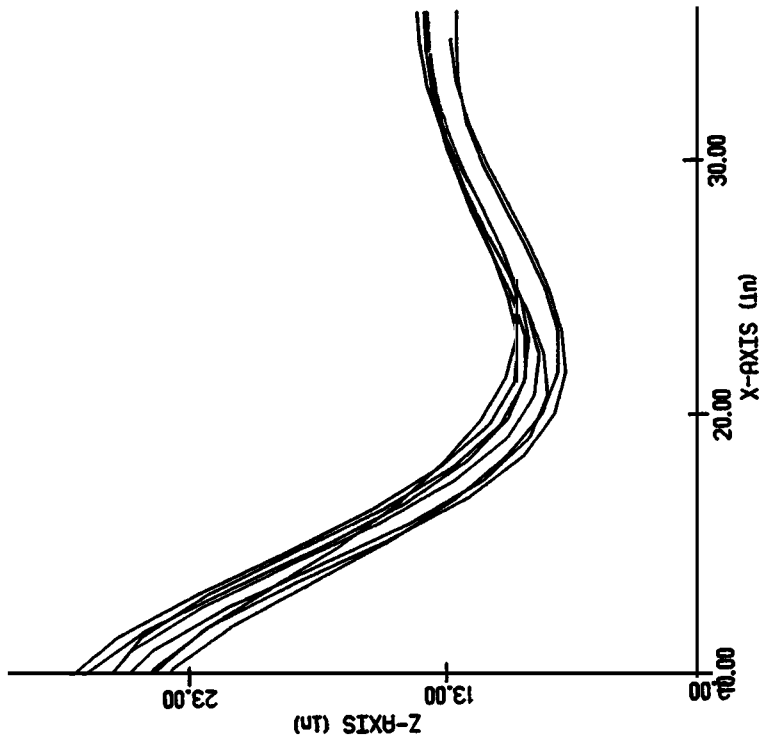


FIGURE 3-16. Midline contours for eight mid-sized male seat castings merged on unloaded seat geometry.

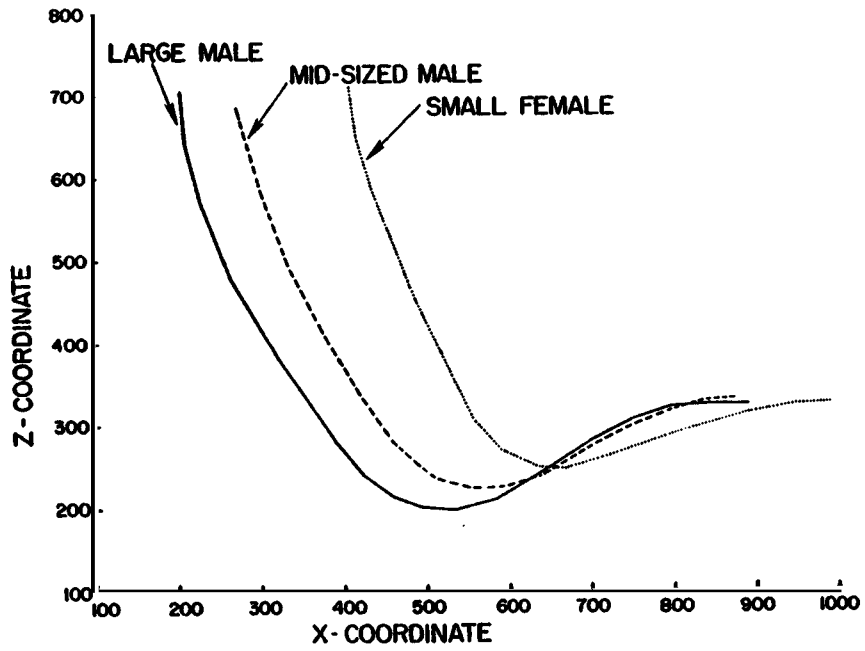


FIGURE 3-18. Midline $X_L Z_L$ plane cross-section contours for merged and averaged seat castings of the three subject groups.

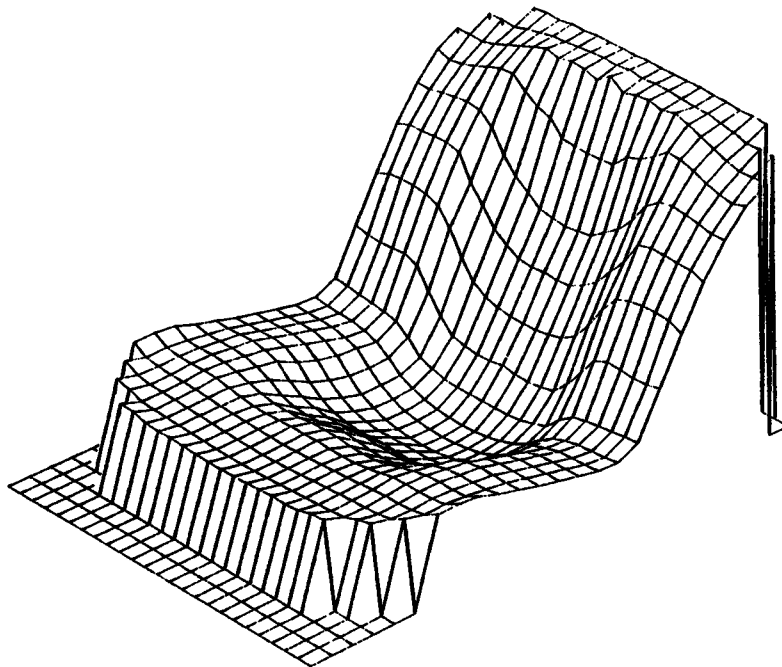


FIGURE 3-19. Three-dimensional plot for the mid-sized male hardseat contour.

for $X_L Z_L$ plane cross sections at the centerline and at increments of one inch from the centerline (in the Y_L direction) to a width greater than the average subject outline. Figure 3-20 shows the composite $X_L Z_L$ computer-generated plots for the small female hardseat. The plotting program generated a data point every 41.2 mm along the X_L axis and a smooth curve was "faired" between data points using architect curves. The smoothed cross sections were overlaid on a light table to ensure compatibility between cross sections at adjacent cuts. Full scale $X_L Y_L$ and $Y_L Z_L$ cross-section plots were then generated for the seat-cushion and seat-back region, respectively, from the set of $X_L Z_L$ cross-section curves. Lines defining the external features of the hardseats, such as the front vertical plane, seat-back thickness and shape, top of seat back, and legs, were drawn in and the completed sets of drawings were delivered to The University of Michigan Ship Hydrodynamic Model Shop for fabrication and carving of the actual seats.

In consultation with the sponsor, and after in-depth investigations into durability aspects and fabrication costs of various materials, a decision was made to use mahogany for construction of the contoured hardseats. This material was recommended as being superior to clear pine (the usual material for ship model-building) in terms of retention of properties and dimensional stability over time. "Perfect plank," a synthetic material used by the auto industry, is rated even better in these characteristics but was ruled out due to cost factors (about \$1,200 more per seat) and workability (i.e., it dulls tools quickly).

Figures 3-21 and 3-22 show the mid-sized male hardseat under construction. One-inch thick mahogany boards were cut to the approximate $X_L Z_L$ plane contours and laminated together. Cardboard templates of cross-section contours were made from the drawings and used to check the seat as carving progressed. Other cross-section templates from the $Y_L Z_L$ and $X_L Y_L$ plane drawings were used to check consistency in these planes during the carving process. The seat was constructed with a two-inch-wide, removable section down the center of the back to allow for viewing targets placed on the spinal processes of each subject.

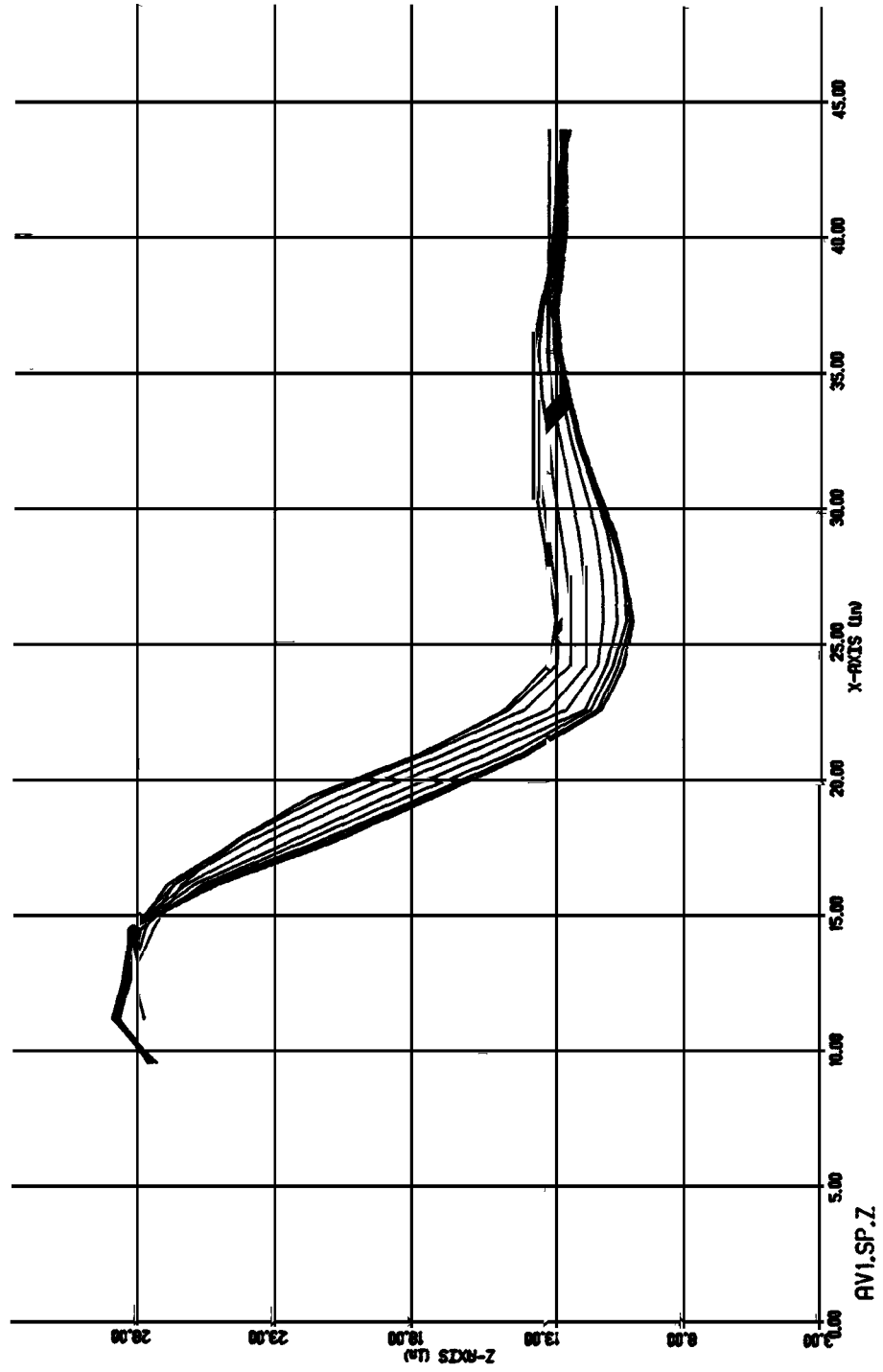


FIGURE 3-20. Composite of $X_L Z_L$ plane contours for the small female hardseat at the centerline and at one-inch intervals along the Y_L axis.

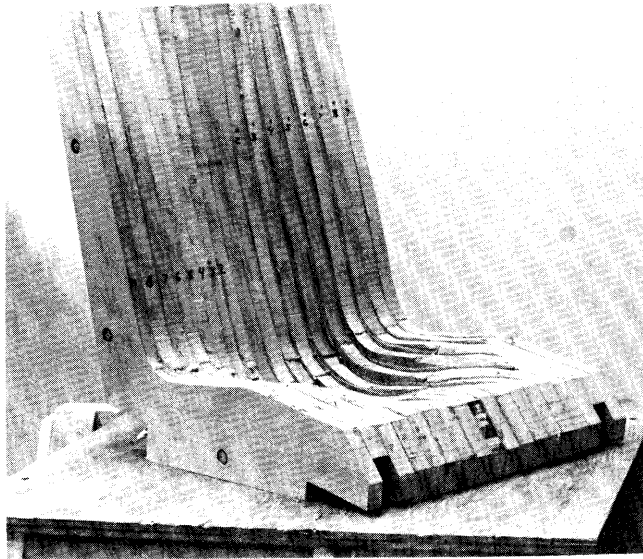


FIGURE 3-21. Early construction of the mid-sized male hardseat.

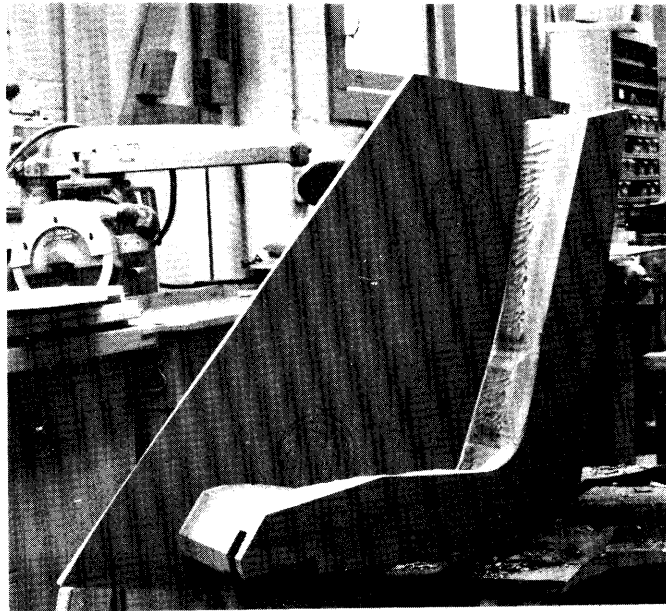


FIGURE 3-22. Later construction of the mid-sized male hardseat.

The completed hardseats were coated with a rubber-based gray paint to seal and protect the final product. They were then brought back to UMTRI where 1-1/4 inch aluminum spacers were attached to the legs to achieve the proper seat height on the buck platform. Each seat was attached to a 3/4-inch thick plywood board that had previously been used for mounting one of the vehicle seats (i.e., all hardseats were mounted to the same plywood board since Phase III testing of subjects was done sequentially by subject group).

The seat was positioned in the X_L direction using the front edge of the hardseat as a reference line so that the seat contours attained the same position in buck coordinates as specified by the drawings. For example, as shown in Figure 3-23, the front edges of the mid-sized male, small female, and large male seats were specified on the full-scale seat contour drawings at laboratory photogrammetry X coordinates of 914 mm (36 in.), 1041 mm (41 in.), and 889 mm (35 in.), respectively. The front edge of the 3/4-inch plywood mounting board was determined to have an X-coordinate value of 969 mm (38.1 in.). Thus to appropriately locate each hardseat contour on the buck platform, the front edge of the mid-sized male and large male hardseats were positioned approximately 55 mm (2.1 in.) and 80 mm (3.1 in.), respectively, behind the front edge of the plywood board, and the small female hardseat was positioned approximately 72 mm (2.8 in.) forward of (i.e., overhanging) the front edge of the mounting board.

The contours of each hardseat were also validated by using the $X_L Z_L$, $Y_L Z_L$, and $X_L Y_L$ plane templates used in the fabrication process. Each template was first compared with the drawing from which it was derived and then placed on the hardseat at the appropriate X_L , Y_L , or Z_L position and in the appropriate plane. Other dimensions, such as the distances from the bottoms of the legs to seat-back and seat-cushion top surfaces, were also checked with drawing specifications to ensure proper spatial orientation of these contours on the buck. To complete the hardseat buck setup, the toeboard X_L position and heel spacer height were adjusted to the averages of the four vehicle buck configurations. Figure 3-24 shows the final mid-sized male hardseat buck ready for Phase III testing.

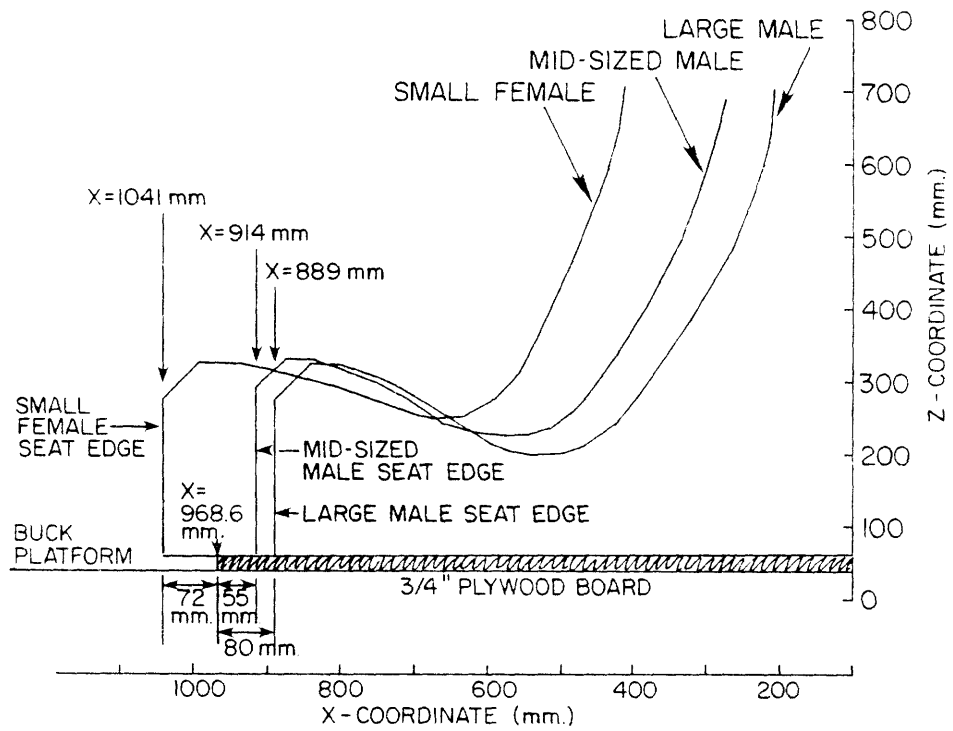


FIGURE 3-23. Placement of the three contoured hardseats on the buck relative to the front edge of the 3/4-inch plywood mounting board.

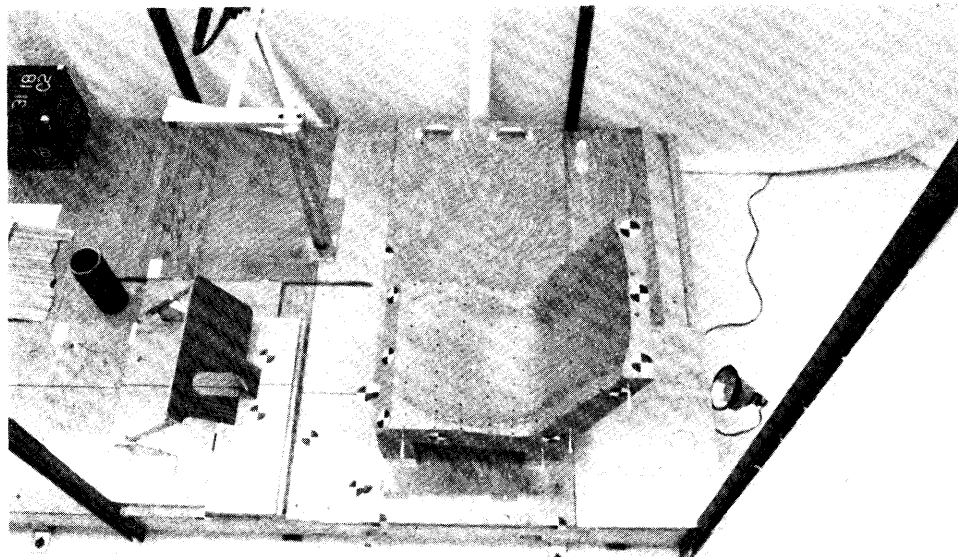


FIGURE 3-24. Hardseat buck for mid-sized males.

3.8 Phase III Testing: Standard Anthropometry and Hardseat Measurements

Phase I and Phase II measurement sessions provided the necessary data to establish the vehicle seat buck configuration and define the contoured hardseats. In Phase III testing, the final and complete set of anthropometric measures was taken for development of the anthropometric specification package and seated reference form for each dummy family member. This phase was divided into two separate sessions for practical reasons. In Session I subjects were measured for standard and traditional anthropometry in the standing or erect seated position. Session II involved measuring subjects seated in the hardseat bucks. The following subsections describe these procedures and results in detail.

3.8.1 Phase III Subject Samples. Out of the original sets of subjects recruited in Phase I, twenty-five were selected in each group for participation in the final measurement session. In determining this sample size, consideration was given to the need to represent the range of body proportions and seated position variability within each narrowly defined height and weight category and to represent age and race variability as described in Section 2. The overriding factors, however, were the limitation of time and funds for subject measurement and data processing.

Selection of subjects from the Phase I samples was based first on erect sitting height values. Since U.S. population sitting height results were not available from the HANES data at this time in the study, percentile values of sitting height for U.S. males and females were derived from "raw" HANES data made available to UMTRI from the School of Public Health at The University of Michigan. This preliminary analysis produced the sitting height percentile values shown in Table 3.9 from which 78.1, 90.1, and 96.6 centimeters were used as the target group means for the small females, mid-sized males, and large males, respectively. Race and age were considered as secondary selection factors, the goal being to have each subject group span the adult age range from 18 to 74 years and consist of approximately ten percent non-Caucasians.

TABLE 3.9

SITTING HEIGHT PERCENTILE VALUES (cm) FROM
ANALYSIS OF PRELIMINARY HANES DATA

Percentile	Male	Female
2.5	81.9	76.6
5.0	83.3	78.1
7.5	84.2	78.9
10.0	84.8	79.6
20.0	86.5	81.3
30.0	88.0	82.5
40.0	89.1	83.5
50.0	90.1	84.4
60.0	91.0	85.4
70.0	92.0	86.2
80.0	93.2	87.3
90.0	95.1	88.8
92.5	95.8	89.4
95.0	96.6	90.0
97.5	97.7	91.3

Figures 3-25 through 3-28 show the distributions of height, weight, sitting height, and buttock-knee length by subject group, while Figures D-1 through D-4 show these variable distributions in more detail and compare the sample mean values with the appropriate HANES percentile values. It is seen that, while the height and weight variables form distinctly separate distributions when the three groups are plotted on the same histogram, the distributions for sitting height and buttock-knee length are closer together and even show considerable overlap. Also, in general, the group means are very close to the HANES percentile values. For sitting height, the HANES percentile values were obtained from Johnson et al. (1981) and became available later in the study. For each group, the values are notably different than those in Table 3.9 determined from the analysis of preliminary data. The group mean values are reasonably close to these published HANES values, but could probably have been closer if these HANES data had been available at the time of Phase III subject selection.

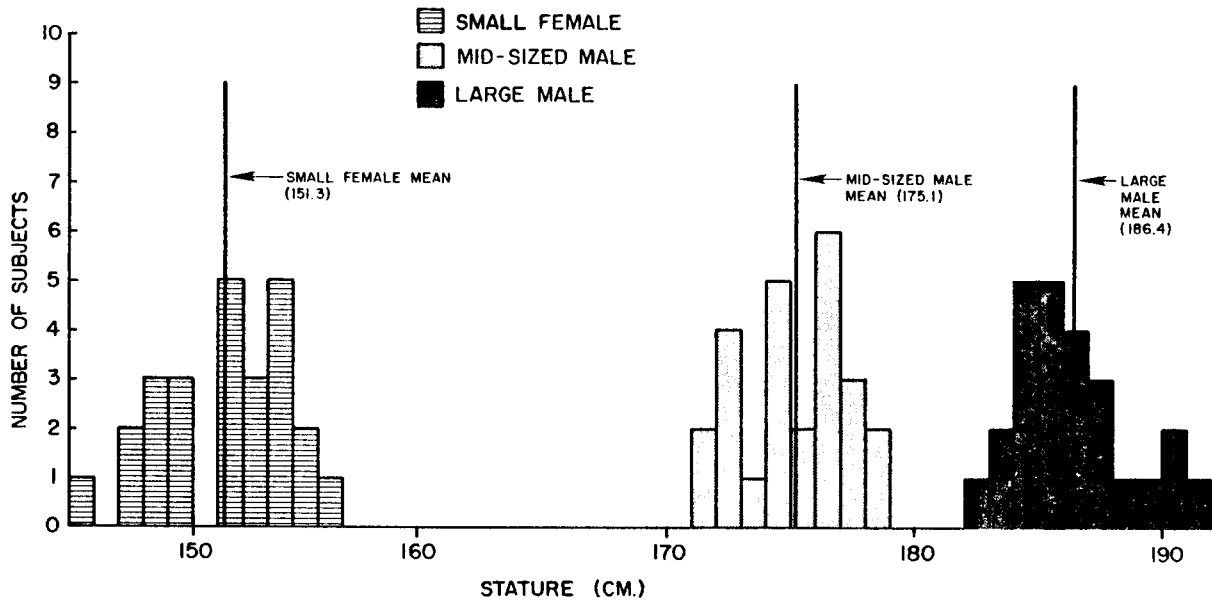


FIGURE 3-25. Distribution of stature for Phase III subjects.

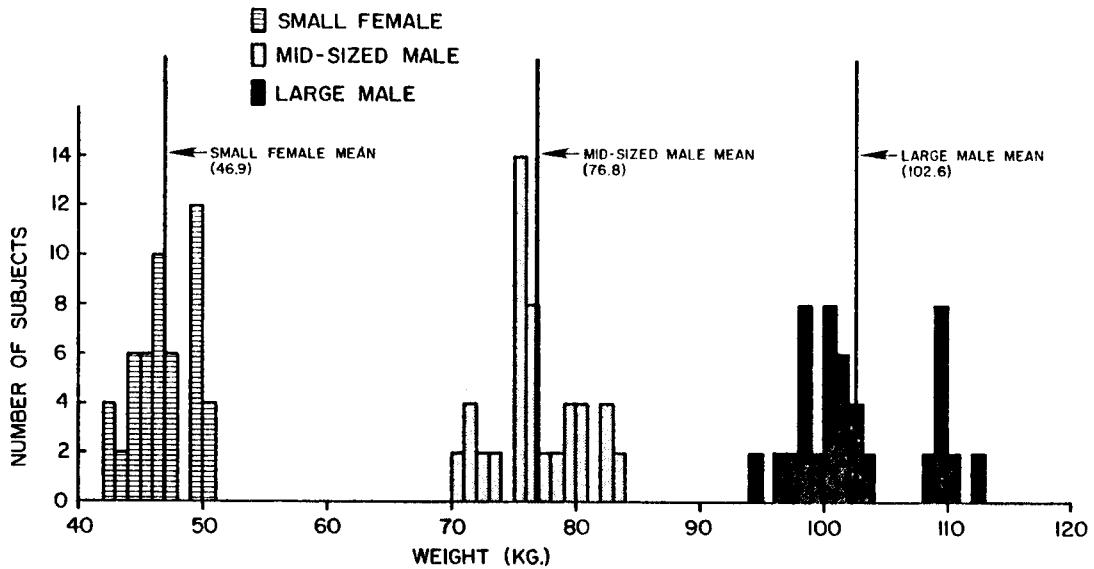


FIGURE 3-26. Distribution of weight for Phase III subjects.

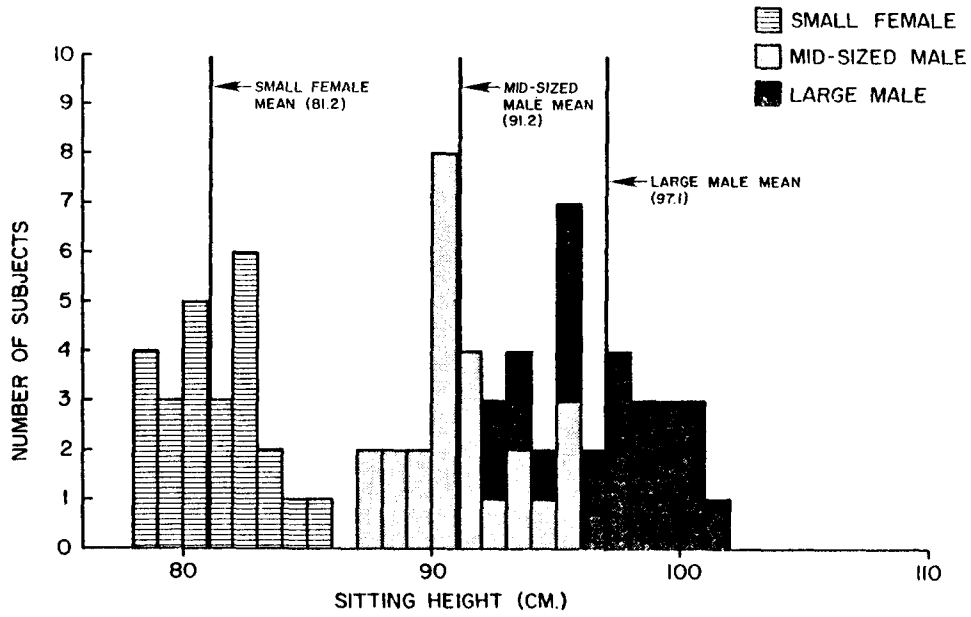


FIGURE 3-27. Distribution of erect sitting height for Phase III subjects.

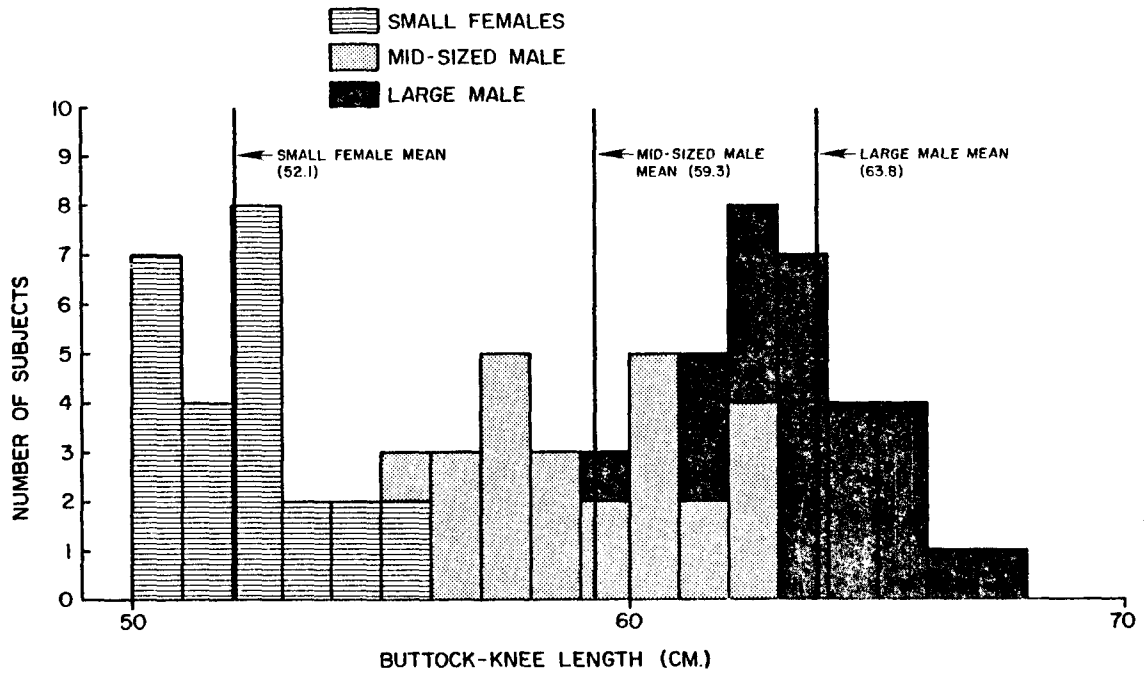


FIGURE 3-28. Distribution of buttock-knee length for Phase III subjects.

3.8.2 Standard Anthropometry. As a part of the process of establishing the subject groups for Phase III measurements, selected individuals were scheduled for the standard anthropometric measurements defined in Appendix E. This first set of Phase III measurements was to provide basic anthropometric data to compare the sample populations with other populations and to collect information about body linkage and long bone dimensions. The latter were used to select skeletal components for the armature of the mid-sized male clay model, a procedure that was abandoned for the small female and large male models. Measuring subjects for these standard anthropometric measurements also served the purpose of confirming subject availability and qualification so that the full sample of twenty-five subjects per group was established prior to the final measurement session in the contoured hardseats. Table 3.10 gives the mean values for the thirty-nine anthropometric measures taken in the standing or erect seated position. Tables 1.1, 1.4, and 1.7 give the summary statistics for each of these measures for the three subject groups.

3.8.3 Measurements in the Contoured Hardseats. The final and primary set of anthropometric data were taken with the subjects seated in the contoured hardseats developed from Phase II data. Data collected are divided into three categories which include:

1. SURFACE LANDMARKS - surface targets located by stereophotogrammetry,
2. SEATED ANTHROPOMETRY - measurements taken manually with subjects seated in the contoured hardseats, and
3. SURFACE CONTOURS - profiles of shoulder, knee, and thigh regions.

Appendix F contains photographs illustrating the collection of these three types of data.

Subjects were instructed to dress in brief attire, similar to that used in Phase II, and to sit in the contoured hardseat in the standardized normal driving posture with hands on the buck steering wheel at the 10 o'clock and 2 o'clock positions, and the feet placed firmly and symmetrically against the toeboard at the appropriate angles.

TABLE 3.10
MEAN VALUES OF STANDARD ANTHROPOMETRY
(cm or as noted)

Measurement Variable	Small Female	Mid-Sized Male	Large Male
Age (years)	39.8	38.1	36.6
Stature	151.3	175.1	186.4
Weight (kg)	46.9	76.7	102.6
Sitting Height (erect)	81.2	91.1	97.1
Buttock-Knee Length	52.1	59.3	63.8
Cervicale Height	129.8	149.8	160.2
Trochanterion Height	71.8	90.5	95.6
Tibiale Height	41.0	48.3	54.1
Head Breadth	14.5	15.8	15.6
Head Length	18.3	19.7	20.2
Head Height	20.0	23.1	23.3
Shoulder Breadth	38.1	44.9	48.2
Biacromial Breadth	34.2	39.5	42.3
Clavicale Length	15.7	18.3	20.7
Suprasternale-Cerv. Dist	10.2	12.6	14.3
Bispinous Breadth	20.6	22.5	25.2
Acromion-Radiale Length	27.6	32.9	35.5
Shoulder-Elbow Length	30.5	36.5	38.2
Elbow-Hand Length	40.0	47.4	50.2
Radius Length	22.5	26.9	28.6
Hand Breadth	7.2	8.5	9.0
Hand Length	16.2	18.7	19.7
Troc.-to-Lat. Fem. Condyle	32.9	43.5	46.8
Tibia Length	34.6	40.2	45.2
Foot Breadth	8.6	9.6	10.7
Foot Length	22.1	26.4	28.2
Head Circumference	53.4	57.1	59.4
Shoulder Circumference	92.5	111.5	126.4
Chest Circumference (axilla)	79.2	97.3	108.0
Chest Circumference (nipple)	80.9	96.1	109.8
Waist Circumference	66.0	85.9	103.3
Hip Circumference	87.8	94.4	105.7
Upper Arm Circumference (biceps)	25.0	29.9	32.7
Forearm Circumference	20.9	25.4	28.2
Thigh Circumference (mid)	48.0	51.5	55.7
Calf Circumference	31.8	36.7	40.4
Skinfold, Subscapular (mm)	11.9	15.1	26.6
Skinfold, Triceps (mm)	15.1	10.0	16.3
Skinfold, Suprailiac (mm)	19.5	21.1	33.9
Skinfold, Posterior Mid-Calf (mm)	12.2	9.9	16.7

As illustrated in Figure 3-29, contrast markers were placed on the skin for photogrammetric identification of important surface landmarks. Table 3.11 lists the full set of surface landmarks for the hardseat measurement session along with reference numbers.

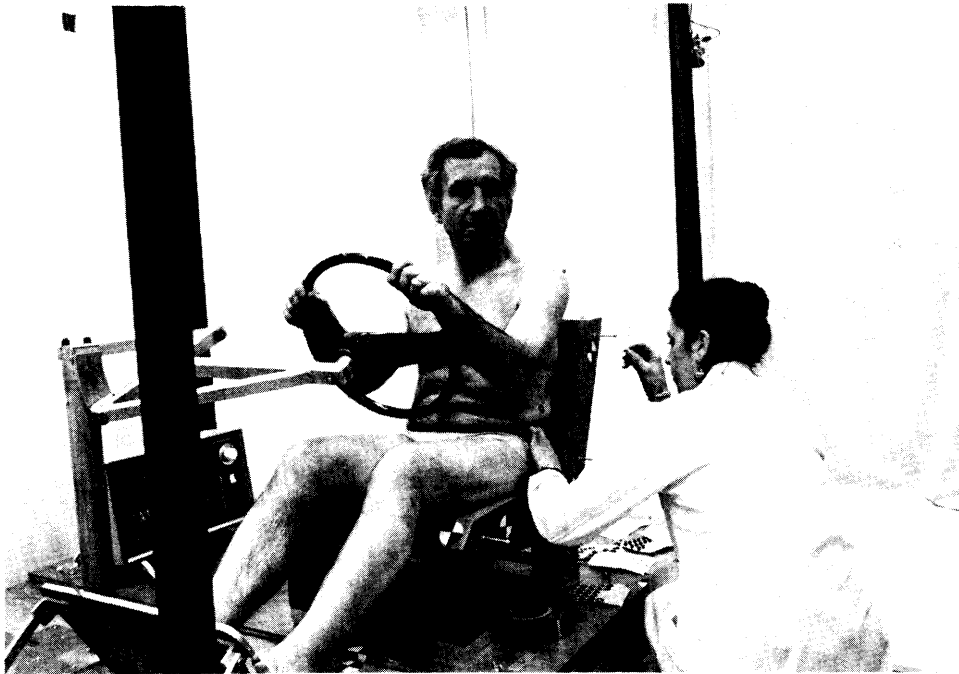


FIGURE 3-29. Contrast targets being placed at surface landmarks on seated subject.

Most targets denote surface palpations of skeletal landmarks required to determine body segment coordinate systems, locations of joint centers, and general body posture. Other targets were placed at surface points considered useful for development of the clay models, such as thigh-abdominal junction, posterior scye, etc. The last set of landmarks listed (reference numbers 93-101) were targeted to denote locations on the extremities where breadths, depths, and circumferences were measured. As in Phase II, 1/4-inch-diameter rods were used to determine compressed-tissue surface landmarks overlying the anterior-superior iliac spines and pubic symphysis of the pelvis. Appendix G contains definitions of each of these surface landmarks.

TABLE 3.11
LIST OF SURFACE LANDMARKS

Body Region	Ref. No.	Landmark Name
Head and Neck	1	Glabella
	2	Infraorbitale
	3	Tragion
	4	Gonion
	5	Gnathion
Spine and Scapula	7	Cervicale (C7)
	8	T4
	9	T8
	10	T12
	11	L2
	12	L5
	13	10th Rib, Mid-Spine
	14	Scapula, Superior Margin
	15	Scapula, Inferior Margin
Chest and Torso	18	Suprasternale
	19	Mesosternale
	20	Substernale
	21	Bimammary Midline
	22	Nipple
	23	10th Rib, Anterior Midline
	24	Umbilicus
	25	Maximum Abdominal Protrusion
	26	10th Rib
Pelvis and Hip	27	Iliocristale
	28	Anterior-Superior Iliac Spine (ASIS)
	29	Symphysion (Pubic Symphysis)
	30	Thigh-Abdominal Junction
	31a	Trochanterion (palpated)
	31b	Trochanterion (reconstructed)*
Shoulder	33	Clavicale
	34	Acromio-Clavicular Articulation
	35	Greater Tubercle Humerus
	36	Acromion
	37	Scye, Anterior
	38	Scye, Posterior
Arm and Hand	39	Lateral Humeral Epicondyle
	40	Radiale
	41	Medial Humeral Epicondyle
	42	Olecranon
	43	Ulnar Styloid
	44	Stylian

TABLE 3.11
LIST OF SURFACE LANDMARKS (Continued)

Body Region	Ref. No.	Landmark Name
Leg and Foot	45	Lateral Femoral Condyle
	46	Medial Femoral Epicondyle
	47	Tibiale
	48	Patella
	49	Sphyrion
	50	Metatarsal/Phalangeal I
	51	Digit II
	52	Metatarsal/Phalangeal V
	53	Lateral Malleolus
Anthro. Measurement Points	93	Neck, Mid
	94	Neck, Lower
	95	Arm, Upper
	96	Forearm, Upper
	97	Forearm, Lower
	98	Thigh, Upper
	99	Thigh, Mid
	100	Calf
	101	Ankle

*See Section 3.10, Section 5.3, and Volume 2 of this report.

In order to distinguish between markers located near each other, each landmark was assigned a specific color combination of contrasting markers. For example, iliocristale was designated with a black dot on a larger yellow dot so that it could be distinguished from tenth rib which was designated with a yellow dot on a large black dot. For some landmarks, a colored spherical marker was flattened on one side and attached to the larger contrast dot so that the surface point could be located in the film plane of a camera oriented nearly perpendicular to the skin surface. Most landmarks were located with the subject in the seated position but for some, such as the spinal markers, the subject was required to lean forward so that the spinal processes could be easily palpated and counted.

Upon placement of all surface markers, the subject was again instructed to obtain the standardized normal driving posture. Twenty-two measurements were then taken to record the heights (from the

3/4-inch seat mounting board) of certain landmarks, arm and leg angles, and distances between arms and legs (see Figure 3-30). These measures are denoted as the pre-photo measurements in Table 3.12 and were taken immediately prior to the photographs since their values correlate with photogrammetric results only if there is little or no movement between the times each is taken.

Next, four sets of photographs were taken as illustrated in Figure 3-31. For the first set, with the subject's hands on the steering wheel, all seven cameras were used and a light was directed on the back of the seat so that the spinal markers were clearly visible in the seat-back opening. The second set, with hands dropped to the sides, was taken to obtain a clear view of the torso and abdominal markers using cameras 1, 2, 3, and 7. In the third set of photographs, the subject held a single probe on the pubic symphysis landmark. In the fourth set, the subject held two probes on right and left anterior-superior iliac spines.

After photographic data collection, the remaining sixty anthropometric measurements listed in Table 3.12 were taken (see Figure 3-32) to complete a total of eighty-two seated measures. These measures are defined and illustrated in Appendix H. Finally, five body surface contours were taken using a specially developed contour gauge held manually against the desired body region as illustrated in Figure 3-33. Each contour was drawn on a sheet of paper and placed in the subject's file. Later, the sets of contours for each subject group and body region were traced to clear acetate paper from which an average contour was visually derived. Cardboard templates were then made and used as guides in sculpting the clay models.

3.8.4 Data Analysis and Results. Films from the seven cameras were digitized by the same procedures used in Phase II. In order to minimize the number of targets digitized per view, the digitizing program was modified to sequence through different subsets of the targets in each camera view based on the cameras that were likely to "see" the targets. For example, acromion would be included in the subsets for the right side, upper back, and upper side cameras, but not the others.

TABLE 3.12

ANTHROPOMETRIC MEASUREMENTS TAKEN IN CONTOURED HARDSEATS

<u>Pre-Photo w/o Steering Wheel</u>	Forearm Breadth (upper)
Chest Height (nipple)	Forearm Depth (upper)
Right-Left Med. Fem. Epicondyle	Wrist Breadth (condyles)
Right-Left Sphyrion	Wrist Depth (condyles)
Leg Angle (upper)	Axillary Depth
Leg Angle (lower)	Neck Circumference (mid)
	Neck Circumference (lower)
	Shoulder Circumference
<u>Pre-Photo with Steering Wheel</u>	Arm Circumference (scye)
Sitting Height	Arm Circumference (upper)
Chin Height	Arm Circumference (above elbow)
Cervicale Height	Elbow Circumference
Acromion Height	Forearm Circumference (upper)
Shoulder Height (mid)	Forearm Circumference (lower)
Chest Height (posterior scye)	Wrist Circumference (condyles)
Olecranon Height	Chest Circumference (axilla)
Iliocristale Height	Chest Circumference (nipple)
Ant.-Sup. Iliac Spine Height	Chest Circumference (10th rib)
Trochanterion Height	
Thigh-Abdom. Jct. Height	<u>Post-Photo w/o Steering Wheel</u>
Knee Height	Waist Breadth (umbilicus)
Neck Length (anterior)	Waist Depth (umbilicus)
Right-Left Med. Hum. Epicondyle	Abdominal Breadth (max.)
Right-Left Stylion	Abdominal Depth (max.)
Arm Angle (upper)	Hip Breadth (max.)
Arm Angle (lower)	Bitrochanter Breadth
	Troc.-to-Lat. Fem. Condyle
<u>Post-Photo with Steering wheel</u>	Thigh Breadth (upper)
Neck Breadth (mid)	Thigh Breadth (mid)
Neck Depth (mid)	Knee Depth (popliteal)
Neck Breadth (lower)	Knee Breadth
Neck Depth (lower)	Calf Breadth
Clav.-to-Acr. Clav. Artic.	Calf Depth
Torso Depth (upper)	Ankle Breadth (min.)
Shoulder Depth (scye)	Ankle Depth (min.)
Shoulder Breadth	Ankle Breadth (condyles)
Biacromial Breadth	Ankle Depth (condyles)
Chest Breadth (axilla)	Waist Circumference (umbilicus)
Chest Breadth (nipple)	Abdominal Circumference (max.)
Arm Breadth (upper)	Thigh Circumference (upper)
Arm Depth (upper)	Thigh Circumference (mid)
Arm Breadth (above elbow)	Knee Circumference
Arm Depth (above elbow)	Calf Circumference
Elbow Breadth	Ankle Circumference (min.)
Elbow Depth	Ankle Circumference (condyles)



FIGURE 3-30. Pre-photo measurement of chest height (nipple).

Film plane image coordinates resulting from digitization were transformed into laboratory X_L , Y_L , and Z_L coordinates using DLT calibration coefficients resulting from a new set of camera calibration photos taken just prior to Phase III testing. For each subject group, the target coordinate data were combined with the seated anthropometry and standard anthropometry data that were input to the Michigan Computer System (MTS) by keypunching. The resulting data sets were examined and edited for bad points using histogram and scatter plot displays of variables, listings of variables by individual subject, and descriptive statistics of variables by subject group. Where target coordinate "outliers" were found, the specific film frames involved were redigitized in an attempt to correct the problem points. In general, there were very few points that could not be corrected as indicated by a sample size of twenty-five for most variables.

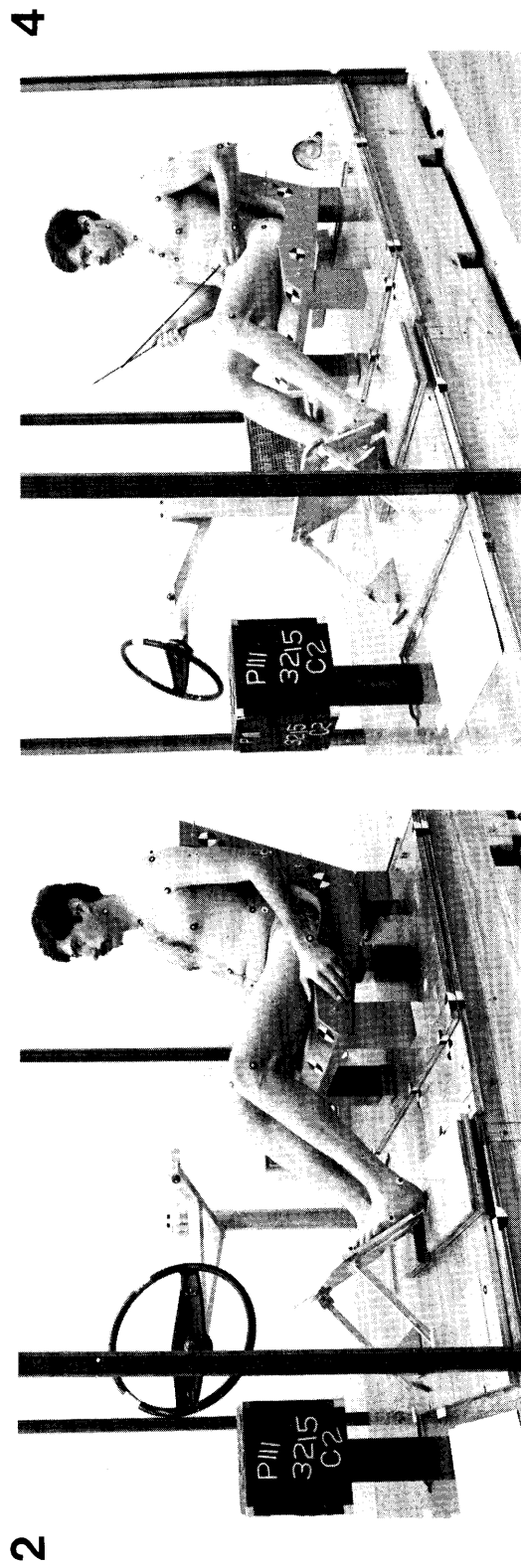
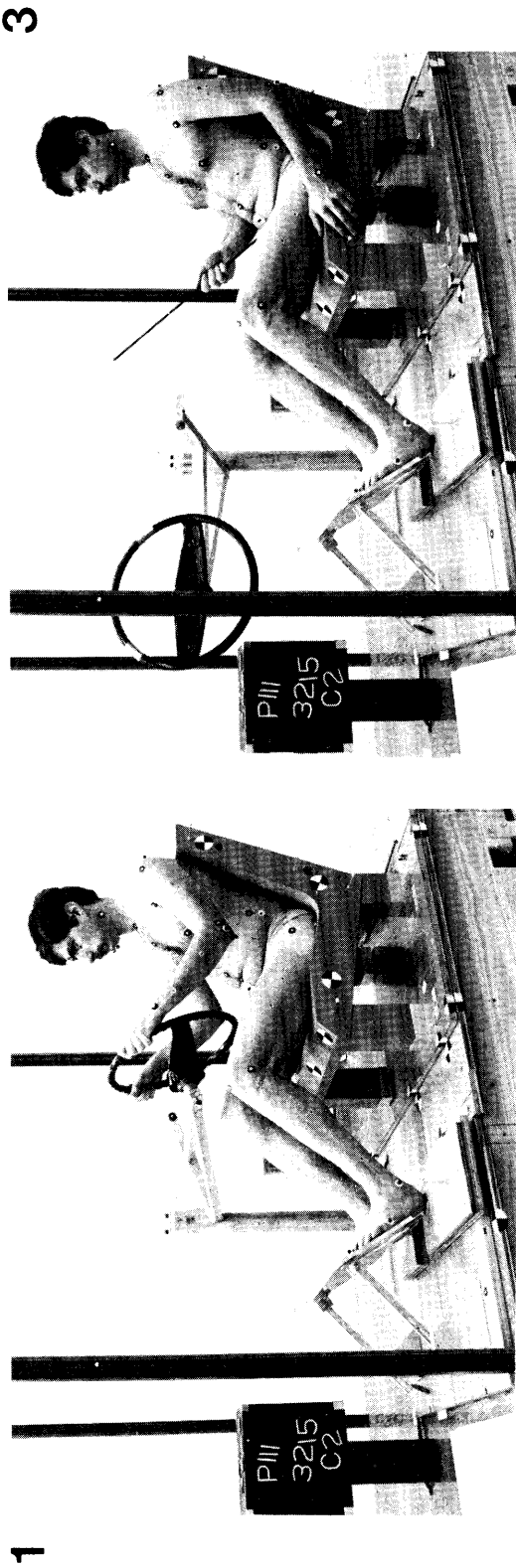


FIGURE 3-31. Mid-Sized male subject seated in hardseat buck illustrating sequence of four subject positions for photogrammetry.

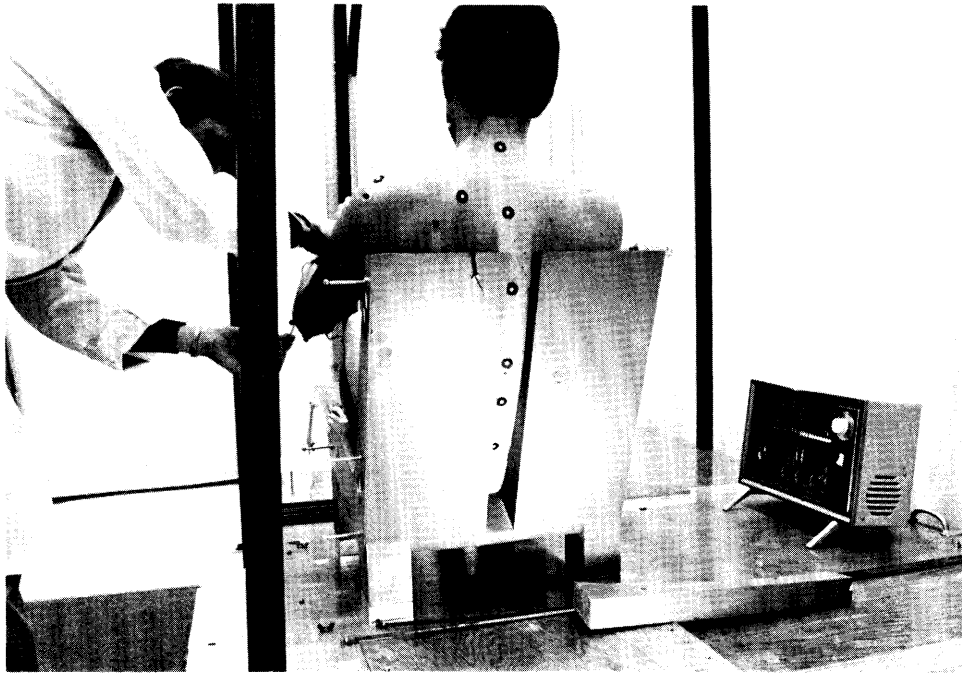


FIGURE 3-32. Measurement of arm circumference during Phase III.

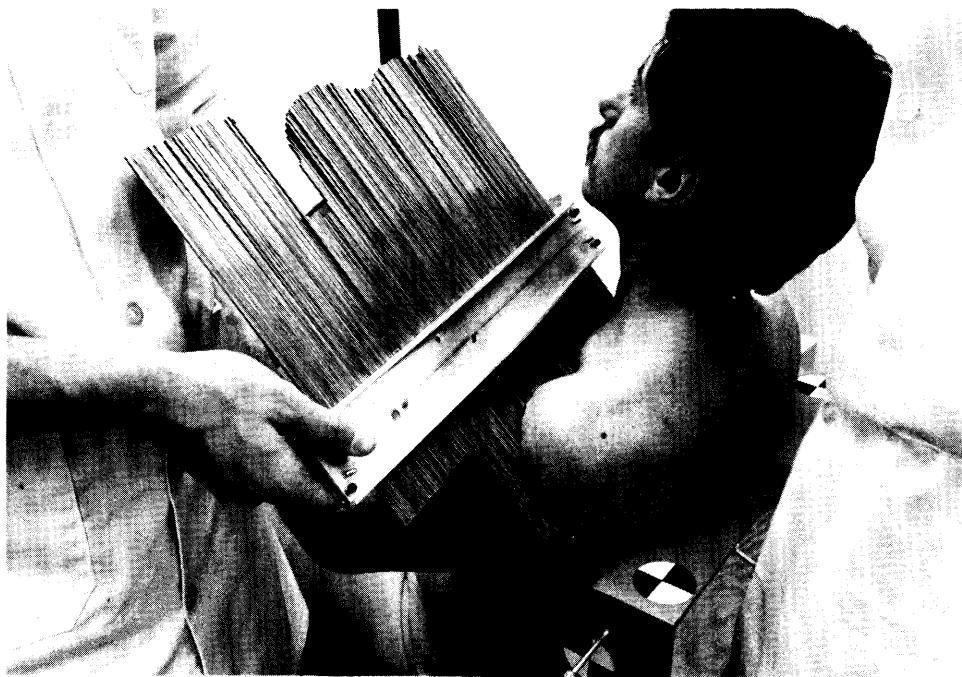


FIGURE 3-33. Measuring contour of shoulder with large contour gauge.

As an additional check, and in order to provide a consistent set of data between seated anthropometry and target data, vector distances between pairs of targets were calculated and compared with appropriate measured values. For example, the distance between lateral femoral condyle and medial femoral epicondyle should be approximately equal to the measurement of knee breadth. Similarly, Z_L coordinate values minus the Z_L coordinate of the buck platform should be equal to the measured heights if no subject movement occurred between measurements and photographs. Thus, chest height (posterior scye) should be equal to the adjusted Z_L coordinate of posterior scye. These and other comparisons were made for the results in each subject group, and where inconsistencies were found, appropriate adjustments were made (based on a best determination of the source of the discrepancy) to produce compatible sets of measured and target data. In general, the adjustments required were small and within the range expected from photogrammetric measurement and subject movement error sources.

Tables 3.13 and 3.14 contain the mean values of seated anthropometric measures and landmark laboratory system coordinates for each of the subject groups. The seated height measures (e.g., trochanter height, nipple height) are given relative to the Z_L coordinate of the final seat assembly surfaces which is 19 mm (3/4 in.) greater than the Z_L coordinate of the measurement buck surface. Tables in Appendix I contain the statistical descriptions of these seated anthropometric measurements and surface landmarks.

TABLE 3.13

MEAN VALUES OF CONTOURED HARDSEAT ANTHROPOMETRY
(cm or as noted)

Measurement Variable	Small Female	Mid-Sized Male	Large Male
Sitting Height	93.3	100.3	102.9
Cervicale Height	71.2	75.3	78.2
Chin Height	73.2	77.4	80.6
Neck Length (anterior)	8.1	8.5	9.8
Neck Breadth (mid)	9.1	11.4	12.6
Neck Depth (mid)	9.0	11.5	12.6
Neck Circumference (mid)	30.4	38.3	42.1
Neck Breadth (lower)	10.4	12.2	13.6
Neck Depth (lower)	9.3	11.5	13.1
Neck Circumference (lower)	32.2	39.3	43.3
Shoulder Height (mid)	68.2	72.1	74.7
Acromion Height	64.3	68.3	70.5
Clav.-to-Acr. Clavic. Artic	15.5	17.4	19.1
Shoulder Breadth	38.0	46.8	50.2
Shoulder Circumference	95.3	119.9	131.7
Biacromial Breadth	34.2	40.7	43.4
Torso Depth (upper)	9.0	11.9	13.8
Shoulder Depth (scye)	10.5	14.5	16.8
Axillary Depth	9.8	11.7	13.3
Arm Angle (upper) [deg.]	43.3	40.4	36.7
Arm Angle (lower) [deg.]	50.4	35.9	23.9
Right-Left Med. Hum. Epicondyle	30.0	33.8	37.8
Right-Left Stylium	27.2	27.0	27.6
Arm Circumference (scye)	36.9	45.3	50.6
Arm Breadth (upper)	6.7	8.6	9.8
Arm Depth (upper)	8.9	10.8	12.5
Arm Circumference (upper)	25.3	31.5	35.8
Arm Breadth (above elbow)	7.2	8.3	9.2
Arm Depth (above elbow)	7.4	8.2	9.2
Arm Circumference (above elbow)	24.0	28.4	31.3
Olecranon Height	44.4	45.0	47.6
Elbow Breadth	6.4	8.0	8.5
Elbow Depth	7.7	9.2	9.5
Elbow Circumference	23.3	28.5	30.4
Forearm Breadth (upper)	6.2	8.2	8.5
Forearm Depth (upper)	6.9	8.6	9.2
Forearm Circumference (upper)	21.5	27.5	29.6
Forearm Circumference (lower)	15.8	18.3	20.3
Wrist Breadth (condyles)	4.7	5.9	6.2
Wrist Depth (condyles)	3.4	4.1	4.5
Wrist Circumference (condyles)	14.2	16.9	18.1

TABLE 3.13
MEAN VALUES OF CONTOURED HARDSEAT ANTHROPOMETRY (Continued)

Measurement Variable	Small Female	Mid-Sized Male	Large Male
Chest Height (nipple)	51.7	55.4	57.1
Chest Height (posterior scye)	55.1	57.0	57.9
Chest Breadth (axilla)	26.0	30.4	32.3
Chest Circumference (axilla)	82.4	103.9	117.1
Chest Breadth (nipple)	27.6	34.9	38.4
Chest Circumference (nipple)	83.3	101.0	115.9
Chest Circumference (10th rib)	68.9	90.9	106.5
Waist Breadth (umbilicus)	24.7	31.4	36.1
Waist Depth (umbilicus)	18.8	24.4	30.1
Waist Circumference (umbilicus)	70.8	90.4	107.5
Abdominal Breadth (maximum)	27.9	32.5	38.4
Abdominal Depth (maximum)	21.0	26.9	31.6
Abdominal Circumference (max.)	75.4	91.3	108.2
Iliocristale Height	35.3	35.7	35.4
Thigh-Abdom. Junct. Height	32.7	34.5	34.5
Ant.-Sup. Iliac Spine Height	34.2	34.7	34.9
Trochanterion Height	24.8	29.2	28.4
Hip Breadth (max.)	35.6	38.5	43.9
Bitrochanter Breadth	36.9	32.9	38.5
Leg Angle (upper) [deg.]	9.3	18.1	19.1
Leg Angle (lower) [deg.]	53.4	52.6	51.7
Right-Left Med. Fem. Epicondyle	6.4	17.4	19.6
Right-Left Sphyrion	11.3	12.2	12.6
Troc.-to-Lat. Fem. Condyle	38.1	44.7	46.6
Thigh Breadth (upper)	17.6	19.4	21.4
Thigh Circumference (upper)	50.1	57.9	63.9
Thigh Breadth (mid)	12.5	15.5	16.9
Thigh Circumference (mid)	42.7	50.4	55.9
Knee Height	38.8	45.3	47.8
Knee Breadth	8.7	10.1	11.1
Knee Depth (popliteal)	11.1	13.2	14.5
Knee Circumference	33.9	39.2	43.4
Calf Breadth	9.4	11.0	12.1
Calf Depth	9.6	11.8	12.8
Calf Circumference	31.5	37.3	40.6
Ankle Breadth (min.)	6.0	6.1	6.6
Ankle Depth (min.)	6.7	7.6	8.2
Ankle Circumference (min.)	21.4	22.9	24.7
Ankle Breadth (condyles)	6.3	7.3	7.7
Ankle Depth (condyles)	8.1	9.4	10.2
Ankle Circumference (condyles)	22.0	26.1	28.7

TABLE 3.14

MEAN VALUES OF SURFACE LANDMARK LABORATORY COORDINATES (mm)

Reference No. and Landmark	Coord.	Small Female	Mid-Sized Male	Large Male
HEAD AND NECK:				
1. Glabella	X	665	577	507
	Y	619	619	619
	Z	1003	1073	1093
2. Infraorbitale	X	652	561	490
	Y	651	653	656
	Z	975	1042	1059
3. Tragon	X	575	472	406
	Y	686	702	702
	Z	970	1036	1055
4. Gonion	X	588	484	423
	Y	674	689	689
	Z	909	966	985
5. Gnathion	X	664	556	510
	Y	619	619	619
	Z	890	933	964
SPINE AND SCAPULA:				
7. C7	X	517	391	318
	Y	619	619	619
	Z	870	911	940
8. T4	X	496	364	285
	Y	619	619	619
	Z	789	802	830
9. T8	X	508	373	291
	Y	619	619	619
	Z	667	675	693
10. T12	X	555	411	335
	Y	619	619	619
	Z	547	568	564
11. L2	X	575	440	372
	Y	619	619	619
	Z	504	509	504
12. L5	X	601	483	416
	Y	619	619	619
	Z	448	435	428

TABLE 3.14: MEANS OF SURFACE LANDMARK LABORATORY COORDINATES (Continued)

Reference No. and Landmark	Coord.	Small Female	Mid-Sized Male	Large Male
SPINE AND SCAPULA (Continued)				
13. 10th Rib, mid-spine . . .	X	554	415	341
	Y	619	619	619
	Z	551	560	553
14. Scapula, Sup. Marg. . . .	X	493	361	287
	Y	685	698	702
	Z	804	825	855
15. Scapula, Inf. Marg. . . .	X	505	381	317
	Y	728	745	766
	Z	717	689	680
CHEST AND TORSO:				
18. Suprasternale	X	611	518	456
	Y	619	619	619
	Z	816	857	868
19. Mesosternale	X	645	559	499
	Y	619	619	619
	Z	778	807	824
20. Substernale	X	666	585	529
	Y	619	619	619
	Z	741	758	773
21. Bimammary Midline	X	---	605	558
	Y	---	619	619
	Z	---	703	721
22. Nipple	X	716	605	559
	Y	704	732	751
	Z	675	712	729
23. 10th Rib, Ant. Midline . .	X	745	672	651
	Y	619	619	619
	Z	575	613	627
24. Umbilicus	X	756	692	678
	Y	619	619	619
	Z	566	575	581
25. Max. Abdom. Protrusion . .	X	777	713	693
	Y	619	619	619
	Z	554	551	562
26. 10th Rib	X	659	564	492
	Y	748	775	813
	Z	550	556	552

TABLE 3.14: MEANS OF SURFACE LANDMARK LABORATORY COORDINATES (Continued)

Reference No. and Landmark	Coord.	Small Female	Mid-Sized Male	Large Male
PELVIS AND HIP:				
27. Iliocristale	X	672	577	504
	Y	757	780	816
	Z	511	515	514
28. Ant. Sup. Iliac Spine . .	X	740	632	591
	Y	722	735	740
	Z	500	505	507
29. Pubic Symphysis	X	799	708	668
	Y	619	619	619
	Z	457	463	459
30. Thigh-Abdom. Junction . .	X	777	678	637
	Y	736	741	774
	Z	485	503	503
31a. Trochanterion (palpated) .	X	752	624	584
	Y	806	807	836
	Z	406	450	442
31b. Trochanterion (reconstr.)*	X	773	677	640
	Y	809	822	834
	Z	407	402	387
SHOULDER:				
33. Claviale	X	609	512	447
	Y	636	642	644
	Z	822	865	882
34. Acr.-Clav. Artic.	X	557	442	371
	Y	771	801	811
	Z	823	865	889
35. Gr. Tubercle Humerus . . .	X	603	484	433
	Y	797	837	842
	Z	805	843	878
36. Acromion	X	549	433	362
	Y	790	822	836
	Z	801	841	863
37. Scye, anterior	X	649	560	503
	Y	749	773	786
	Z	762	802	830
38. Scye, posterior	X	564	443	373
	Y	783	816	840
	Z	711	728	737

TABLE 3.14: MEANS OF SURFACE LANDMARK LABORATORY COORDINATES (Continued)

Reference No. and Landmark	Coord.	Small Female	Mid-Sized Male	Large Male
ARM AND HAND:				
39. Lat. Humeral Epicondyle .	X	767	689	652
	Y	830	861	885
	Z	631	646	679
40. Radiale	X	783	703	670
	Y	826	862	880
	Z	618	631	661
41. Med. Humeral Epicondyle .	X	770	689	645
	Y	469	792	808
	Z	615	621	645
42. Olecranon	X	789	710	666
	Y	802	829	853
	Z	602	608	634
43. Ulnar Styloid	X	885	883	880
	Y	801	810	816
	Z	808	809	807
44. Stylium	X	876	868	863
	Y	755	754	757
	Z	812	821	823
LEG AND FOOT:				
45. Lat. Femoral Condyle . . .	X	1115	1061	1029
	Y	738	808	826
	Z	497	551	566
46. Med. Femoral Epicondyle .	X	1120	1064	1032
	Y	651	706	717
	Z	494	564	584
47. Tibiale	X	1133	1081	1051
	Y	654	707	716
	Z	483	550	572
48. Patella	X	1159	1106	1078
	Y	700	769	787
	Z	516	594	611
49. Sphyrion	X	1354	1341	1339
	Y	676	680	682
	Z	253	273	278
50. Metatarsal/Phalangeal I .	X	1453	1453	1463
	Y	695	703	707
	Z	305	336	339

TABLE 3.14: MEANS OF SURFACE LANDMARK LABORATORY COORDINATES (Continued)

Reference No. and Landmark	Coord.	Small Female	Mid-Sized Male	Large Male
LEG AND FOOT (Continued)				
51. Digit II	X	1484	1496	1507
	Y	745	766	769
	Z	351	385	392
52. Metatarsal/Phalangeal V .	X	1438	1442	1450
	Y	776	793	803
	Z	278	298	304
53. Lateral Malleolus	X	1339	1337	1329
	Y	734	745	754
	Z	231	237	240
ANTHRO. MEASUREMENT POINTS				
93. Neck, mid	X	569	459	392
	Y	665	676	682
	Z	881	934	953
94. Neck, lower	X	562	453	385
	Y	641	680	687
	Z	856	914	929
95. Arm, upper	X	658	552	508
	Y	818	850	872
	Z	731	758	786
96. Forearm, upper	X	813	767	740
	Y	826	853	871
	Z	688	703	727
97. Forearm, lower	X	853	848	834
	Y	809	816	830
	Z	751	775	781
98. Thigh, upper	X	868	788	751
	Y	788	816	844
	Z	458	482	489
99. Thigh, mid	X	976	883	842
	Y	766	817	843
	Z	483	511	521
100. Calf	X	1198	1168	1150
	Y	755	799	818
	Z	381	416	427
101. Ankle	X	1281	1281	1281
	Y	736	752	762
	Z	293	300	298

*See Section 3.10, Section 5.3, and Volume 2 of this report.

3.9 Comparison of Phase II and Phase III Surface Landmark Coordinates

The primary purpose of the Phase II surface landmark data was to provide a means for quantitatively validating the hardseat measurement approach by comparing seated postures and body positions in the vehicle seats with postures and body positions in the contoured hardseats. In addition, these data provide a means for determining the effect of the casting material (Scotchcast) on posture and seated position by comparison of landmark coordinates on subjects seated in the vehicle seats with and without the Scotchcast in place. Because the seven-camera photogrammetry system was recalibrated between Phase II and Phase III measurements resulting in different reference origins for the two data sets, it was first necessary to translate surface landmark coordinates from Phase II to the Phase III reference system. This was accomplished by adding 73 mm to Phase II X_L coordinates and 79 mm to Phase II Z_L coordinates.

Table 3.15 compares the X_L and Z_L coordinate means and standard deviations (Phase III reference system) for surface landmarks on mid-sized males in Phase II vehicle-seated postures with and without the Scotchcast. Table 3.16 compares surface landmark coordinates for mid-sized males in Phase II seated postures with Scotchcast with the same subjects seated in the reference hardseat. In Figures 3-34 and 3-35, the X_L and Z_L coordinate values from these tables have been plotted where the axes of the ellipses indicate the approximate magnitudes of the standard deviations in X_L and Z_L directions. It should be noted in these comparisons that the sample sizes are specific to each landmark and that landmarks with the same sample sizes less than eight may not involve identical sets of subjects. The maximum sample size for any comparison is, of course, eight since this is the number of mid-sized male subjects used in Phase II measurements. For each landmark, the maximum sample size was used for which both sets of data contained the identical set of subjects. Thus, for infraorbitale, the full sample size of eight was used to compare Phase II with and without casting data, but since one of the Phase II subjects was not used in Phase III, the sample size for the Phase II/Phase III comparison was reduced to seven.

TABLE 3.15 MID-SIZED MALE SURFACE LANDMARK LABORATORY
X- AND Z-COORDINATE STATISTICS (mm) FOR PHASE II
WITH AND WITHOUT SCOTCHCAST ON VEHICLE SEAT

Landmark	Coord	N	PHASE II				Mean Diff.
			Without Scotchcast		With Scotchcast		
			Mean	S.D.	Mean	S.D.	
Infraorbitale	X	8	563	40	555	32	-8
	Z	8	1043	19	1047	17	+4
Tragion	X	5	469	14	464	19	-5
	Z	5	1031	25	1030	29	-1
Acromion	X	8	437	36	438	20	+1
	Z	8	850	24	857	15	+7
Trochanterion	X	7	595	17	606	10	+11
	Z	7	462	12	466	16	+4
Lat. Fem. Condyle	X	8	1052	20	1062	18	+10
	Z	8	546	38	554	32	+8
Lateral Malleolus	X	3	1378	36	1380	31	+2
	Z	3	239	18	237	17	-2
ASIS	X	8	610	17	624	0	+14
	Z	8	504	6	503	0	-1
Pubic Symphysis	X	7	709	24	703	15	-6
	Z	7	460	15	472	20	+12

TABLE 3.16

MID-SIZED MALE SURFACE LANDMARK LABORATORY
 X- AND Z-COORDINATE STATISTICS (mm):
 PHASE II IN SCOTCHCAST VS. PHASE III IN HARDSEAT

Landmark	Coord	N	Phase II Scotchcast		Phase III Hardseat		Mean Diff.
			Mean	S.D.	Mean	S.D.	
Infraorbitale	X	7	551	32	552	25	+1
	Z	7	1045	18	1043	13	-2
Tragion	X	5	464	19	468	17	+4
	Z	5	1030	29	1033	23	+3
Acromion	X	7	436	20	436	10	0
	Z	7	854	11	846	15	-8
Trochanterion	X	7	606	10	625	15	+19
	Z	7	465	16	450	10	-15
Lat. Fem. Condyle	X	7	1060	18	1058	8	-2
	Z	7	553	34	552	17	-1
Lateral Malleolus	X	4	1357	59	1339	2	-18
	Z	4	231	7	232	6	+1
ASIS	X	7	624	0	626	7	+2
	Z	7	503	0	504	6	+1
Pubic Symphysis	X	7	698	10	700	7	+2
	Z	7	469	21	459	10	-10

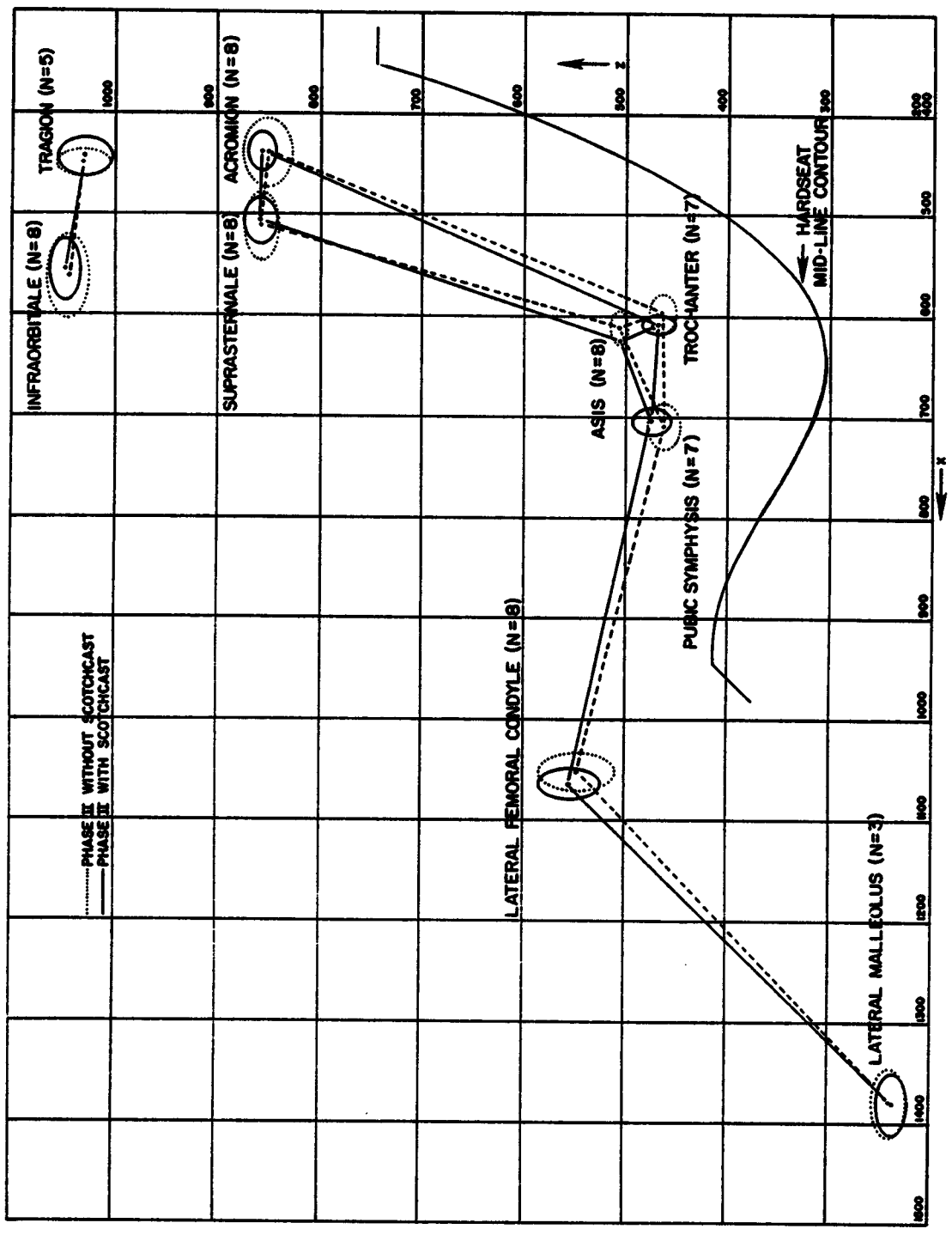


FIGURE 3-34. Comparison of Phase II surface landmark coordinates for mid-sized males sitting in vehicle seats with and without casting material.

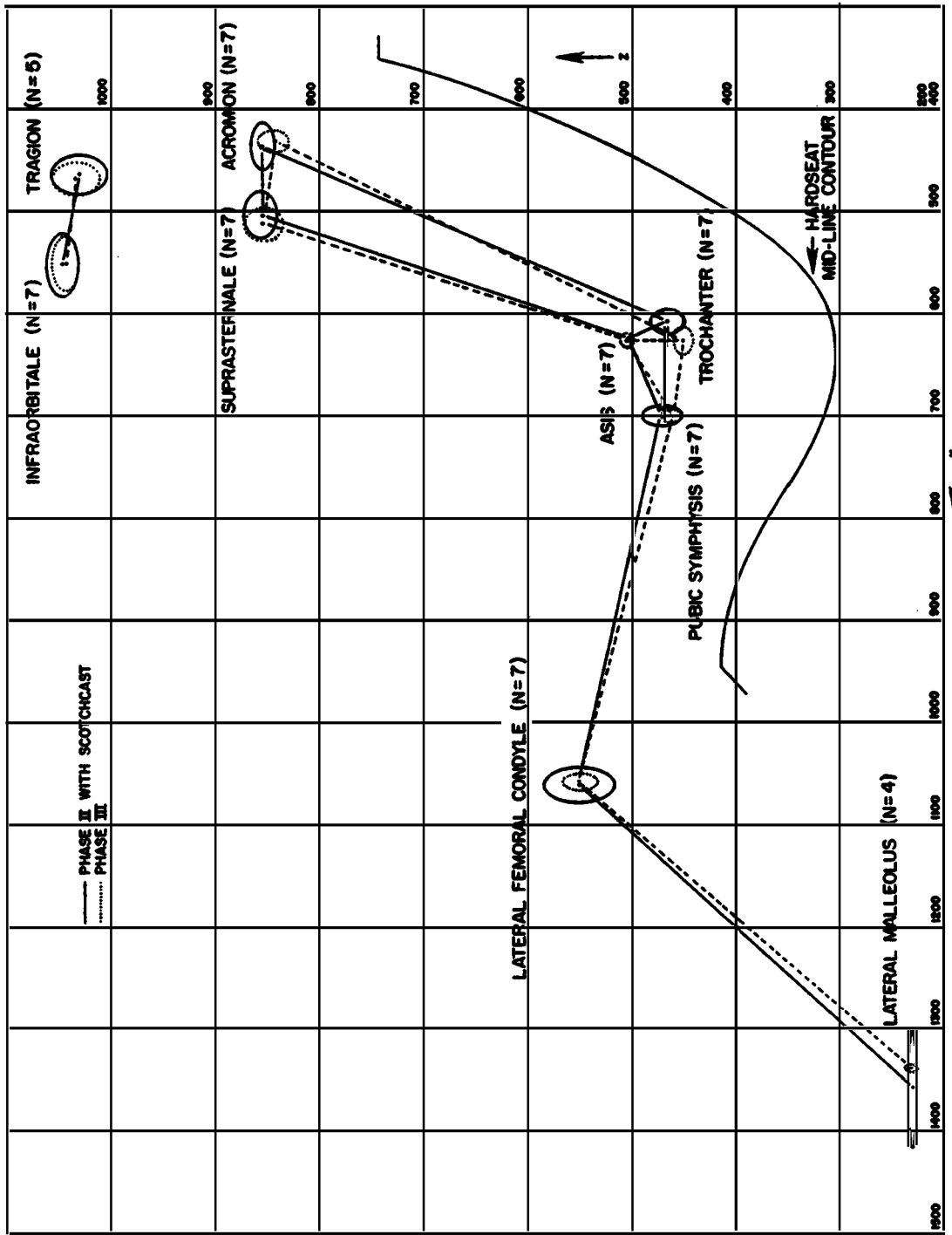


FIGURE 3-35. Comparison of surface landmark coordinates for mid-sized males sitting in vehicle seats with casting material and sitting in reference hardseats.

In general, it is observed that the mean coordinate values are extremely close in both comparisons, and this is especially striking for the head landmarks, which one might expect to show the greatest differences. Comparison of the pelvic and hip landmarks are of particular importance and it is noted that the anterior-superior iliac spines show extremely close alignment between Phase II and Phase III data. This is as one would hope, since the seat castings were merged by aligning on these landmarks, but the close match is confirmation of the validity of the hardseat measurement approach, demonstrating that the pelvic bone is located the same in the hardseat as in the vehicle seats.

It is also observed, however, that the casting process may have caused the subjects to place their pelvis a bit more forward in the vehicle seat, as indicated by the 14-mm difference in ASIS X_L coordinate values in Table 3.15. This observation is confirmed by the X_L location of trochanterion and lateral femoral condyle that are 11 mm and 10 mm forward with the Scotchcast material, but not by the X_L location of pubic symphysis that is 6 mm further back with Scotchcast. The latter point is, however, more suspect than the others due to the obvious sources of measurement error at this landmark. It is interesting to note that the Scotchcast material seems to have had little or no effect on the Z_L coordinate values of pelvic or other landmark points.

The agreement between Phase II and Phase III landmark coordinates is generally better than expected. Noted differences are:

- The lower acromion in Phase III which could indicate a more relaxed posture.
- A lower and more forward trochanterion in Phase III which is probably due largely to palpation error.
- A further back malleolus in Phase III which is due to the fact that the Phase II data include only four subjects and do not equally represent all the vehicle toeboard positions that were averaged for Phase III.
- A lower pubic symphysis in Phase III which may indicate that subjects were encouraged to press down harder with the probes in the final measurement session.

3.10 Results Relative to Vehicle Reference System

For human factors engineers concerned with vehicle packaging, it is of value to be able to describe the surface landmark coordinates in terms of the vehicle reference system, which in turn describes the position of the dummy relative to other vehicle interior components. Since four vehicle seats were merged to produce the contoured hardseats from which the dummy anthropometric specifications were determined, the design H-point and accelerator heel point, which specify the vehicle reference system for these data, must also be reported as an average or composite of the four vehicles.

During the H-point validation of each of the vehicle seat bucks, stereophotogrammetry was used to determine the laboratory X_L and Z_L coordinates of each vehicle seat's design H-point. Table 3.17 reports these values in Phase III hardseat buck coordinates (i.e., after adding 73 mm to X_L values and 79 mm to Z_L values from Phase II laboratory coordinates). Since the average vehicle detent for each subject group and vehicle seat was rounded off to the nearest integer detent setting in Phase II testing, the position of the subjects in the vehicle relative to the design H-point should be corrected for this X_L coordinate shift. This can also be accomplished by shifting the design H-point X_L coordinate value.

TABLE 3.17

PHASE III LABORATORY COORDINATES (mm)
OF DESIGN H-POINTS

Vehicle	Design Detent	X_L	Z_L
Malibu	9	592.0	389.2
Citation	9	553.2	387.6
Escort	13	567.4	419.0
Champ	10	556.1	422.0
AVERAGE		567.2	404.5

Table 3.18 shows the average in-vehicle detent settings, the buck detent setting, the detent space, and the resulting H-point shift required to adjust for this detent round-off factor. The average values across vehicles for each subject group were computed, and Table 3.19 gives the resulting design H-point coordinates, which are slightly different for each size dummy. Also presented in Table 3.19 are the corresponding accelerator heel point coordinates determined by adding and subtracting respectively the average (across vehicles) X and Z distances from H-point to accelerator heel point (857 mm for X and 251 mm for Z).

To convert laboratory surface landmark coordinates presented in this report into vehicle coordinates, the H-point or heel point coordinate values for the appropriate dummy-family member given in Table 3.19 should be subtracted from the surface landmark laboratory coordinate values. The vehicle coordinate values of design H-point or accelerator heel point should then be added to the results. For example, the mid-sized male X_L and Z_L coordinate values for left acromion are 432 and 841, respectively. For the Ford Escort the vehicle design H-point X and Z coordinate values are 3101 and 678, respectively (see Table B.2). The Escort vehicle coordinates for left acromion on the mid-sized male in the seated posture are then given by:

$$\begin{aligned} (\text{Acromion } X)_{\text{veh}} &= (\text{Acromion } X)_{\text{lab}} - (\text{H-point } X)_{\text{lab}} + (\text{H-point } X)_{\text{veh}} \\ (\text{Acromion } X)_{\text{veh}} &= 433 - 573 + 3101 \\ &= 2961 \end{aligned}$$

$$\begin{aligned} (\text{Acromion } Z)_{\text{veh}} &= (\text{Acromion } Z)_{\text{lab}} - (\text{H-point } Z)_{\text{lab}} + (\text{H-point } Z)_{\text{veh}} \\ (\text{Acromion } Z)_{\text{veh}} &= 841 - 405 + 678 \\ &= 1114 \end{aligned}$$

Thus, Escort coordinates of left acromion for the mid-sized male are:

$$\begin{aligned} X_E &= 2961 \\ Z_E &= 1114 \end{aligned}$$

where the subscript E implies Escort coordinate system.

TABLE 3.18

DESIGN H-POINT SHIFT DUE TO DETENT ROUND-OFF

Group/Vehicle	Avg Detent	Buck Detent	Detent Space (cm)	X _L Coord H-Point Shift (mm)
Small Female:				
Malibu	1.4	1	2.15	8.6
Citation	1.3	1	2.13	6.4
Escort	1.4	1	1.27	5.1
Champ	2.9	2	2.00	18.0
AVERAGE				9.5
Mid-Sized Male:				
Malibu	6.5	6	2.15	10.8
Citation	6.3	6	2.13	6.4
Escort	9.9	10	1.27	-1.3
Champ	7.4	7	2.00	8.0
AVERAGE				6.0
Large Male:				
Malibu	8.0	8	2.15	0
Citation	8.5	8	2.13	10.7
Escort	13.0	13	1.27	0.0
Champ	10.0	10	2.00	0.0
AVERAGE				2.7

TABLE 3.19

ADJUSTED DESIGN H-POINT AND ACCELERATOR HEEL POINT LABORATORY COORDINATES (mm) FOR COMPOSITE VEHICLE

Group	H-Point		Accel. Heel Point	
	X _L	Z _L	X _L	Z _L
Small Female	577	405	1434	154
Mid-Sized Male	573	405	1430	154
Large Male	570	405	1427	154

In developing the anthropometric specifications for each dummy-family member (see Section 5 and Volume 2 of this report), the palpated surface landmarks for the pelvic bone (i.e., pelvic crest and ASIS) were used, along with estimates of tissue thickness beneath the probe tips and pelvic spatial geometry data from Reynolds et al. (1981), to estimate the locations of the hip pivot points. From these coordinates and the size and orientation of the femur bones determined from Phase III measurement data, the coordinates of trochanterion for the seated dummies were computed (see Section 6.5 of Volume 2). Table 3.20 gives the X_L and Z_L coordinates for these reconstructed trochanterion landmarks and compares them with the X_L and Z_L mean coordinate values for the palpated trochanterion surface landmarks.

TABLE 3.20
PHASE III LABORATORY COORDINATES (mm) FOR PALPATED
AND RECONSTRUCTED TROCHANTERION

Form	Palpated Trochanterion		Reconstructed Trochanterion	
	X_L	Z_L	X_L	Z_L
Small Female	752	406	773	407
Mid-Sized Male	624	450	672	402
Large Male	584	442	640	387

It is seen that there are substantial discrepancies between the palpated and reconstructed trochanterion coordinates, especially for the large male and mid-sized male groups. In general, the reconstructed trochanterion is forward of and below the palpated trochanterion. The reasons for this are not fully explainable at this time, but it is suspected that a large part of the differences are due to errors in palpating the trochanterion in the seated posture. Given that the reconstruction procedure may involve errors in estimating tissue thicknesses, applying and scaling the Reynolds data, and estimating the vector distances from the hip pivot points to the trochanter of the

femurs, it is likely that some of the error is in the location of these points as well.

In Table 3.14 and the tables of Appendices I and L, the coordinates of both palpated and reconstructed trochanterion are given and are referenced as points 31a and 31b, respectively. The engineering drawings for each dummy show only the reconstructed trochanterion. Table 3.21 gives the reconstructed laboratory X_L and Z_L coordinates of the hip pivot points for the three dummy members and Figure 3-36 shows these points relative to the average vehicle design H-point and the seat midline contours.

TABLE 3.21
LABORATORY COORDINATES OF RECONSTRUCTED HIP PIVOT POINTS

Family Member	X_L	Z_L
Small Female	755	425
Mid-Sized Male	657	422
Large Male	618	409

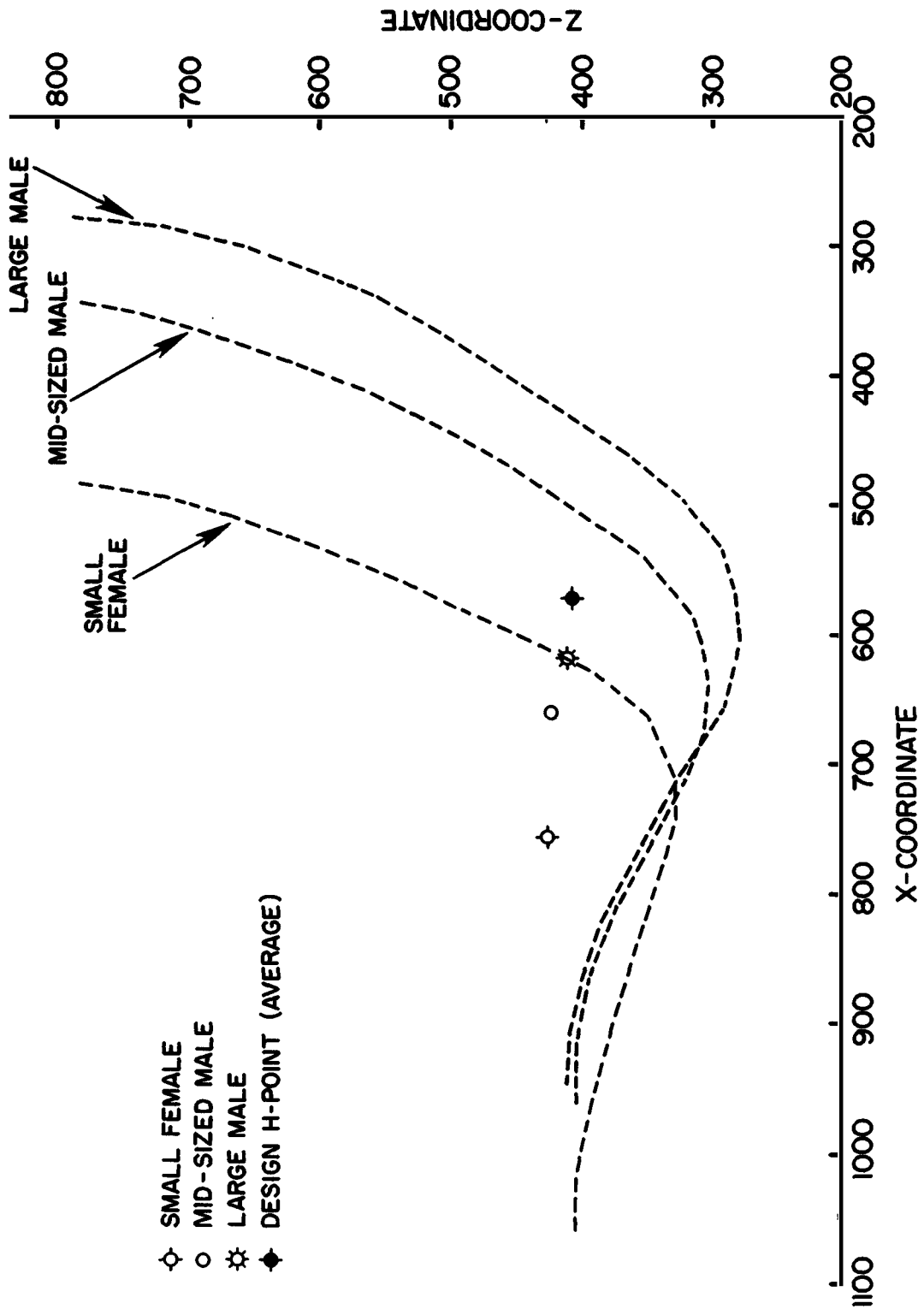


FIGURE 3-36. Comparison of reconstructed H-points with average design H-point and seat midline contours.

4.0 FABRICATION OF STANDARD REFERENCE FORMS AND SEAT ASSEMBLIES

4.1 Seat Assembly Platform and Three-Dimensional Measurement Apparatus

In order to construct the clay model of each dummy form and to sculpt the models to the X_L , Y_L , and Z_L coordinates of surface landmarks, special platforms and a three-dimensional measurement apparatus were constructed. Three platforms with toeboards were eventually built to serve as the final deliverable seat assembly bases. Each platform was constructed of four-inch aluminum channel welded to form a 29- by 60-inch frame. Two additional channel members were also welded lengthwise inside this rectangular frame at appropriate positions for attachment of the contoured hardseats. A sheet of 3/4-inch plywood was attached to the top of each aluminum frame and laminated with a sheet of .050-inch thick aluminum to form a smooth and true reference surface. The platforms were fitted with castors for mobility and with adjustable legs for leveling prior to measurement and sculpting.

The three-dimensional measurement apparatus, shown in Figure 4-1 was attached to each base platform during the model development process. Its basic construction consists of two end-frame pieces made of welded one-inch-square tubing to which is attached a rectangular top frame made of welded 2-inch by 3-inch aluminum extrusion. Another length of 2-inch by 3-inch aluminum travels side-to-side (Y_L direction) above the top frame by means of linear bearings and shafts anchored to the ends of the top frame. Longitudinal movement is provided by a carriage that rides on bearings on the 2-inch by 3-inch "beam," while vertical positioning (Z_L direction) is by means of a shaft through a housing on the side of this carriage. Vertical adjustment is achieved by a hand crank that acts through a rack and pinion to drive the shaft up and down. Motion in lateral and longitudinal directions is manually controlled and can be restricted (i.e., locked in place) by tightening the handles of lock-down screws.

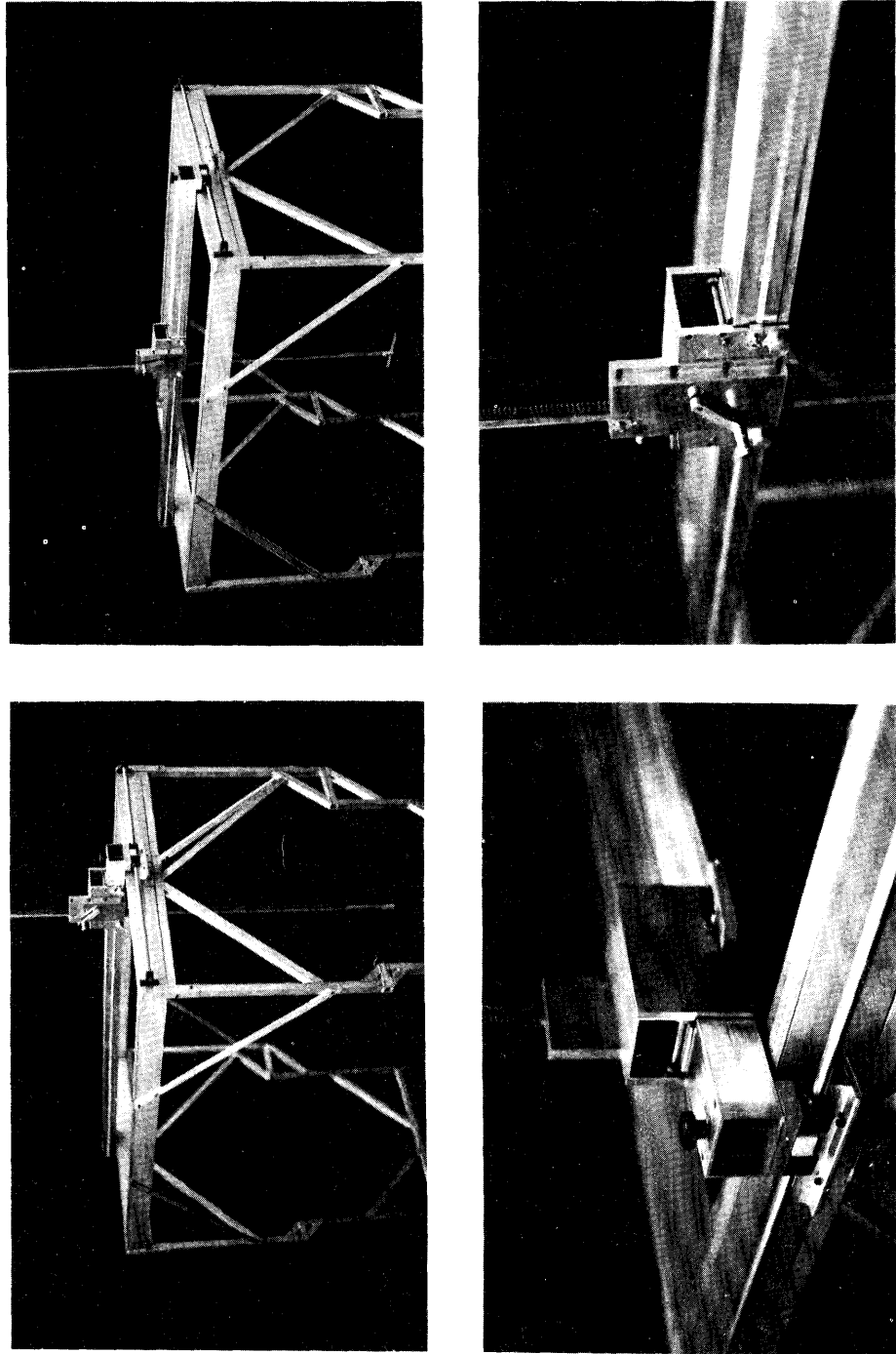


FIGURE 4-1. Three-dimensional measurement apparatus used to construct the clay models.

In order to set or read the coordinates of a point, three separate scales are used. The Z_L coordinate is read at a gauge on the top of the vertical shaft housing from a scale placed inside the vertical shaft. The Y_L coordinate is read from a scale placed along the top edge of the rectangular top frame at one end and uses the left side of the 2-inch by 3-inch beam as a gauge. The X_L coordinate is read at a gauge on the right side of the carriage along a scale attached to the top beam. The end of the vertical shaft can be fitted with either a vertical or horizontal pointer appropriate to the measurement being taken. For the latter, the distance of the pointer tip from the shaft center is adjustable and must be accurately set and subtracted or added to the X_L or Y_L coordinate reading taken from the scale.

4.2 Construction of Clay Models

Two approaches were used in the construction of the clay models. For the mid-sized male, which was sculpted first, an adjustable clay armature was fabricated from acrylic castings of skeletal components as illustrated in Figure 4-2. It was originally believed that this technique would provide useful anatomical input to the sculptors, and, to some extent, it did. Based on the linkage anthropometry data collected, an attempt was made to locate skeletal components that matched the average bone dimensions of the mid-sized male subjects. It soon became apparent, however, that this was a task that could not be accomplished under the time constraints of the current project (if at all) for the "average" male, much less for the small females and large males.

It was therefore decided that a reasonably closely sized skeleton would be used and that the significant skeletal features (e.g., the ends of long bones) would be molded, cast in acrylic, and reassembled using adjustable steel shafts. The result was intended to be an adjustable armature that could be used for all three clay models. The experience with the mid-sized male model, however, was that the disadvantages of this armature outweighed the anatomical advantages. It was virtually impossible to produce a skeletal armature correct in all dimensions and it was necessary on several occasions during the clay

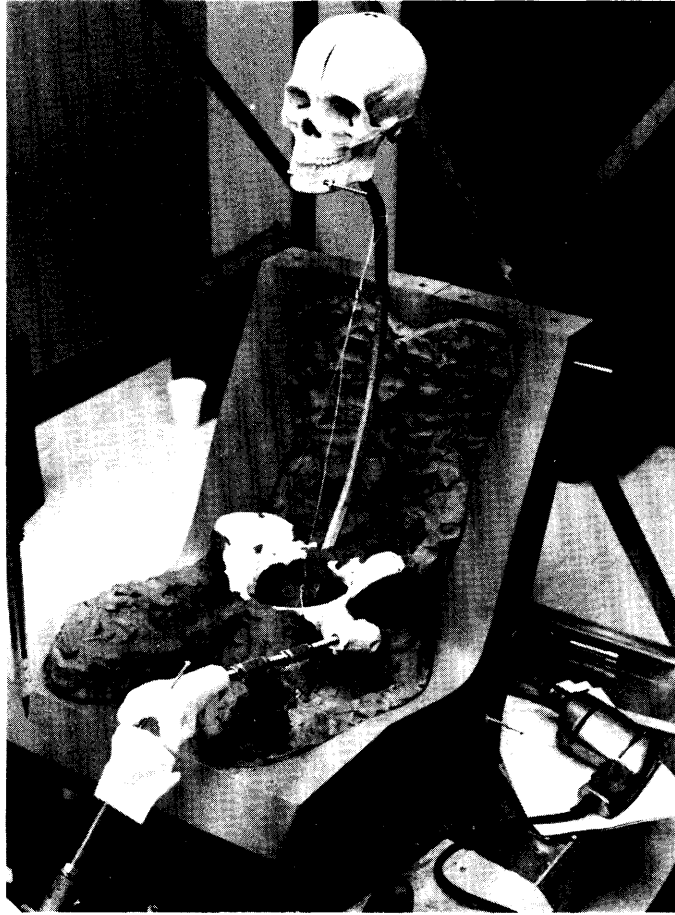


FIGURE 4-2. Adjustable skeletal armature used for mid-sized male clay model.

sculpting to saw or drill away acrylic bone that was protruding beyond a surface landmark. In addition, the skeletal armature proved to have less than ideal stability and rigidity.

As a result of this experience, a different approach was used in constructing the armatures for the small female and large male models. As illustrated in Figure 4-3, rectangular steel bars were cut, bent, and welded into place on the hardseat to form the basic support structure. Using the three X_L , Y_L , and Z_L coordinates of surface landmarks, full-size front and side view sketches were made to determine the sizes, positions, and orientations of the steel links required to ensure that the armatures would lie completely inside the clay models. The resulting structures proved to be much more stable and rigid than the adjustable skeletal armature, and, in fact, did not require external supports for the arms. As shown in Figure 4-4, dense styrofoam was cut and glued to the steel armatures to fill out the bulk of the models and reduce the quantity of clay required.

The actual sculpting of all the clay models proved to be a unique blend of art and engineering in attempting to produce forms that were both artistically appealing and realistic and yet engineeringly accurate and symmetric. Slides of typical seated subjects in each group were used as visual guides by the sculptors, and the knee, shoulder, and thigh contour templates were used to develop the shapes of these particular body regions. The main effort, however, went into sculpting to the surface landmark coordinates and seated anthropometric measures on both the left and right sides. Repeated checks and rechecks of landmark coordinates and anthropometric dimensions were performed in this laborious process.

For the mid-sized male, the model was constructed using a soft "green" modeling clay known as Plasticine, as illustrated in Figures 4-5 and 4-6. While this clay is easy to work, it produces a model with borderline dimensional stability. It is also impossible to obtain a smooth, unrippled finish which leads to the need for significant smoothing (i.e., body work) on the assembled shell. As a result of these considerations, an industrial styling clay (HBX-2) was used for the outer layer of both the small female and large male models. This

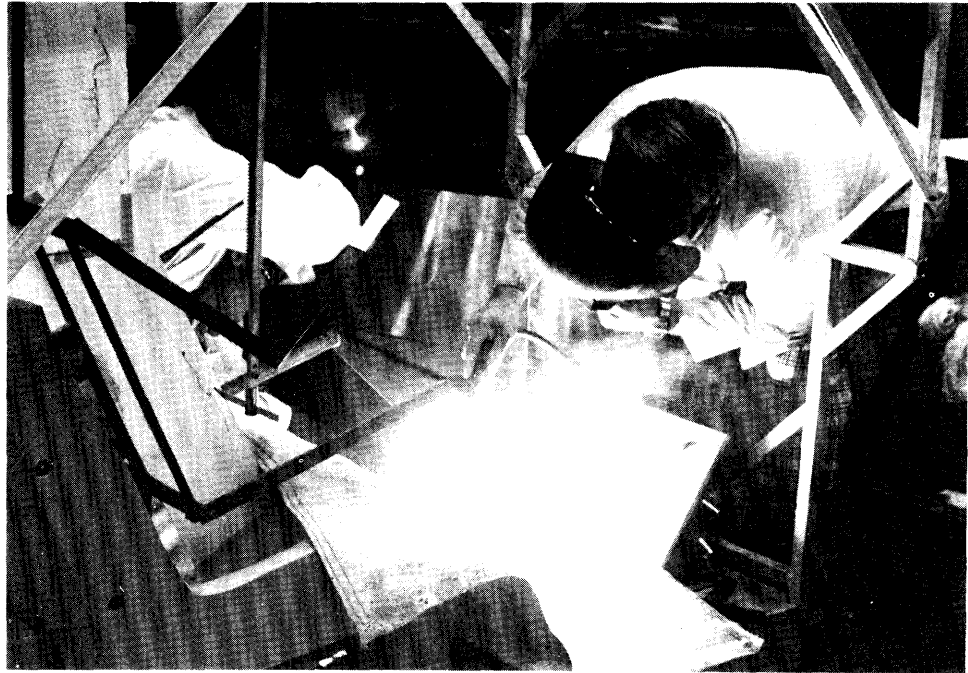


FIGURE 4-3. Fabrication of steel armature for large male model.



FIGURE 4-4. Attaching styrofoam to welded steel armature.

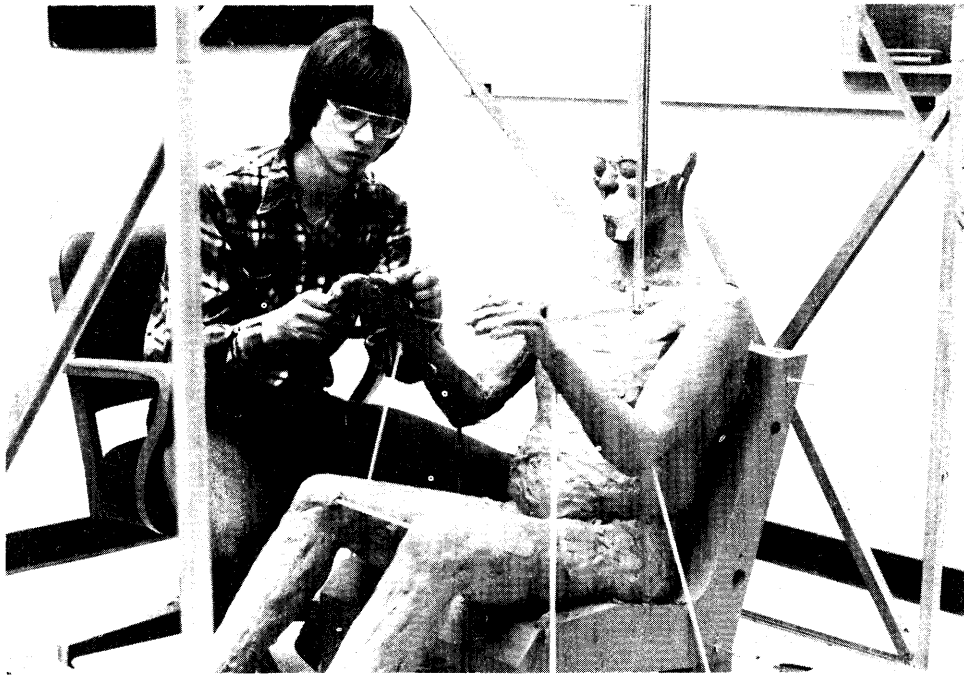


FIGURE 4-5. Modeling the mid-sized male with Plasticine.

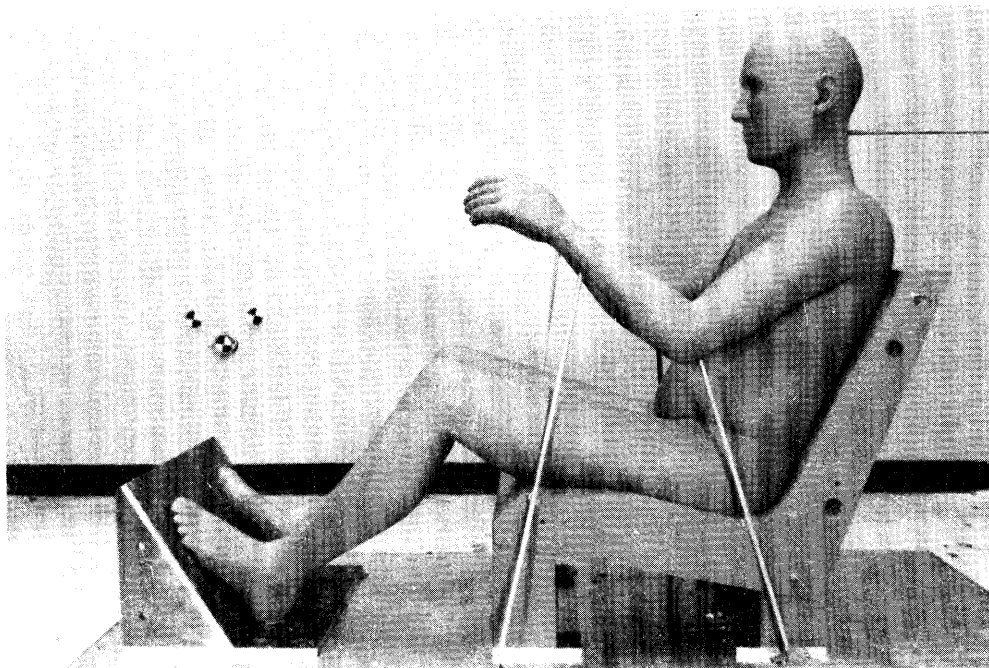


FIGURE 4-6. Completed mid-sized male clay model.

material is much more difficult to work with than the Plasticine and requires a low temperature oven to warm it to a workable softness, but it produces a more stable and rigid surface that can be shaved and worked to a finer and smoother finish. Figure 4-7 illustrates the use of this clay on the small female model.

Figures J-1 through J-3 provide a more complete picture of the model development process for the three size dummy forms. Upon completion of each model, but prior to final smoothing, paper tape lines were placed along the body surface contours as shown in Figures 4-8 and 4-9, and the surface outlines were digitized using the three-dimensional measurement device. These data were then plotted on the engineering drawings produced for each dummy.

4.3 Fabrication of Molds and Epoxy Shell Surface Forms

A multi-piece plaster "waste" mold was made from each completed clay model using the techniques illustrated in Figures 4.10 through 4.17 and Appendix J. Metal shim stock (.005-inch thick) was carefully positioned and pushed into the clay to form seams between molded parts, and pairs of steel plates were bolted to the shim stock to align and lock the molded parts together. With these dividers and fasteners in place, a mold release agent was painted on the clay surface followed by a coating of high quality, dimensionally stable plaster (Ultracal 60 gypsum cement). This was followed by buildup of plaster and hemp to produce a uniformly thick plaster/fabric mold. After twenty-four hours of hardening, the bolts were removed and the mold pieces with imbedded steel plates were separated and freed from the clay surface.

Each mold piece was then carefully inspected, cleaned, repaired if necessary, and prepared for use by coating with a sealer and several layers of paste wax. A thick layer of epoxy surface coat was painted on each prepared part, followed by lay-up of multiple layers of fiberglass and epoxy resin. As shown in Figure 4-15, the back and seat of the dummy forms were made using the waxed contoured hardseats for the molds. Parts of the mold forming the dummy sides and containing epoxy/fiberglass layers were located and assembled on the hardseat as shown.



FIGURE 4-7. Sculpting the small female model using HBX-2 clay.

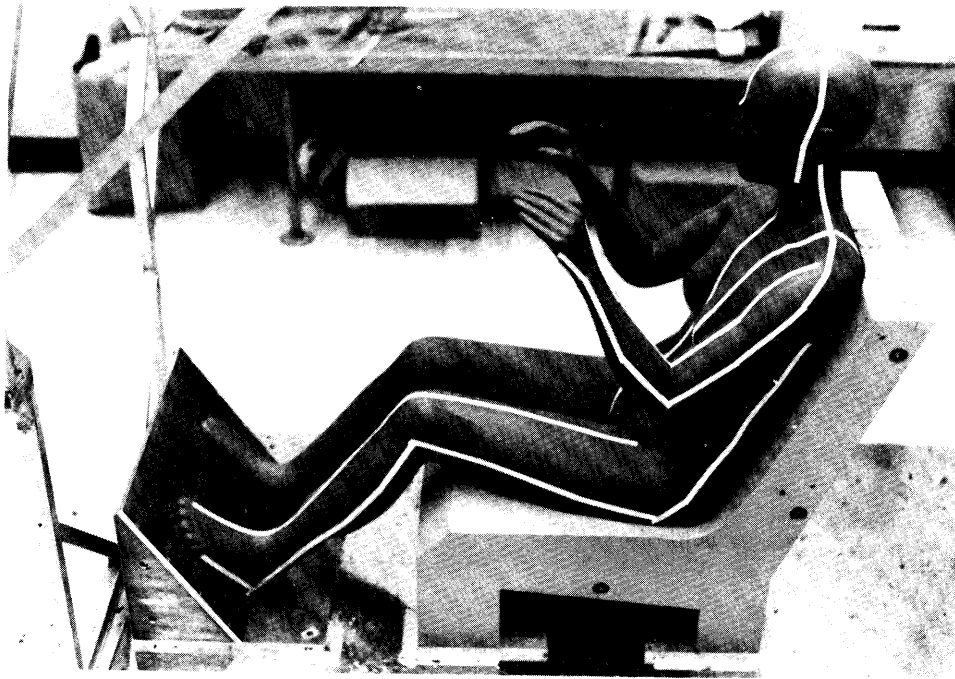


FIGURE 4-8. Completed small female clay model with lines for digitizing surface outlines.

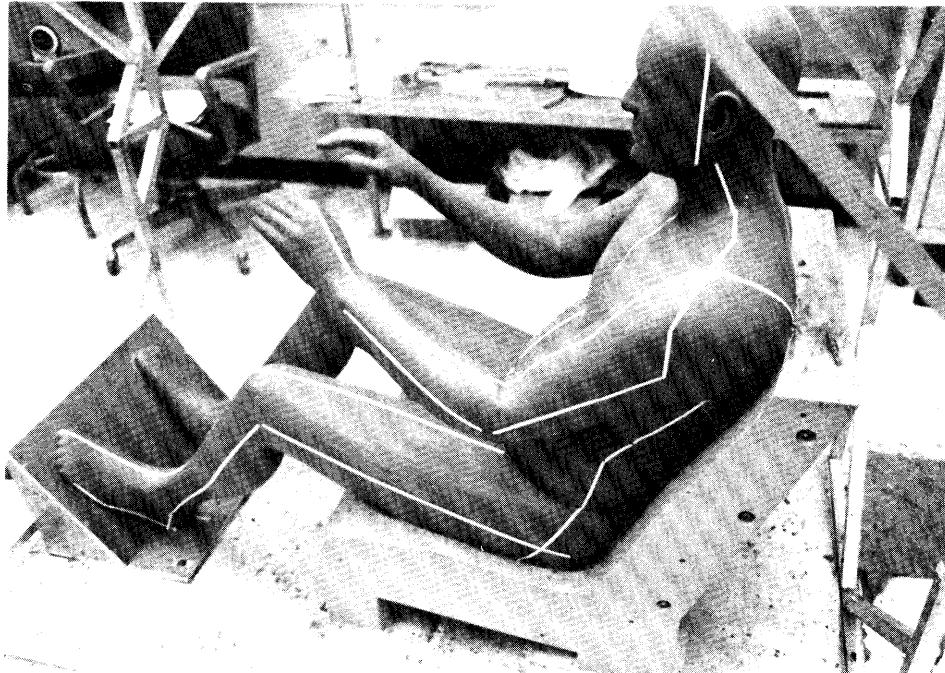


FIGURE 4-9. Completed large male clay model with lines for digitizing surface outlines.

Four holes were drilled in the hardseat and lined with metal sleeves. Locating pins were fabricated and placed in these holes and fitted with matching receptacles before epoxy and fiberglass coatings were laid-up and seamed to the assembled parts. The receptacles were thereby molded into the shell so that each completed form fits and locks securely into its seat.

The remaining mold parts containing epoxy/fiberglass layers were assembled and seamed together using the locating bolts and hardware. The assembled shells were smoothed and sanded using REN 1710 epoxy weld as a filler. The shells were then primed and blocked, sprayed with a sealer coat, and finally painted with an epoxy paint. Contoured hardseats and toeboards were finished in a similar manner, and the completed shells and seats were assembled on the platforms which were laminated with Formica for increased durability.

Using the three-dimensional measurement device, X_L , Y_L , and Z_L coordinate values of surface landmarks were located on the finished shells. Black (skeletal surface points) and gold (non-skeletal surface points) anodized rivets were inserted and glued into holes drilled at these surface landmark points. Table K.1 and the figures in Appendix K identify these rivet markers on the three surface forms with the reference landmark numbers used on the engineering drawings.

Figures 4-18 through 4-21 show the completed surface shells and seat assemblies for the three dummy-family members, while Tables L.1 through L.6 list the desired (mean values of subjects) versus actual values achieved in these surface shells for anthropometric measures and landmark coordinates.

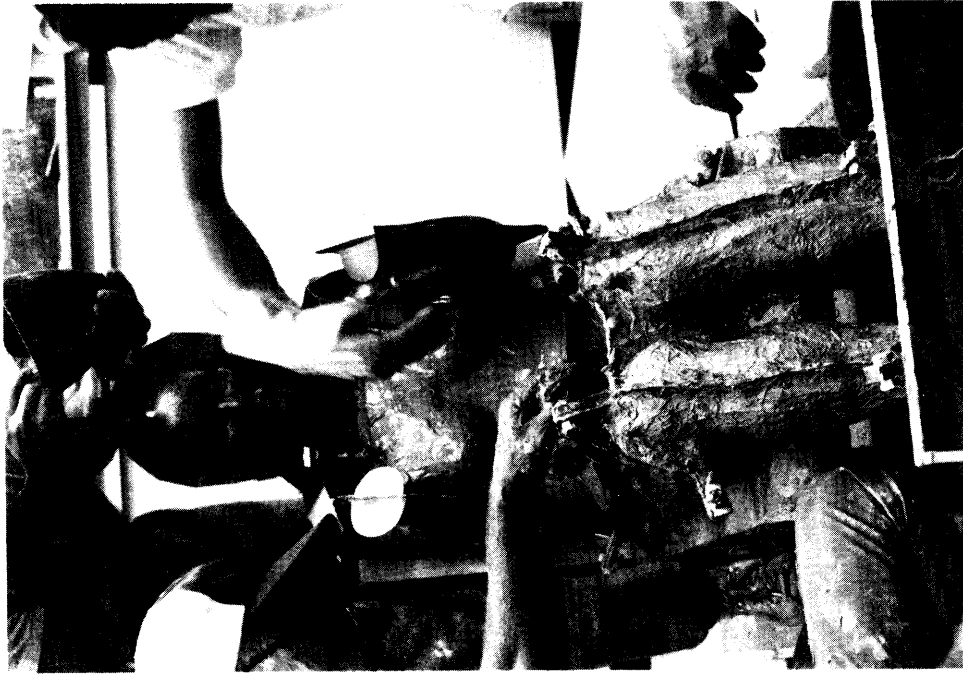


FIGURE 4-11. Making plaster/hemp mold.

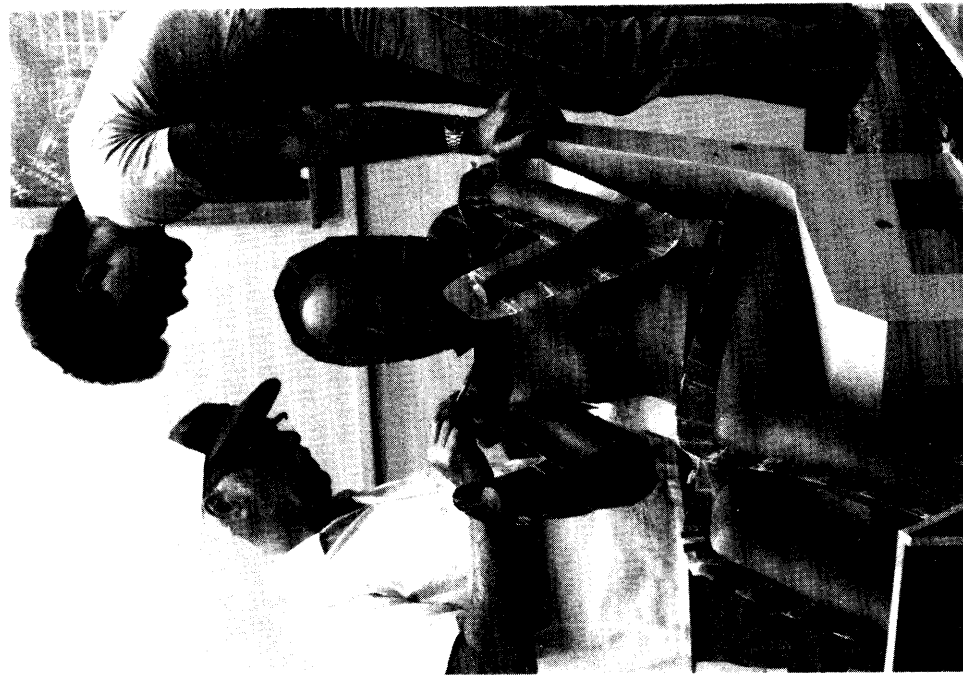


FIGURE 4-10. Placing metal shim stock into completed clay model to divide plaster mold into sections.

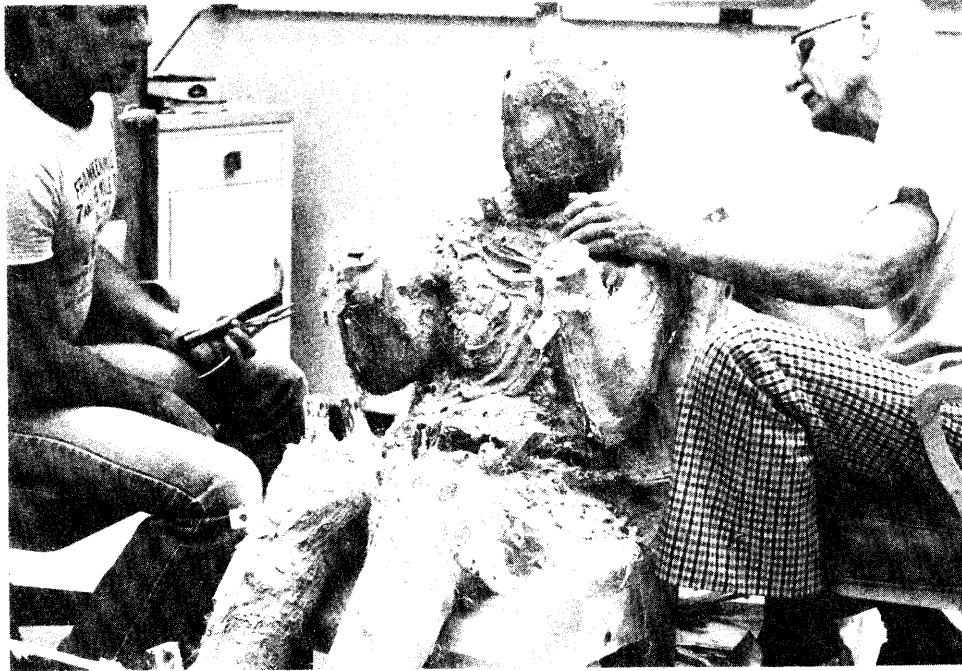


FIGURE 4-12. Hardened plaster mold ready for removal from clay.



FIGURE 4-13. Removing plaster mold parts from small female clay model.

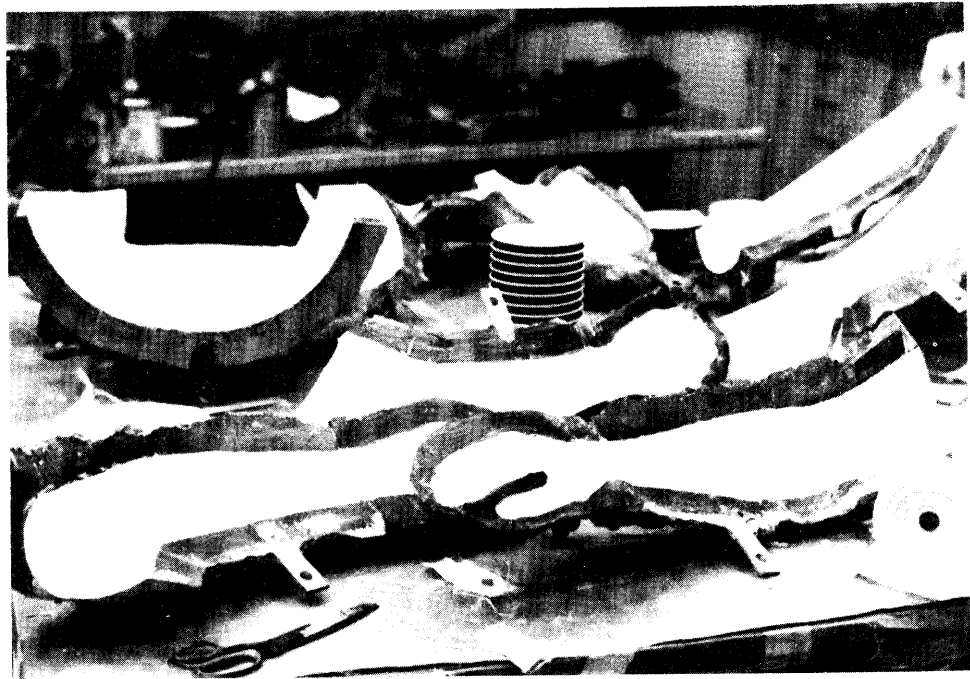


FIGURE 4-14. Laying up epoxy/fiberglass in mold parts.

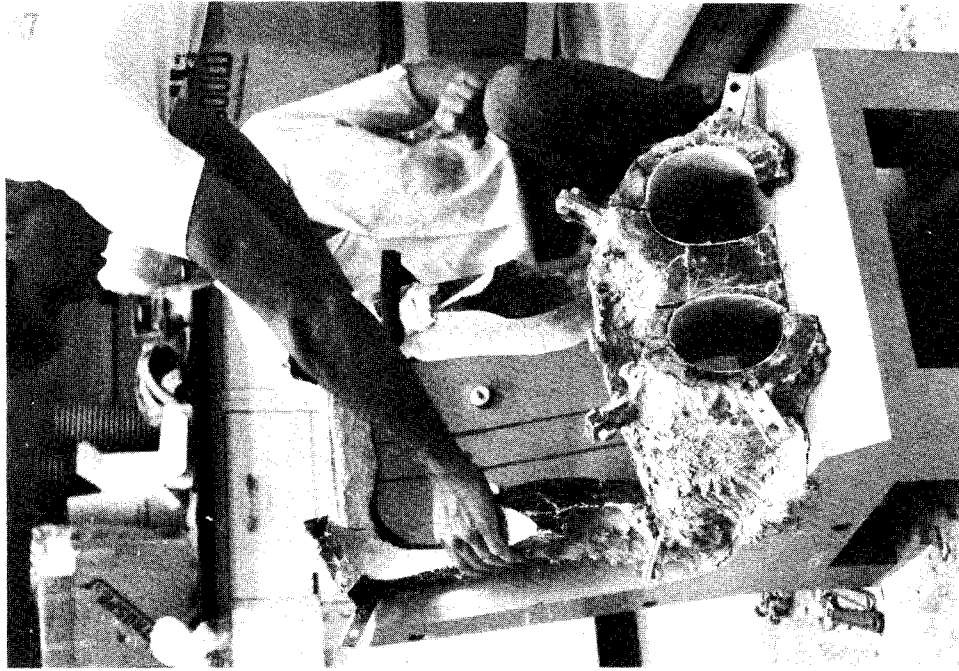


FIGURE 4-15. Assembling mold parts on hardseat to lay-up back side of shell using seat as the mold.

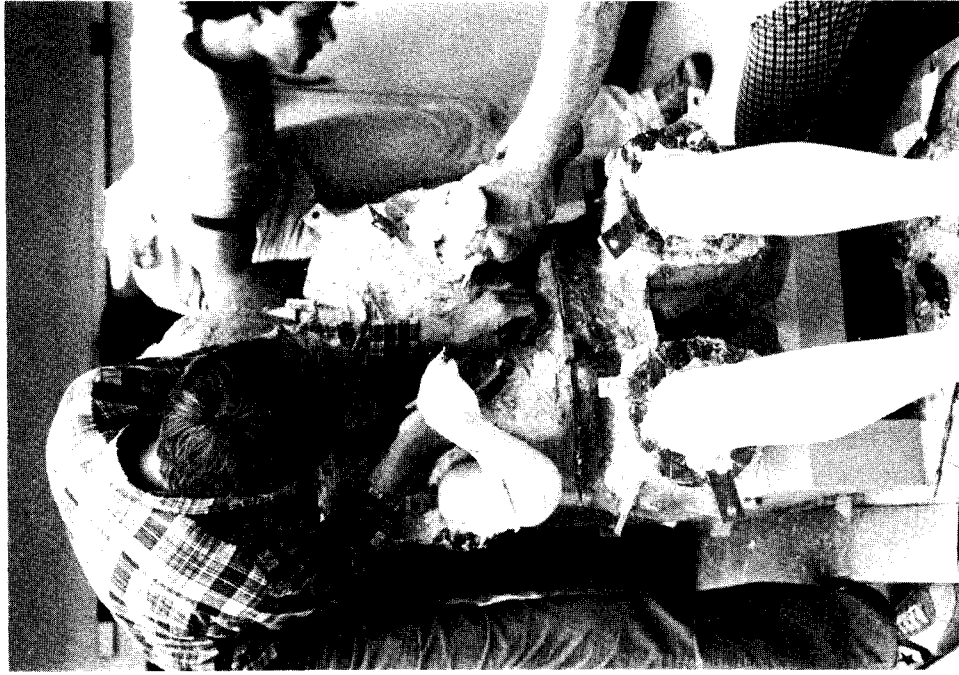


FIGURE 4-16. Removing mold parts from assembled shell.



FIGURE 4-17. Finishing and painting the assembled shells.

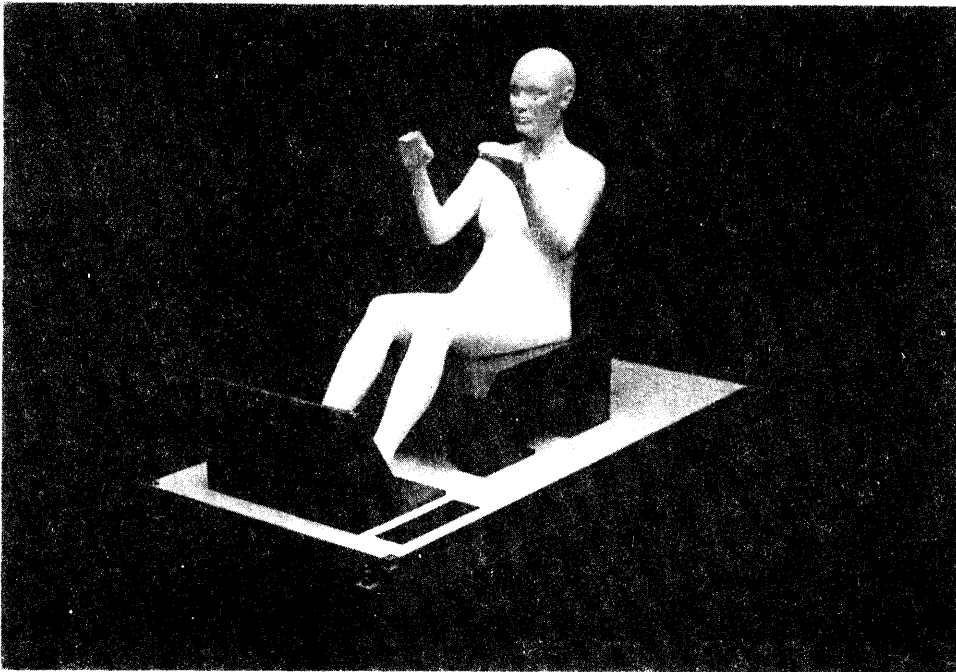
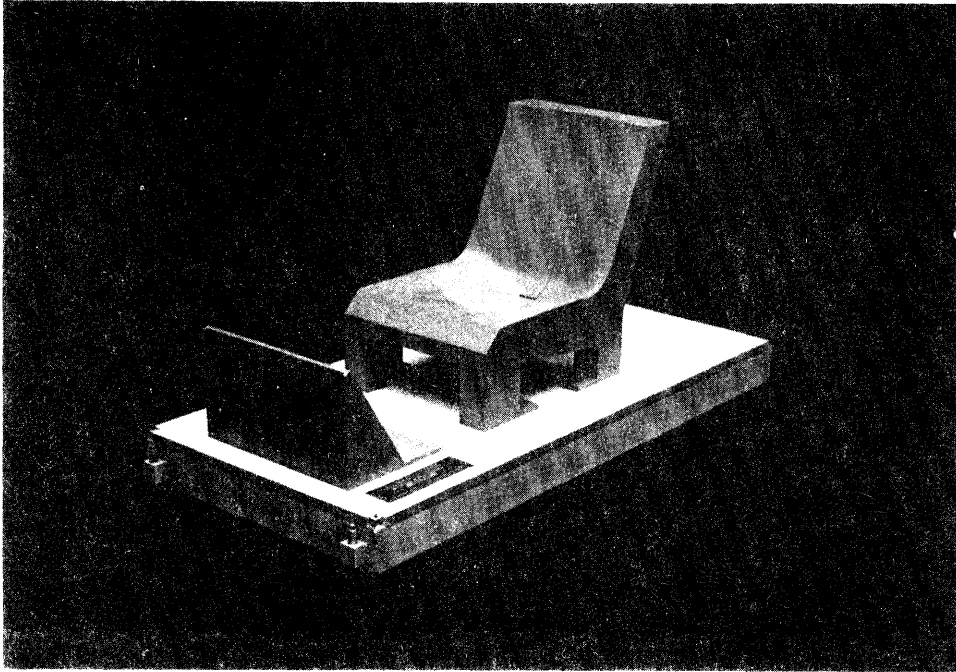


FIGURE 4-18. Small female completed seat assembly and shell.

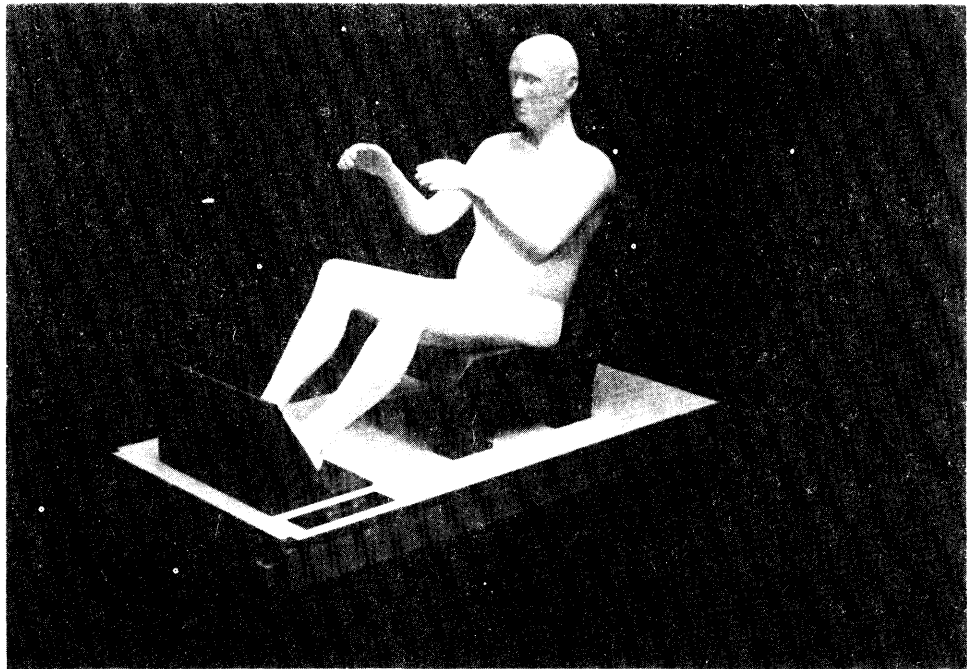
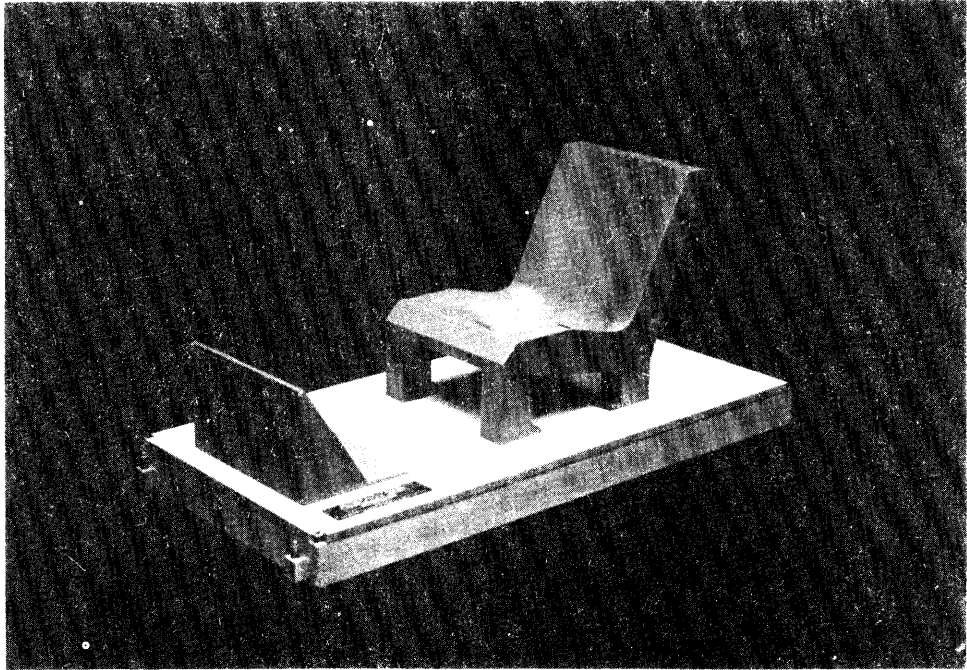


FIGURE 4-19. Mid-sized male completed seat assembly and shell.

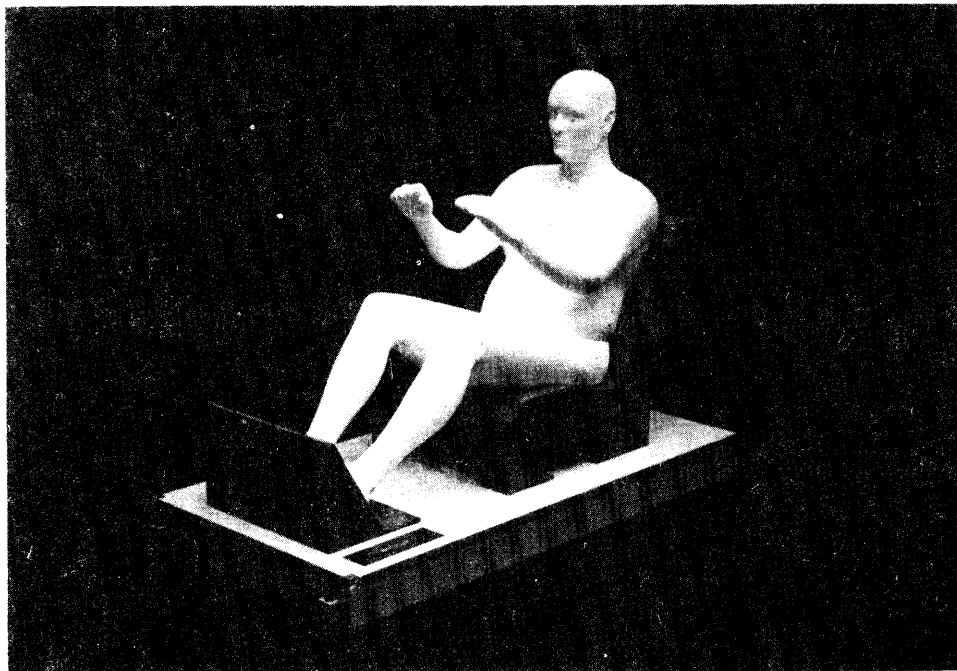
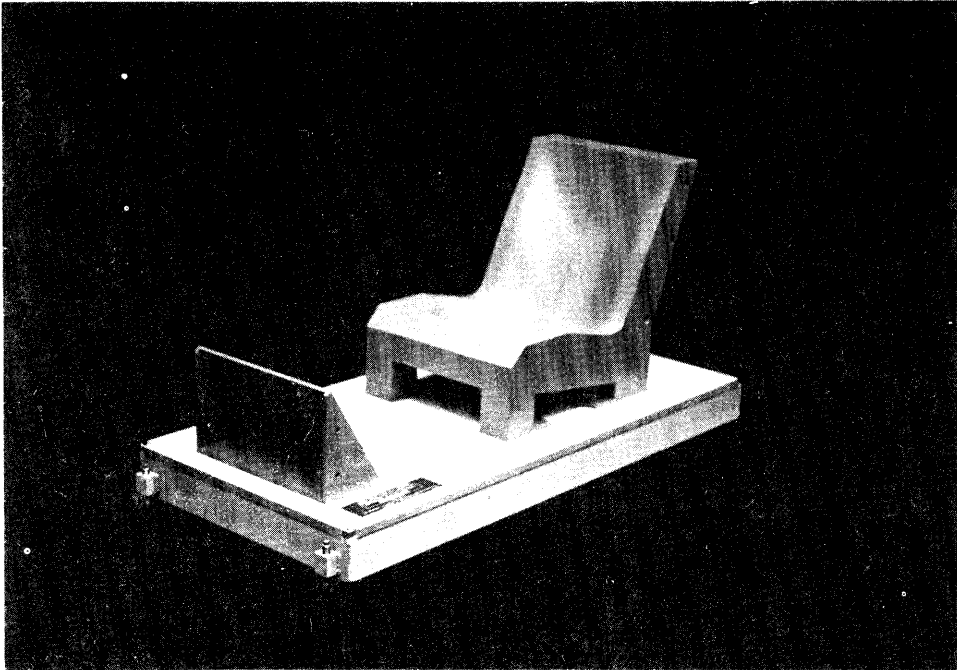


FIGURE 4-20. Large male completed seat assembly and shell.

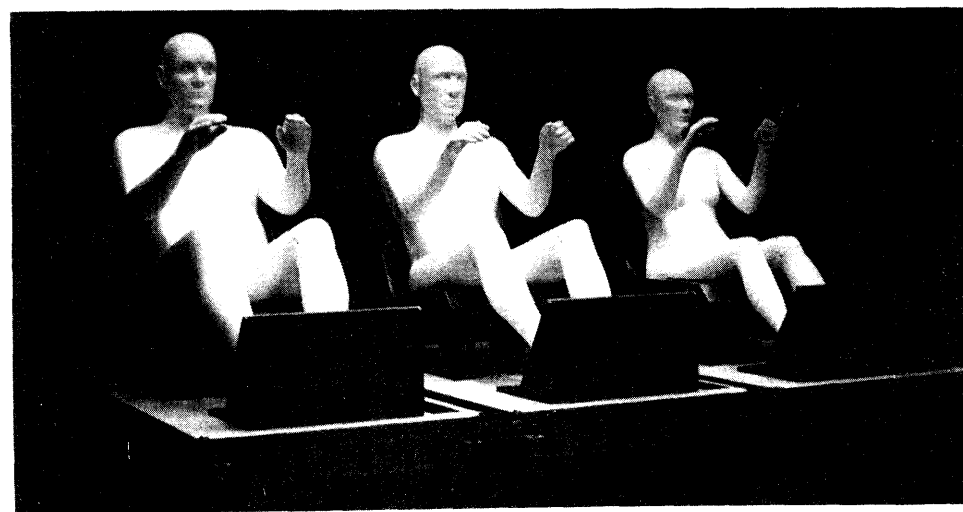
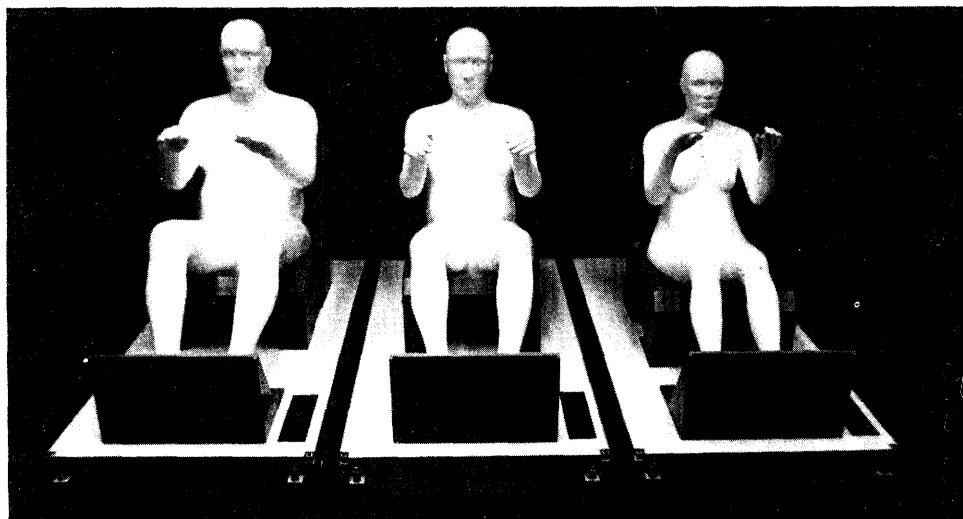
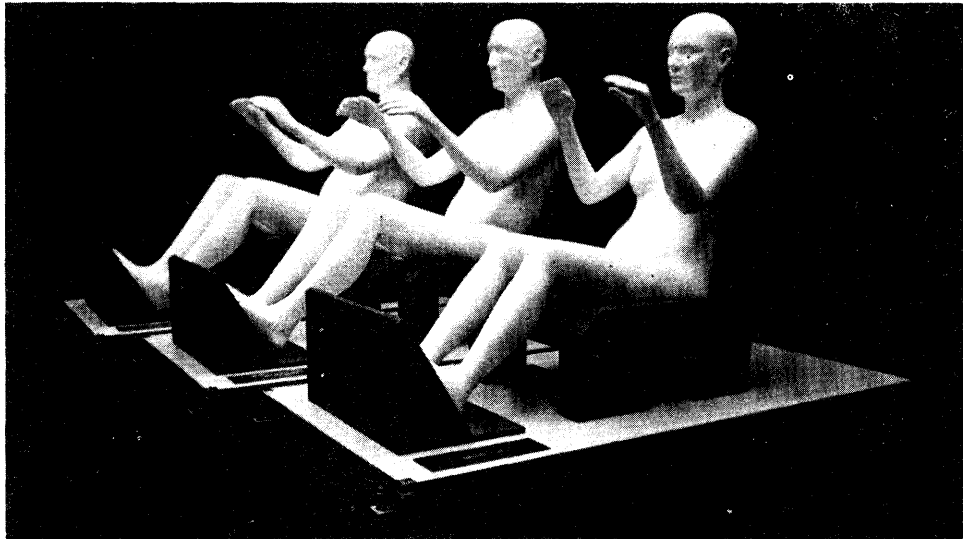


FIGURE 4-21. Completed seat assemblies with shells for the three dummy-family members.

5.0 DEVELOPMENT OF ANTHROPOMETRIC SPECIFICATION PACKAGE

5.1 Introduction

The purpose of this section is to present the anthropometric specifications for the three-member dummy family. Data gathered during the project as well as data available in the literature were used in formulating these specifications. The analytical techniques and procedures used in combining the various data resources are summarized.

The background information for Section 5 is contained in Section 3 of the report as well as Volumes 2 and 3. The first of these describes the procedures used in obtaining average anthropometric data for use in defining a seated dummy. The others describe the published data resources used in definition of body segmentation, mass, and joint characteristics, and contain the details of the computations.

Section 5 is organized not only to present the results but to lead the user through the process of development of a consistent anthropometric description of a seated human. The first subsections concentrate on subject geometric definition based on measured surface landmarks and the construction of a standard seat coordinate system in which all data can be specified. In the next subsections, the emphasis shifts to division of the body into discrete segments. This implies, when the user of these data shifts to dynamic applications such as crash test dummies, at least the partial acceptance of the major mechanical assumption that the human body can be represented as a chain of rigid bodies. (In the static sense, when the body is not moving, this assumption is valid.) Individual coordinate systems are then defined for each segment. Transformations are developed that relate these segment systems to the standard seat coordinate system. Mathematical formulations follow for the construction of segmentation planes between the various parts of the body. The static anthropometric description is completed by estimation of joint center locations for the seated subject in both standard seat and segment coordinate systems. Finally, joint range of motion is discussed.

Throughout this section, the subscripts L, H, and A on coordinate axes X, Y, and Z refer to the laboratory, the whole body or H-point, and the anatomical or body segment coordinate systems, respectively.

Section 5 is supplemented by full-size blueprints showing side, front, and top views of the following:

- Surface landmarks
- Joint centers
- Segment centers of gravity
- Origins of segment coordinate systems
- Surface profile of actual surface form
- Information on anatomical and principal axes
- Information on segmentation planes

The drawing numbers are given below:

<u>Drawing</u>	<u>Mid-Sized Male</u>	<u>Small Female</u>	<u>Large Male</u>
Side View	MM-101	SF-201	LM-301
Front View	MM-102	SF-202	LM-302
Top View	MM-103	SF-203	LM-303

Two additional drawings, MM-104 and MM-105, contain front and side views as above with a superimposed skeletal rendering. Figure 5-1 is a schematic showing a subset of this information. The tables of data which are referred to in the text are at the end of Section 5.

5.2 Landmarks Used for Subject Definition

In order to develop a geometric and mass definition of a person seated in an automobile, it is necessary to take into account a variety of issues including:

- Body segmentation scheme
- Sizing of components
- Segment masses
- Segment centers of gravity
- Segment moments of inertia
- Joint locations
- Joint ranges of motion
- Surface geometry
- Orientation of pelvis, vertebral column, skull, and lower extremities in the seated posture
- Relation of coordinate systems in anatomical segments to

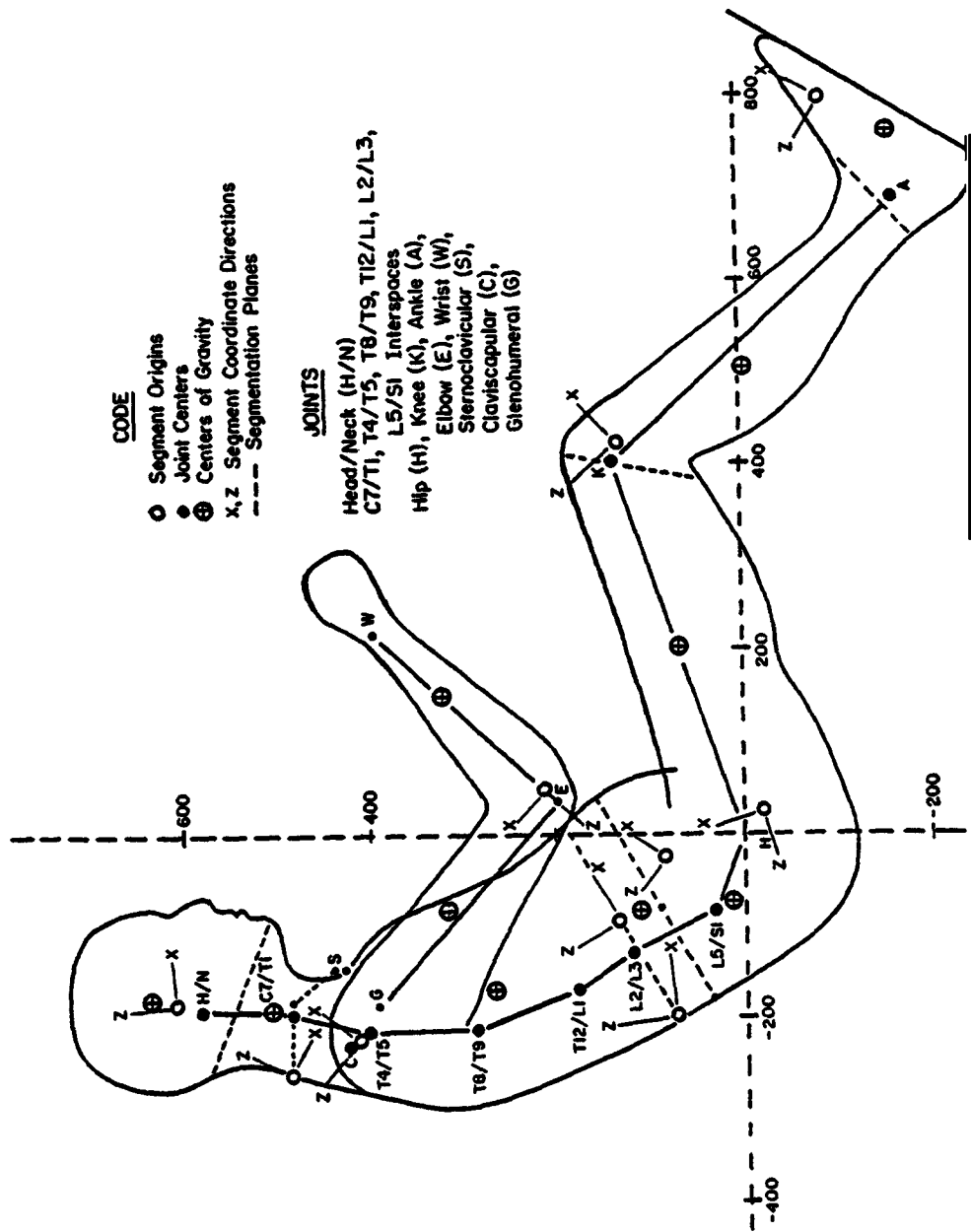


FIGURE 5-1. Anthropometric specifications for mid-sized male dummy.

the standard seat coordinate system

Table 5.1 is the original minimum collection of geometric points estimated to be required. The first thirty-one of these are minimum requirements for body segmentation, mass property definition, and segment coordinate system construction using the formulae and techniques of McConville et al. (1980). Tables 5.2 and 5.3 associate particular skeletal landmarks used in the present analysis with coordinate systems and segmentation planes. The large majority of these agree with the first thirty-one of Table 5.1. However, a few new points can be identified which are required for the study of seated posture. These include:

- Thorax and abdomen coordinate systems as well as segmentation plane: "Intersection point on the back of surface form of a perpendicular from the center of a line connecting the 10th rib targets to a line connecting the T12 and L5 surface targets."
- Foot coordinate system: "Heel point" (taken directly from the seating buck).
- Abdomen segmentation plane: "Intersection point on back of surface form of a perpendicular from the center of a line connecting the iliocristale targets to a line connecting the T12 and L5 surface targets."
- Hip segmentation plane: "Pubotuberosity" and "lateral tuberosity point."

Beyond the first thirty-one, the next three landmarks locate the position of the scapula within the space defined by a shoulder girdle mass, which is separate from the thorax or chest mass defined by McConville et al. Although it has not been possible within the current activity, it is recommended that in future work the cadaver shoulder girdle segmentation scheme and mass data of Dempster (1965) be used to decompose the thorax definition of McConville et al. into rib cage and shoulder girdle segments. The recognition of the separation of rib cage from shoulder girdle will lay the basis for design of more realistic interactions between members of the new dummy family and side-door structures as well as frontal restraint devices. A further purpose is to more clearly define the location of the acromio-clavicular and glenohumeral joints so that the best possible estimates of shoulder girdle centers of rotation can be made.

The final five surface landmarks relate to the spinal column. These data were used as input for procedures reported by Snyder et al. (1972) to define the location of several spinal interface centers with respect to the surface landmarks. These landmarks are important for placing the vertebral column in a correct relationship to the exterior of the surface form.

Four of the surface landmarks in Table 5.1 require special comment. These are marked by asterisks. The symphysis was replaced in the final list of subject targets by pelvic crest due to the difficulty of target location for photographic data acquisition. In order to compensate, a correction factor was developed to translate pelvic crest landmark to symphysis based on pelvic geometry data of Reynolds et al. (1981). The posterior calcaneus is hidden from view in that the heel is in the driving position in the standard seat buck. However, a close approximation of this point is the heel point reference that is measured directly on the buck.

It was not possible to obtain two points directly. These are nuchale and gluteal furrow. However, nuchale position can be inferred from the surface form and by the fact that its location is given in anatomical coordinates by McConville et al. (1980). Gluteal furrow point is in contact with the seat and hence is invisible.

5.3 Development of Standard Seat Coordinate System

The selection of a standard seat coordinate system was made between two candidates: (1) traditional H-point, and (2) seat-based coordinate system. The traditional H-point represents a point on the H-point machine associated with the human hip joint. Seat-based coordinate systems often reflect the intersection point between seat back and seat cushion lines. The continuous curvature of the seat back and cushion of the average standard seat developed on this project prevented development of any clear definition of seat back and seat cushion lines. Hence, it was decided that the traditional H-point concept offered the better alternative.

Surface landmarks (right and left anterior-superior iliac spines as well as pelvic crest) were available for orientation of the pelvis in

three-dimensional coordinates. In order to define the H-point location it was necessary to estimate tissue thicknesses of the surface landmarks over the corresponding bony points on the pelvis. Based on these estimates (see Volume 3), it was then possible to orient the pelvis in space if an appropriate average structure could be found.

The data of Reynolds et al. (1981) are based on subject groups similar in average stature and weight to those measured during the current study. These data were accepted for the pelvic reconstruction, location of the standard seat coordinate system at the center of a line connecting the H-points, location of the center of rotation of the two hip joints, and location of the lumbar-sacral (L5/S1) joint center.

The direction of the Reynolds et al. coordinate system was superimposed upon the UMTRI data for anterior-superior iliac spine (ilio-spinale summum) and pubic symphysis (Figure 5-2). The direction angle, (θ) between the two, allowed conversion of any of the Reynolds et al. data points into a system parallel to the UMTRI lab system with an origin at the center point of the anterior-superior iliac spines using the simple transformation

$$X_L = X_R \cos \theta - Z_R \sin \theta$$

$$Z_L = X_R \sin \theta + Z_R \cos \theta$$

where the subscript R identifies the Reynolds et al. coordinate values. The following points were transformed as needed for use in construction of joint centers, segmentation planes, anatomical segment axes estimation of tissue depths, etc.:

- H-points
- Pubic symphysis
- Inferior symphyseal pole
- Superior pole, pubic symphysis
- Ilio-spinale summum
- Ilio-cristale summum
- Inferior tuberosity point
- Posterior point on 1st sacral vertebral body
- Promontorion
- Lateral point on 1st sacral vertebral body
- Pubotuberosity
- Lateral tuberosity point

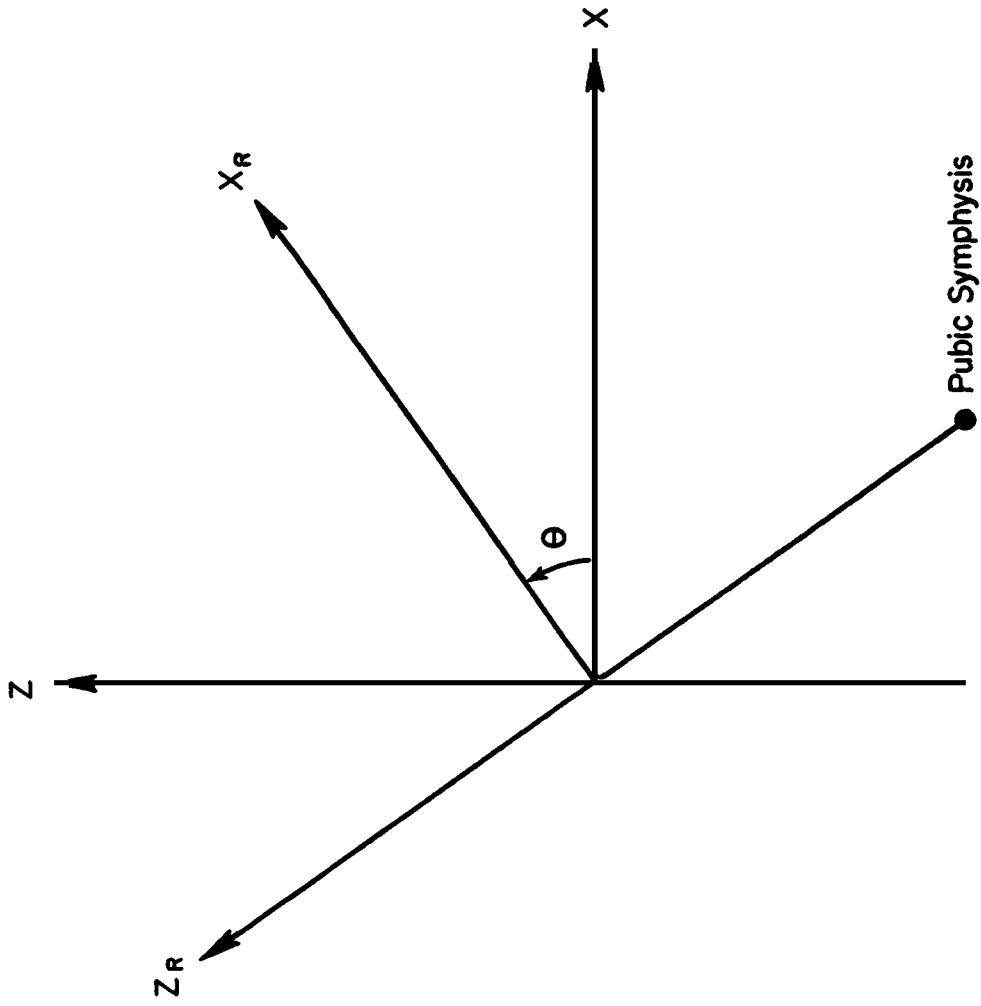


FIGURE 5-2. Pelvic coordinate system superimposed on UMTRI lab-based coordinate system.

The key points for development of standard seat coordinate systems for the three surface forms were the H-points which, when referred to the original UMTRI laboratory coordinate systems, are located as follows:

<u>Surface Form</u>		<u>X_L (mm)</u>	<u>Y_L (mm)</u>	<u>Z_L (mm)</u>
Small Female:	Left	755	699	425
	Right	755	539	425
Mid-Sized Male:	Left	657	701	422
	Right	657	537	422
Large Male:	Left	618	705	409
	Right	618	533	409

The Y_L shifts from the body centerline were ±80, 82, and 86 mm as reported by Reynolds et al. The centers of the lines connecting these two points are located as follows:

<u>Surface Form</u>	<u>X_L (mm)</u>	<u>Y_L (mm)</u>	<u>Z_L (mm)</u>
Small Female	745	619	425
Mid-Sized Male	657	619	422
Large Male	618	619	409

These points have been selected as the origins of the standard seat coordinate systems. All further data in Section 5 of this report are related to this point on the body centerline.

5.4 Subject Data Translated to Standard Seat Coordinate System

Table 5.4 presents all skeletal and surface landmarks used in the development of the anthropometric specifications for the three members of the dummy family and which are incorporated in the surface forms. The origin of coordinates is the center of a line connecting the H-points.

5.5 Segmentation and Linkage Selection

The traditional segmentation of the human body for use in developing crash test device linkages is as follows:

Head	Two Lower Legs
Neck	Two Feet
Thorax	Two Upper Arms
Abdomen	Two Lower Arms
Pelvis	Two Hands
Two Upper Legs	

Although substantial mobility in the shoulder girdle has been known for years (see Dempster 1965, Dempster and Gaughran 1967, and Snyder et al. 1972), only minimal data are available for the description of its mass and inertial properties. Dempster (1965) reports a center of gravity, mass, and inertial properties around the side-to-side axis (Y-axis) for the masses associated with scapula, clavicle, and soft tissues exterior to most of the bony thorax. No shoulder girdle data are given in the more recent work of McConville et al. (1980) and Reynolds et al. (1975). As a result, it was concluded that insufficient consistent data are available from the literature to construct a separate shoulder girdle within the scope of the current activity.

A non-traditional segmentation scheme is recommended for the eventual advanced dummy family that includes a separate, mobile shoulder girdle link and the associated mass. Sufficient surface landmarks are available in the UMTRI data (scapula, clavicle, extent of rib cage) to define this segmentation. Mass, center of gravity, and inertial properties could be measured directly from a solid casting of the surface form shoulder girdle after separation from the thorax. Similarly, it is expected that a related mathematical procedure could be used to separate thorax from shoulder in the McConville et al. (1980) data.

In conclusion, the traditional segmentation and linkage system has been adopted as the only one feasible based on available data. It has been simplified slightly by coupling hand and lower arm masses, although the location of the wrist joint is specified. This linkage arrangement will be assumed throughout the remainder of Section 5.

5.6 Construction of Segmentation Planes

The construction of segmentation planes is based largely upon the scheme used by McConville et al. (1980) in their determination of anthropometric relationships of body and body segment moments of inertia. The constructions are modified somewhat to account for differences between body segment relationships in the seated and standing postures. The points required for construction of the planes are given in Table 5.3. Details of the computations are given in Volumes 2 and 3 for the three family members. The results are summarized in Table 5.5. It should be noted that these formulae can be used to determine the intersection of the plane with the surface form at points other than surface landmarks used in the definitions. A discussion of special problems in segmentation plane construction follows.

The thorax and abdomen segmentation planes, shown in Figure 5.3, presented special problems. The McConville et al. definition specifies that the thorax plane originates at the tenth rib mid-spine landmark and passes through the torso parallel with the standing surface. In order to approximate this plane in the seated posture, a line was constructed from the tenth rib landmark that was perpendicular to a line connecting the T12 and L5 surface landmarks. This line, which is roughly perpendicular to the body centerline, is intended to separate the thorax, which has a bony skeletal periphery, from the abdomen which has a soft tissue periphery. In dynamic applications, thorax and abdomen will have very different stiffnesses and are coupled very differently to the bony skeleton.

For the abdomen, the McConville et al. definition specifies that the plane "originates at the iliocristale landmarks and passes through the torso parallel with the standing surface." This plane presents a dilemma even more complex than the thorax. Because of the spinal tilt due to the seated posture, it would seem logical to develop a segmentation scheme similar to that used for the thorax.

However, on the basis of the physical nature of the abdomen mentioned above, it would make more sense to define a scheme that better delineates the extent of the soft abdomen. A pair of new planes are

CODE

JOINTS (T12/L1, L2/L3, L5/SI, HIP)

T12 - T12 LANDMARK

L2 - L2 LANDMARK

R10 1 - POINT ON SURFACE FROM R10

I 1 - POINT ON SURFACE FROM ILIOCRISTALE

L5 - L5 LANDMARK

R10 - 10th RIB LANDMARK

I - ILIOCRISTALE LANDMARK

U - UMBILICUS LANDMARK

M - MAXIMUM ABDOMINAL PROTRUSION

ASIS - ANTERIOR SUPERIOR ILIAC SPINE

TH - THORAX SEGMENTATION PLANE

AB - ABDOMEN SEGMENTATION PLANE

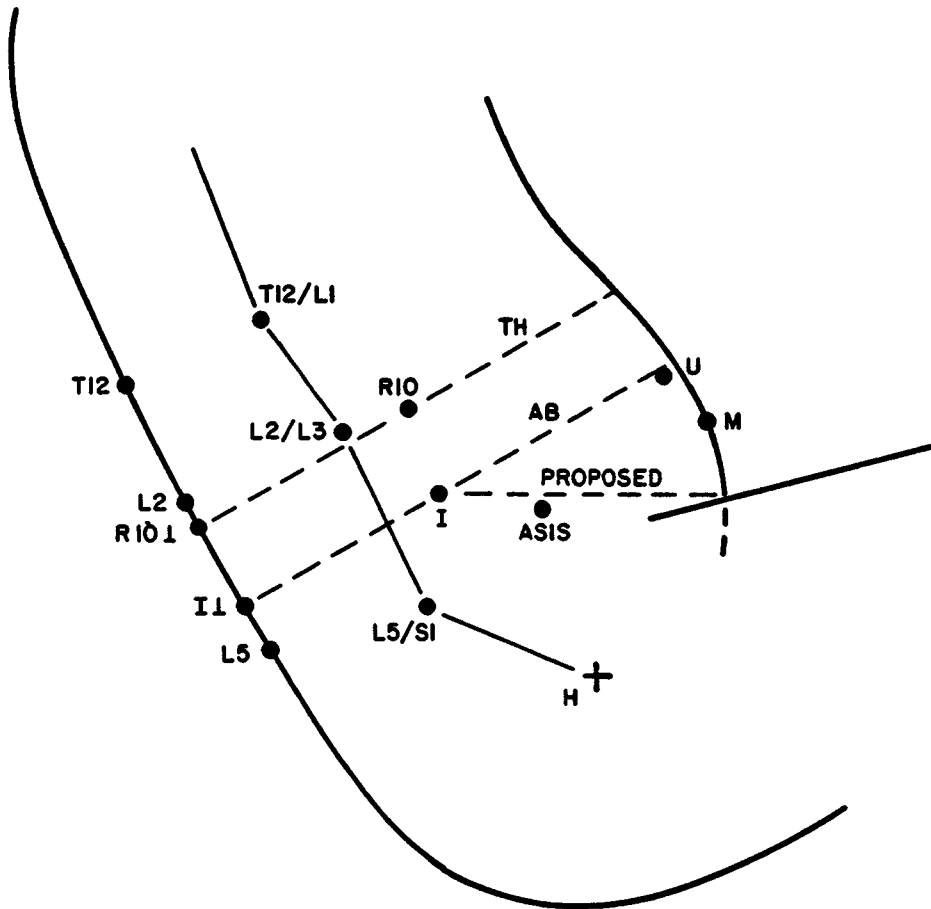


FIGURE 5-3. Construction of thorax and abdomen segmentation planes.

proposed, the first of which angles backward from the iliocristale landmarks perpendicular to the same line connecting the T12 and L5 surface landmarks used in constructing the thorax plane (see Figure 5-3). The second plane is horizontal and extends from the iliocristale target to the front of the body. The region of maximum abdominal protrusion is included in this definition. This plane passes just above the anterior-superior iliac spine targets.

Two more observations on the McConville et al. data conclude the information required for making a final decision on the abdomen segmentation plane. The first is that the distance between the thorax and abdomen planes, which are parallel, is similar to the distance from the iliocristale landmark to the thorax segmentation plane developed from the UMTRI data. The second is that the data that are available for mass and inertial properties apply only to the parallel planes through the iliocristale and tenth rib landmarks.

The conclusion was to present data based on a segmentation plane parallel to the thorax plane and recommend that new inertial and mass properties be developed based on the proposed definition given above and illustrated in Figure 5-3.

For the pelvis segmentation, McConville et al. (1980) specified a plane that "originates at the center of the crotch. . . ." The lack of a similar point in the current data set led to selection of a new set of points that met the objective of separating the upper leg region from the bony pelvis. The four points--anterior-superior iliac spines, pubotuberosity, lateral tuberosity point, and inferior tuberosity point--were used in a process that generates a plane nearly through the H-points and which does not remove pelvic bone.

For the knee, the McConville et al. definition specifies that the plane "passes through the lateral femoral epicondyle landmark parallel to the standing surface." Because of the difference between the standing and seated postures, this definition is not realistic. As an alternative, designed to separate the upper and lower leg masses, a plane through the lateral femoral epicondyles bisecting the angle in the $X_L Z_L$ plane made by the lines connecting the upper and lower leg links, was used.

In the case of the ankle, the McConville et al. definition specifies that the plane "originates at the sphyrion landmark and passes through the ankle parallel to the standing surface." This plane is maintained fairly well by constructing a plane through the sphyrion, parallel to the Y_H axis, and perpendicular to a line projected into the $X_H Z_H$ plane connecting the knee and ankle joints.

5.7 Development of Anatomically Based Segment Coordinate Systems

This section summarizes the anatomically based coordinate systems for each of the various segments of the body. The coordinate systems that have been constructed are the same, or very similar to, those that have been reported by McConville et al. (1980) in developing anthropometric relationships of body and body segment moments of inertia. As such, they are used directly in the presentation of center of mass and inertial data and provide the linkage between the coordinate systems defining the principal axes of inertia and the standard coordinate system at the H-point center.

In order to construct coordinate systems and relate them to the standard system, it was necessary in general to know three points in each segment. For the present analysis, the following three were used for the most part: (1) one at the origin, (2) one on an axis, and (3) one in one of the orthogonal planes. The points used for each system are defined in Table 5.2. Data used are given in Table 5.4. Locations of the origins of segment anatomical coordinate systems for the three members of the dummy family are shown in Table 5.6. Table 5.7 gives cosine matrices expressed in degrees for all anatomical axis systems with respect to the hip point axis system. Details of computation are given in Volumes 2 and 3.

5.8 Volume, Mass, and Inertial Properties

To compute segment volumes (and masses) the regression equations given in McConville et al. (1980) were used for the mid-sized and large male dummies. Similar equations for the small female were obtained from a report by Young et al. (1983). The predicted volumes and the sum of

volumes for the whole body are given in Table 5.8 for the three family members. The values obtained for the left and right sides of the body have been averaged. These volume calculations are based on a density assumption of 1.0 gm/cm^3 . Using this value for density, the resulting total body weights would be overestimated by the following:

Mid-Sized Male	=	4.6 percent
Large Male	=	5.4 percent
Small Female	=	3.0 percent

If a density value of 0.92 (see Dempster 1955) is used for the thorax, the predicted values for weight are much closer to subject means. Because of the apparent overestimation, scaling factors were used to yield body segment weights which, when summed, yielded the correct value. Table 5.8 also includes the estimated body segment weights.

McConville et al. (1980) and Young et al. (1983) also give data on center of volume for the various segments of the body. The assumption was made that center of mass and center of volume are coincident. It is known that this assumption is not completely correct because of density variations within segments. Clauser et al. (1969) note that mid-volume of limb segments are proximal to centers of mass. The differences, however, are small and believed to be insignificant in comparison with other possible errors. The greatest of these is the mobility of soft tissues with respect to the bony skeleton as the body moves either voluntarily or especially under impact loading. For the current static case of seated posture, and for applications where the assumption of an articulated linkage of rigid masses is valid, the forestated assumption is believed to be adequate. However, if these data are to be used for dynamic applications where there is loose coupling between soft tissue and bony skeleton, the assumption should be questioned and substitute data gathered where necessary. To the knowledge of the authors, there are no substantive published data available to address this issue for automotive applications. Table 5.9 gives the locations of estimated centers of gravity with respect to the whole body coordinate system. Table 5.10 gives these points with respect to the individual segment coordinate systems.

To compute the inertial properties, the data and regression equations of McConville et al. (1980) and Young et al. (1983) were again used. The resulting values are summarized in Table 5.11. Again, a scale factor based on the overestimation of volume is used. Also, values for the left and right sides of the body are averaged. Details of the computations are included in Volumes 2 and 3.

The principal axes of inertia for each segment have been computed by both McConville et al. and Young et al. with respect to segment anatomical coordinate systems. In the present study, these transformations were modified slightly to reflect the body symmetry assumption. Tables 5.12 and 5.13 present the principal axes with respect to both anatomical and H-point axis systems.

In order to provide input to the regression equations, the basic anthropometric properties of each segment were considered. The McConville et al. (1980) and Young et al. (1983) subjects were measured in a standing position. The current study included traditional standing anthropometric measurements as well as seated measurements. Finally, the profile of the surface forms was digitized (see Volumes 2 and 3 for the resulting data). These various resources were reviewed in detail to assure that suitable and comparable input quantities were used in the regression equations.

5.9 A Model for the Location of Joint Centers

In order to quantify motions of one segment with respect to its neighbors in a linkage, it is necessary to define the connections between the elements in the linkage. Connections between elements of the bony skeleton are called articulations. If the position of the articulation coincides with a point about which rotations between neighboring bony segments can occur, it is called a center of rotation or joint center.

Joints in the human body most often exhibit more than one degree of freedom in describing the motion of one body segment with respect to its neighbors. Some, such as the knee and elbow, can probably be modeled as pins connecting the upper and lower arms and legs. However, it is known that the motions at these joints are more complex and

involve a small amount of migration of the joint location within each of the neighboring segments as the body moves (see Dempster 1955). Others, such as the hip, ankle, and glenohumeral joints, are more like ball connections between the two segments.

The shoulder girdle is even more complex in that it is composed of three articulations--the glenohumeral, sternoclavicular, and acromioclavicular articulations. The glenohumeral articulation consists of the humeral head rotating on the glenoid fossa. As there is very little movement of the center of the humeral head with respect to the scapula in normal motion, this articulation can properly be called the glenohumeral joint. The sternoclavicular articulation has many properties of a ball joint, while the acromioclavicular articulation combines with the conoid and trapezoid ligaments to form the claviscapular joint system, which has also been discussed by Dempster (1955). These joints are supplemented by a moveable shoulder girdle mass, separate from the thorax, which rides with the scapula. The three joints, combined with the clavicle and scapula mass links, define the mobility of the arm with respect to the torso.

The vertebral column is actually a collection of seven cervical, twelve thoracic, and five lumbar vertebrae. In each articulation between the vertebrae there is the possibility of limited rotation, shear, and stretching. Two concepts have been used in the construction of cervical spines for crash test dummies, such as the Hybrid III (see Foster et al. 1977), and crash victim computer codes, such as the MVMA 2D model (see Bowman et al. 1979) and the various versions of the Calspan CVS. In the case of the dummy, the cervical spine is a deformable element connecting head to torso. The model lumps the rotational properties into head/neck and neck/thorax interface joints and uses an extensible neck link between the joints. Both concepts are simplifications of the actual vertebral structure that ignore coupling between the three possible rotational modes at the various articulations (flexion, lateral flexion, and rotation) as has been discussed by Bowman and Robbins (1972) and Schneider et al. (1975). This coupling is believed to exist for all lumped joint models of the vertebral column.

The thoracic vertebrae are usually assumed to be immobile with respect to each other in similar dummy and modeling applications. Studies such as the torso link mobility study by Snyder et al. (1972) and the spinal mobility study by Cheng et al. (1979) contradict each other as to the need for upgrading this model. The torso link study, which is a reach study and does not involve dynamic loading, identified substantial mobility throughout the spine from neck to pelvis. The Cheng study has gone so far as to suggest a rigid link from the C7/T1 to the lumbar sacral joint for use in a frontal impact dummy. It is clear that considerable work and discussion must take place before the definitive selection of the appropriate number of spinal joints and the linkage between them can be made.

The lumbar spine is usually considered as a flexible element in dummy hardware. Alternatively, the mobility is concentrated at two joints representing connections to the pelvis and thorax. Data are very limited and incomplete, especially for non-frontal dynamic mobility, regarding both location and compliance for this joint model.

Joint center models for the seated occupant were derived using information from many sources. The details are included in Volumes 2 and 3. A summary of the joint locations is given in Table 5.14. The derivations for the mid-sized male were carried out first. These results were then scaled for the large male and small female based on the detailed anthropometric data available.

5.10 Joint Parameters

Two basic types of parameters were considered in the development of joint parameters. The first of these is an identification of the range of mobility between different segments of the body. The second is the resistance to motion when one segment of the body moves with respect to its neighbors.

The normal range of mobility of the body is usually described as joint range of motion data. The most commonly used sources are Dempster (1955), Barter et al. (1957), and Glanville and Kreezer (1937). References with particularly extensive data on neck mobility have been prepared by Ferlic (1962) and Snyder et al. (1975a, 1975b). Thoracic

and lumbar spine mobility data have been reported by Nyquist and Murton (1975), as well as Mital et al. (1978, 1979) and Krieger (1976). Response of the human neck has been reported by Mertz and Patrick (1971) as well as Ewing and Thomas (1972, 1973). Additional extensive range of motion data on head/neck flexion, extension, lateral flexion, rotation, and combined modes are expected in the near future from the Ewing and Thomas team. Table 5.15 is an assemblage of range of motion data while Figure 5-4 illustrates the range-of-motion definitions.

Data on resistance to motion are very much more difficult to find, interpret, and assemble into a form usable in dummy design work. The most directly applicable data have been reported for the:

- Neck by Mertz and Patrick (1971), Snyder et al. (1975a, 1975b), and Robbins et al. (1974)
- Head/trunk, waist, hip, knee, shoulder, elbow by Krieger (1976)
- Lower spine by Nyquist and Murton (1975) and Mital et al. (1978, 1979)
- Shoulder, arms, and legs by Engin (1979, 1980, 1981), Engin and Kaleps (1980), and Engin and Kazarian (1981)

Further details are included in Volumes 2 and 3.

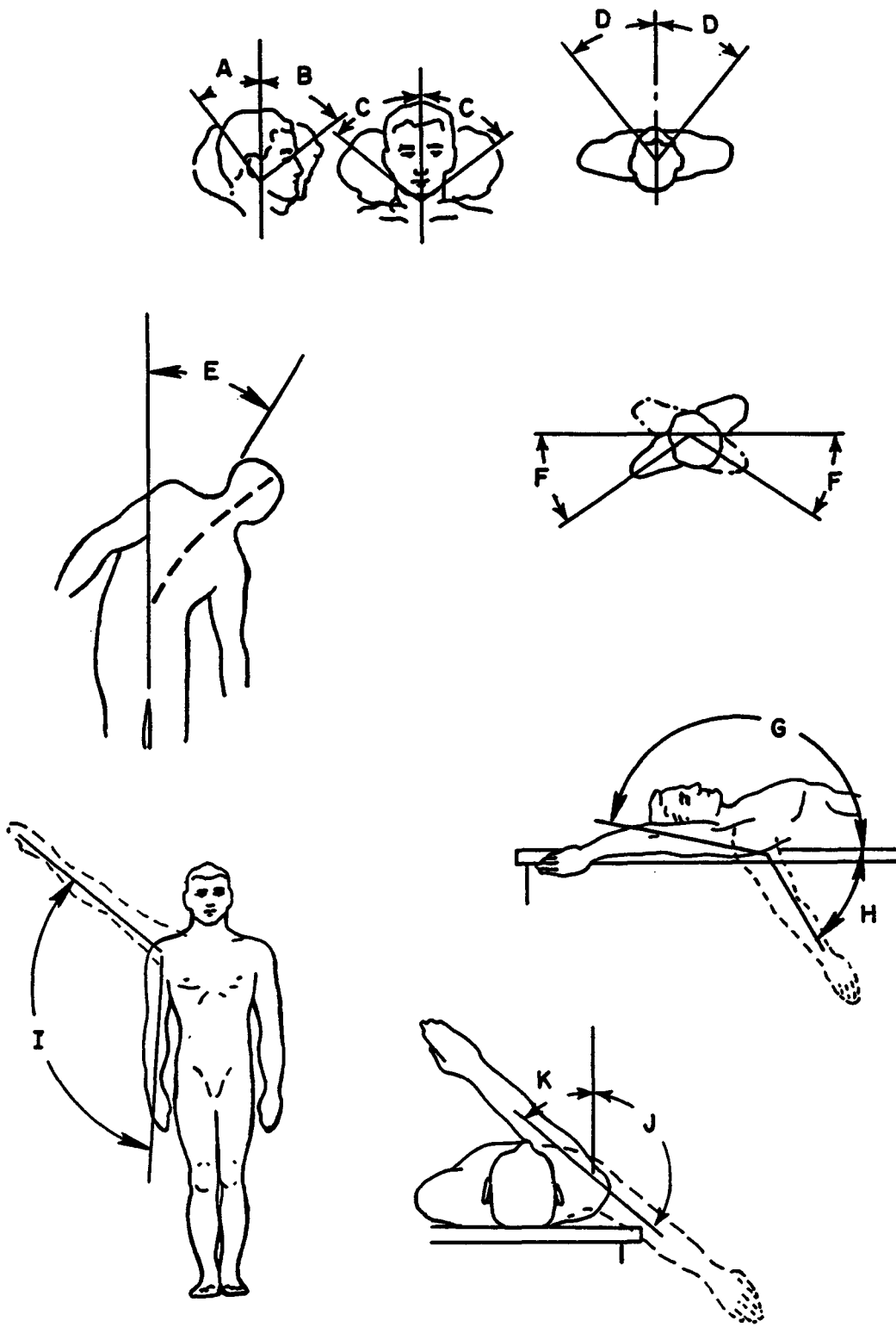


FIGURE 5-4. Illustrations of range-of-motion definitions (1 of 4).

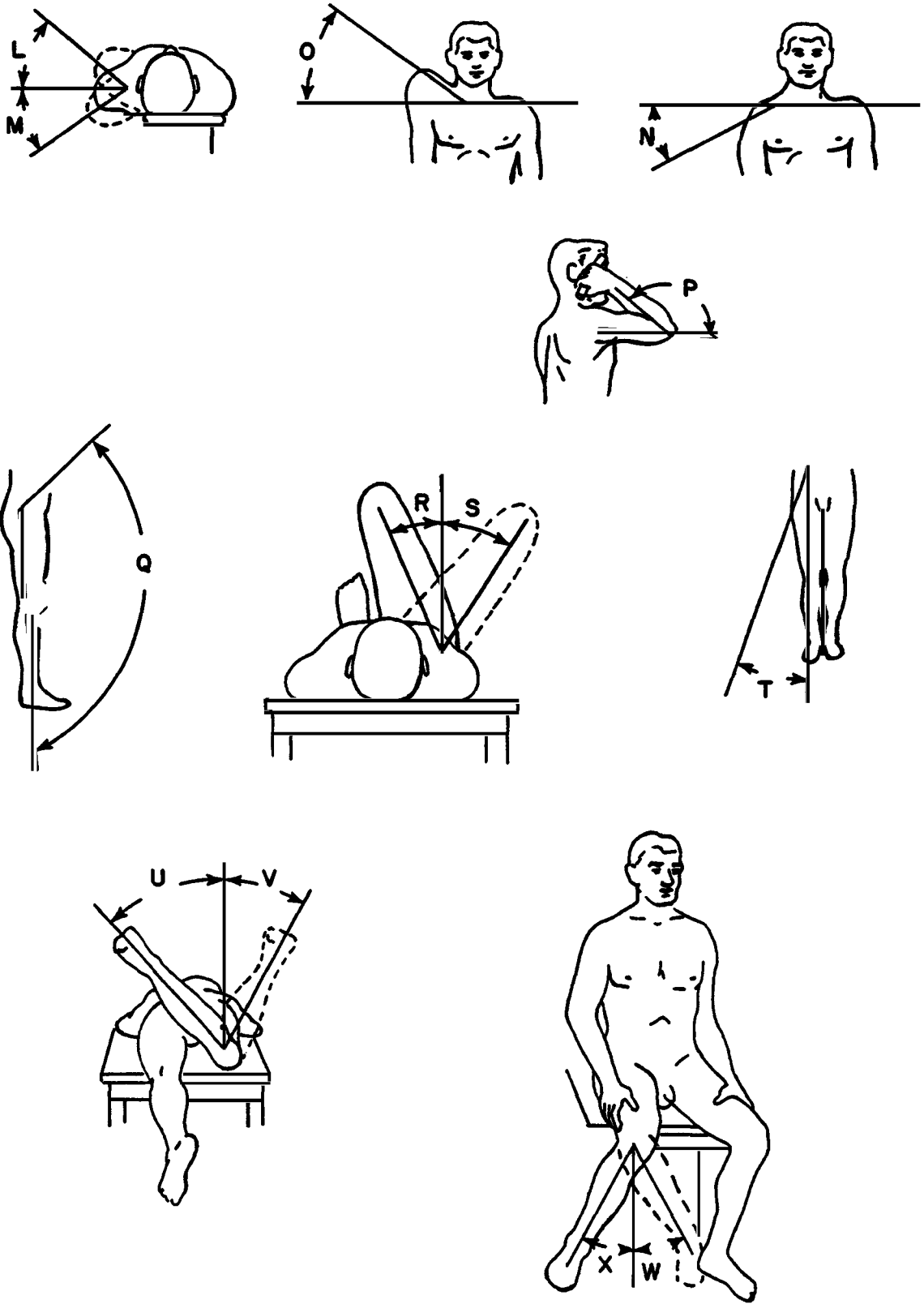


FIGURE 5-4. Illustrations of range-of-motion definitions (2 of 4).

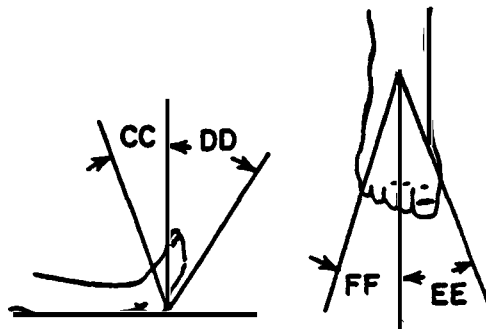
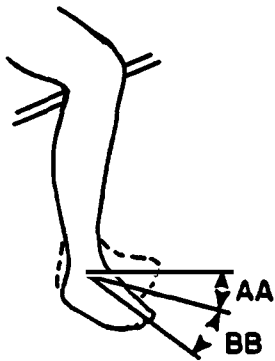
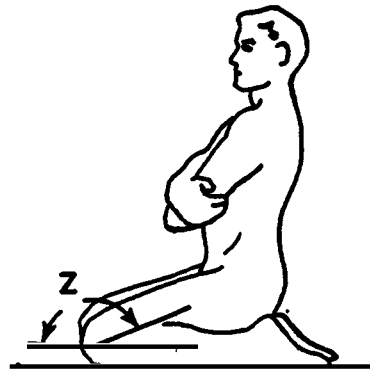
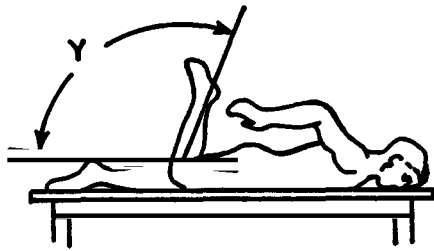


FIGURE 5-4. Illustrations of range-of-motion definitions (3 of 4).

Range-of-Motion Illustration Code

A - Head dorsal flexion (hyperextension)
B - Head ventral flexion
C - Head lateral flexion
D - Head rotation
E - Torso lateral flexion
F - Torso rotation about long axis
G - Shoulder flexion (sagittal plane) (3 links)
H - Shoulder extension (sagittal plane) (3 links)
I - Shoulder abduction (coronal plane) (3 links)
J - Shoulder abduction (transverse plane) (3 links)
K - Shoulder adduction (transverse plane) (3 links)
L - Shoulder protraction (transverse plane) (clavicle)
M - Shoulder retraction (transverse plane) (clavicle)
N - Shoulder depressed (coronal plane) (clavicle)
O - Shoulder shrugged (coronal plane) (clavicle)
P - Elbow flexion
Q - Hip flexion
R - Hip abduction (transverse plane)
S - Hip adduction (transverse plane)
T - Hip abduction (coronal plane)
U - Hip medial rotation (prone)
V - Hip lateral rotation (prone)
W - Hip medial rotation (sitting)
X - Hip lateral rotation (sitting)
Y - Knee voluntary flexion (prone)
Z - Knee forced flexion (kneeling)
AA - Knee medial rotation
BB - Knee lateral rotation
CC - Ankle dorsiflexion
DD - Ankle plantar flexion
EE - Ankle inversion
FF - Ankle eversion

FIGURE 5-4. Illustrations of range-of-motion definitions (4 of 4).

TABLE 5.1

LIST OF SURFACE LANDMARKS FOR SEGMENT AND JOINT DEFINITION
(Original Requirements)

1.	Cervicale*
2.	Acromion
3.	Trochanterion (skeletal reconstruction)
4.	Infraorbitale
5.	Tragion
6.	Suprasternale
7.	Lateral Humeral Epicondyle
8.	Ulnar Styloid
9.	Anterior-Superior Iliac Spine
10.	Symphysion**
11.	Lateral Femoral Epicondyle
12.	Lateral Malleolus
13.	Clavicale
14.	Mid-Spine, 10th Rib Level
15.	Lateral 10th Rib
16.	Medial Humeral Epicondyle
17.	Radiale
18.	Stylian
19.	Medial Femoral Epicondyle
20.	Tibiale
21.	Sphyrion
22.	Metatarsal/Phalangeal I
23.	Metatarsal/Phalangeal V
24.	Posterior Calcaneus**
25.	Tip of Digit II (Toe)
26.	Gonion
27.	Iliocristale
28.	Anterior Scye
29.	Olecranon
30.	Nuchale**
31.	Gluteal Furrow (most inferior point)**
32.	Superior Margin Scapula
33.	Inferior Margin Scapula
34.	Acromio-Clavicular Articulation
35.	T4 Surface
36.	T8 Surface
37.	T12 Surface
38.	L2 Surface
39.	L5 Surface

*See Section 3.0 for definitions.

**Landmarks modified or deleted from final list.

TABLE 5.2

LANDMARKS USED IN CONSTRUCTION OF SEGMENT
ANATOMICAL COORDINATE SYSTEMS

Segment	Landmarks
Head	Tragion (L and R) Infraorbitale (L)
Neck	Clavicale (L and R) Cervicale
Thorax	Cervicale 10th rib (L and R) Intersection point on back of surface form of a perpendicular from the center of a line connecting the 10th rib targets to a line connecting the T12 and L5 surface targets T12 L5
Abdomen	10th rib (L and R) Intersection point on back of surface form of a perpendicular from the center of a line connecting the 10th rib targets to a line connecting the T12 and L5 surface targets T12 L5
Pelvis	Anterior-Superior Iliac Spines (L and R) Symphision
Upper Arms	Acromion (L and R) Medial Humeral Epicondyle (L and R) Lateral Humeral Epicondyle (L and R)
Lower Arms and Hands	Radiale (L and R) Ulnar Styloid Process, Distal End (L and R) Radial Styloid Process, Distal End (L and R)
Upper Legs	Trochanterion, reconstructed (L and R) Lateral Femoral Epicondyle (L and R) Medial Femoral Epicondyle (L and R)
Lower Legs	Tibiale (L and R) Sphyrion (L and R) Lateral Malleolus (L and R)
Feet	Metatarsal/Phalangeal I (L and R) Metatarsal/Phalangeal V (L and R) Heel Point (L and R)

TABLE 5.3

LANDMARKS USED IN CONSTRUCTING SEGMENTATION PLANES

Segmentation Plane	Landmarks
Head	Gonion (L and R) Nuchale
Neck	Clavicale Cervicale
Thorax	10th Rib (L and R) Intersection point on back of surface form of a perpendicular from the center of a line connecting the 10th rib targets to a line connecting the T12 and L5 surface targets
Abdomen	Iliocristale (L and R) Intersection point on back of surface form of a perpendicular from the center of a line connecting the iliocristale targets to a line connecting the T12 and L5 surface targets
Hip	Anterior-Superior Iliac Spine (L and R)* Pubotuberosity (L and R)* Lateral Tuberosity Point (L and R)*
Knee	Lateral Femoral Epicondyle (L and R)
Ankle	Sphyrion (L and R)
Shoulder	Acromion (L and R) Anterior Scye (L and R) Posterior Scye (L and R)
Elbow	Olecranon Medial Humeral Epicondyle Lateral Humeral Epicondyle

*These skeletal landmarks are derived from the position in space of the average pelvis (Reynolds et al. 1981).

TABLE 5.4
SURFACE LANDMARKS RELATIVE TO H-POINT (in mm)

Body Segment	Surface Landmark	SMALL FEMALE			MID-SIZED MALE			LARGE MALE		
		X _H	Y _H	Z _H	X _H	Y _H	Z _H	X _H	Y _H	Z _H
Head	Glabella	- 90	0	578	- 80	0	651	-111	0	684
	Infraorbitale	-103	± 32*	550	- 96	± 34	620	-128	± 37	650
	Tragion	-180	± 67	545	-185	± 83	614	-212	± 83	646
	Gonion	-167	± 55	484	-173	± 70	544	-195	± 70	576
	Gnathion	- 91	0	465	-101	0	511	-108	0	555
	Nuchale**	-247	0	517	-262	0	579	-293	0	612
Torso	Suprasternale	-144	0	391	-139	0	435	-162	0	459
	Mesosternale	-110	0	353	- 98	0	385	-119	0	415
	Substernale	- 89	0	316	- 72	0	336	- 89	0	364
	Nipple	- 39	± 85	250	- 52	±113	290	- 59	±132	320
	10th Rib, anterior, midline	- 10	0	150	15	0	191	33	0	218
	Umbilicus	1	0	141	35	0	153	60	0	172
	Maximum Abdominal Protrusion	22	0	129	56	0	129	75	0	153
	10th Rib	- 96	±129	125	- 93	±156	133	-126	±194	143
	C7	-238	0	445	-266	0	489	-300	0	531
	T4	-259	0	364	-293	0	380	-333	0	421
Vertebral Column	T8	-247	0	242	-284	0	253	-327	0	284
	T12	-200	0	122	-246	0	146	-283	0	155
	L2	-180	0	79	-217	0	87	-246	0	95
	L5	-154	0	23	-174	0	13	-202	0	19
	Mid-Spine 10th Rib	-201	0	126	-242	0	138	-277	0	144
	R10 to back perpendicular**	-183	0	85	-209	0	71	-237	0	77
	Iliocristale to back perpendicular**	-165	0	48	-188	0	35	-217	0	44
	Trochanterion (photo)	- 3	±187	- 19	- 33	±188	28	- 34	±217	33
	Iliocristale	- 83	±138	86	- 80	±161	93	-114	±197	105
	Anterior-Superior Iliac Spine	- 15	±103	75	-25	±116	83	- 27	±121	86
Pelvis (Surface)	Pubic Symphysis	44	0	32	51	0	41	50	0	50
	Thigh-Abdominal Junction	22	±117	60	21	±122	81	19	±155	94
	Trochanterion (skel. recon.)**	18	±190	- 18	20	±203	- 20	22	±215	- 22
	Pubotuberosity**	44	± 35	32	34	± 67	- 55	50	±35	50
	Pubic Symphysis	42	0	22	38	0	32	40	0	33
	H-Point	0	± 80	0	0	± 82	0	0	± 86	0
Pelvis (Skeletal)**	Inferior Symphyseal Pole	40	± 4	10	42	± 5	7	43	± 4	6
	Left Superior Pole, Pubic Symphysis	46	± 5	26	33	± 4	25	38	± 5	37
	Ilio-Spinale Summum	- 15	±109	72	- 25	±115	78	- 27	±115	79
	Iliocristale Summum	- 81	±114	77	-102	±119	74	-107	±125	74
	Inferior Tuberosity Point	24	± 48	- 56	37	± 39	- 61	42	± 41	- 62
	S1 Posterior Point	- 92	0	41	- 98	0	33	-105	0	34
	Promontorion	- 66	0	42	- 69	0	37	- 73	0	41
	S1 Lateral Point	- 80	± 19	46	- 89	± 26	39	- 93	± 28	42

TABLE 5.4
SURFACE LANDMARKS RELATIVE TO H-POINT (Continued)

Body Segment	Surface Landmark	SMALL FEMALE			MID-SIZED MALE			LARGE MALE			
		X _H	Y _H	Z _H	X _H	Y _H	Z _H	X _H	Y _H	Z _H	
Shoulder	Clavicale	-146	± 17	397	-145	± 23	443	-171	± 25	473	
	Acromio-Clavicular Artic.	-198	± 152	398	-215	± 182	443	-247	± 192	480	
	Greater Tubercle Humerus	-152	± 178	380	-173	± 218	421	-185	± 223	469	
	Acromion	-206	± 171	376	-224	± 203	419	-256	± 217	454	
	Anterior Scye	-106	± 130	337	- 97	± 154	380	-115	± 167	421	
	Posterior Scye	-191	± 164	286	-214	± 197	306	-245	± 221	328	
	Superior Margin Scapula	-262	± 66	379	-296	± 79	403	-331	± 83	446	
	Inferior Margin Scapula	-250	± 109	292	-276	± 126	267	-304	± 147	271	
	Arm	Lateral Humeral Epicondyle	12	± 211	206	32	± 242	224	34	± 266	270
		Radiale	28	± 207	193	46	± 243	209	52	± 261	252
Medial Humeral Epicondyle		15	± 150	190	32	± 173	199	27	± 189	236	
Olecranon		34	± 183	177	53	± 210	186	48	± 234	225	
Ulnar Styloid		130	± 182	383	226	± 191	387	262	± 197	398	
Stylian		121	± 136	387	211	± 135	399	245	± 138	414	
Leg and Foot	Lateral Femoral Epicondyle	360	± 119	72	404	± 189	129	411	± 207	157	
	Medial Femoral Epicondyle	365	± 32	69	407	± 87	142	414	± 98	175	
	Tibiale	378	± 35	58	424	± 88	128	433	± 97	163	
	Patella	404	± 81	91	449	± 150	172	460	± 168	202	
	Sphyrion	599	± 57	-172	684	± 61	-149	721	± 63	-131	
	Metatarsal-Phalangeal I	698	± 76'	-120	796	± 84	- 86	845	± 85	- 70	
	Digit II	729	± 126	- 74	839	± 147	- 37	889	± 150	- 14	
	Metatarsal-Phalangeal V	683	± 157	-147	785	± 174	-124	832	± 187	-105	
	Lateral Malleolus	584	± 115	-194	680	± 126	-185	711	± 135	-169	
	Posterior Calcaneus**	618	± 90	-254	705	± 94	-250	741	± 97	-238	

*Left side of body (+).

**Landmark location determined by construction.

TABLE 5.5

FORMULATION OF SEGMENTATION PLANES

Plane	Form	Formula*
Head	Small Female	$.38133X + .92444Z - 383.75 = 0$
	Mid-Sized Male	$.31354X + .94958Z - 462.33 = 0$
	Large Male	$.34482X + .93867Z - 473.43 = 0$
Neck	Small Female	$.70711X + .70711Z - 177.48 = 0$ (for all $X \geq -194$)
	Mid-Sized Male	$.70711X + .70711Z - 210.72 = 0$ (for all $X \geq -191$)
	Large Male	$.70711X + .70711Z - 213.55 = 0$ (for all $X \geq -229$)
Thorax	Small Female	$.41773X - .90857Z + 153.67 = 0$
	Mid-Sized Male	$.47138X - .88194Z + 161.14 = 0$
	Large Male	$.51108X - .85954Z + 187.31 = 0$
Abdomen	Small Female	$.42046X - .90731Z + 112.93 = 0$
	Mid-Sized Male	$.47312X - .88098Z + 119.78 = 0$
	Large Male	$.50957X - .86043Z + 148.44 = 0$
Hip	Small Female	$-.79326X \pm .60868Y + .01568Z + 55.706 = 0$
	Mid-Sized Male	$-.76487X \pm .64407Y + .01143Z + 61.082 = 0$
	Large Male	$-.78392X \pm .62046Y - .02216Z + 62.020 = 0$ (+ sign on Y for right side of body)
Knee	Small Female	$-.95067X + .31022Z + 319.90 = 0$
	Mid-Sized Male	$-.96788X + .25139Z + 358.59 = 0$
	Large Male	$-.97780X + .20953Z + 368.98 = 0$
Ankle	Small Female	$.74130X - .67118Z - 519.21 = 0$
	Mid-Sized Male	$.73904X - .67366Z - 605.88 = 0$
	Large Male	$.69191X - .72199Z - 593.44 = 0$
Shoulder	Small Female	$.37621X \pm .92649Y - .00936Z - 77.411 = 0$
	Mid-Sized Male	$.35502X \pm .93466Y - .01821Z - 102.580 = 0$
	Large Male	$.34605X \pm .93630Y + .05993Z - 141.80 = 0$ (+ sign on Y for left side of body)
Elbow	Small Female	$-.71664X \pm .14376Y - .68246Z + 118.85 = 0$
	Mid-Sized Male	$-.76349X \pm .22000Y - .60719Z + 107.20 = 0$
	Large Male	$-.84192X \pm .28017Y - .46117Z + 78.614 = 0$ (+ sign on Y for left side of body)

*X, Y, and Z are whole-body coordinate axes X_H , Y_H , Z_H . The subscripts have been omitted from the equations for clarity.

TABLE 5.6

LOCATIONS OF ORIGINS OF SEGMENT ANATOMICAL
COORDINATE SYSTEMS

Segment	Form	X _H (mm)	Y _H (mm)	Z _H (mm)
Head	Small Female	-180	0	545
	Mid-Sized Male	-185	0	614
	Large Male	-212	0	646
Neck	Small Female	-238	0	445
	Mid-Sized Male	-266	0	489
	Large Male	-300	0	531
Thorax	Small Female	-183	0	85
	Mid-Sized Male	-209	0	71
	Large Male	-237	0	77
Abdomen	Small Female	- 96	0	125
	Mid-Sized Male	- 93	0	133
	Large Male	-126	0	143
Pelvis	Small Female	- 15	0	75
	Mid-Sized Male	- 25	0	83
	Large Male	- 27	0	86
Upper Arms	Small Female	-206	±171*	376
	Mid-Sized Male	-224	±203	419
	Large Male	-256	±217	454
Lower Arms & Hands	Small Female	28	±207	193
	Mid-Sized Male	46	±243	209
	Large Male	52	±261	252
Upper Legs	Small Female	18	±190	- 18
	Mid-Sized Male	20	±203	- 20
	Large Male	22	±215	- 22
Lower Legs	Small Female	378	± 35	58
	Mid-Sized Male	424	± 88	128
	Large Male	433	± 97	163
Feet	Small Female	695	±115	-126
	Mid-Sized Male	796	±126	- 96
	Large Male	843	±134	- 80

*Left side of body (+).

TABLE 5.7
ANATOMICAL AXES WITH RESPECT TO HIP POINT AXIS SYSTEM
(Cosine Matrix Expressed in Degrees)

Segment	DIRECTION COSINE IN DEGREES											
	Small Female			Mid-Sized Male			Large Male					
	X _H	Y _H	Z _H	X _H	Y _H	Z _H	X _H	Y _H	Z _H			
Head	X _A	90.0	86.3	3.9	90.0	86.1	2.7	90.0	87.3			
	Y _A	0.0	90.0	90.0	0.0	90.0	90.0	0.0	90.0			
	Z _A	93.7	90.0	3.7	93.9	90.0	92.7	90.0	2.7			
Neck	X _A	27.5	90.0	117.6	20.8	90.0	24.2	90.0	114.2			
	Y _A	90.0	0.0	90.0	90.0	0.0	90.0	0.0	90.0			
	Z _A	62.4	90.0	27.5	69.2	90.0	65.8	90.2	24.2			
Thorax	X _A	8.7	90.0	81.3	7.8	90.0	7.9	90.0	82.1			
	Y _A	90.0	0.0	90.0	90.0	0.0	90.0	0.0	90.0			
	Z _A	98.7	90.0	8.7	97.8	90.0	97.9	90.0	7.9			
Abdomen	X _A	24.7	90.0	65.3	28.1	90.0	30.7	90.0	59.3			
	Y _A	90.0	0.0	90.0	90.0	0.0	90.0	0.0	90.0			
	Z _A	114.7	90.0	24.7	118.1	90.0	120.7	90.0	30.7			
Pelvis	X _A	53.9	90.0	36.1	61.1	90.0	64.9	90.0	25.1			
	Y _A	90.0	0.0	90.0	90.0	0.0	90.0	0.0	90.0			
	Z _A	143.9	90.0	53.9	151.0	90.0	154.9	90.0	64.9			

TABLE 5.7
 ANATOMICAL AXES WITH RESPECT TO HIP POINT AXIS SYSTEM
 (Cosine Matrix Expressed in Degrees, Continued)

Segment	DIRECTION COSINE IN DEGREES											
	Small Female			Mid-Sized Male			Large Male					
	X _H	Y _H	Z _H	X _H	Y _H	Z _H	X _H	Y _H	Z _H	X _H	Y _H	Z _H
Upper Arm (L)	X _A	99.7	40.4	52.5	105.7	41.8	57.3	112.4	41.4			
	Y _A	12.8	77.2	85.8	17.2	73.3	84.5	23.9	66.8			
	Z _A	141.3	98.2	52.5	142.2	53.0	146.7	98.1	58.0			
Upper Arm (R)	X _A	80.3	40.4	52.5	74.3	41.8	57.3	67.6	41.4			
	Y _A	12.8	102.8	94.2	17.2	106.7	95.5	23.9	113.2			
	Z _A	141.3	81.8	52.5	142.2	53.0	146.7	81.9	58.0			
Lower Arm with Hand (L)	X _A	78.0	61.1	128.2	71.4	44.1	117.3	69.3	35.4			
	Y _A	13.8	90.0	68.6	22.2	95.6	66.8	25.4	99.8			
	Z _A	118.0	83.4	151.1	134.1	133.5	142.8	76.0	123.6			
Lower Arm with Hand (R)	X _A	102.0	61.1	128.2	108.6	44.1	117.3	110.7	35.4			
	Y _A	13.8	90.0	111.4	22.2	84.4	113.2	25.4	80.2			
	Z _A	118.0	96.6	151.1	134.1	133.5	142.8	104.0	123.6			
Upper Leg (L)	X _A	92.8	15.5	110.9	83.8	21.9	114.3	82.1	25.7			
	Y _A	11.7	84.4	86.0	6.3	95.1	85.7	8.0	96.7			
	Z _A	161.5	78.6	104.4	158.8	111.2	155.3	88.9	114.7			
Upper Leg (R)	X _A	87.2	15.5	110.9	96.2	21.9	114.3	97.9	25.7			
	Y _A	11.7	95.6	94.0	6.3	84.9	94.3	8.0	83.3			
	Z _A	161.5	101.4	104.4	158.8	111.2	155.3	91.1	114.7			

TABLE 5.7
ANATOMICAL AXES WITH RESPECT TO HIP POINT AXIS SYSTEM
(Cosine Matrix Expressed in Degrees, Continued)

Segment	DIRECTION COSINE IN DEGREES														
	Small Female						Mid-Sized Male						Large Male		
	X _H	Y _H	Z _H	X _H	Y _H	Z _H	X _H	Y _H	Z _H	X _H	Y _H	Z _H			
Lower Leg (L)	X _A	50.4	65.7	49.3	46.2	67.6	52.2	47.7	65.4	52.3					
	Y _A	109.9	24.7	103.9	103.5	22.9	108.0	104.2	25.1	110.2					
	Z _A	133.7	93.9	44.0	133.1	85.9	43.3	134.2	85.3	44.6					
Lower Leg (R)	X _A	50.4	114.3	49.3	46.2	112.4	52.2	47.7	114.6	52.3					
	Y _A	70.1	24.7	76.1	76.5	22.9	72.0	75.8	25.1	69.8					
	Z _A	133.7	86.1	44.0	133.1	94.1	43.3	134.2	94.7	44.6					
Foot	X _A	59.5	80.3	32.3	59.9	78.4	32.7	57.8	79.0	34.4					
	Y _A	94.4	9.6	98.7	90.0	13.4	103.4	92.3	11.8	101.5					
	Z _A	149.1	89.3	59.1	149.9	83.3	60.8	147.7	85.8	58.1					
Foot (R)	X _A	59.5	99.7	32.3	59.9	101.6	32.7	57.8	101.0	34.4					
	Y _A	85.6	9.6	81.3	90.0	13.4	76.6	87.7	11.8	78.5					
	Z _A	149.1	90.7	59.1	149.9	96.7	60.8	147.7	94.2	58.1					

TABLE 5.8
ESTIMATED SEGMENT MASS AND VOLUME

Segment	SMALL FEMALE		MID-SIZED MALE		LARGE MALE	
	Predicted Vol (cm ³)	Predicted Mass (gm)	Predicted Vol (cm ³)	Predicted Mass (gm)	Predicted Vol (cm ³)	Predicted Mass (gm)
Head	3,697	3,697	4,337	4,137	4,753	4,511
Neck	601	601	1,012	965	1,231	1,168
Thorax	12,983	12,983	24,909	23,763	34,160	32,418
Abdomen	1,610	1,610	2,479	2,365	3,108	2,949
Pelvis	6,976	6,976	11,964	11,414	16,900	16,038
Upper Arm (each one)	1,124	1,124	1,854	1,769	2,431	2,307
Lower Arm and Hand (each one)	1,138	1,138	2,120	2,022	2,556	2,426
Upper Leg (each one)	5,914	5,914	9,029	8,614	11,950	11,341
Lower Leg (each one)	2,360	2,360	3,760	3,587	5,331	5,059
Foot (each one)	638	638	1,028	981	1,638	1,554
WHOLE BODY	48,215	48,215	80,254	76,562	107,964	102,458

TABLE 5.9

LOCATION OF ESTIMATED SEGMENT CENTERS OF GRAVITY
WITH RESPECT TO WHOLE-BODY COORDINATE SYSTEMS

Segment	Form	X _H (mm)	Y _H (mm)	Z _H (mm)
Head	Small Female	-184	0	578
	Mid-Sized Male	-179	0	646
	Large Male	-205	0	678
Neck	Small Female	-172	0	460
	Mid-Sized Male	-195	0	515
	Large Male	-217	0	557
Thorax	Small Female	-147	0	238
	Mid-Sized Male	-177	0	267
	Large Male	-198	0	292
Abdomen	Small Female	- 82	0	107
	Mid-Sized Male	- 85	0	110
	Large Male	-118	0	120
Pelvis	Small Female	- 76	0	25
	Mid-Sized Male	- 74	0	17
	Large Male	- 73	0	13
Upper Arms	Small Female	- 91	±163*	280
	Mid-Sized Male	- 80	±191	319
	Large Male	- 94	±205	356
Lower Arms and Hands	Small Female	97	±176	306
	Mid-Sized Male	149	±174	320
	Large Male	183	±182	347
Upper Legs	Small Female	147	±104	- 4
	Mid-Sized Male	200	±131	64
	Large Male	203	±140	80
Lower Legs	Small Female	444	± 82	- 56
	Mid-Sized Male	504	±125	- 5
	Large Male	514	±136	26
Feet	Small Female	653	±101	-178
	Mid-Sized Male	763	±110	-164
	Large Male	805	±119	-151

*Left side of body (+).

TABLE 5.10

LOCATION OF ESTIMATED SEGMENT CENTERS OF GRAVITY
WITH RESPECT TO SEGMENT COORDINATE SYSTEMS

Segment	Form	X_A (mm)	Y_A (mm)	Z_A (mm)
Head	Small Female	- 2	0	33
	Mid-Sized Male	8	0	31
	Large Male	9	0	31
Neck	Small Female	52	0	44
	Mid-Sized Male	57	0	50
	Large Male	65	0	57
Thorax	Small Female	59	0	146
	Mid-Sized Male	58	0	190
	Large Male	68	0	208
Abdomen	Small Female	5	0	- 22
	Mid-Sized Male	- 4	0	- 24
	Large Male	- 5	0	- 24
Pelvis	Small Female	- 76	0	20
	Mid-Sized Male	- 82	0	11
	Large Male	- 86	0	11
Upper Arms	Small Female	0	$\pm 30^*$	-147
	Mid-Sized Male	17	± 30	-172
	Large Male	19	± 34	-186
Lower Arms with Hands	Small Female	- 11	± 14	-135
	Mid-Sized Male	- 10	± 35	-166
	Large Male	- 11	± 36	-177
Upper Legs	Small Female	- 16	± 60	-143
	Mid-Sized Male	6	± 66	-200
	Large Male	7	± 73	-209
Lower Legs	Small Female	- 13	∓ 48	-131
	Mid-Sized Male	- 12	∓ 57	-149
	Large Male	- 13	∓ 63	-151
Feet	Small Female	- 68	± 3	9
	Mid-Sized Male	- 77	∓ 1	- 6
	Large Male	- 82	∓ 1	- 6

*For Y_A , the top sign refers to the right side of the body.

TABLE 5.11
ESTIMATED SEGMENT INERTIAL PROPERTIES

Segment	Form	I_x (gm cm ²)	I_y (gm cm ²)	I_z (gm cm ²)
Head	Small Female	146,150	172,919	131,715
	Mid-Sized Male	200,271	221,546	144,552
	Large Male	225,900	263,100	168,700
Neck	Small Female	6,084	9,510	10,295
	Mid-Sized Male	14,798	18,463	22,910
	Large male	21,800	24,400	31,900
Thorax	Small Female	1,542,806	1,161,238	1,208,626
	Mid-Sized Male	4,566,400	3,222,558	3,015,877
	Large Male	7,351,000	5,474,000	4,904,000
Abdomen	Small Female	143,484	101,463	205,715
	Mid-Sized Male	167,611	106,560	254,838
	Large Male	262,000	165,000	481,000
Pelvis	Small Female	326,244	282,872	574,158
	Mid-Sized Male	1,015,738	942,376	1,184,697
	Large Male	1,720,000	1,553,000	1,956,000
Upper Arms	Small Female	49,980	51,135	8,168
	Mid-Sized Male	112,467	122,526	23,115
	Large Male	179,000	187,000	51,500
Lower Arms with Hands	Small Female	141,515	129,402	8,342
	Mid-Sized Male	310,769	309,252	20,148
	Large Male	414,000	400,000	28,000
Upper Legs	Small Female	731,416	700,953	153,857
	Mid-Sized Male	1,230,899	1,301,540	367,118
	Large Male	1,926,000	2,000,000	593,000
Lower Legs	Small Female	261,414	261,922	23,135
	Mid-Sized Male	520,397	528,342	60,688
	Large Male	831,000	834,000	93,800
Feet	Small Female	3,441	18,428	16,614
	Mid-Sized Male	8,728	42,966	44,132
	Large Male	10,400	75,100	77,600

TABLE 5.12

PRINCIPAL AXES OF INERTIA WITH RESPECT TO ANATOMICAL AXES
(Cosine Matrix Expressed in Degrees)

Segment	DIRECTION COSINE IN DEGREES												
	Small Female				Mid-Sized Male				Large Male				
	X _A	Y _A	Z _A		X _A	Y _A	Z _A		X _A	Y _A	Z _A		
Head	X _P	90.0	48	36	90.0	54	36	90.0	54	90.0	54	36	90.0
	Y _P	0.0	90.0	90.0	0.0	90.0	90.0	0.0	90.0	0.0	90.0	90.0	0.0
	Z _P	132	90.0	42	126	90.0	36	126	90.0	36	90.0	36	90.0
Neck	X _P	8.6	90.0	81.4	11	90.0	79	11	90.0	79	11	90.0	79
	Y _P	90.0	0.0	90.0	90.0	0.0	90.0	90.0	0.0	90.0	90.0	0.0	90.0
	Z _P	98.6	90.0	8.6	101	90.0	11	101	90.0	11	90.0	11	90.0
Thorax	X _P	19.1	90.0	70.9	14.5	90.0	75.5	14.5	90.0	75.5	14.5	90.0	75.5
	Y _P	90.0	0.0	90.0	90.0	0.0	90.0	90.0	0.0	90.0	90.0	0.0	90.0
	Z _P	109.1	90.0	19.1	104.5	90.0	14.5	104.5	90.0	14.5	90.0	14.5	90.0
Abdomen	X _P	0.0	90.0	90.0	2.6	90.0	92.2	2.6	90.0	92.2	2.6	90.0	92.2
	Y _P	90.0	0.0	90.0	90.0	0.0	90.0	90.0	0.0	90.0	90.0	0.0	90.0
	Z _P	90.0	90.0	0.0	87.8	90.0	2.6	87.8	90.0	2.6	87.8	90.0	2.6
Pelvis	X _P	2.7	90.0	92.7	8.4	90.0	81.6	8.4	90.0	81.6	8.4	90.0	81.6
	Y _P	90.0	0.0	90.0	90.0	0.0	90.0	90.0	0.0	90.0	90.0	0.0	90.0
	Z _P	87.3	90.0	2.7	98.4	90.0	8.4	98.4	90.0	8.4	98.4	90.0	8.4

TABLE 5.12
PRINCIPAL AXES OF INERTIA WITH RESPECT TO ANATOMICAL AXES
 (Cosine Matrix Expressed in Degrees, Continued)

Segment	DIRECTION COSINE IN DEGREES											
	Small Female			Mid-Sized Male			Large Male					
	X _A	Y _A	Z _A	X _A	Y _A	Z _A	X _A	Y _A	Z _A	X _A	Y _A	Z _A
Upper Arm (L)	X _P	116.6	84.1	33.6	56.6	91.1	33.9	56.1	90.0	33.9	56.1	90.0
	Y _P	63.4	27.7	123.4	34.3	83	123.9	33.9	90.0	123.9	33.9	90.0
	Z _P	92.5	82.9	8.6	90	7	90.0	90.0	0.0	90.0	90.0	0.0
Upper Arm (R)	X _P	27	63.4	84.1	33.6	123.4	33.9	123.9	90.0	33.9	123.9	90.0
	Y _P	116.6	27.7	82.9	56.6	34.3	56.1	33.9	90.0	56.1	33.9	90.0
	Z _P	92.5	97.3	8.6	90	83	90.0	90.0	0.0	90.0	90.0	0.0
Lower Arm with Hand (L)	X _P	17	74.4	95.4	19.5	70.5	19.5	70.5	90.0	19.5	70.5	90.0
	Y _P	105.6	17.3	82.8	109.5	19.5	109.5	19.5	90.0	109.5	19.5	90.0
	Z _P	82.6	97.2	9.7	90.0	90.0	90.0	90.0	1.0	90.0	90.0	1.0
Lower Arm with Hand (R)	X _P	17	105.6	95.4	19.5	109.5	19.5	109.5	90.0	19.5	109.5	90.0
	Y _P	74.4	17.3	97.2	70.5	19.5	70.5	19.5	90.0	70.5	19.5	90.0
	Z _P	82.6	82.8	9.7	90.0	90.0	90.0	90.0	1.0	90.0	90.0	1.0
Upper Leg (L)	X _P	15.2	77.3	81.7	9.8	80.2	9.8	80.2	89.8	9.8	80.2	90.0
	Y _P	102.7	12.8	88.8	99.8	9.8	99.8	9.8	90.9	99.8	9.8	90.0
	Z _P	98.3	91.2	8.4	90.1	89.1	90.0	89.1	1.1	90.0	90.0	0.0
Upper Leg (R)	X _P	15.2	102.7	81.7	9.8	99.8	9.8	99.8	89.8	9.8	99.8	90.0
	Y _P	77.3	12.8	91.2	80.2	9.8	80.2	9.8	90.9	80.2	9.8	90.0
	Z _P	98.3	88.8	8.4	90.1	89.1	90.0	89.1	1.1	90.0	90.0	0.0

TABLE 5.12
PRINCIPAL AXES OF INERTIA WITH RESPECT TO ANATOMICAL AXES
(Cosine Matrix Expressed in Degrees, Continued)

Segment	DIRECTION COSINE IN DEGREES											
	Small Female			Mid-Sized Male			Large Male					
	X _A	Y _A	Z _A	X _A	Y _A	Z _A	X _A	Y _A	Z _A	X _A	Y _A	Z _A
Lower Leg (L)	X _P	90.0	90.0	24	114	90	24	114	90	24	114	90
	Y _P	90.0	0.0	66	24	92	66	24	92	66	24	92
	Z _P	90.0	90.0	0.0	90	88	90	88	1	90	88	1
Lower Leg (R)	X _P	0.0	90.0	90.0	24	66	24	66	90	24	66	90
	Y _P	90.0	0.0	90.0	114	24	114	24	88	114	24	88
	Z _P	90.0	90.0	0.0	90	92	90	92	1	90	92	1
Foot (L)	X _P	6.3	90.3	96.3	10	94	10	94	81	10	94	81
	Y _P	91.5	16.5	106.4	86	7	86	7	95	86	7	95
	Z _P	83.7	73.5	17.6	99	85	99	85	10	99	85	10
Foot (R)	X _P	6.3	89.7	96.3	10	86	10	86	81	10	86	81
	Y _P	88.4	16.5	73.6	94	7	94	7	85	94	7	85
	Z _P	83.7	106.5	17.6	99	95	99	95	10	99	95	10

TABLE 5.13

PRINCIPAL AXES OF INERTIA WITH RESPECT TO HIP POINT AXIS SYSTEM
(Cosine Axis Expressed in Degrees)

Segment	DIRECTION COSINE IN DEGREES											
	Small Female			Mid-Sized Male			Large Male					
	X _H	Y _H	Z _H	X _H	Y _H	Z _H	X _H	Y _H	Z _H	X _H	Y _H	Z _H
Head	X _P	45.7	90.0	44.3	39.8	90.0	50.1	38.7	90.0	51.3		
	Y _P	90.0	0.0	90.0	90.0	0.0	90.0	90.0	0.0	90.0		
	Z _P	135.7	90.0	45.7	129.9	90.0	39.8	128.7	90.0	38.7		
Neck	X _P	18.7	90.0	109	9.9	90.0	99.7	13.2	90.0	103.1		
	Y _P	90.0	0.0	90.0	90.0	0.0	90.0	90.0	0.0	90.0		
	Z _P	71	90.0	18.7	80.3	90.0	9.9	76.9	90.0	13.2		
Thorax	X _P	28	90.0	62	22.3	0.0	67.7	22.3	90.0	67.6		
	Y _P	90.0	0.0	90.0	90.0	1.0	90.0	90.0	0.0	90.0		
	Z _P	118	90.0	28	112.3	0.0	22.3	112.4	90.0	22.3		
Abdomen	X _P	24.7	90.0	65.3	26.0	90.0	64.1	28.5	90.0	61.5		
	Y _P	90.0	0.0	90.0	90.0	0.0	90.0	90.0	0.0	90.0		
	Z _P	114.7	90.0	24.7	115.9	90.0	26.0	118.5	90.0	28.5		
Pelvis	X _P	51.2	90.0	38.7	69.4	90.0	20.6	73.3	90.0	16.7		
	Y _P	90.0	0.0	90.0	90.0	0.0	90.0	90.0	0.0	90.0		
	Z _P	141.3	90.0	51.2	159.4	90.0	69.4	163.3	90.0	73.3		

TABLE 5.13
 PRINCIPAL AXES OF INERTIA WITH RESPECT TO HIP POINT AXIS SYSTEM
 (Cosine Matrix Expressed in Degrees, Continued)

Segment	DIRECTION COSINE IN DEGREES											
	Small Female			Mid-Sized Male			Large Male					
	X _H	Y _H	Z _H	X _H	Y _H	Z _H	X _H	Y _H	Z _H	X _H	Y _H	Z _H
Upper Arm (L)	X _P	127	50	56	72	40	59.9	78.8	32.6	59.9	78.8	32.6
	Y _P	36	63	106	20	100	102.8	13.9	95.2	102.8	13.9	95.2
	Z _P	91	53	142	97	53	146.7	98.1	58.0	146.7	98.1	58.0
Upper Arm (R)	X _P	53	50	56	108	40	59.9	101.2	32.6	59.9	101.2	32.6
	Y _P	36	117	74	20	80	77.2	13.9	84.8	77.2	13.9	84.8
	Z _P	89	53	142	83	53	146.7	81.9	58.0	146.7	81.9	58.0
Lower Arm with Hand (L)	X _P	63.3	57.0	117	52	50	107.5	50.6	44.6	107.5	50.6	44.6
	Y _P	27.6	103.9	57	40	109	58.3	42.8	115.6	58.3	42.8	115.6
	Z _P	88.9	143.1	134	78	134	142.8	75.9	123.6	142.8	75.9	123.6
Lower Arm with Hand (R)	X _P	116.7	57.0	117	128	50	107.5	129.4	44.6	107.5	129.4	44.6
	Y _P	27.6	76.1	123	40	71	121.7	42.8	64.4	121.7	42.8	64.4
	Z _P	91.1	143.1	134	102	134	142.8	104.1	123.6	142.8	104.1	123.6
Upper Leg (L)	X _P	78.6	23.8	110	74	26	113.2	72.3	29.8	113.2	72.3	29.8
	Y _P	14.3	97.0	83	16	104	81.8	17.9	105.6	81.8	17.9	105.6
	Z _P	79.6	112.8	159	89	111	155.2	88.9	114.7	155.2	88.9	114.7
Upper Leg (R)	X _P	101.4	23.8	110	106	26	113.2	107.7	29.8	113.2	107.7	29.8
	Y _P	14.3	83.0	97	16	76	98.2	17.9	74.4	98.2	17.9	74.4
	Z _P	100.4	112.8	159	91	111	155.2	91.1	114.7	155.2	91.1	114.7

TABLE 5.13
 PRINCIPAL AXES OF INERTIA WITH RESPECT TO HIP POINT AXIS SYSTEM
 (Cosine Matrix Expressed in Degrees, Continued)

Segment	DIRECTION COSINE IN DEGREES											
	Small Female			Mid-Sized Male			Large Male					
	X _H	Y _H	Z _H	X _H	Y _H	Z _H	X _H	Y _H	Z _H	X _H	Y _H	Z _H
Lower Leg (L)	X _P	50.4	65.7	49.3	43	92	47	44.4	89.4	45.7		
	Y _P	109.9	24.7	103.9	85	6	93	85.8	6.5	95.3		
	Z _P	133.7	93.9	44	134	84	44	134.9	83.5	45.6		
Lower Leg (R)	X _P	50.4	114.3	49.3	43	88	47	44.4	90.6	45.7		
	Y _P	70.1	24.7	76.1	95	6	87	94.2	6.5	84.7		
	Z _P	133.7	86.1	44	134	96	44	134.9	96.5	45.6		
Foot (L)	X _P	53.6	66.4	45.4	69	82	23	66.7	82.5	24.6		
	Y _P	96.8	25.4	114.5	84	14	102	85.9	12.0	100.8		
	Z _P	142.8	80.6	54.5	158	80	71	156.9	82.7	68.0		
Foot (R)	X _P	53.6	113.6	45.4	69	98	23	66.7	97.5	24.6		
	Y _P	83.2	25.4	65.5	96	14	78	94.1	12.0	79.2		
	Z _P	142.8	99.4	54.5	158	100	71	156.9	97.3	68.0		

TABLE 5.14
LOCATION OF JOINT CENTERS

Segment	Form	X _H (mm)	Y _H (mm)	Z _H (mm)
Head/Neck	Small Female	-189	0	519
	Mid-Sized Male	-196	0	588
	Large Male	-222	0	619
C7/T1	Small Female	-183	0	429
	Mid-Sized Male	-193	0	469
	Large Male	-216	0	506
T4/T5	Small Female	-205	0	381
	Mid-Sized Male	-220	0	397
	Large Male	-248	0	439
T8/T9	Small Female	-196	0	273
	Mid-Sized Male	-215	0	287
	Large Male	-246	0	320
T12/L1	Small Female	-149	0	140
	Mid-Sized Male	-177	0	165
	Large Male	-203	0	175
L2/L3	Small Female	-121	0	102
	Mid-Sized Male	-142	0	115
	Large Male	-159	0	122
L5/S1	Small Female	- 80	0	46
	Mid-Sized Male	- 89	0	39
	Large Male	- 93	0	42
Sternoclavicular	Small Female	-146	± 17*	389
	Mid-Sized Male	-145	± 20	433
	Large Male	-171	± 25	462
Claviscapular	Small Female	-211	±140	390
	Mid-Sized Male	-230	±168	427
	Large Male	-261	±177	470
Glenohumeral	Small Female	-174	±146	354
	Mid-Sized Male	-186	±173	393
	Large Male	-217	±186	427
Elbow	Small Female	20	±179	188
	Mid-Sized Male	36	±208	201
	Large Male	36	±225	242

TABLE 5.14
LOCATION OF JOINT CENTERS (Continued)

Segment	Form	X _H (mm)	Y _H (mm)	Z _H (mm)
Wrist	Small Female	134	±155	385
	Mid-Sized Male	228	±158	393
	Large Male	264	±162	406
Hip	Small Female	0	± 80	0
	Mid-Sized Male	0	± 82	0
	Large Male	0	± 86	0
Knee	Small Female	363	± 75	71
	Mid-Sized Male	406	±138	136
	Large Male	413	±153	166
Ankle	Small Female	593	± 86	-182
	Mid-Sized Male	684	± 94	-169
	Large Male	718	± 99	-152

*Left side of body (+).

TABLE 5.15
RANGE-OF-MOTION DATA

Quantity	Value (deg)	Reference
<u>Head</u>		
Ventral flexion	55 (60)	Snyder et al. (1975) (Glanville & Kreezer 1937)
Dorsal flexion (hyperextension)	49 (61)	
Lateral Flexion	35 (41)	
Rotation	67 (74)	
<u>Vertebral Column</u>		
Rotation of T1 with respect to T12 (flexion)	15	Mital et al. (1979)
Rotation of T12 with respect to pelvis (flexion)	16	Mital et al. (1979)
Rotation of T1 with respect to T12 (extension)	20	Mital et al. (1979)
Rotation of T12 with respect to pelvis (extension)	7	Mital et al. (1979)
Lateral flexion	42 (?)	Robbins et al. (1971)
Rotation about long axis	±45 (?)	(Con. No. DOT-HS-5-01232)
<u>Shoulder (Three Links)</u>		
Flexion (sagittal plane)	188	Dempster (1955)
Extension (sagittal plane)	61	Dempster (1955)
Abduction (coronal plane)	129	Glanville & Kreezer (1937)
Abduction (transverse plane)	134	Dempster (1955)
Adduction (transverse plane)	48	Dempster (1955)
<u>Shoulder (Clavicle Link)</u>		
Protraction (transverse plane)	15	(Derived from
Retraction (transverse plane)	20	Dempster 1955)
Depressed (coronal plane)	8	
Shrugged (coronal plane)	36	
<u>Elbow</u>		
Extension	0	Dempster (1955)
Flexion	142	Dempster (1955)
<u>Hip</u>		
Flexion	113 (168)	Dempster (1955) (Glanville & Kreezer 1937)
Abduction (transverse plane)	53	Dempster (1955)
Adduction (transverse plane)	31	Dempster (1955)
Abduction (coronal plane)	70	Glanville & Kreezer (1937)
Medial rotation (prone)	39	Dempster (1955)
Lateral rotation (prone)	34	Dempster (1955)
Medial rotation (sitting)	31	Dempster (1955)
Lateral rotation (sitting)	30	Dempster (1955)

TABLE 5.15
RANGE-OF-MOTION DATA (Continued)

Quantity	Value (deg)	Reference
<u>Knee</u>		
Voluntary flexion (prone)	125	Dempster (1955)
Forced flexion	144	Dempster (1955)
Forced flexion (kneeling)	159	Dempster (1955)
Medial rotation	35	Dempster (1955)
Lateral rotation	43	Dempster (1955)
<u>Ankle</u>		
Dorsiflexion	35	Dempster (1955)
Plantar flexion	38	Dempster (1955)
Inversion	24	Dempster (1955)
Eversion	23	Dempster (1955)

6.0 REFERENCES

- Abraham, S.; Johnson, C.L.; and Najjar, F. (1979a) Weight and height of adults 18-74 years of age. Vital and Health Statistics, Series 11, Number 211.
- Abraham, S.; Johnson, C.L.; and Najjar, M.F. (1979b) Weight and height and age for adults 18-74 years. Vital and Health Statistics, Series 11, Number 208.
- Annis, J.F. (1978) Variability in human body size. Anthropometric Source Book, Volume 1: Anthropometry for Designers. NASA Reference Publication 1024.
- Backaitis, S.; and Haffner, M. (1979) Development of the NHTSA advanced dummy for the occupant protection standard upgrade. 7th International Technical Conference on Experimental Safety Vehicles, pp. 395-407. National Highway Traffic Safety Administration, Washington, D.C.
- Backaitis, S.; and Najjar, D. (1980) Relative likelihood of injury in accidents as a function of occupant size and weight. SAE paper no. 800096.
- Backaitis, S.; and Stephens, M. (1976) The anthropometric profile of the injured car occupant and the incidence of injury severity. Proc. 20th American Association for Automotive Medicine Conference, pp. 350-366. AAAM, Morton Grove, Ill.
- Bakwin, H. (1964) The secular change in growth and development. Acta Paediatrica, 53:78-89.
- Bakwin, H.; and McLaughlin, S.M. (1964) Secular increase in height. Is the end in sight? The Lancet, 5:1195-1196.
- Barter, J.T.; Emanuel, I.; and Truett, B. (1957) A statistical evaluation of joint range data. Wright-Patterson AFB, Wright Air Development Center, WADC TN-57-311.
- Borkan, G.A.; Hults, D.E.; and Glynn, R.J. (1983) Role of longitudinal change and secular trend in age differences in male body dimensions. Human Biology, 55:3.
- Bowman, B.M.; Bennett, R.O.; and Robbins, D.H. (1979) MVMA Two-Dimensional Crash Victim Simulation, Version 4. The University of Michigan, Highway Safety Research Institute, Report No. UM-HSRI-79-5-1.
- Bowman, B.M.; and Robbins, D.H. (1972) Parameter study of biomechanical quantities in analytical neck models. Proc. 16th Stapp Car Crash Conference, pp. 455-485.

- Cheng, R.; Mital, N.K.; Levine, R.S.; and King, A.I. (1979) Biodynamics of the living spine during -Gx impact acceleration. Proc. 23rd Stapp Car Crash Conference, pp. 721-764.
- Churchill, E.; and Truett, B. (1957) Metrical relations among dimensions of the head and face. Wright-Patterson AFB, Wright Air Development Center, WADC-TD-56-621.
- Clauser, C.E.; McConville, J.T.; and Young, J.W. (1969) Weight, volume, and center of mass segment of the human body. Wright-Patterson AFB, Aerospace Medical Research Laboratory, AMRL-TR-69-70.
- Damon, A. (1968) Secular trend in height and weight within old American families at Harvard, 1870-1965. American Journal of Physical Anthropology, 29:45-50.
- Damon, A. (1977) Human Biology and Ecology. W.W. Morton, New York.
- Dempster, W.T. (1955) Space requirements of the seated operator. Wright-Patterson AFB, Wright Air Development Center, WADC-TR-55-159.
- Dempster, W.T. (1965) Mechanics of shoulder movement. Archives of Physical Medicine and Rehabilitation, 46:49-69.
- Dempster, W.T.; and Gaughran, G.R.L. (1967) Properties of body segments based on size and weight. American Journal of Anatomy, 120:33-54.
- Deutsches Institut fur Normung. (1979) Korpermasse des Menschen. DIN 33 402, DIN 33 408.
- Engin, A.E. (1979) Passive resistive torques about long bone axes of major human joints. Aviation, Space, and Environmental Medicine, 50:1052-57.
- Engin, A.E. (1980) On the biomechanics of the shoulder complex. Journal of Biomechanics, 13:575-590.
- Engin, A.E. (1981) Long bone and joint response to mechanical loading. Ohio State University for Air Force Office of Scientific Research.
- Engin, A.E.; and Kaleps, I. (1980) Active muscle torques about long-bone axes of major human joints. Aviation, Space, and Environmental Medicine, 51:551-555.
- Engin, A.E.; and Kazarian, L. (1981) Active muscle force and moment response of the human arm and shoulder. Aviation, Space, and Environmental Medicine, 52:523-530.
- Ewing, C.L.; and Thomas, D.J. (1972) Human head and neck response to impact acceleration. Naval Aerospace Medical Research Laboratory, Monograph 21.

- Ewing, C.L.; and Thomas, D.J. (1973) Response of human head to impact. Proc. 17th Stapp Car Crash Conference, pp. 309-342.
- Ferlic, D. (1962) The range of motion of the normal cervical spine. Hopkins Hospital Bulletin, 110.
- Foster, J.K.; Kortge, J.O.; and Wolanin, M.J. (1977) Hybrid III--A biomechanically-based crash test dummy. Proc. 21st Stapp Car Crash Conference, pp. 973-1014.
- Gimotty, P.A.; Campbell, K.L.; Chirachavala, T.; Carsten, O.; and O'Day, J. (1980) Statistical analysis of the national crash severity study. The University of Michigan, Highway Safety Research Institute, UM-HSRI-80-38.
- Glanville, A.D.; and Kreezer, G. (1937) The maximum amplitude and velocity of joint movements in normal male human adults. Human Biology, 9:197-211.
- Gsell, O.R. (1967) Longitudinal gerontology research over ten years. Gerontology Clinics, 9:67-80.
- Guttman, I.; and Wilks, S. (1965) Introductory engineering statistics. John Wiley & Sons, Inc., New York.
- Hamill, P.V.; Terrence, A.D.; Johnson, C.L.; Reed, R.B.; and Roche, A.F. (1977) NCHS growth curves for children birth to 18 years. Vital and Health Statistics, Series 11, Number 165.
- Haslegrave, C.M. (1980) Anthropometric profile of the British car driver. Ergonomics, 23:437-467.
- Hertzberg, H.T.E. (1970) Misconceptions regarding the design and use of anthropomorphic dummies. MIRA Bulletin, 4:17-21.
- Hertzog, K.P.; Garner, S.M.; and Hemby, H.O. (1969) Partitioning the effects of secular trend and aging on adult stature. American Journal of Physical Anthropology N.S., 31:111-115.
- Johnson, C.L.; Robinson, F.; Abraham, S; and Bryner, J.D. (1981) Basic data on anthropometric measurements and angular measurements of the hip and knee joints for selected age groups 1-74 years of age. Vital and Health Statistics, Series 11, Number 219.
- King, A.I.; and Cheng, R. (1983) Kinesiology of the shoulder and spine. Wayne State University, Bioengineering Center, Contract DOT-HS-5-01232 (in press).
- Krieger, K. (1976) Full scale experimental simulation of pedestrian-vehicle impacts. PhD dissertation, Wayne State University, Detroit.

- Maresh, M.M. (1972) A forty-five year investigation for secular changes in physical maturation. American Journal of Physical Anthropology, 36:103-110.
- McConville, J.T.; Churchill, T.D.; Kaleps, I.; Clauser, C.E.; and Cuzzi, J. (1980) Anthropometric relationships of body and body segment moments of inertia. Wright-Patterson AFB, Aerospace Medical Research Laboratory, AMRL-TR-80-119.
- Mertz, H.J.; and Patrick, L.M. (1971) Strength and response of the human neck. Proc. 15th Stapp Car Crash Conference, pp. 207-255.
- Mital, N.K.; Cheng, R.; King, A.I.; and Eppinger, R.H. (1979) A new design for a surrogate spine. Proc. 7th International Technical Conference on Experimental Safety Vehicles, pp. 427-428. U.S. Government Printing Office, Washington, D.C.
- Mital, N.K.; Cheng, R.; Levine, R.S.; and King, A.I. (1978) Dynamic characteristics of the human spine during -Gx acceleration. Proc. 22nd Stapp Car Crash Conference, pp. 139-165.
- Nyquist, G. (1977) Height, weight, and sex of injured automobile occupants. General Motors Corporation, Environmental Activities Staff Document, Warren, Mich.
- Nyquist, G.W.; and Murton, C.J. (1975) Static bending response of the lower human torso. Proc. 19th Stapp Car Crash Conference, pp. 513-541.
- Pheasant, S.T. (1982) Anthropometric estimates for British civilian adults. Ergonomics, 25:993-1001.
- Rabiffe, R.; Gullien, J.; and Pasquet, P. (1982) Enquete anthropometrique sur les conducteurs francais. Laboratoire de Physiologie et de biomecanique de l'association Peugeot-Renault.
- Reynolds, H.M.; Clauser, C.E.; McConville, J.; Chandler, R.; and Young, J.W. (1975) Mass distribution properties of the male cadaver. SAE paper no. 750424.
- Reynolds, H.M.; Snow, C.C.; and Young, J.W. (1981) Spatial geometry of the human pelvis. Federal Aviation Administration, Memorandum Report No. AAC-119-81-5.
- Ricci, L.L., ed. (1980) NCSS statistics: Passenger cars. The University of Michigan, Highway Safety Research Institute, UM-HSRI-80-36.
- Robbins, D.H.; Snyder, R.G.; Chaffin, D.B.; and Foust, D.R. (1974) A mathematical study of the effect of neck physical parameters on injury susceptibility. SAE paper no. 740274.
- Robbins, D.H.; Snyder, R.G.; and Roberts, V.L. (1971) Mathematical simulation of daisy track human volunteer tests. The University of Michigan, Highway Safety Research Institute, HSRI-BIOM-71-6.

- Schneider, L.W.; Foust, D.R.; Bowman, B.M.; Snyder, R.G.; Chaffin, D.B.; Abdelnour, T.R.; and Baum, J.K. (1975) Biomechanical properties of the human neck in lateral flexion. Proc. 19th Stapp Car Crash Conference, pp. 455-485.
- Searle, J.A.; and Haslegrave, C.M. (1970) Anthropometric dummies for crash research. MIRA Bulletin, 5.
- Snyder, R.G.; Chaffin, D.B.; and Schutz, R.K. (1972) Link system of the human torso. Wright-Patterson AFB, Aerospace Medical Research Laboratory, AMRL-TR-71-88.
- Snyder, R.G.; Chaffin, D.B.; and Foust, D.R. (1975a) Bioengineering study of basic physical measurements related to susceptibility to cervical hyperextension-hyperflexion injury. The University of Michigan, Highway Safety Research Institute, UM-HSRI-BI-75-6.
- Snyder, R.G.; Chaffin, D.B.; Schneider, L.W.; Foust, D.R.; Bowman, B.M.; Abdelnour, T.A.; and Baum, J.K. (1975b) Basic biomechanical properties of the human neck related to lateral hyperflexion injury. The University of Michigan, Highway Safety Research Institute, UM-HSRI-BI-75-4.
- Stoudt, H.W. (1978) Are people still getting bigger--who, where, and how much? SAE paper no. 780280.
- Stoudt, H.W.; Damon, A.; McFarland, R.; and Roberts, J. (1965) Weight, height, and selected body dimensions of adults. Vital and Health Statistics, Series 11, Number 8.
- Stoudt, H.W.; Damon, A.; McFarland, R.A.; and Roberts, J. (1970) Skinfolts, body girths, biacromial diameter, and selected anthropometric indices of adults. Vital and Health Statistics, Series 11, Number 35.
- Tokyo Metropolitan University, Physical Fitness Laboratory. (1980) Physical Fitness Standardards of Japanese People. 3rd ed.
- White, R.M. (1975) Anthropometric measurements on selected populations of the world. Ethnic Variables in Human Factors Engineering, edited by A. Chapanis, pp. 31-46. John Hopkins University Press, Baltimore.
- Young, J.W.; Chandler, R.F.; Snow, C.C.; Robinette, K.M.; Zehner, G.F.; and Lofberg, M.S. (1983) Anthropometric and mass distribution characteristics of adult female body segments (Draft Report). Federal Aviation Administration, Civil Aeromedical Institute.

APPENDICES

	<u>Page</u>
A. In-Vehicle Photographs and Measurement Results	A - 1
B. Vehicle Package Dimensions and J826 H-Point Procedures	B - 1
C. Development of Vehicle Seat Buck Parameters	C - 1
D. Distributions of Age, Stature, Weight, Sitting Height, and Buttock-Knee Length for Phase III Subjects	D - 1
E. Standard Anthropometry Definitions	E - 1
F. Photographs of Phase III Measurements in the Contoured Hardseats	F - 1
G. Surface Landmark Definitions	G - 1
H. Anthropometric Measurements in Contoured Hardseats . .	H - 1
I. Phase III Measurement Results (Statistics)	I - 1
J. Photographs of Clay Model Development and Fabrication of Epoxy/Fiberglass Shells	J - 1
K. Photographs of Surface Shells with Surface Landmark Identification Numbers	K - 1
L. Comparisons of Desired and Actual Values for Seated Anthropometry and Surface Landmark Coordinates for the Surface Shells	L - 1

APPENDIX A

IN-VEHICLE PHOTOGRAPHS AND MEASUREMENT RESULTS

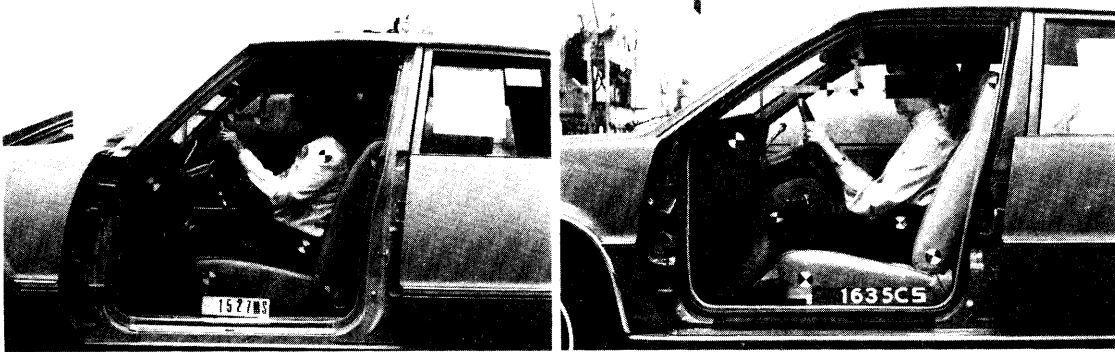
This appendix contains samples of side-view photographs of subjects sitting in the four different vehicles and also the summary statistics for in-vehicle, Phase I measurement data. Figures A-1 and A-2 show examples of subjects from all four subject groups sitting in the four different vehicles in the "standardized normal driving posture." Photographs are arranged in columns by vehicle, as indicated in the legend, and in each case the subjects are ordered from top to bottom--small female, mid-sized female, mid-sized male, and large male. Figures A-3 and A-4 compare the preferred seated positions of eight mid-sized male subjects sitting in the Chevy Malibu and Ford Escort vehicles, respectively, and demonstrate the rather wide range of seat positions and postures obtained within a subject group of narrowly defined stature and weight.

Table A.1 gives the summary statistics for in-vehicle measurements averaged across all subjects. Tables A.2 and A.3 give these statistics by subject group and vehicle, while Table A.4 presents the data for the sixteen subject-group/vehicle-type conditions.

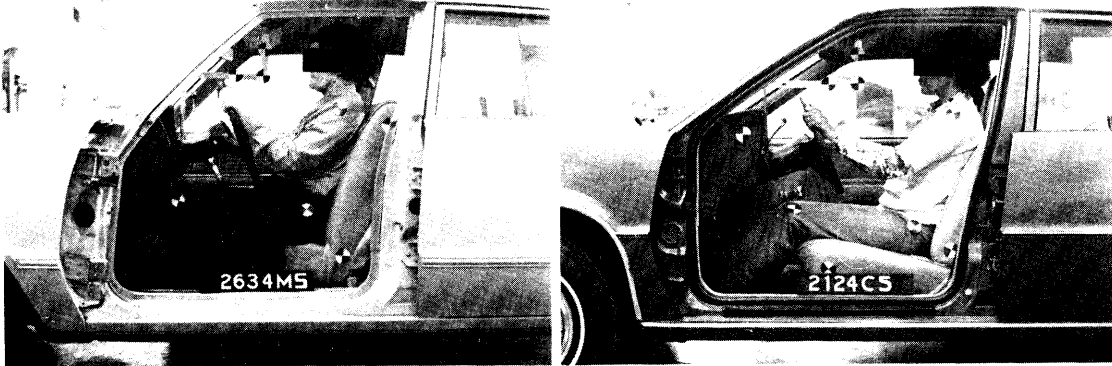


FIGURE A-1. Examples of the "standardized normal driving posture" for the four subject groups in the Ford Escort and Plymouth Champ.

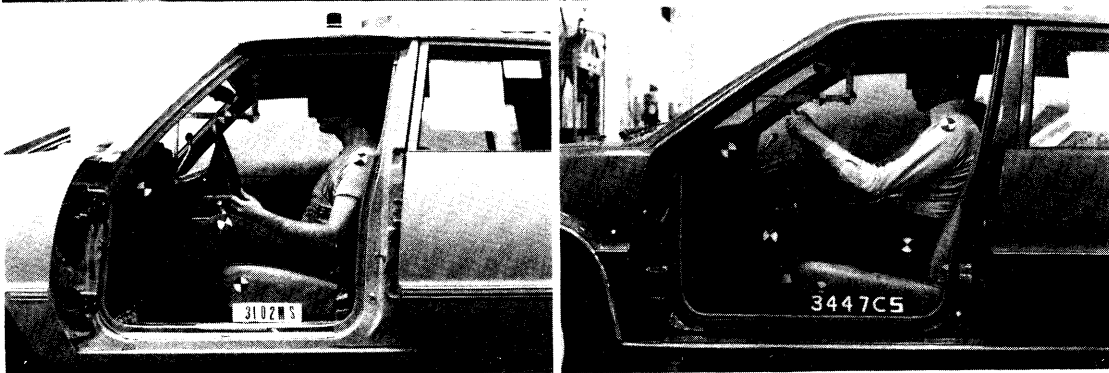
Small Female



Mid-Sized Female



Mid-Sized Male



Large Male



Chevrolet Malibu

Chevrolet Citation

FIGURE A-2. Examples of the "standardized normal driving posture" for the four subject groups in the Chevrolet Malibu and Chevrolet Citation.

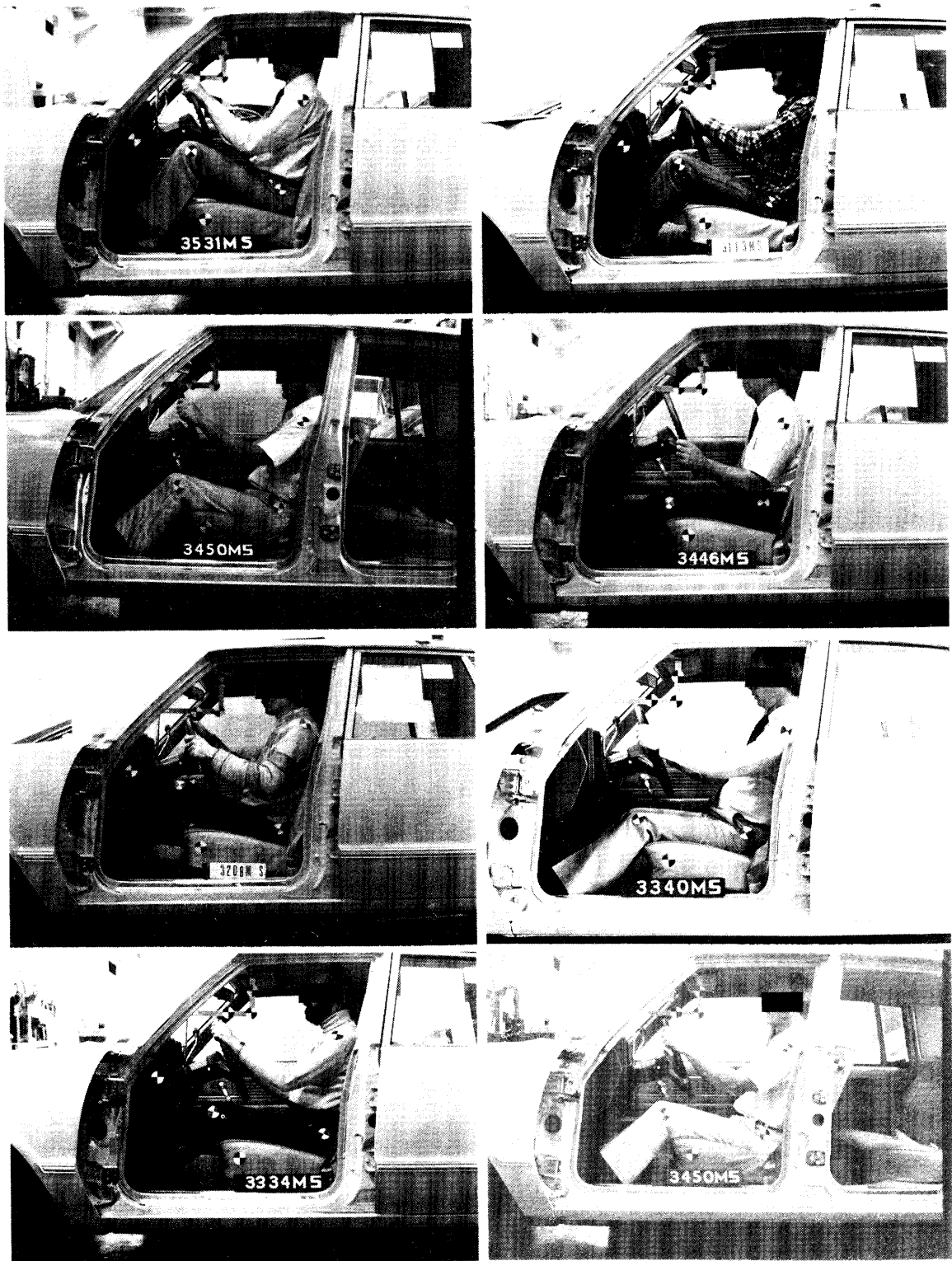


FIGURE A-3. Examples of the "standardized normal driving posture" for eight mid-sized males in the Chevrolet Malibu.



FIGURE A-4. Examples of the "standardized normal driving posture" for eight mid-sized males in the Ford Escort.

TABLE A.1

MEAN VALUES OF PHASE I MEASUREMENTS FOR ALL SUBJECTS COMBINED

Measurement	N	Min.	Max.	Mean	S.D.
Age (years)	177	18.0	72.0	36.9	12.8
Stature (cm)	177	146.0	189.6	168.1	12.2
Weight (kg)	177	43.1	112.1	71.0	18.6
Erect Sitting Height (cm)	177	77.6	103.7	89.0	5.8
Buttock Knee Length (cm)	177	45.5	69.8	58.3	4.5
Shoe Heel Thickness (cm)	175	1.2	10.0	3.9	1.7
Detent	177	1.0	13.0	5.8	3.5
Bolt to Heel (cm)	177	34.3	58.4	45.4	5.0
Foot Pitch (Deg to Horiz)	177	35.0	85.0	57.5	8.6
Foot Rotation (Deg to Vert)	177	0.0	48.0	10.8	8.3

TABLE A.2
MEAN VALUES OF PHASE I MEASUREMENTS BY SUBJECT GROUP

Measurement by Group	N	Min.	Max.	Mean	S.D.
Small Female:					
Age (years)	41	18.0	65.0	36.0	14.6
Stature (cm)	41	146.0	155.0	151.6	2.5
Weight (kg)	41	43.1	49.9	47.3	1.7
Erect Sitting Height (cm)	41	77.6	86.2	81.8	1.9
Buttock Knee Length (cm)	41	49.2	57.9	52.7	2.0
Shoe Heel Thickness (cm)	40	1.3	8.7	4.6	2.0
Detent	41	1.0	5.5	1.7	1.2
Bolt to Heel (cm)	41	34.3	58.4	45.7	5.2
Foot Pitch (Deg to Horiz)	41	41.0	76.0	56.9	8.4
Foot Rotation (Deg to Vert)	41	5.0	23.0	7.1	3.8
Mid-Sized Female:					
Age (years)	50	18.0	72.0	40.3	12.8
Stature (cm)	50	158.8	165.8	162.7	1.9
Weight (kg)	50	58.8	68.2	63.2	2.2
Erect Sitting Height (cm)	50	79.3	92.5	86.7	2.5
Buttock Knee Length (cm)	50	45.5	60.8	56.9	2.5
Shoe Heel Thickness (cm)	50	1.5	10.0	4.4	2.1
Detent	50	1.0	9.0	4.6	2.0
Bolt to Heel (cm)	50	38.1	55.9	46.1	4.6
Foot Pitch (Deg to Horiz)	50	46.0	85.0	58.1	7.2
Foot Rotation (Deg to Vert)	50	0.0	24.0	7.0	4.3
Mid-Sized Male:					
Age (years)	53	18.0	60.0	36.2	12.8
Stature (cm)	53	171.2	178.2	174.7	1.9
Weight (kg)	53	71.7	82.6	77.5	2.7
Erect Sitting Height (cm)	53	86.4	95.8	91.9	2.5
Buttock Knee Length (cm)	53	56.1	65.8	60.2	2.0
Shoe Heel Thickness (cm)	52	1.2	6.5	3.2	0.8
Detent	53	4.3	13.0	7.4	2.3
Bolt to Heel (cm)	53	35.6	54.1	45.1	4.7
Foot Pitch (Deg to Horiz)	53	35.0	85.0	59.0	10.1
Foot Rotation (Deg to Vert)	53	5.0	39.0	12.1	7.4
Large Male:					
Age (years)	33	18.0	54.0	34.1	9.3
Stature (cm)	33	182.4	189.6	186.1	1.9
Weight (kg)	33	95.0	112.1	101.8	4.7
Erect Sitting Height (cm)	33	91.8	103.7	96.9	2.6
Buttock Knee Length (cm)	33	60.0	69.8	64.4	1.9
Shoe Heel Thickness (cm)	33	1.9	4.7	3.1	0.7
Detent	33	6.0	13.0	10.1	2.2
Bolt to Heel (cm)	33	35.6	54.6	44.6	5.6
Foot Pitch (Deg to Horiz)	33	44.0	75.0	55.0	7.9
Foot Rotation (Deg to Vert)	33	5.0	48.0	19.0	11.5

TABLE A.3
MEAN VALUES OF PHASE I MEASUREMENTS BY VEHICLE

Measurement by Vehicle	N	Min.	Max.	Mean	S.D.
<u>Malibu:</u>					
Age (years)	44	18.0	72.0	40.2	12.2
Stature (cm)	44	147.1	189.6	168.4	12.6
Weight (kg)	44	45.3	108.4	71.4	19.2
Erect Sitting Height (cm)	44	79.2	101.1	89.3	5.7
Buttock Knee Length (cm)	44	49.6	66.9	58.5	4.5
Shoe Heel Thickness (cm)	43	1.2	7.5	3.5	1.4
Detent	44	1.0	9.0	4.8	2.7
Bolt to Heel (cm)	44	43.2	58.4	50.8	3.2
Foot Pitch (Deg to Horiz)	44	41.0	73.0	55.0	7.1
Foot Rotation (Deg to Vert)	44	5.0	34.0	9.9	7.3
<u>Citation:</u>					
Age (years)	44	18.0	65.0	37.5	12.7
Stature (cm)	44	149.9	187.5	168.0	11.6
Weight (kg)	44	43.1	111.2	71.1	19.1
Erect Sitting Height (cm)	44	80.0	99.1	88.5	5.6
Buttock Knee Length (cm)	44	45.5	66.6	58.3	4.8
Shoe Heel Thickness (cm)	44	1.5	8.0	3.5	1.5
Detent	44	1.0	9.0	4.7	2.8
Bolt to Heel (cm)	44	38.1	54.1	46.3	3.5
Foot Pitch (Deg to Horiz)	44	35.0	85.0	63.1	9.5
Foot Rotation (Deg to Vert)	44	0.0	48.0	12.5	9.1
<u>Escort:</u>					
Age (years)	47	18.0	64.0	34.7	12.4
Stature (cm)	47	146.0	189.5	168.9	12.7
Weight (kg)	47	44.5	112.1	72.2	18.9
Erect Sitting Height (cm)	47	77.6	100.6	89.6	5.8
Buttock Knee Length (cm)	47	49.2	69.8	58.9	4.6
Shoe Heel Thickness (cm)	47	2.2	8.7	4.1	1.6
Detent	47	1.0	13.0	7.5	4.6
Bolt to Heel (cm)	47	34.3	46.5	40.9	3.5
Foot Pitch (Deg to Horiz)	47	43.0	85.0	54.1	7.7
Foot Rotation (Deg to Vert)	47	5.0	41.0	10.6	8.6
<u>Champ:</u>					
Age (years)	42	18.0	68.0	35.3	13.5
Stature (cm)	42	148.5	189.0	166.9	12.2
Weight (kg)	42	44.5	105.0	69.1	17.6
Erect Sitting Height (cm)	42	79.3	103.7	88.6	6.1
Buttock Knee Length (cm)	42	49.5	65.5	57.5	4.2
Shoe Heel Thickness (cm)	41	1.8	10.0	4.4	2.1
Detent	42	1.0	10.0	6.1	2.8
Bolt to Heel (cm)	42	36.3	50.8	43.9	3.3
Foot Pitch (Deg to Horiz)	42	45.0	76.0	58.0	7.1
Foot Rotation (Deg to Vert)	42	5.0	43.0	10.2	8.3

TABLE A.4
MEAN VALUES OF PHASE I MEASUREMENTS BY GROUP/VEHICLE

Measurement by Group/Vehicle	N	Min.	Max.	Mean	S.D.
<u>SMALL FEMALE/Malibu:</u>					
Age (years)	11	23.0	62.0	43.2	14.6
Stature (cm)	11	147.1	155.0	151.7	2.7
Weight (kg)	11	45.3	49.0	47.4	1.1
Erect Sitting Height (cm)	11	79.2	85.2	82.2	1.8
Buttock Knee Length (cm)	11	49.6	57.9	52.9	2.4
Shoe Heel Thickness (cm)	10	1.3	7.5	3.9	2.1
Detent	11	1.0	2.0	1.4	0.5
Bolt to Heel (cm)	11	43.2	58.4	50.9	4.2
Foot Pitch (Deg to Horiz)	11	41.0	64.0	53.2	8.4
Foot Rotation (Deg to Vert)	11	5.0	12.0	6.1	2.2
<u>Small Female/Citation:</u>					
Age (years)	10	19.0	65.0	36.0	16.8
Stature (cm)	10	149.9	155.0	152.6	1.6
Weight (kg)	10	43.1	49.7	46.9	2.1
Erect Sitting Height (cm)	10	80.0	83.6	81.4	1.2
Buttock Knee Length (cm)	10	50.3	56.8	53.3	2.0
Shoe Heel Thickness (cm)	10	2.0	8.0	4.3	2.0
Detent	10	1.0	2.3	1.3	0.5
Bolt to Heel (cm)	10	43.2	50.8	46.4	2.7
Foot Pitch (Deg to Horiz)	10	58.0	74.0	62.3	4.7
Foot Rotation (Deg to Vert)	10	5.0	23.0	9.8	6.6
<u>Small Female/Escort:</u>					
Age (years)	10	19.0	60.0	32.3	12.9
Stature (cm)	10	146.0	155.0	150.9	3.2
Weight (kg)	10	44.5	49.9	47.5	2.0
Erect Sitting Height (cm)	10	77.6	85.0	81.4	2.5
Buttock Knee Length (cm)	10	49.2	56.5	52.6	1.9
Shoe Heel Thickness (cm)	10	3.0	8.7	4.9	1.9
Detent	10	1.0	3.5	1.4	0.9
Bolt to Heel (cm)	10	34.3	46.5	41.0	4.5
Foot Pitch (Deg to Horiz)	10	43.0	67.0	55.1	7.9
Foot Rotation (Deg to Vert)	10	5.0	8.0	6.0	1.2
<u>Small Female/Champ:</u>					
Age (years)	10	18.0	59.0	31.8	12.6
Stature (cm)	10	148.5	154.7	151.4	2.2
Weight (kg)	10	44.5	49.1	47.3	1.6
Erect Sitting Height (cm)	10	79.5	86.2	82.1	2.3
Buttock Knee Length (cm)	10	49.5	53.7	51.9	1.4
Shoe Heel Thickness (cm)	10	2.0	8.0	5.2	2.0
Detent	10	1.0	5.5	2.9	1.9
Bolt to Heel (cm)	10	36.3	46.5	43.8	3.4
Foot Pitch (Deg to Horiz)	10	45.0	76.0	57.3	10.0
Foot Rotation (Deg to Vert)	10	5.0	10.0	6.8	1.9

TABLE A.4
PHASE I MEAN VALUES BY GROUP/VEHICLE (Continued)

Measurement by Group/Vehicle	N	Min.	Max.	Mean	S.D.
<u>MID-SIZED FEMALE/Malibu:</u>					
Age (years)	10	32.0	72.0	42.3	11.6
Stature (cm)	10	158.8	164.6	162.5	1.8
Weight (kg)	10	60.0	65.6	62.4	1.6
Erect Sitting Height (cm)	10	82.6	89.8	86.6	1.9
Buttock Knee Length (cm)	10	54.2	60.3	57.3	2.0
Shoe Heel Thickness (cm)	10	2.0	7.5	3.7	1.7
Detent	10	1.0	5.0	3.6	1.4
Bolt to Heel (cm)	10	47.0	55.9	52.1	2.4
Foot Pitch (Deg to Horiz)	10	52.0	66.0	57.5	5.1
Foot Rotation (Deg to Vert)	10	5.0	15.0	6.8	3.3
<u>Mid-Sized Female/Citation:</u>					
Age (years)	12	24.0	55.0	41.6	10.9
Stature (cm)	12	159.0	165.3	162.2	2.1
Weight (kg)	12	59.5	66.3	62.9	2.1
Erect Sitting Height (cm)	12	83.5	90.5	86.0	2.2
Buttock Knee Length (cm)	12	45.5	60.8	55.9	4.2
Shoe Heel Thickness (cm)	12	1.5	7.7	3.7	1.8
Detent	12	1.0	6.3	3.3	1.6
Bolt to Heel (cm)	12	38.1	50.8	47.5	3.5
Foot Pitch (Deg to Horiz)	12	52.0	85.0	63.9	8.7
Foot Rotation (Deg to Vert)	12	0.0	24.0	8.4	7.2
<u>Mid-Sized Female/Escort:</u>					
Age (years)	14	18.0	64.0	37.6	13.8
Stature (cm)	14	160.6	165.7	163.6	1.6
Weight (kg)	14	60.6	66.7	64.1	2.0
Erect Sitting Height (cm)	14	84.0	91.9	87.8	2.0
Buttock Knee Length (cm)	14	54.9	59.9	57.2	1.3
Shoe Heel Thickness (cm)	14	2.5	7.5	4.5	1.9
Detent	14	1.0	9.0	5.6	2.2
Bolt to Heel (cm)	14	38.1	46.5	42.0	3.3
Foot Pitch (Deg to Horiz)	14	46.0	61.0	53.1	5.3
Foot Rotation (Deg to Vert)	14	5.0	9.0	5.5	1.1
<u>Mid-Sized Female/Champ:</u>					
Age (years)	14	20.0	68.0	40.4	14.9
Stature (cm)	14	159.3	165.8	162.5	2.1
Weight (kg)	14	58.8	68.2	63.1	2.8
Erect Sitting Height (cm)	14	79.3	92.5	86.2	3.2
Buttock Knee Length (cm)	14	52.0	60.2	57.3	2.0
Shoe Heel Thickness (cm)	14	2.0	10.0	5.5	2.4
Detent	14	3.0	7.8	5.4	1.4
Bolt to Heel (cm)	14	41.4	49.5	44.8	2.4
Foot Pitch (Deg to Horiz)	14	50.0	66.0	58.4	5.4
Foot Rotation (Deg to Vert)	14	5.0	17.0	7.5	3.5

TABLE A.4
PHASE I MEAN VALUES BY GROUP/VEHICLE (Continued)

Measurement by Group/Vehicle	N	Min.	Max.	Mean	S.D.
<u>MID-SIZED MALE/Malibu:</u>					
Age (years)	15	18.0	55.0	39.3	12.8
Stature (cm)	15	171.2	178.1	175.1	2.1
Weight (kg)	15	74.2	82.6	78.3	2.2
Erect Sitting Height (cm)	15	88.5	95.0	92.2	2.0
Buttock Knee Length (cm)	15	56.1	63.3	60.1	1.7
Shoe Heel Thickness (cm)	15	1.2	4.0	3.1	0.7
Detent	15	4.8	8.0	6.5	1.2
Bolt to Heel (cm)	15	44.4	53.3	49.5	2.8
Foot Pitch (Deg to Horiz)	15	43.0	73.0	55.6	8.5
Foot Rotation (Deg to Vert)	15	5.0	20.0	9.3	5.2
<u>Mid-Sized Male/Citation:</u>					
Age (years)	14	20.0	58.0	35.7	11.9
Stature (cm)	14	171.7	176.7	174.5	1.7
Weight (kg)	14	72.6	82.3	77.2	3.0
Erect Sitting Height (cm)	14	86.4	95.4	91.3	3.2
Buttock Knee Length (cm)	14	56.8	63.7	60.4	1.9
Shoe Heel Thickness (cm)	14	2.5	4.5	3.4	0.6
Detent	14	4.3	9.0	6.3	1.5
Bolt to Heel (cm)	14	41.4	54.1	46.7	3.3
Foot Pitch (Deg to Horiz)	14	35.0	80.0	65.8	10.8
Foot Rotation (Deg to Vert)	14	5.0	29.0	15.8	7.5
<u>Mid-Sized Male/Escort:</u>					
Age (years)	13	19.0	60.0	35.9	13.9
Stature (cm)	13	171.2	178.2	175.0	2.0
Weight (kg)	13	71.7	81.2	77.3	3.0
Erect Sitting Height (cm)	13	87.9	95.8	92.1	2.4
Buttock Knee Length (cm)	13	58.2	65.8	61.0	2.0
Shoe Heel Thickness (cm)	13	2.2	6.5	3.5	1.0
Detent	13	5.5	13.0	9.9	2.7
Bolt to Heel (cm)	13	35.6	45.7	40.5	3.0
Foot Pitch (Deg to Horiz)	13	43.0	85.0	55.2	10.7
Foot Rotation (Deg to Vert)	13	5.0	39.0	13.7	9.9
<u>Mid-Sized Male/Champ:</u>					
Age (years)	11	18.0	57.0	32.9	13.6
Stature (cm)	11	171.7	177.0	174.1	1.9
Weight (kg)	11	73.1	81.2	76.8	2.5
Erect Sitting Height (cm)	11	89.0	94.5	92.2	2.4
Buttock Knee Length (cm)	11	57.2	63.5	59.0	1.9
Shoe Heel Thickness (cm)	10	1.8	4.5	2.9	0.8
Detent	11	5.3	10.0	7.4	1.6
Bolt to Heel (cm)	11	38.1	47.0	42.5	3.4
Foot Pitch (Deg to Horiz)	11	50.0	75.0	59.5	6.5
Foot Rotation (Deg to Vert)	11	5.0	17.0	9.5	4.0

TABLE A.4
PHASE I MEAN VALUES BY GROUP/VEHICLE (Continued)

Measurement by Group/Vehicle	N	Min.	Max.	Mean	S.D.
<u>LARGE MALE/Malibu:</u>					
Age (years)	8	21.0	43.0	35.1	7.5
Stature (cm)	8	183.9	189.6	186.4	1.9
Weight (kg)	8	97.8	108.4	102.6	4.2
Erect Sitting Height (cm)	8	93.8	101.1	96.9	2.4
Buttock Knee Length (cm)	8	62.1	66.9	64.7	2.0
Shoe Heel Thickness (cm)	8	1.9	4.7	3.3	0.9
Detent	8	6.0	9.0	8.0	1.2
Bolt to Heel (cm)	8	47.0	54.6	51.5	2.8
Foot Pitch (Deg to Horiz)	8	49.0	58.0	53.5	3.6
Foot Rotation (Deg to Vert)	8	5.0	34.0	20.1	9.7
<u>Large Male/Citation:</u>					
Age (years)	8	18.0	51.0	36.6	12.1
Stature (cm)	8	182.4	187.5	184.9	1.5
Weight (kg)	8	95.7	111.2	103.0	5.1
Erect Sitting Height (cm)	8	94.2	99.1	96.1	2.0
Buttock Knee Length (cm)	8	62.4	66.6	64.5	1.5
Shoe Heel Thickness (cm)	8	2.0	3.7	2.8	0.7
Detent	8	8.0	9.0	8.5	0.5
Bolt to Heel (cm)	8	38.1	50.8	43.9	4.1
Foot Pitch (Deg to Horiz)	8	46.0	75.0	58.1	12.1
Foot Rotation (Deg to Vert)	8	7.0	48.0	16.3	13.7
<u>Large Male/Escort:</u>					
Age (years)	10	22.0	44.0	31.4	7.4
Stature (cm)	10	183.0	189.5	186.5	2.3
Weight (kg)	10	95.3	112.1	101.6	5.7
Erect Sitting Height (cm)	10	94.6	100.6	97.0	2.2
Buttock Knee Length (cm)	10	60.0	69.8	64.6	2.7
Shoe Heel Thickness (cm)	10	2.2	4.4	3.5	0.6
Detent	10	13.0	13.0	13.0	0.0
Bolt to Heel (cm)	10	35.6	44.4	39.6	3.1
Foot Pitch (Deg to Horiz)	10	44.0	64.0	52.8	6.7
Foot Rotation (Deg to Vert)	10	8.0	41.0	18.4	9.9
<u>Large Male/Champ:</u>					
Age (years)	7	24.0	54.0	33.9	10.8
Stature (cm)	7	185.0	189.0	186.6	1.5
Weight (kg)	7	95.0	105.0	99.8	3.3
Erect Sitting Height (cm)	7	91.8	103.7	97.4	4.0
Buttock Knee Length (cm)	7	62.2	65.5	63.8	1.1
Shoe Heel Thickness (cm)	7	1.9	3.3	2.9	0.5
Detent	7	10.0	10.0	10.0	0.0
Bolt to Heel (cm)	7	38.1	50.8	44.3	4.3
Foot Pitch (Deg to Horiz)	7	49.0	68.0	56.1	7.2
Foot Rotation (Deg to Vert)	7	5.0	43.0	21.9	14.6

APPENDIX B

VEHICLE PACKAGE DIMENSIONS AND J826 H-POINT PROCEDURES

This appendix presents the vehicle package dimensions and SAE J826 H-point procedures used to establish and validate the seat buck configurations used in Phase II measurements. Each vehicle seat was bolted to a 3/4-inch-thick plywood mounting board by which it could be fastened to the buck platform. Hardwood spacers were used under the seat track mounting brackets to achieve the proper seat orientations. These spacer heights were determined from information on vehicle package drawings for the Malibu, Citation, and Escort vehicles. Mitsubishi Motor Company, Inc. provided the necessary dimensions to configure the Champ buck but package drawings were not obtained for this vehicle. Tables B.1 through B.3 provide some of the important package dimensions and coordinates used while Table B.4 gives vehicle and buck dimensions involved in mounting the seat tracks to the plywood mounting boards and in locating the buck steering wheel relative to these boards. For the Malibu, Citation, and Escort the rear-track mounting brackets were bolted directly to the 3/4-inch board without spacers. The vehicle Z coordinates of these brackets relative to the Z coordinates of the accelerator heel points (see Table B.2) determined the heights of the heel spacers needed. The vehicle X coordinates of the front-seat track mounting bolts and the distances of these bolts to the front of the 3/4-inch mounting boards were used to determine the vehicle X coordinates of the fronts of these mounting boards. From these values, the coordinates of the steering wheel centers on the buck were determined. A similar procedure was used for the Plymouth Champ except that the seat track mounting was more complicated and dimensions provided by Mitsubishi, rather than vehicle coordinates, were used.

With the seats bolted to the buck platform by the removable 3/4-inch mounting boards, the J826 H-point procedures were used to check the seat orientations against the vehicle H-point design specifications. An H-point machine was obtained and the procedures listed in Table B.5 were practiced and applied with assistance from Ford Company personnel. Table B.6 compares the design specifications for each vehicle seat with measured values.

TABLE B.1
VEHICLE DESIGN SPECIFICATIONS

Design Variable	Malibu	Citation	Escort	Champ
Number of detents	9	10	13	10
Design H-point travel, mm (L17)	172.0	192.0	152.0	180.0
Design H-point rise, mm (H58)	26.0	28.0	22.0	N.A
Detent space, mm	21.5	21.3	12.7	20.0
Steering wheel angle, deg. (H18)	19.5	22.0	26.3	25.7
H-point to accel. heel point horizontal distance, mm (L53)	891.0	866.0	840.0	830.0
H-point to accel. heel point vertical distance, mm (H30)	229.0	258.0	261.0	255.0

TABLE B.2
COORDINATES OF STEERING WHEEL AND SEAT TRACK MOUNTING BOLTS
IN VEHICLE REFERENCE SYSTEMS
(Obtained from Vehicle Package Drawings)

Component	Malibu	Citation	Escort
Heel point X	2197	2272	2265
Heel point Z	446	195	417
H-point X	3088	3138	3101
H-point Z	675	453	678
Steering wheel center X	2749	2770	2734
Steering wheel center Z	1057	826	1046
Steering wheel lower rim X	2793	2820	2800
Steering wheel lower rim Z	873	647	869
Seat track front bolt X	2762	2770	2685
Seat track front bolt Z	474	233	440
Seat track rear bolt X	3074	3117	3107
Seat track rear bolt Z	426	197	409

TABLE B.3

SEAT TRACK MOUNTING DIMENSIONS FOR PLYMOUTH CHAMP
(Obtained from Mitsubishi, Inc.)

Seat Track Bolt	Distance from Heel Point (mm)	
	X	Z
Front Anchor Bolt: Right	470	27
Left	470	8
Rear Anchor Bolt: Right	816	18
Left	840	-3 (angled)

TABLE B.4

VEHICLE AND BUCK DIMENSIONS USED TO LOCATE STEERING WHEEL CENTER
RELATIVE TO 3/4-INCH SEAT MOUNTING BOARD

Dimension	Malibu		Citation		Escort		Champ	
	mm	in	mm	in	mm	in	mm	in
Rear-track spacer height	0	0.0	0	0.0	0	0.0	Rt. 36 Lt. 15	1.4 0.6
Front-track spacer height	49	1.9	36	1.4	31	1.2	Lt. 45 Rt. 26	1.8 1.0
Heel spacer height	20	0.8	2	0.1	8	0.3	18	0.7
Front seat track bolt to front of 3/4" mounting board	133	5.3	127	5.0	64	2.5	127	5.0
Vehicle X-coordinate of front of 3/4" mounting board	2628	--	2643	--	2622	--	N.A.	--
Steering wheel center to behind front of 3/4" board	121	4.8	127	5.0	113	4.4	112*	4.4
Ht. of steering wheel center above accel. heel point	611	24.1	631	24.8	629	24.8	617	24.3
Ht. of steering wheel center above 3/4" mounting board	631	24.8	629	24.8	637	25.1	635	25.0

*X distance of steering wheel center from accelerator heel point is 455 mm (17.9 in.) which puts the steering wheel center 15 mm (470-455) forward of the seat-track mounting bolt.

TABLE B.5
DESCRIPTION OF H-POINT PROCEDURE USED
TO CALIBRATE SEAT BUCKS

1. Set H-point machine without weights and legs on muslin cloth on seat and wiggle to level bubble.
 2. Attach legs with back angle set to 87° (82° for Champ) and lengths to 95th percentile (50th percentile for Champ) and set heel point-to-front-bolt-hole distance per vehicle specifications.
 3. Put calf weights on.
 4. Put thigh weights on.
 5. Pull torso forward.
 6. Push twice at thigh-hip juncture with 22-pound force as near to horizontal as possible.
 7. Put torso back into seat holding T-bar.
 8. Put hip weights on.
 9. Put back weights on alternately.
 10. Bring torso forward holding T-bar and let rest.
 11. Rock gently side to side to level bubble.
 12. Put torso back into seat while holding T-bar and watching level.
 13. Bring torso forward and repeat steps 11 and 12.
 14. Set back angle level.
 15. Recheck heel position to insure it has not moved.
 16. Read knee, hip, and back angles.
 17. Measure horizontal and vertical distances to H-point using anthropometer, levels, and square.
 18. Take photographs.
 19. Done.
-

TABLE B.6

COMPARISON OF VEHICLE H-POINT DESIGN SPECIFICATIONS
ACHIEVED IN VEHICLE SEAT BUCKS WITH ACTUAL VALUES

Vehicle or H-Point Dimension	Malibu*		Citation*		Escort*		Champ**	
	Design	Actual	Design	Actual	Design	Actual	Design	Actual
	Accel. heel point to front seat track bolt, mm	565.0	565.0	498.0	498.0	420.0	420.0	470.0
Foot angle, deg. (L46)	87.0	87.0	87.0	87.0	87.0	87.0	82.0	82.0
Heel space used, in.	--	3/4	--	0	--	3/8	--	3/4
H-point to heel point horiz. distance, mm (L53)	891	915	866	854	840	828	830	830
H-point to heel point vert. distance, mm (H30)	229	225	258	260	261	263	255	255
Knee angle, deg. (L44)	131.0	137.0	126.7	127.0	121.7	121.8	132.0	132.0
Hip angle, deg. (L42)	99.6	98.0	98.0	97.0	94.6	95.0	100.0	100.0
Back angle, deg. (L40)	26.5	23.0	25.0	25.0	24.0	25.0	23.0	23.0

*H-point machine uses 95th percentile leg and thigh lengths.

**H-point machine uses 50th percentile leg and thigh lengths.

NOTE: All measured values are within expected tolerance to design specifications.

APPENDIX C

DEVELOPMENT OF VEHICLE SEAT BUCK PARAMETERS

The laboratory seating bucks used in Phase II measurements were developed for the four vehicle seats using vehicle design specifications that describe the seat configurations in the vehicle, and Phase I measurement results that describe the preferred position of the seated drivers (subjects). Appendix B describes the vehicle seating specifications and procedures used to simulate the vehicle seating geometry. This Appendix describes the methodology for utilizing the Phase I (in-vehicle) measurements to complete the vehicle buck configurations for Phase II testing.

While the proportions of leg and torso lengths within each subject group of well-defined stature were known to show considerable variation, a decision was made to configure the buck seat/toeboard geometry according to the average in-vehicle measurement data obtained for each group/vehicle condition. For example, the Malibu seat and toeboard for small females were positioned relative to each other using the average seat detent and heel position information obtained in Phase I for the eleven small females who sat in the Malibu vehicle. The alternative approach was to individually position the seat and toeboard according to each subject's in-vehicle data. While this would have resulted in a more accurate "fit" of Phase II subjects to the buck configuration, it would have been more complicated to implement. More importantly, it would have ignored most of the in-vehicle measurement data collected in Phase I since only eight of the subjects from each group were used in Phase II (i.e., two per vehicle seat) and it would have also increased the difficulty of the seat casting merging process. Furthermore, this approach would have had little ultimate value since the measurement plan called for collecting the primary sets of data in the hardseat bucks which, by definition, are averages across vehicles and subjects.

With each vehicle seat attached to a separate and removable plywood mounting board according to vehicle dimensions and J826 H-point validations, the task at hand was to determine the appropriate position of the seats relative to the toeboard as well as the design (i.e., angle) of the toeboard itself. While the basic information needed was

contained in the Phase I measurement data, certain calculations were necessary to obtain the dimensions for the buck. Figure C-1 shows some of the basic features of the seating bucks described in greater detail below, while Table C.1 provides a glossary of abbreviated terms used to refer to the measured and calculated values involved.

Table C.2 shows the average measured and calculated values used to determine the distance from the toeboard heel point to the front-seat-track mounting bolt (a fiducial landmark in vehicle package drawings) for the sixteen subject-group/vehicle-type situations. HEELLOCs are the average of the measured distances from the front-seat track bolts to the subject's heels for the sample (N) of subjects in each group sitting in a particular vehicle. To determine the horizontal (fore-aft) location of the buck heel point relative to the seat-track anchor bolt, this distance needs to be adjusted for two reasons. First, since the subjects are barefoot in the buck, a correction factor is needed due to shoe heel thickness and foot pitch angle. The second adjustment is due to the fact that the average detent for each subject-group/vehicle-type is a non-integer value and the seat track must be set on a specific detent.

Figure C-2 illustrates the adjustments made due to shoe heel thickness (HTH) and foot pitch angle (FTPIT) to obtain a horizontal correction (HB) and a vertical correction (HHT). The HEELSHIFT due to detent round off is obtained by multiplying the dropped fraction by the DETENT SPACE. The results of the horizontal adjustment are the BOLT TO HEEL DISTANCES (which equal HEELLOC-HEELSHIFT). The vertical HEEL SPACER used in each buck configuration is a sum of the shoe heel thickness factor (HHT) and the FLOOR SPACER required to achieve the correct Z distance of accelerator heel point relative to H-point as determined by vehicle package drawings and H-point validation (see Appendix B). Table C.3 summarizes some of these measured and calculated buck dimensions for each situation and gives the horizontal and vertical buck heel positions in inches as well as centimeters. It also gives dimensional information on the location of the accelerator pedal relative to the floor and the midline of the seat, and the location and tilt of the steering wheel for each vehicle.

Since the BOLT TO HEEL distances and HEEL SPACERS had similar values for all subject groups in each vehicle, the average of the group values were used for that vehicle. Also, all values for foot pitch angle (FTPIT) for the sixteen cases were quite similar and so the overall average was used. The foot rotation angle showed somewhat more variability, the large males (group 4), and, to a lesser extent, the mid-sized males (group 3), having the larger values. Since the range was somewhat small in actual degrees, the overall average value of eleven degrees was used as a guideline for all subject-group/vehicle-type conditions in Phase II and Phase III testing. This was achieved by placing lines on the toeboard at the desired angle and instructing subjects to align their feet with these lines.

To estimate the lateral position of the heel relative to the seated driver centerline, the distances of the estimated accelerator pedal center to this centerline and the vehicle floor were measured and averaged for all vehicles. Figure C-3 shows the geometric calculation for obtaining the lateral position of the heel using a foot rotation angle of eleven degrees and resulting in a lateral distance from the centerline of 3.9 inches. Targets were placed on the buck heel spacers at these positions and subjects were requested to place their heels on the targets.

The height of the steering wheel center relative to the 3/4-inch mounting board was determined to be nearly identical for all vehicles and so the average value of twenty-five inches was used. To simplify the steering wheel tilt settings, two angles were used: twenty-one degrees for the Malibu and Citation, and twenty-six degrees for the Escort and the Champ. The steering wheel support was designed to provide steering wheel tilt about the wheel center so that the vertical and horizontal positions of the steering wheel center did not shift with changes in steering wheel tilt.

Table C.4 shows the final buck dimensions used for each of the vehicle seats. In the final Phase II buck configurations, the only subject group dependent parameter was the vehicle seat detent setting whose values are summarized for the sixteen subject-group/vehicle-type conditions in Table C.5.

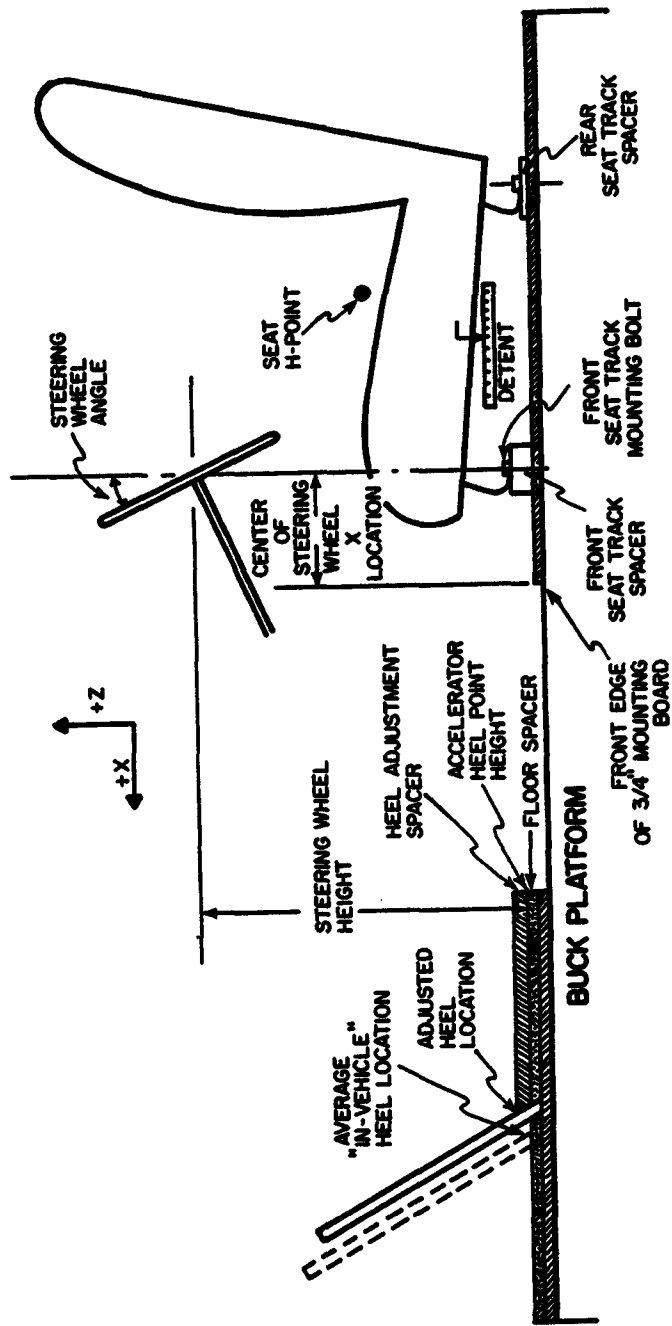


FIGURE C-1. Basic features of the vehicle seat buck.

TABLE C.1

GLOSSARY OF ABBREVIATED TERMS USED
IN SEAT BUCK DEVELOPMENT

Abbreviated Term	Definition
ACCEL C/L Y	Approximate lateral distance from center of accelerator pedal to centerline of driver seat position.
ACCEL C/L Z	Approximate vertical distance from center of accelerator pedal to vehicle floor.
BOLT TO HEEL DISTANCE	Computed horizontal distance from subject's bare heel to front-seat track mounting bolts (equals HEELLOC-HB+HEELSHIFT).
BUCK DETENT	Integer detent setting used for each subject-group/vehicle-type condition.
DETENT	Average seat track position selected in four trials (1=full forward).
DETENT SPACE	H-point horizontal travel between detents.
FLOOR SPACER	Height of floor spacer required to achieve correct Z distance between H-point and accelerator heel point in buck.
FTPIT	Foot pitch angle relative to horizontal measured on subject's right shoe placed on the undepressed accelerator pedal.
FTROT	Foot rotation angle relative to vertical measured on subject's right shoe placed on the undepressed accelerator pedal.
HB	Horizontal distance of bare heel behind shoe heel calculated from FTPIT and HTH.
HEELLOC	Horizontal distance of subject's heel position from front-seat-track mounting bolt measured in vehicle.
HTH	Thickness of subject's shoe from inside to bottom of heel.
HEELSHIFT	Horizontal (fore-aft) adjustment distance in heel position due to DETENT roundoff.

TABLE C.1
SEAT BUCK DEVELOPMENT GLOSSARY (Continued)

Abbreviated Term	Definition
HEELSPACER	Height of heel spacer required in vehicle seat buck (equal to the sum of FLOOR SPACER and HHT).
HHT	Vertical height of bare heel above vehicle floor calculated from FTPIT and HTH.
WHEEL HT	Vertical distance of steering wheel center above 3/4-inch seat mounting board.
WHEEL TILT	Steering wheel tilt angle to vertical.

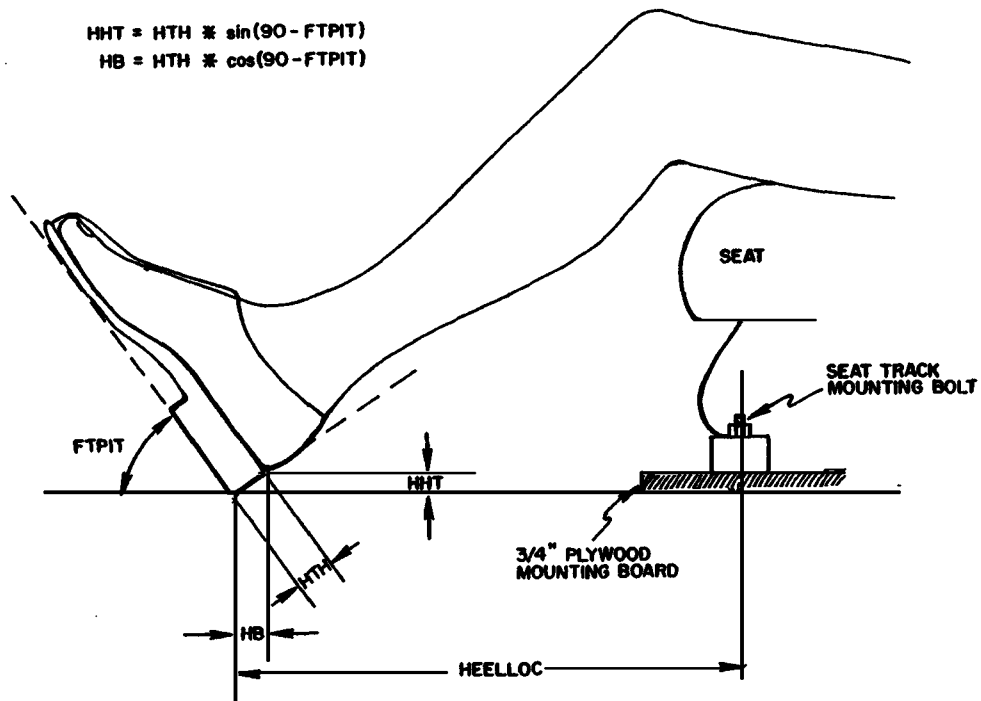


FIGURE C-2. Adjustments to heel position due to shoe heel thickness.

TABLE C.2
PARAMETER VALUES* USED IN DEVELOPMENT OF VEHICLE SEAT BUCKS

Vehicle and Group	N	Mean Values of Measured Variables					Calculated Parameter Values						
		HEELDC	FTPIT	DETENT	DETENT SPACE	HITH	BUCK DETENT	HEEL SHIFT	HB	BOLT TO HEEL DIST	HHT	FLOOR SPACER	HEEL SPACER
Malibu:													
Small Female	11	50.9	53	1.4	2.15	3.87	1	+0.8	3.1	48.6	2.3	2.0	4.3
Mid-Sized Female	10	52.1	57	3.6	2.15	3.73	3	+1.3	3.1	50.3	2.0	2.0	4.0
Mid-Sized Male	15	49.5	56	6.5	2.15	3.10	6	+1.0	2.6	47.9	1.7	2.0	3.7
Large Male	8	51.5	54	8.0	2.15	3.25	8	+0.1	2.6	49.0	1.9	2.0	3.9
Citation:													
Small Female	10	46.4	62	1.3	2.13	4.26	1	+0.7	3.8	43.3	2.0	0.0	2.0
Mid-Sized Female	12	47.9	64	3.3	2.13	3.92	3	+0.6	3.5	45.0	1.7	0.0	1.7
Mid-Sized Male	14	46.7	66	6.3	2.13	3.36	6	+0.6	3.1	44.2	1.4	0.0	1.4
Large Male	8	43.9	58	8.5	2.13	2.76	8	+1.1	2.3	42.6	1.5	0.0	1.5
Escort:													
Small Female	10	41.0	55	1.4	1.27	4.89	1	+0.5	4.0	37.5	2.8	0.8	3.6
Mid-Sized Female	14	42.0	53	5.6	1.27	4.50	6	-0.5	3.6	37.9	2.7	0.8	3.5
Mid-Sized Male	13	40.5	55	9.9	1.27	3.50	10	-2.2	2.9	37.4	2.0	0.8	2.8
Large Male	10	39.6	57	13.0	1.27	3.48	13	0.0	2.9	36.7	1.9	0.8	2.7
Champ:													
Small Female	10	43.8	57	2.9	2.00	5.20	2	+1.7	4.4	41.1	2.8	1.8	4.6
Mid-Sized Female	14	44.8	58	5.4	2.00	5.50	5	+0.8	4.7	40.9	2.9	1.8	4.7
Mid-Sized Male	11	42.5	59	7.4	2.00	2.94	7	+0.7	2.5	40.7	1.5	1.8	3.3
Large Male	7	44.3	56	10.0	2.00	2.94	10	0.0	2.4	41.9	1.6	1.8	3.4

*All distances in centimeters.

TABLE C.3
MEAN VALUES FOR MEASURED AND CALCULATED PARAMETERS USED IN SEAT BUCK DEVELOPMENT

Vehicle and Group	N	FTPIT (Deg)	FTROT (Deg)	HEEL TO HEEL DIST		HEEL SPACER		BUCK DETENT	ACCEL C/L Y (In)	ACCEL C/L Z (In)	WHEEL HT (In)	WHEEL TILT (Deg)
				(cm)	(In)	(cm)	(In)					
<u>Malibu:</u>												
Small Female	11	53	6	48.6	19.1	4.3	1.7	1	3.0	6.0	24.8	19.5
Mid-Sized Female	10	57	7	50.3	19.8	4.0	1.6	3				
Mid-Sized Male	15	56	9	47.9	18.9	3.7	1.5	6				
Large Male	8	54	20	49.0	19.3	3.9	1.5	8				
<u>Citation:</u>												
Small Female	10	62	10	43.3	17.0	2.0	0.8	1	7.5	6.0	24.8	22.0
Mid-Sized Female	12	64	8	45.0	17.7	1.7	0.7	3				
Mid-Sized Male	14	66	16	44.2	17.4	1.4	0.6	6				
Large Male	8	58	16	42.6	16.8	1.5	0.6	8				
<u>Escort:</u>												
Small Female	10	55	6	37.5	14.8	3.6	1.4	1	5.0	5.0	25.1	26.3
Mid-Sized Female	14	53	5	37.9	14.9	3.5	1.4	6				
Mid-Sized Male	13	55	14	37.4	14.7	2.8	1.1	10				
Large Male	10	57	18	36.7	14.4	2.7	1.1	13				
<u>Champ:</u>												
Small Female	10	57	7	41.1	16.2	4.6	1.8	2	5.0	5.0	25.0	25.7
Mid-Sized Female	14	58	7	40.9	16.1	4.7	1.9	5				
Mid-Sized Male	11	59	9	40.7	16.0	3.3	1.3	7				
Large Male	7	50	22	41.9	16.5	3.4	1.3	10				

TABLE C.4

FINAL VEHICLE SEAT BUCK DIMENSIONS*

Vehicle	TOEBOARD PITCH: HORIZ. (Deg)	FOOT ROTATION: VERTICAL (Deg)	BOLT TO HEEL DIST (In)	HEEL SPACER (In)	HEEL DISTANCE from C/L (In)	WHEEL HT (In)	WHEEL TILT (Deg)
Malibu	58	11	19.3	1.50	3.9	25.0	21
Citation	58	11	17.2	.75	3.9	25.0	21
Escort	58	11	14.8	1.25	3.9	25.0	26
Champ	58	11	16.2	1.50	3.9	25.0	26

*See Table C.1 for definition of variables.

TABLE C.5

BUCK SEAT DETENT SETTINGS

Group	Malibu	Citation	Escort	Champ
Small Female	1	1	1	2
Mid-Sized Female	3	3	6	5
Mid-Sized Male	6	6	10	7
Large Male	8	8	13	10

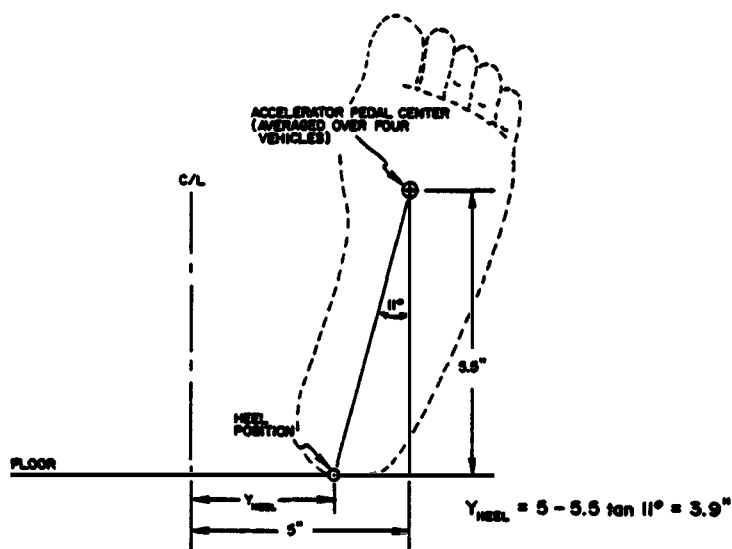


FIGURE C-3. Geometric estimation of heel position from centerline.

APPENDIX D

DISTRIBUTIONS OF AGE, STATURE, WEIGHT, SITTING HEIGHT, AND BUTTOCK-KNEE LENGTH FOR PHASE III SUBJECTS

The following pages show the frequency distributions by subject group for age, stature, weight, erect sitting height, and buttock-knee length for Phase III subjects. The numbers in the blocks correspond to the sequential subject numbers used in the study while the shaded blocks indicate subjects used in Phase II to develop the hardseat contours. Mean values of the Phase III distributions are indicated and compared with appropriate percentile values from the 1971-74 HANES data where available.

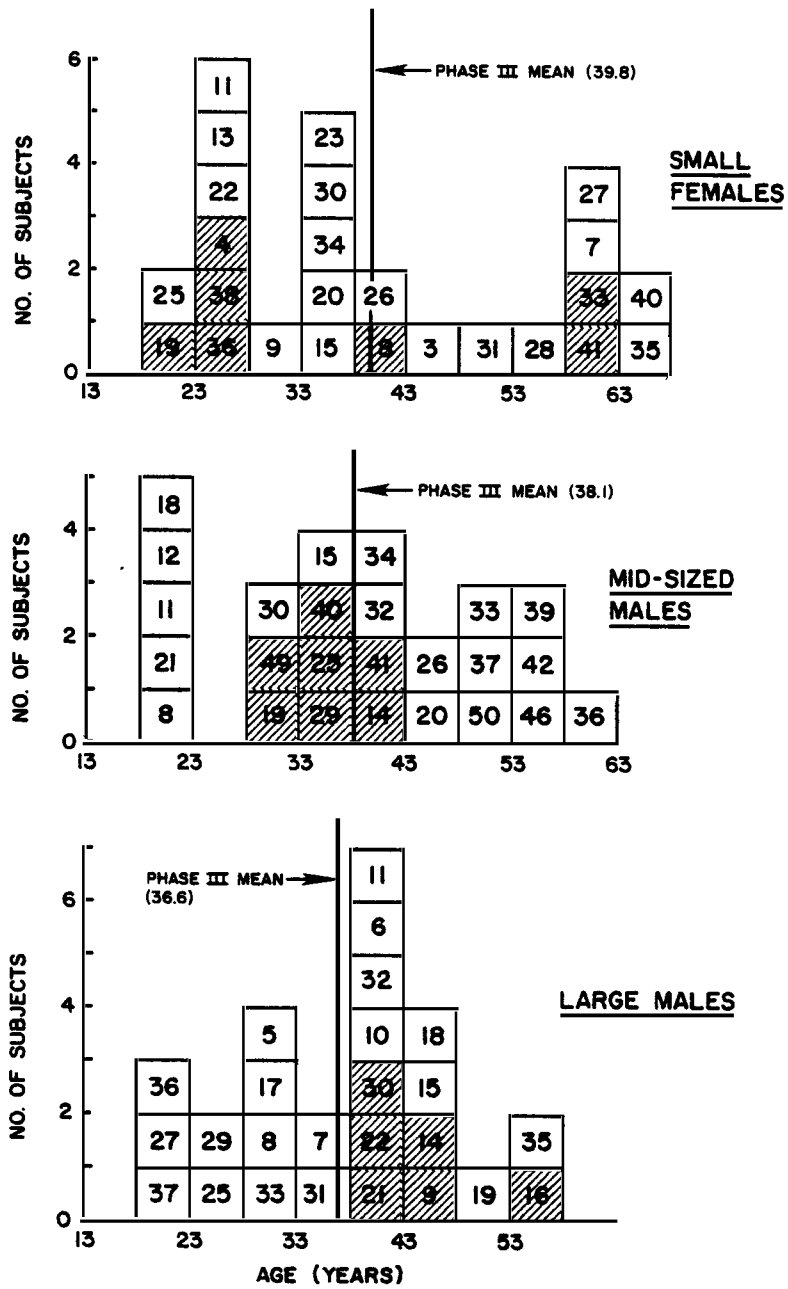


FIGURE D-1. Age distributions for Phase III subjects.

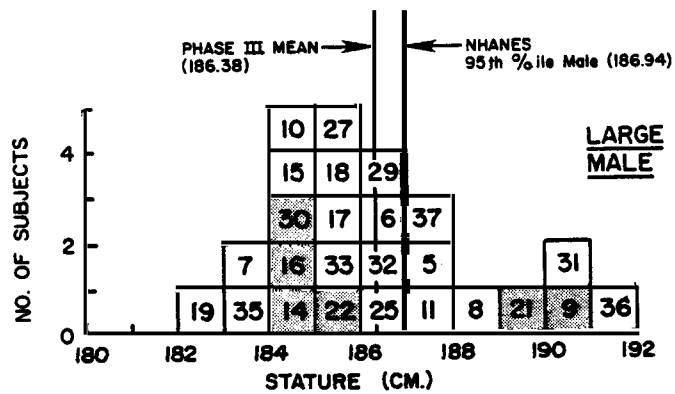
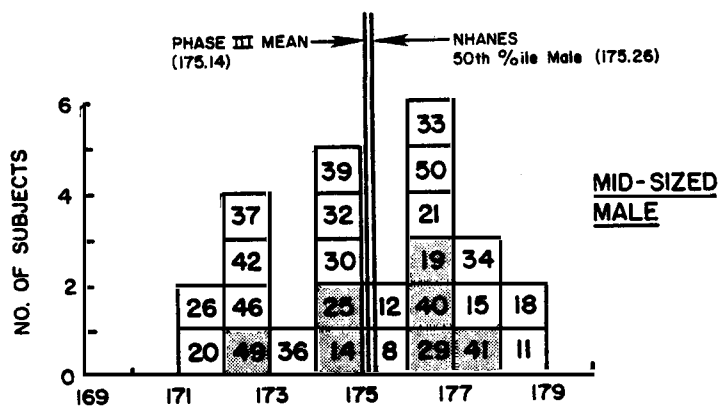
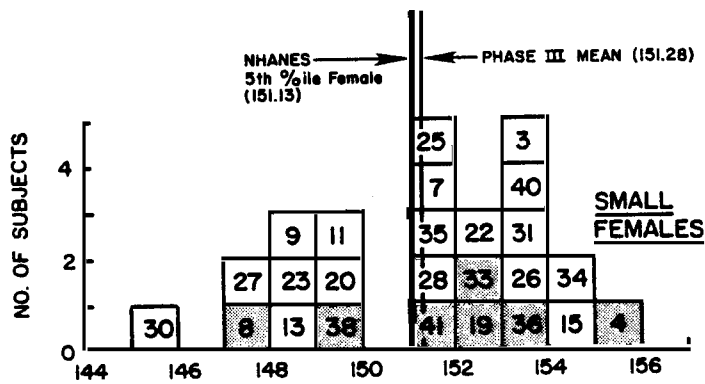


FIGURE D-2. Stature distributions for Phase III subjects.

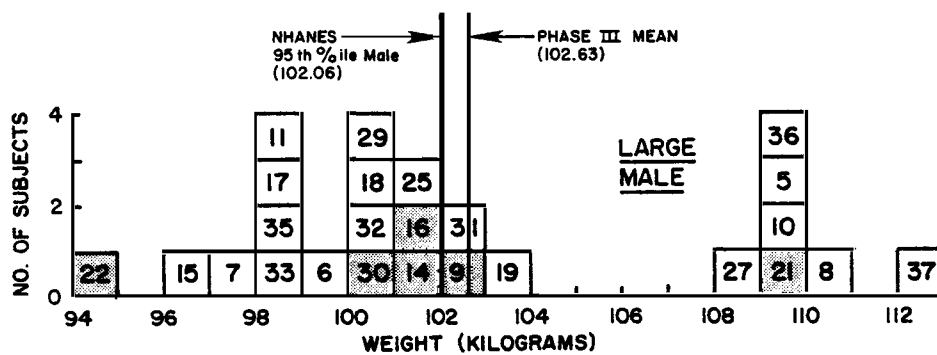
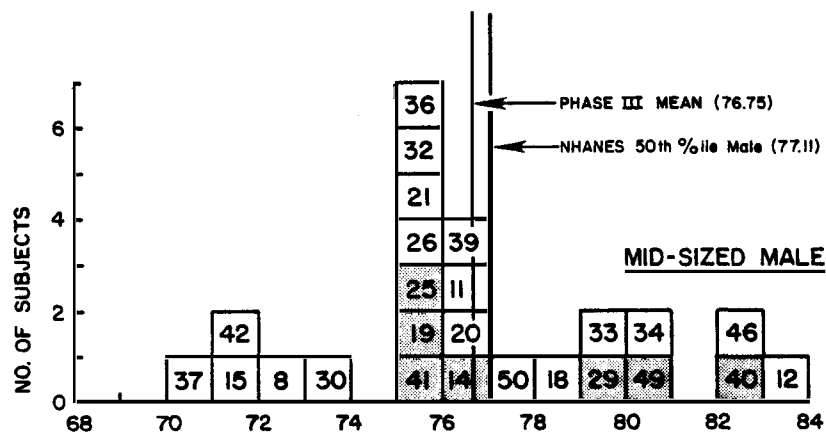
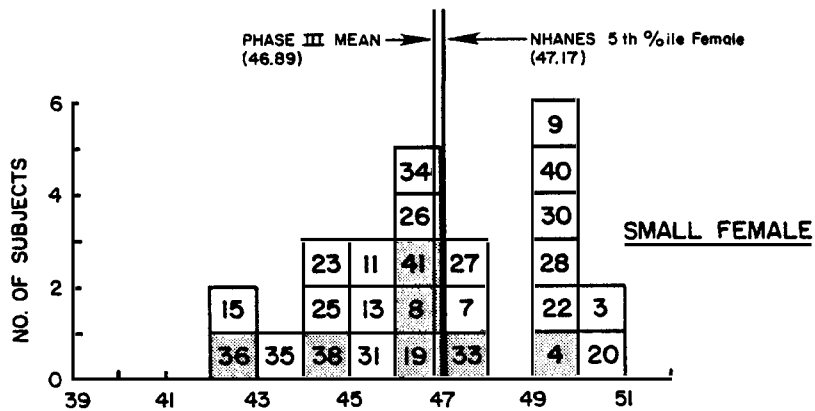


FIGURE D-3. Weight distributions for Phase III subjects.

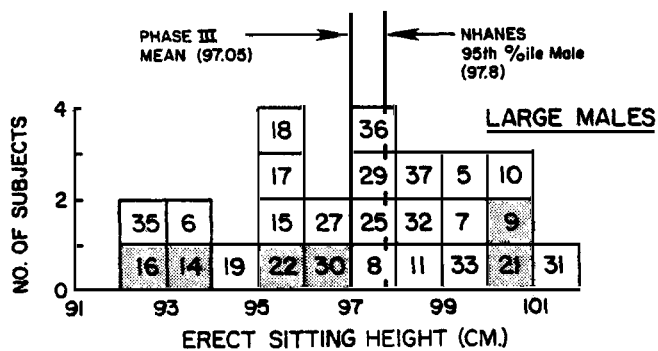
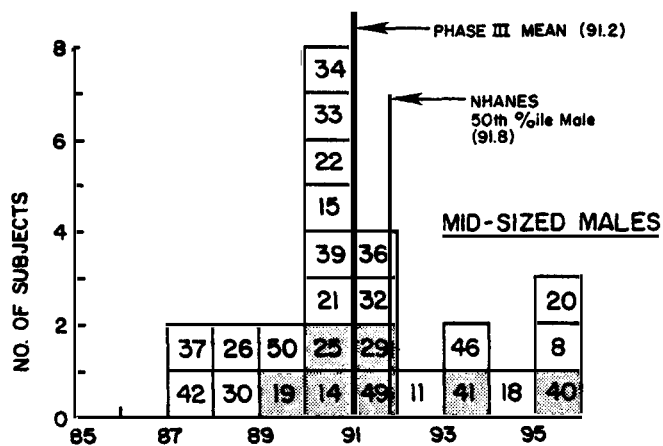
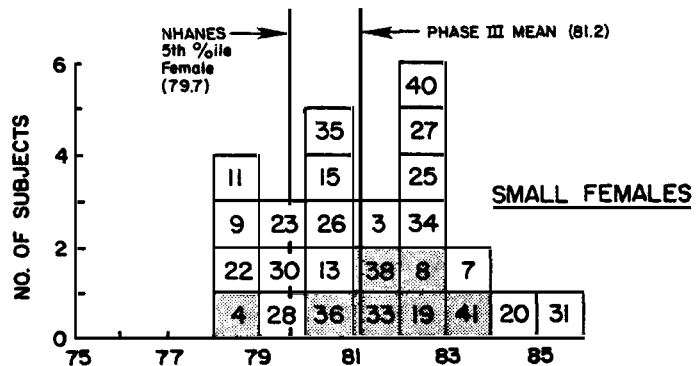


FIGURE D-4. Erect sitting height distributions for Phase III subjects.

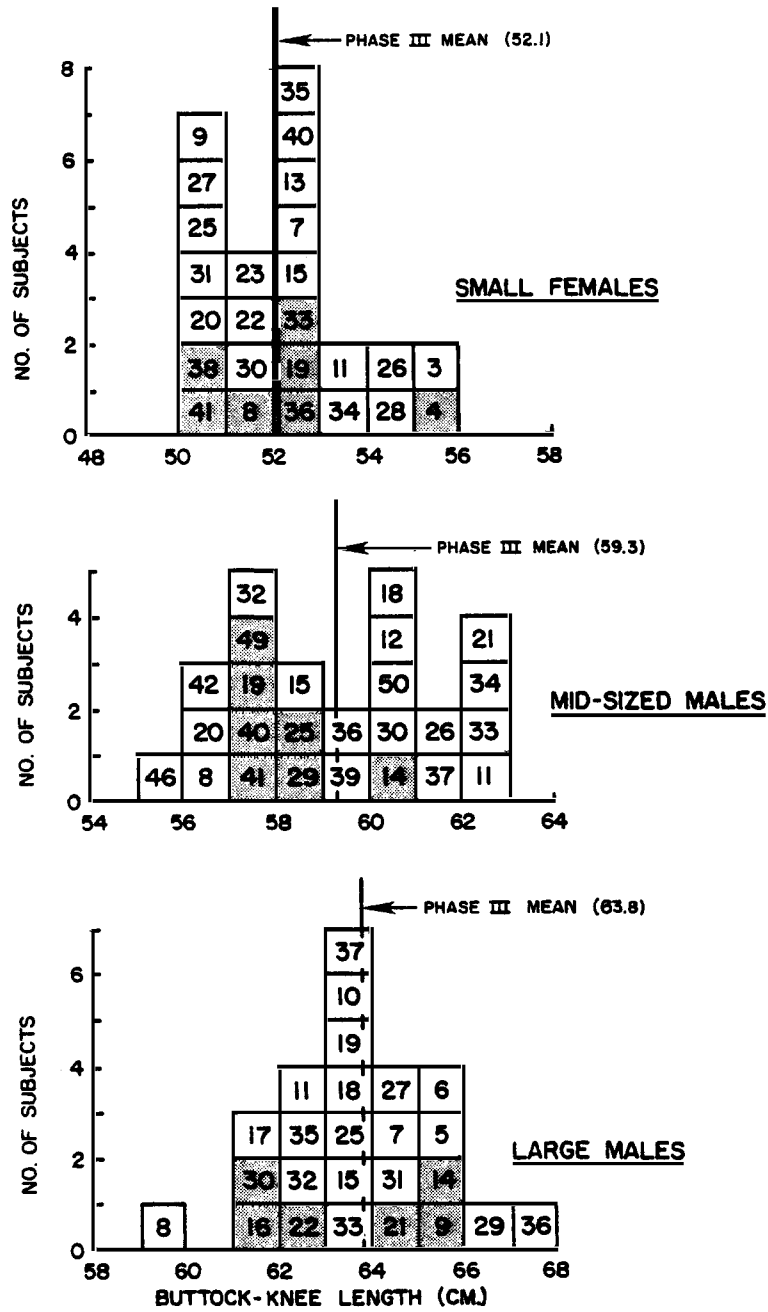


FIGURE D-5. Buttock-knee length distributions for Phase III subjects.

APPENDIX E

STANDARD ANTHROPOMETRY DEFINITIONS

This appendix contains an alphabetical listing and definitions of standard anthropometric measurements taken on subjects in the standing or erect sitting posture during a special measurement session prior to testing in the contoured hardseats. One of the purposes of the measurements was to provide linkage data for selection of skeletal material for the mid-sized male clay model armature. These measurements were also used in developing the anthropometric specifications and in sculpting parts of the clay models (e.g., the head). They also provide a basis for comparing the subject populations of this study with those of other studies.

STANDARD ANTHROPOMETRY DEFINITIONS

ACROMION-RADIALE LENGTH: The subject maintains an erect standing posture, feet slightly apart, head held erect. The left elbow is flexed at 90° and the forearm is held horizontally. Use an anthropometer to measure the distance from left acromion landmark to left radiale landmark. (Acromion landmark is a point on the surface of the skin obtained by palpating the most lateral margin of the acromial process of the scapula. Radiale landmark is a point on the surface of the skin obtained by palpating the most inferior-lateral margin of the proximal head of the radius.)

BIACROMIAL BREADTH: The subject maintains an erect standing posture, feet slightly apart, arms hanging at the sides, head held erect. Use an anthropometer held horizontally to measure the distance between left and right acromion landmarks. (Acromion landmark is a point on the surface of the skin obtained by palpating the most lateral margin of the acromial process of the scapula.)

BISPINOUS BREADTH: The subject maintains an erect standing posture, feet slightly apart, arms hanging at the sides, head held erect. Use an anthropometer to measure the distance between the left and right anterior-superior iliac spine landmarks. (Anterior-superior iliac spine landmark is a point on the surface of the skin obtained by palpating the anterior-superior spine on the iliac crest of the pelvis.)

BUTTOCK-KNEE LENGTH: The subject sits erect on a hard, flat surface, head held erect, arms resting in lap, feet together on a horizontal surface so that the knees are flexed at 90°. Use an anthropometer to measure the distance from the posterior aspect of the left buttock to the most anterior aspect of the left kneecap.

CALF CIRCUMFERENCE (maximum): The subject maintains an erect standing posture, feet slightly apart, arms hanging at the sides, head held erect. Use a steel tape to measure the maximum circumference of the left calf in a plane perpendicular to the long axis of the lower leg.

CERVICALE HEIGHT: The subject maintains an erect standing posture, feet slightly apart, arms hanging at the sides, head held erect. Use an anthropometer to measure the vertical distance from the reference surface to cervicale landmark. (Cervicale landmark is a point on the surface of the skin obtained by palpating the most posterior-superior margin of the spinous process of the seventh cervical vertebra.)

CHEST CIRCUMFERENCE (axilla): The subject maintains an erect standing posture, feet slightly apart, arms hanging at the sides, head held erect. Use a steel tape to measure the circumference of the chest at the level of the left and right axillary folds during mid-inhalation. The subject raises the arms slightly while the tape is positioned and then lowers them to the sides before the measurement is taken. (The axillary folds are formed at the junctures of the upper arms and torso.)

CHEST CIRCUMFERENCE (nipple): The subject maintains an erect standing posture, feet slightly apart, arms hanging at the sides, head held erect. Use a steel tape to measure the circumference of the chest in a horizontal plane at the level of the nipples during mid-inhalation. The subject raises the arms slightly while the tape is positioned and then lowers them to the sides before the measurement is taken.

CLAVICLE LENGTH: The subject maintains an erect standing posture, feet slightly apart, arms hanging at the sides, head held erect. Use an anthropometer to measure the distance from the left clavicle landmark to the left acromio-clavicular articulation landmark. (Clavicle landmark is a point on the surface of the skin obtained by palpating the most superior margin on the medial border of the clavicle at the articulation with the manubrium of the sternum. Acromio-clavicular articulation landmark is a point on the surface of the skin obtained by palpating the midpoint of articulation between the lateral margins of the clavicle and the acromial process of the scapula.)

ELBOW-HAND LENGTH: The subject maintains an erect standing posture, feet slightly apart, head held erect. The left elbow is flexed at 90°, the left forearm is held horizontal with the hand outstretched, fingers together, and thumb up. Use an anthropometer to measure the distance from the most posterior aspect of the elbow to the most distal point on the longest finger.

FOOT BREADTH: Subject maintains an erect standing posture, feet slightly apart, arms hanging at the sides, head held erect. Use an anthropometer to measure the maximum breadth of the left foot at the base of the toes.

FOOT LENGTH: The subject maintains an erect standing posture, feet slightly apart, arms hanging at the sides, head held erect. Use an anthropometer to measure the distance from the most posterior aspect of the left heel to the most distal point on the longest toe of the left foot.

FOREARM CIRCUMFERENCE (mid): The subject maintains an erect standing posture, feet slightly apart, arms hanging at the sides, head held erect. Use a steel tape to measure the circumference of the forearm midway between the elbow and the wrist in a plane perpendicular to the long axis of the forearm.

HAND BREADTH: The subject's left hand is extended on a flat surface with the palm up, fingers together. Use sliding calipers to measure the maximum breadth of the hand at the base of the fingers.

HAND LENGTH: The subject's left hand is extended on a flat surface with the palm up, fingers together. Use sliding calipers to measure the distance from the proximal edge of the navicular to the most distal point on the longest (usually middle) finger. (Navicular is the most proximal carpal on the thumb side of the wrist when the palm is up.)

HEAD CIRCUMFERENCE: The subject maintains an erect standing posture, feet slightly apart, arms hanging at the sides, head held erect. Use a steel tape to measure the maximum circumference of the head in a horizontal plane just superior to the brow ridges.

HEAD BREADTH: The subject maintains an erect standing posture, feet slightly apart, arms hanging at the sides, head held erect. Use an anthropometer to measure the maximum breadth of the head in the mid-coronal plane.

HEAD HEIGHT: The subject maintains an erect standing posture, feet slightly apart, arms hanging at the sides, head held erect. Use an anthropometer to measure the height of the head from the most inferior aspect of the chin to the most superior point on the top of the head in the midline.

HEAD LENGTH: The subject maintains an erect standing posture, feet slightly apart, arms hanging at the sides, head held erect. Use an anthropometer to measure the maximum length of the head from just above the brow ridges to the occiput (the occiput is the most posterior part of the head).

HIP CIRCUMFERENCE (maximum): The subject maintains an erect standing posture, feet slightly apart, arms hanging at the sides, head held erect. Use a steel tape to measure the maximum circumference of the hips in a horizontal plane.

RADIUS LENGTH: The subject maintains an erect standing posture, feet slightly apart, head held erect. The left elbow is flexed at 90° and the left forearm is held horizontally with the hand supinated (palm up). Use an anthropometer to measure the distance from radiale landmark to stylium landmark. (Radiale landmark is a point on the surface of the skin obtained by palpating the most inferior-lateral margin of the proximal head of the radius. Stylium landmark is a point on the surface of the skin obtained by palpating the most distal margin of the styloid process of the radius.)

SHOULDER BREADTH: The subject maintains an erect standing posture, feet slightly apart, arms hanging at the sides, head held erect. Use an anthropometer to measure the maximum breadth of the shoulders across the deltoid muscles.

SHOULDER CIRCUMFERENCE: The subject maintains an erect standing posture, feet slightly apart, arms hanging at the sides, head held erect. Use a steel tape to measure the maximum circumference of the shoulders in a horizontal plane at the level of the deltoid muscles during mid-inhalation.

SHOULDER-ELBOW LENGTH: The subject maintains an erect standing posture, feet slightly apart, head held erect. With the left elbow at 90° and the left forearm held horizontally, use an anthropometer to measure the distance from the acromio-clavicular articulation landmark to the bottom of the elbow. (Acromio-clavicular articulation landmark is a point on the surface of the skin obtained by palpating the midpoint of articulation between the lateral margins of the clavicle and acromial process of the scapula.)

SITTING HEIGHT (erect): The subject sits erect on a hard, flat surface, head held erect, arms resting in lap, feet together on a horizontal surface so that the knees are flexed at 90°. Use an anthropometer to measure the vertical distance from the sitting surface to the most superior point on the top of the head in the mid-sagittal plane.

SKINFOLD, POSTERIOR MID-CALF: The subject maintains an erect standing posture, feet slightly apart, arms hanging at the sides, head held erect. Locate the fold of skin on the back of the calf midway between the ankle and knee by lifting the tissue in the direction of the long axis of the lower leg (a tight skin adhesion is most commonly found here). A reading is made with the Lange calipers within three seconds after application of the calipers. The average is taken of several readings.

SKINFOLD, SUBSCAPULAR: The subject maintains an erect standing posture, feet slightly apart, arms hanging at the sides, head held erect. Locate the fold of skin just below the inferior angle of the scapula by lifting the tissue in the direction of the ribs, so that the skinfold is angled upward medially and downward laterally at about 45° from the horizontal. A reading is made with the Lange calipers within three seconds after application of the calipers. The average is taken of several readings.

SKINFOLD, SUPRAILIAC: The subject maintains an erect standing posture, feet slightly apart, arms hanging at the sides, head held erect. Locate the fold of skin just superior to the lateral aspect of the iliac crest by lifting the tissue in a direction across the top of the crest and angled slightly upward medially. A reading is made with the Lange calipers within three seconds after application of the calipers. The average is taken of several readings.

SKINFOLD, TRICEPS: The subject maintains an erect standing posture, feet slightly apart, arms hanging at the sides, head held erect. Locate the fold of skin on the back of the upper arm at the triceps muscle midway between the shoulder and elbow by lifting the tissue in the direction of the long axis of the arm. A reading is made with a Lange caliper within three seconds after application of the calipers. The average is taken of several readings.

STATURE: The subject maintains an erect standing posture, feet together, arms hanging at sides, head held erect. Use an anthropometer to measure the vertical distance from the reference surface to the most superior point on the top of the head in the mid-sagittal plane.

SUPRASTERNALE-CERVICALE DISTANCE: The subject maintains an erect standing posture, feet slightly apart, arms hanging at the sides, head held erect. Use an anthropometer to measure the distance from suprasternale landmark to cervicale landmark. (Suprasternale landmark is a point on the surface of the skin obtained by palpating the most superior margin of the jugular notch of the manubrium in the midline of the sternum. Cervicale landmark is a point on the surface of the skin obtained by palpating the most posterior-superior margin of the spinous process of the seventh cervical vertebra.)

THIGH CIRCUMFERENCE (mid): The subject maintains an erect standing posture, feet slightly apart, arms hanging at the sides, head held erect. Use a steel tape to measure the circumference of the left thigh at mid-shaft in a plane perpendicular to the long axis of the upper leg.

TIBIALE HEIGHT: The subject maintains an erect standing posture, feet slightly apart, arms hanging at the sides, head held erect. Use an anthropometer to measure the vertical distance from the reference surface to the left tibiale landmark. (Tibiale landmark is a point on the surface of the skin obtained by palpating the most superior margin of the medial condyle of the tibia.)

TIBIA LENGTH: The subject maintains an erect standing posture, feet slightly apart, arms hanging at the sides, head held erect. Use an anthropometer to measure the distance from the left tibiale landmark to the left sphyrion landmark. (Tibiale landmark is a point on the surface of the skin obtained by palpating the most superior margin of the medial condyle of the tibia. Sphyrion landmark is a point on the surface of the skin obtained by palpating the most prominent aspect of the medial malleolus of the tibia.)

TROCHANTERION HEIGHT: The subject maintains an erect standing posture, feet slightly apart, arms hanging at the sides, head held erect. Use an anthropometer to measure the vertical distance from the reference surface to the left trochanterion landmark. (Trochanterion landmark is a point on the surface of the skin obtained by palpating the most lateral margin of the greater trochanter of the femur.)

TROCHANTERION-TO-LATERAL FEMORAL CONDYLE: The subject maintains an erect standing posture, feet slightly apart, arms hanging at the sides, head held erect. Use an anthropometer to measure the distance from the left trochanterion landmark to the lateral femoral condyle landmark. (Lateral femoral condyle landmark is a point on the surface of the skin obtained by palpating the most prominent aspect of the lateral condyle of the femur; Trochanterion landmark is a point on the surface of the skin obtained by palpating the most lateral margin of the greater trochanter of the femur.)

UPPER ARM CIRCUMFERENCE (biceps): The subject maintains an erect standing posture, feet slightly apart, arms hanging at the sides, head held erect. Use a steel tape to measure the circumference of the left upper arm in a plane perpendicular to the long axis of the upper arm at the maximum diameter of the relaxed biceps muscle.

WAIST CIRCUMFERENCE (umbilicus): The subject maintains an erect standing posture, feet together, arms hanging at the sides, head held erect. Use a steel tape to measure the circumference of the waist in a horizontal plane at the level of the umbilicus landmark during mid-inhalation. (Umbilicus landmark is a point on the surface of the skin at the center of the navel or "belly button.")

WEIGHT (unclothed): Use a standard medical scale to measure weight to the nearest one-half pound.

APPENDIX F

PHOTOGRAPHS OF PHASE III MEASUREMENTS IN THE CONTOURED HARDSEATS

Figures F-1 and F-2 provide an overview of the final measurement session in which subjects were measured in the contoured hardseats. The sequence flows from top to bottom and left to right. After placement of surface markers (not shown), subjects were measured for pre-photo anthropometry, i.e., measurements that should correlate with target coordinates. The subjects then went through a sequence of four positions for collecting stereophotogrammetric data describing the X_L , Y_L , and Z_L coordinates of surface landmarks. This was followed by post-photo seated anthropometry and measurement and recording of surface contours.

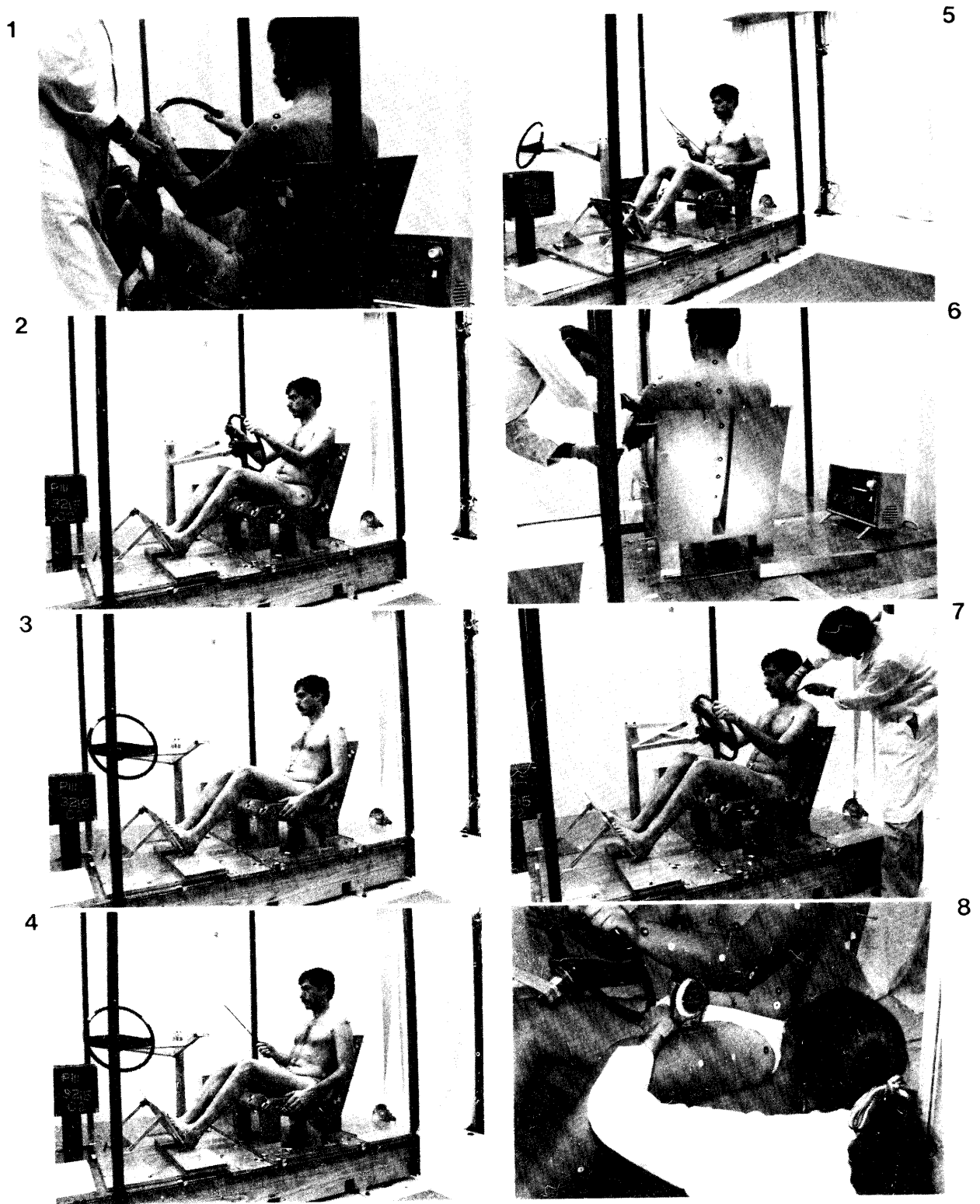
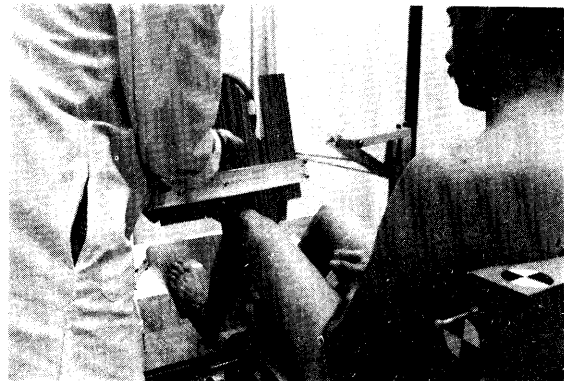


FIGURE F-1. Phase III measurements on a mid-sized male: (1) pre-photo anthropometry; (2-5) photogrammetry positions; (6-8) post-photo measurements.

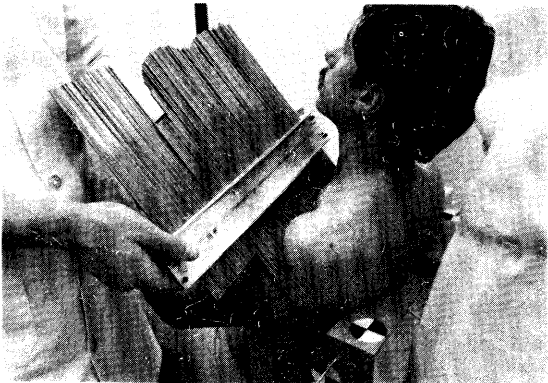
9



11



10



12



13

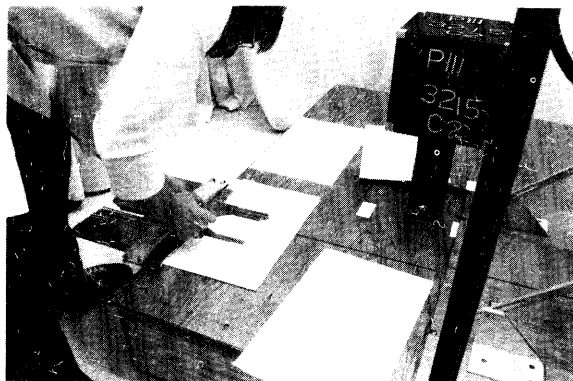


FIGURE F-1 (Continued). Phase III measurements on a mid-sized male: (9-13) body contours.

APPENDIX G

SURFACE LANDMARK DEFINITIONS

This appendix contains a dictionary of skin surface landmarks which were targeted for photogrammetry on subjects seated in the contoured hardseats during Phase III testing. The majority of these landmarks designate palpations of skeletal prominences in order to define the seated posture and body segment coordinate systems for development of the anthropometric specification packages. There are also a number of landmarks that do not relate to palpation of the skeletal structures. Landmarks such as "arm upper landmark" and "calf landmark" are skin surface points where breadths, depths, and circumference measures were taken, while landmarks such as "scye anterior landmark" and "thigh-abdominal-junction landmark" indicate points of particular interest in defining and sculpting the clay models.

Two surface landmarks warrant particular mention. These are the "anterior-superior iliac spine (ASIS) landmark" and the "symphysis landmark" palpated on the pelvis. Because of the large amount of tissue that lies over these skeletal points (especially at symphysis) in the seated position and the importance of defining the orientation of the pelvis in this study, these landmarks were obtained by compressing the tissue with a 1/4-inch-diameter rod. The landmarks determined in this way, while on the surface of the skin, are not on the surface of natural body contours in the seated position. By using this technique, however, it was not only possible to get closer to the desired skeletal points, but also to use photogrammetry to determine the coordinates of these points which are otherwise difficult or impossible to "see."

While all the landmarks defined in this appendix were targeted for photogrammetry with the subject seated in the contoured hardseat, many were also used in taking anthropometric measurements. For seated anthropometry taken in the contoured hardseats (Appendix H), the targeted landmarks were used directly, although in some cases where a spherical marker was used, the target was removed just prior to taking the measurement. For standard anthropometric measures (Appendix E)

taken in a separate session with the subject in either a standing or erect seated position, the same landmark definitions apply, but may imply different surface points due to differences in body orientation and soft tissue distribution.

For the definitions that follow, Figures G-1 and G-2 illustrate the meaning of the various orientation terms (e.g., lateral, superior, distal) in the standing and seated postures, respectively. Appendix K provides a listing of the surface landmark points by body region along with the landmark reference numbers used on the engineering drawings.

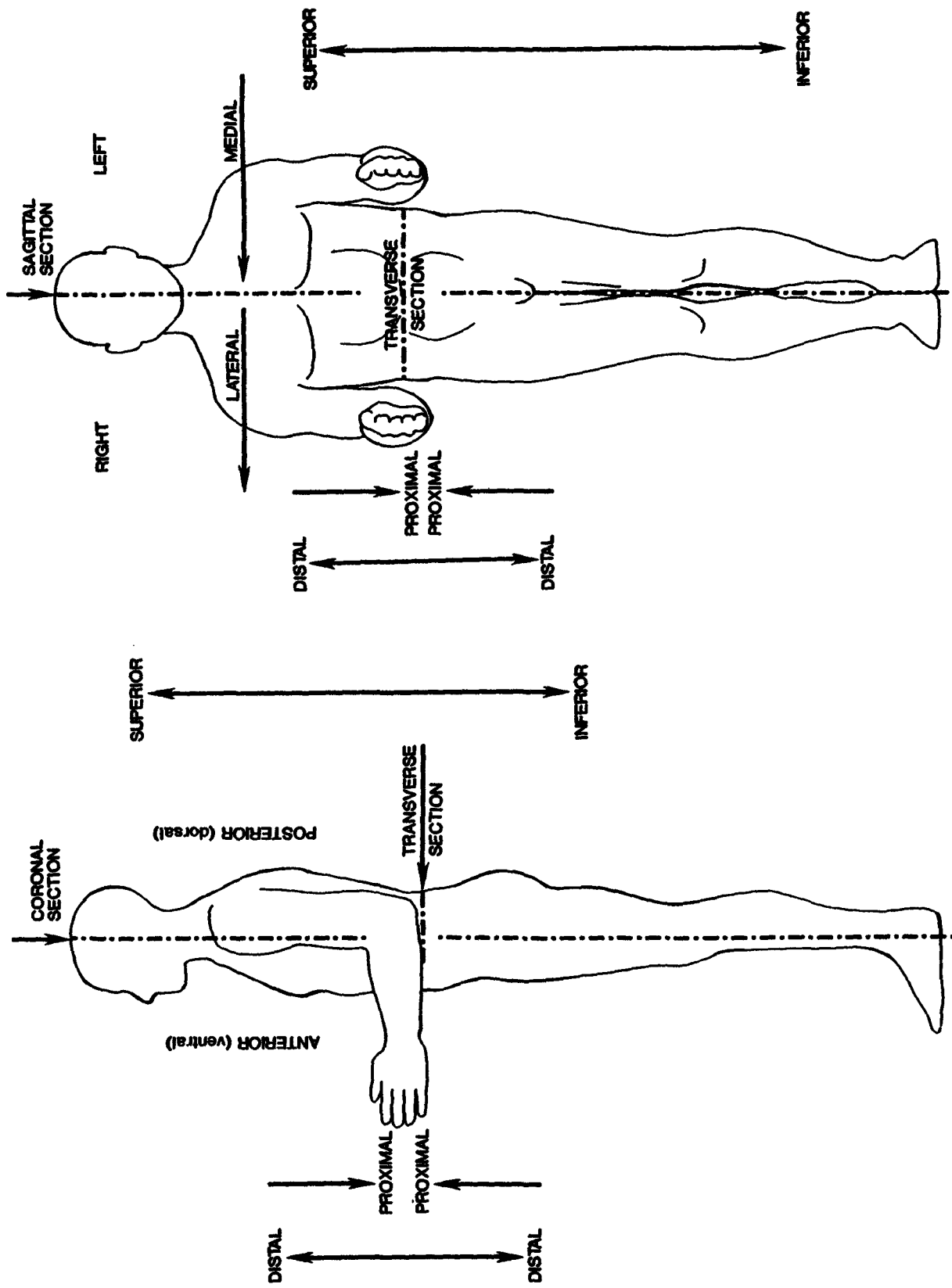


FIGURE G-1. Body orientation terms for surface landmark definitions in the standing posture.

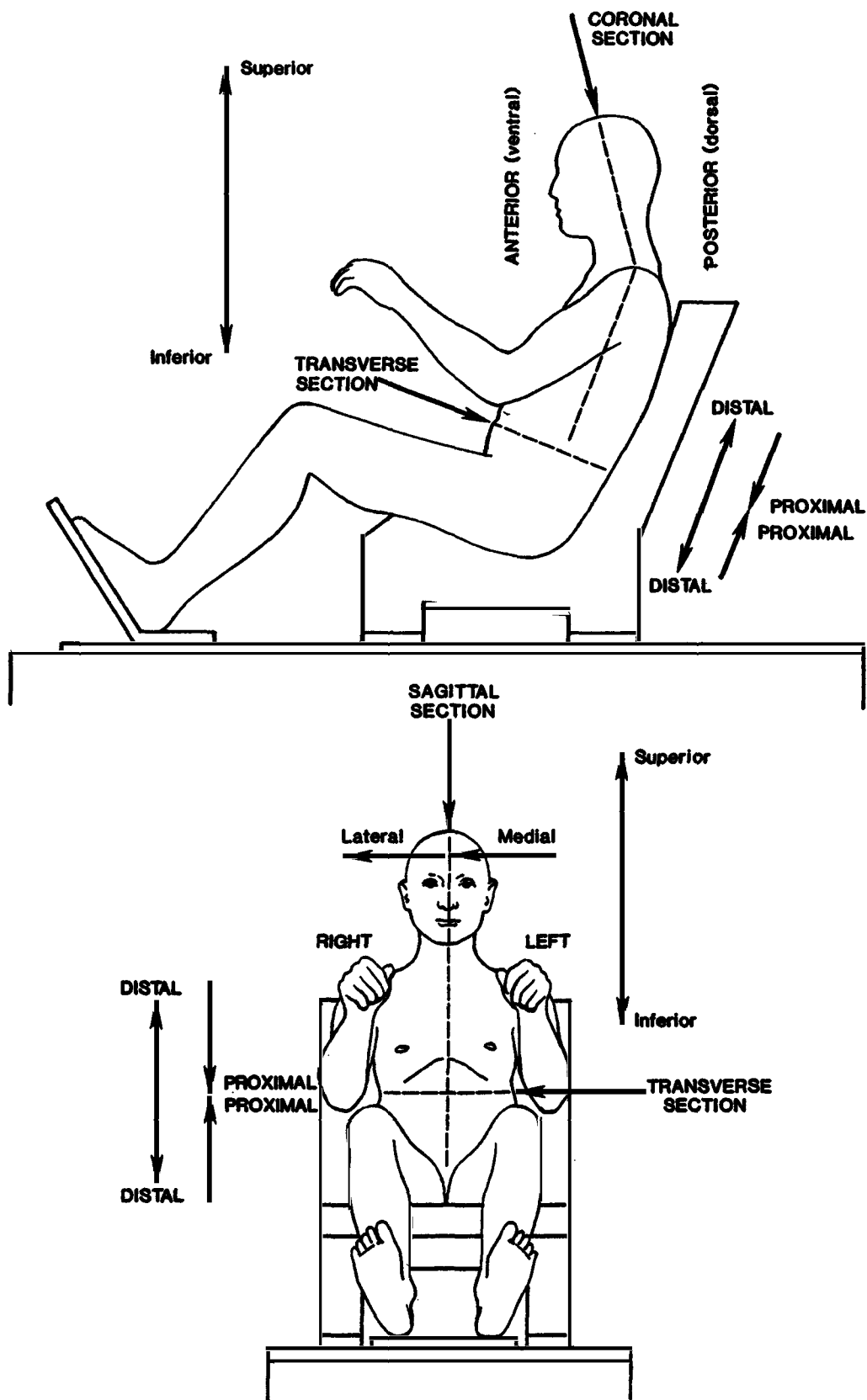


FIGURE G-2. Body orientation terms for surface landmark definitions in the seated posture.

SURFACE LANDMARK DEFINITIONS

ACROMIO-CLAVICULAR ARTICULATION LANDMARK: A point on the surface of the skin obtained by palpating the midpoint of articulation between the lateral margins of the clavicle and acromial process of the scapula.

ACROMION LANDMARK: A point on the surface of the skin obtained by palpating the most lateral margin of the acromial process of the scapula.

ANKLE LANDMARK: A point marked on the lateral surface of the lower leg at the estimated minimum circumference (above the condyles).

ANTERIOR-SUPERIOR ILIAC SPINE LANDMARK (ASIS): A point on the surface of the skin obtained by palpating the most anterior-superior spine on the iliac crest of the pelvis. (The photogrammetry landmark is measured by compressing the skin and underlying soft tissue with a one-quarter-inch diameter rod.)

ARM UPPER LANDMARK: A point marked on the lateral surface of the upper arm at the estimated maximum circumference.

BIMAMMARY MIDLINE LANDMARK: A point on the surface of the skin in the anterior midline of the torso bisecting a line connecting the left and right nipples.

CALF LANDMARK: A point marked on the lateral surface of the calf at the estimated maximum circumference.

CERVICALE LANDMARK: A point on the surface of the skin obtained by palpating the most posterior-superior margin of the spinous process of the seventh cervical vertebra.

CLAVICALE LANDMARK: A point on the surface of the skin obtained by palpating the most superior margin on the medial border of the clavicle at the articulation with the manubrium of the sternum.

DIGIT II (TOE) LANDMARK: A point on the surface of the most distal aspect of the second toe.

FOREARM LOWER LANDMARK: A point marked on the lateral surface of the forearm between the estimated maximum circumference and the wrist.

FOREARM UPPER LANDMARK: A point marked on the lateral surface of the forearm at the estimated maximum circumference.

GLABELLA LANDMARK: A point on the surface of the skin obtained by palpating the most forward projection of the forehead in the midline at the level of the brow ridges.

GNATHION LANDMARK: A point on the surface of the skin obtained by palpating the most anterior-inferior margin of the mandible in the midline (i.e., the lower edge of the chin).

GONION LANDMARK: A point on the surface of the skin obtained by palpating the most inferior, posterior, and lateral point on the external angle of the mandible, i.e., the angle of the lower jaw bone.

GREATER TUBERCLE HUMERUS LANDMARK: A point on the surface of the skin obtained by palpating the anterior margin of the greater tubercle on the proximal end of the humerus (located by palpation while raising the arm anteriorly).

ILIOCRISTALE LANDMARK: A point on the surface of the skin obtained by palpating the most superior margin on the iliac crest of the pelvis.

INFRAORBITALE LANDMARK: A point on the surface of the skin obtained by palpating the most inferior margin of the eye orbit (eye socket).

LATERAL FEMORAL CONDYLE LANDMARK: A point on the surface of the skin obtained by palpating the most prominent aspect of the lateral condyle of the femur.

LATERAL HUMERAL EPICONDYLE LANDMARK: A point on the surface of the skin obtained by palpating the most prominent aspect of the lateral epicondyle of the humerus.

LATERAL MALLEOLUS LANDMARK: A point on the surface of the skin obtained by palpating the most prominent aspect of the lateral malleolus of the fibula (outside of ankle).

L2 LANDMARK: A point on the surface of the skin obtained by palpating the most posterior-superior margin of the spinous process of the second lumbar vertebra.

L5 LANDMARK: A point on the surface of the skin obtained by palpating the most posterior-superior margin of the spinous process of the fifth lumbar vertebra.

MAXIMUM ABDOMINAL PROTRUSION LANDMARK: A point on the surface of the skin in the anterior midline at the level of the maximum protrusion of the abdomen.

MEDIAL FEMORAL EPICONDYLE LANDMARK: A point on the surface of the skin obtained by palpating the most prominent aspect of the medial epicondyle of the femur.

MEDIAL HUMERAL EPICONDYLE LANDMARK: A point on the surface of the skin obtained by palpating the most prominent aspect of the medial epicondyle of the humerus.

MESOSTERNALE LANDMARK: A point on the surface of the skin obtained by palpating in the midline of the sternum between the most superior margin of the jugular notch and the most inferior point on the manubrium.

METATARSAL/PHALANGEAL I LANDMARK: A point on the surface of the skin obtained by palpating the midpoint of articulation between the head of metatarsus I and the first phalange of the hallux (big toe) on the medial side of the foot.

METATARSAL/PHALANGEAL V LANDMARK: A point on the surface of the skin obtained by palpating the midpoint of articulation between the head of the metatarsus V and the first phalange of the fifth toe on the lateral side of the foot.

NECK LOWER LANDMARK: A point marked on the lowest margin of the lateral surface of the neck.

NECK MID LANDMARK: A point marked at the estimated midpoint of the lateral surface of the neck.

NIPPLE LANDMARK: A point on the surface of the skin at the center of the pigmented projection on the anterior surface of the mammary gland.

OLECRANON LANDMARK: A point on the surface of the skin obtained by palpating the most posterior-inferior margin of the olecranon process of the ulna (i.e., approximately the lowest point on the elbow).

PATELLA LANDMARK: A point on the surface of the skin obtained by palpating the most anterior-inferior aspect of the patella.

RADIALE LANDMARK: A point on the surface of the skin obtained by palpating the most inferior lateral margin of the proximal head of the radius.

SCAPULA INFERIOR MARGIN LANDMARK: A point on the surface of the skin obtained by palpating the most medial border of the inferior margin of the scapula.

SCAPULA SUPERIOR MARGIN LANDMARK: A point on the surface of the skin obtained by palpating the most medial border of the superior margin of the scapula.

SCYE ANTERIOR LANDMARK: A point on the surface of the skin at the anterior-superior margin of the skin furrow formed by the juncture of the upper arm and torso (i.e., the anterior axillary fold).

SCYE POSTERIOR LANDMARK: A point on the surface of the skin at the posterior-superior margin of the skin furrow formed by the juncture of the upper arm and torso (i.e., the posterior axillary fold).

SPHYRION LANDMARK: A point on the surface of the skin obtained by palpating the most prominent aspect of the medial malleolus of the tibia (inside of ankle).

STYLION LANDMARK: A point on the surface of the skin obtained by palpating the most distal margin of the styloid process of the radius (thumb side of wrist).

SUBSTERNALE LANDMARK: A point on the surface of the skin obtained by palpating the most inferior margin of the manubrium in the midline of the sternum.

SUPRASTERNALE LANDMARK: A point on the surface of the skin obtained by palpating the most superior margin of the jugular notch of the manubrium in the midline of the sternum.

SYMPHYSION LANDMARK (PUBIC SYMPHYSIS): A point on the surface of the skin obtained by palpating the most anterior-superior margin of the pubic symphysis. (The photogrammetry landmark is measured by compressing the skin and underlying soft tissue with a one-quarter-inch diameter rod.)

TENTH RIB ANTERIOR MIDLINE LANDMARK: A point on the surface of the skin obtained by projecting the most inferior margin palpable on the tenth rib to the anterior midline in a plane estimated to be perpendicular to the long axis of the torso.

TENTH RIB LANDMARK: A point on the surface of the skin obtained by palpating the most inferior margin of the tenth rib.

TENTH RIB MID-SPINE LANDMARK: A point on the surface of the skin obtained by horizontally projecting the most inferior margin palpable on the tenth rib to its corresponding point in the midline of the vertebral column.

THIGH-ABDOMINAL JUNCTION LANDMARK: A point on the surface of the skin at the crease formed by the juncture of the thigh and abdomen at approximately the midline of the thigh.

THIGH MID LANDMARK: A point marked on the lateral surface of the thigh approximately halfway between the estimated maximum circumference and the knee.

THIGH UPPER LANDMARK: A point marked on the lateral surface of the thigh at the estimated maximum circumference.

TIBIALE LANDMARK: A point on the surface of the skin obtained by palpating the most superior margin of the medial condyle of the tibia.

TRAGION LANDMARK: A point on the surface of the skin obtained by palpating the most anterior margin of the cartilaginous notch just superior to the tragus of the ear (located at the upper edge of the external auditory meatus).

TROCHANTERION LANDMARK: A point on the surface of the skin obtained by palpating the most lateral margin of the greater trochanter of the femur.

T4 LANDMARK: A point on the surface of the skin obtained by palpating the most posterior-superior margin of the spinous process of the fourth thoracic vertebra.

T8 LANDMARK: A point on the surface of the skin obtained by palpating the most posterior-superior margin of the spinous process of the eighth thoracic vertebra.

T12 LANDMARK: A point on the surface of the skin obtained by palpating the most posterior-superior margin of the spinous process of the twelfth thoracic vertebra.

ULNAR STYLOID LANDMARK: A point on the surface of the skin obtained by palpating the most distal margin of the styloid process of the ulna (little finger side of wrist).

UMBILICUS LANDMARK: A point on the surface of the skin at the center of the navel or "belly button."

APPENDIX H

ANTHROPOMETRIC MEASUREMENTS IN CONTOURED HARDSEATS

This appendix contains measurement descriptions, illustrations, and summary statistics for each of the anthropometric measurements taken in the contoured hardseats during the final (Phase III) measurement session. Each measurement is presented on a separate page and the measurements are grouped and ordered by body region beginning with the head and ending with the legs and feet. Table H.1 shows the list of measurements in their order of occurrence along with the page number of the measurement description.

The measurement description is an attempt to describe how the measurement was obtained and the illustration is provided as an aid to visualizing the description. Descriptions of height measurements refer to a "reference surface" from which the vertical distance is taken. At the time of data collection, this surface was the top of the 3/4-inch plywood board to which the contoured hardseats were bolted (see Figure C-2). The height distances presented in the summary statistics are relative to the surfaces of the final seat assembly platforms which are approximately 19 mm (3/4 inch) higher (in Z direction) than the reference surface of the measurement buck.

Most of the measurement descriptions begin with a sentence describing the subject as sitting in a "relaxed driving posture." This is an abbreviated terminology referring to the "standardized" posture discussed previously in Section 3 of the report. Measurement descriptions involving surface landmarks used in photogrammetry and defined in Appendix G include redefinition of these landmarks at the end of the description.

Because of the complex three-dimensional orientation of different parts of the body in the seated posture, it is difficult to accurately illustrate all body measurements with two-dimensional drawings. The illustrations are therefore presented as an aid to understanding the written measurement description and are not intended to accurately describe the measurements on their own. In some instances, tips of arrows indicating the distance measured have purposely been truncated at

a body outline or drawn over a body outline in order to indicate that the measurement is taken between surfaces oblique to the plane of the illustration. Also, in some cases, dimension lines are drawn at angles in an attempt to capture the oblique nature of the measurement to the body segment. Illustrations used include three horizontal views of the seated subject from the front, left side, and rear, as well as one oblique view from the upper front. As appropriate for each definition, the subject is illustrated with hands on the steering wheel (not included) or hands dropped to the sides of the chair.

The table of summary statistics at the bottom of each page presents the sample size (N), minimum, maximum, mean, and coefficient of variation of the measurement for the three dummy sizes. Numbers in parenthesis in these tables give the values in English units. The coefficient of variation (CV%) is an indication of the spread or variance of the measurement relative to the mean and is computed by dividing the standard deviation by the mean and multiplying by 100 to get a percentage value ($CV\% = S.D./\bar{x} \times 100$).

TABLE H.1
INDEX TO HARDSEAT MEASUREMENTS

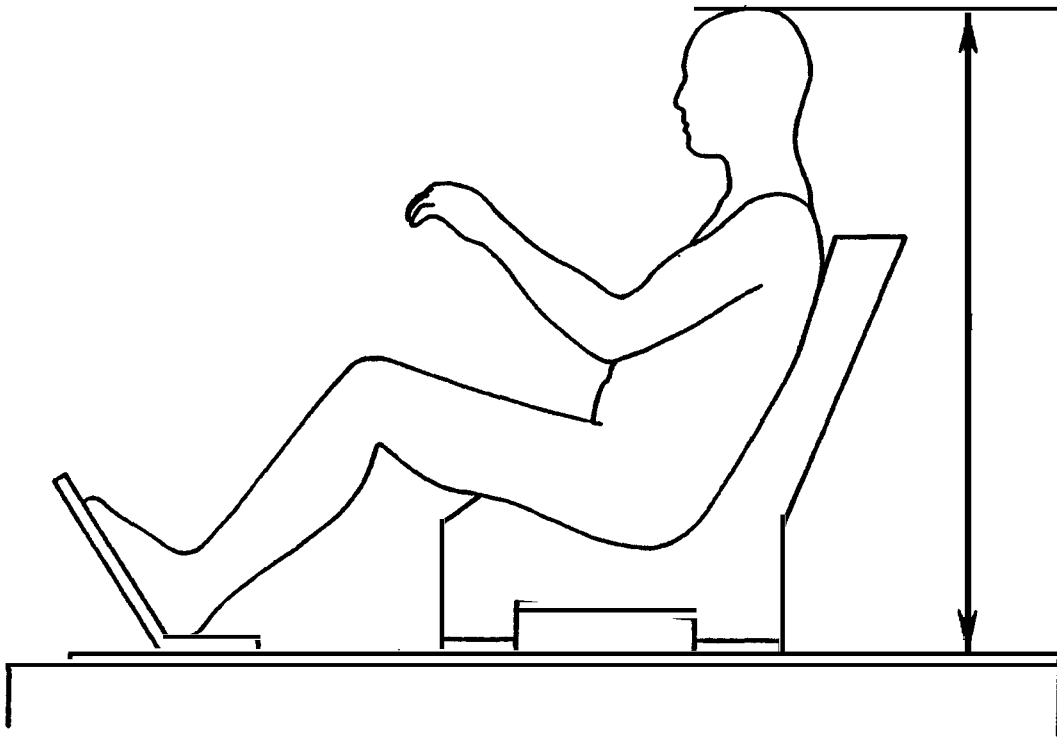
Measurement	Page No.
Sitting Height	H - 5
Cervicale Height	H - 6
Chin Height	H - 7
Neck Length (anterior)	H - 8
Neck Breadth (mid)	H - 9
Neck Depth (mid)	H - 10
Neck Circumference (mid)	H - 11
Neck Breadth (lower)	H - 12
Neck Depth (lower)	H - 13
Neck Circumference (lower)	H - 14
Shoulder Height (mid)	H - 15
Acromion Height	H - 16
Clavicle-to-Acromio-Clavicular Articulation	H - 17
Shoulder Breadth	H - 18
Shoulder Circumference	H - 19
Biacromial Breadth	H - 20
Torso Depth (upper)	H - 21
Shoulder Depth (scye)	H - 22
Axillary Depth	H - 23
Arm Angle (upper)	H - 24
Arm Angle (lower)	H - 25
Right-Left Medial Humeral Epicondyle	H - 26
Right-Left Stylium	H - 27
Arm Circumference (scye)	H - 28
Arm Breadth (upper)	H - 29
Arm Depth (upper)	H - 30
Arm Circumference (upper)	H - 31
Arm Breadth (above elbow)	H - 32
Arm Depth (above elbow)	H - 33
Arm Circumference (above elbow)	H - 34
Olecranon Height	H - 35
Elbow Breadth	H - 36
Elbow Depth	H - 37
Elbow Circumference	H - 38
Forearm Breadth (upper)	H - 39
Forearm Depth (upper)	H - 40
Forearm Circumference (upper)	H - 41
Forearm Circumference (lower)	H - 42
Wrist Breadth (condyles)	H - 43
Wrist Depth (condyles)	H - 44
Wrist Circumference (condyles)	H - 45
Chest Height (nipple)	H - 46
Chest Height (posterior scye)	H - 47
Chest Breadth (axilla)	H - 48
Chest Circumference (axilla)	H - 49

TABLE H.1
HARDSEAT MEASUREMENT INDEX (Continued)

Measurement	Page No.
Chest Breadth (nipple)	H - 50
Chest Circumference (nipple)	H - 51
Chest Circumference (tenth rib)	H - 52
Waist Breadth (umbilicus)	H - 53
Waist Depth (umbilicus)	H - 54
Waist Circumference (umbilicus)	H - 55
Abdominal Breadth (maximum)	H - 56
Abdominal Depth (maximum)	H - 57
Abdominal Circumference (maximum)	H - 58
Iliocristale Height	H - 59
Thigh-Abdominal Junction Height	H - 60
Anterior-Superior Iliac Spine Height	H - 61
Trochanterion Height	H - 62
Hip Breadth (maximum)	H - 63
Bitrochanter Breadth	H - 64
Leg Angle (upper)	H - 65
Leg Angle (lower)	H - 66
Right-Left Medial Femoral Epicondyle	H - 67
Right-Left Sphyrion	H - 68
Trochanter-To-Lateral Femoral Condyle	H - 69
Thigh Breadth (upper)	H - 70
Thigh Circumference (upper)	H - 71
Thigh Breadth (mid)	H - 72
Thigh Circumference (mid)	H - 73
Knee Height	H - 74
Knee Breadth	H - 75
Knee Depth (popliteal)	H - 76
Knee Circumference	H - 77
Calf Breadth	H - 78
Calf Depth	H - 79
Calf Circumference	H - 80
Ankle Breadth (minimum)	H - 81
Ankle Depth (minimum)	H - 82
Ankle Circumference (minimum)	H - 83
Ankle Breadth (condyles)	H - 84
Ankle Depth (condyles)	H - 85
Ankle Circumference (condyles)	H - 86

SITTING HEIGHT

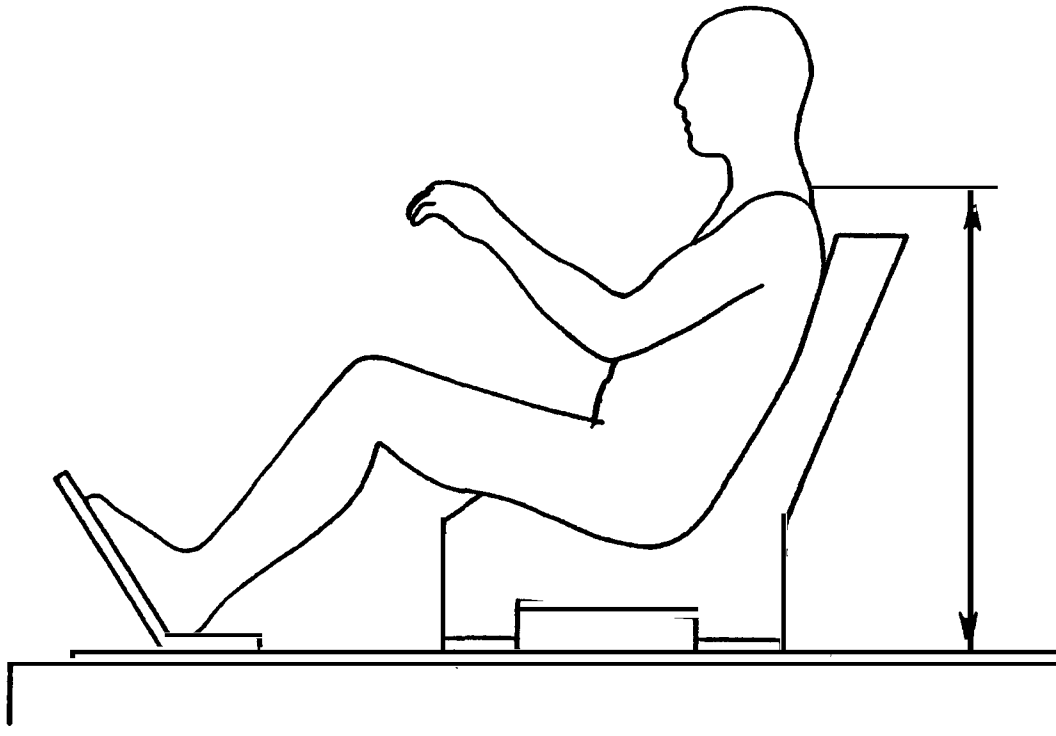
The subject sits in the contoured hardseat, feet placed firmly on the toeboard, hands on the steering wheel at the 10 o'clock and 2 o'clock positions, the head and body in a relaxed driving posture. Use an anthropometer to measure the vertical distance from the reference surface to the most superior point on the head.



	N	Minimum	Maximum	Mean	Std Dev	CV %
Small Female	25	90.5 (35.6)	95.5 (37.6)	93.3 (36.7)	1.34 (cm) (0.53) (in)	1.44
Mid-Sized Male	25	97.0 (38.2)	104.4 (41.1)	100.3 (39.5)	1.85 (cm) (0.73) (in)	1.85
Large Male	25	99.3 (39.1)	105.4 (41.5)	102.9 (40.5)	1.77 (cm) (0.70) (in)	1.72

CERVICALE HEIGHT

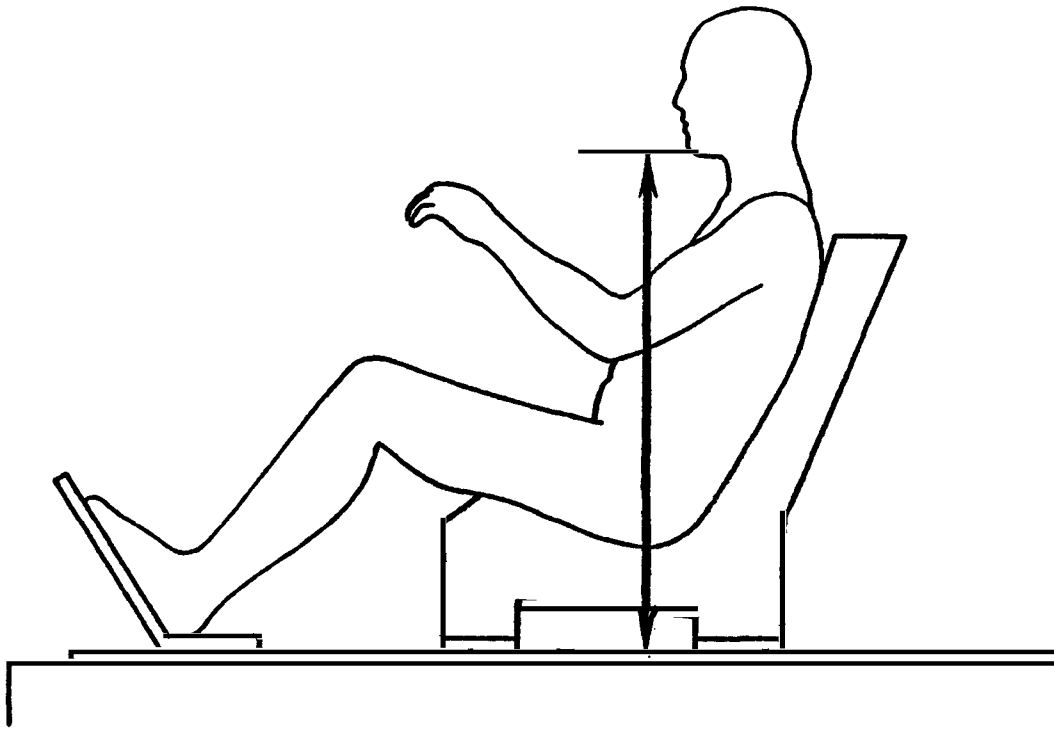
The subject sits in the contoured hardseat, feet placed firmly on the toeboard, hands on the steering wheel at the 10 o'clock and 2 o'clock positions, the head and body in a relaxed driving posture. Use an anthropometer to measure the vertical distance from the reference surface to the cervicale landmark. (The cervicale landmark is a point on the surface of the skin obtained by palpating the most posterior-superior margin of the spinous process of the seventh cervical vertebra.)



	N	Minimum	Maximum	Mean	Std Dev	CV %
Small Female	25	68.9 (27.1)	73.1 (28.8)	71.2 (28.0)	1.16 (cm) (0.46) (in)	1.63
Mid-Sized Male	25	72.1 (28.4)	78.5 (30.9)	75.3 (29.6)	1.75 (cm) (0.69) (in)	2.32
Large Male	25	75.3 (29.6)	81.1 (31.9)	78.2 (30.8)	1.70 (cm) (0.67) (in)	2.18

CHIN HEIGHT

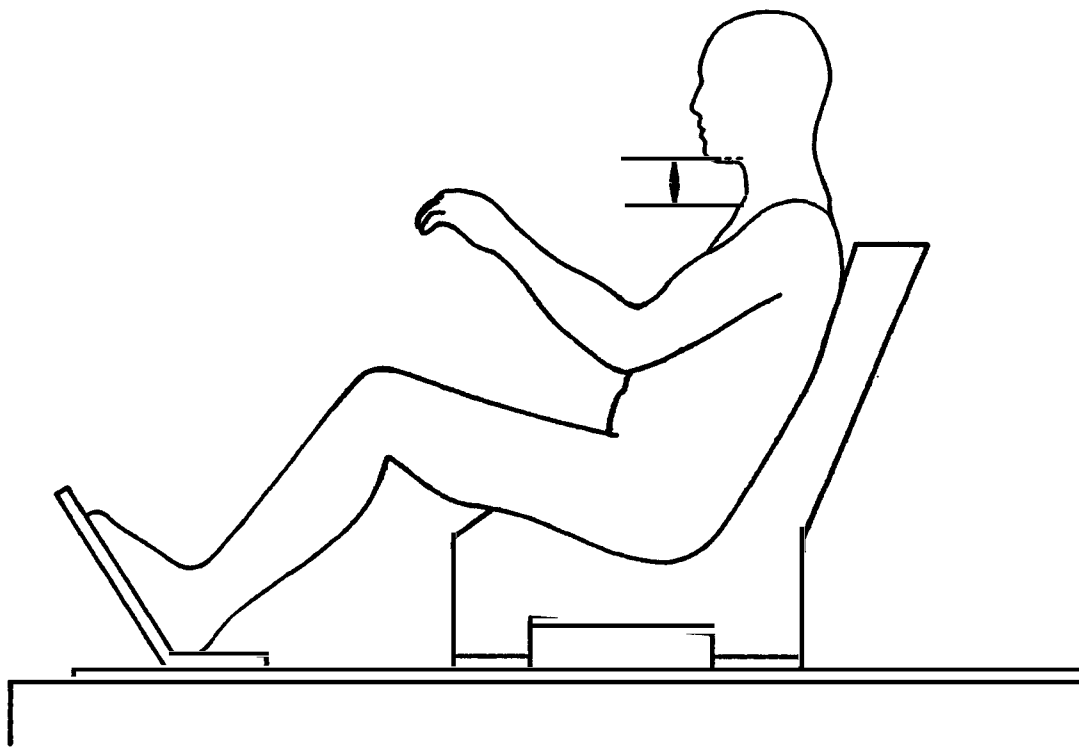
The subject sits in the contoured hardseat, feet placed firmly on the toeboard, hands on the steering wheel at the 10 o'clock and 2 o'clock positions, the head and body in a relaxed driving posture. Use an anthropometer to measure the vertical distance from the reference surface to the gnathion landmark. (The gnathion landmark is a point on the surface of the skin obtained by palpating the most anterior-inferior margin of the mandible in the midline, i.e., the lower edge of the chin).



	N	Minimum	Maximum	Mean	Std Dev	CV %
Small Female	25	70.5 (27.8)	76.3 (30.0)	73.2 (28.8)	1.59 (cm) (0.63) (in)	2.17
Mid-Sized Male	25	73.7 (29.0)	81.8 (32.2)	77.4 (30.5)	2.30 (cm) (0.90) (in)	2.96
Large Male	25	77.3 (30.4)	84.1 (33.1)	80.6 (31.7)	1.88 (cm) (0.74) (in)	2.33

NECK LENGTH (anterior)

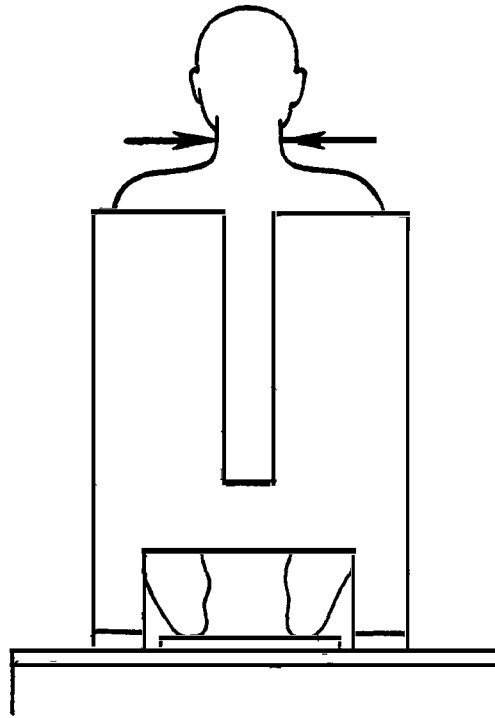
The subject sits in the contoured hardseat, feet placed firmly on the toeboard, hands on the steering wheel at the 10 o'clock and 2 o'clock positions, the head and body in a relaxed driving posture. Use an anthropometer, with blades reversed, to measure the length of the neck in the anterior midline from the suprasternale landmark to the head-neck juncture located by compressing the tissue under the chin with the anthropometer blade. Add two centimeters to the measured value to correct for the reversed blades. (The suprasternale landmark is a point on the surface of the skin obtained by palpating the most superior margin of the jugular notch of the manubrium in the midline of the sternum.)



	N	Minimum	Maximum	Mean	Std Dev	CV %
Small Female	25	5.8 (2.3)	10.6 (4.2)	8.1 (3.2)	1.24 (cm) (0.49) (in)	15.36
Mid-Sized Male	25	5.8 (2.3)	10.7 (4.2)	8.5 (3.3)	1.46 (cm) (0.58) (in)	17.25
Large Male	25	7.4 (2.9)	11.7 (4.6)	9.8 (3.9)	1.14 (cm) (0.45) (in)	11.64

NECK BREADTH (mid)

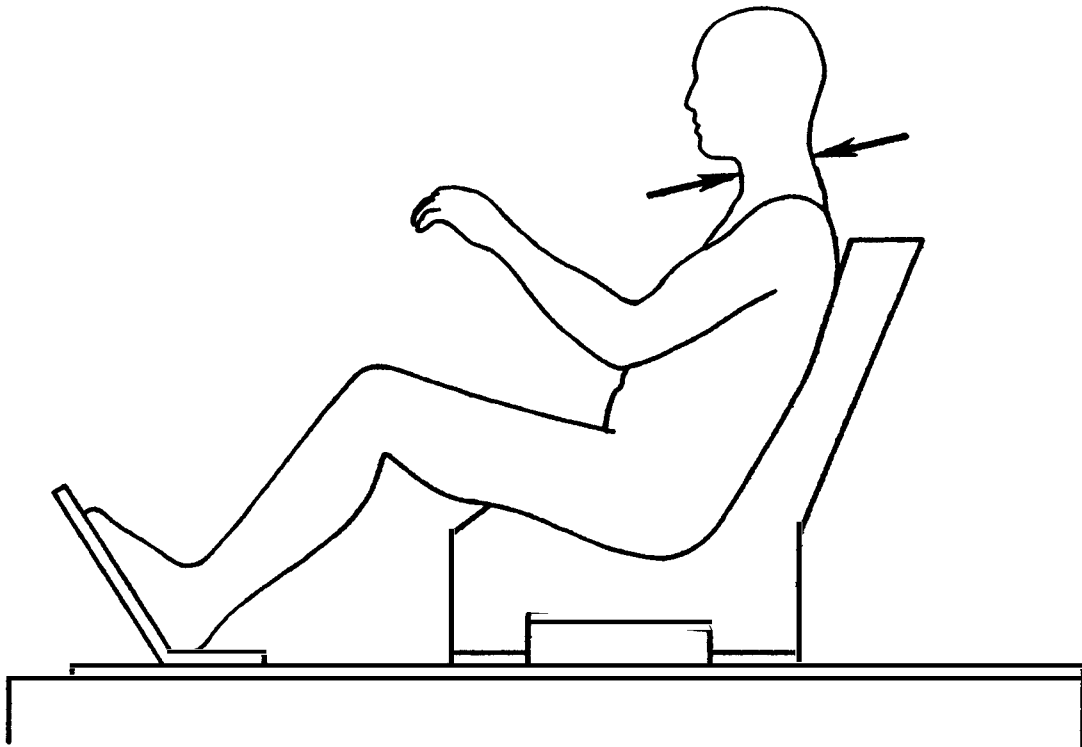
The subject sits in the contoured hardseat, feet placed firmly on the toeboard, hands on the steering wheel at the 10 o'clock and 2 o'clock positions, the head and body in a relaxed driving posture. Use an anthropometer held horizontally to measure the breadth of the neck at the level of the neck mid landmark. (The neck mid landmark is a point marked at the estimated midpoint of the lateral surface of the neck.)



	N	Minimum	Maximum	Mean	Std Dev	CV %
Small Female	25	8.1 (3.2)	11.0 (4.3)	9.1 (3.6)	0.58 (cm) (0.23) (in)	6.36
Mid-Sized Male	25	10.4 (4.1)	12.9 (5.1)	11.4 (4.5)	0.62 (cm) (0.24) (in)	5.50
Large Male	25	11.5 (4.5)	14.1 (5.6)	12.6 (5.0)	0.78 (cm) (0.31) (in)	6.17

NECK DEPTH (mid)

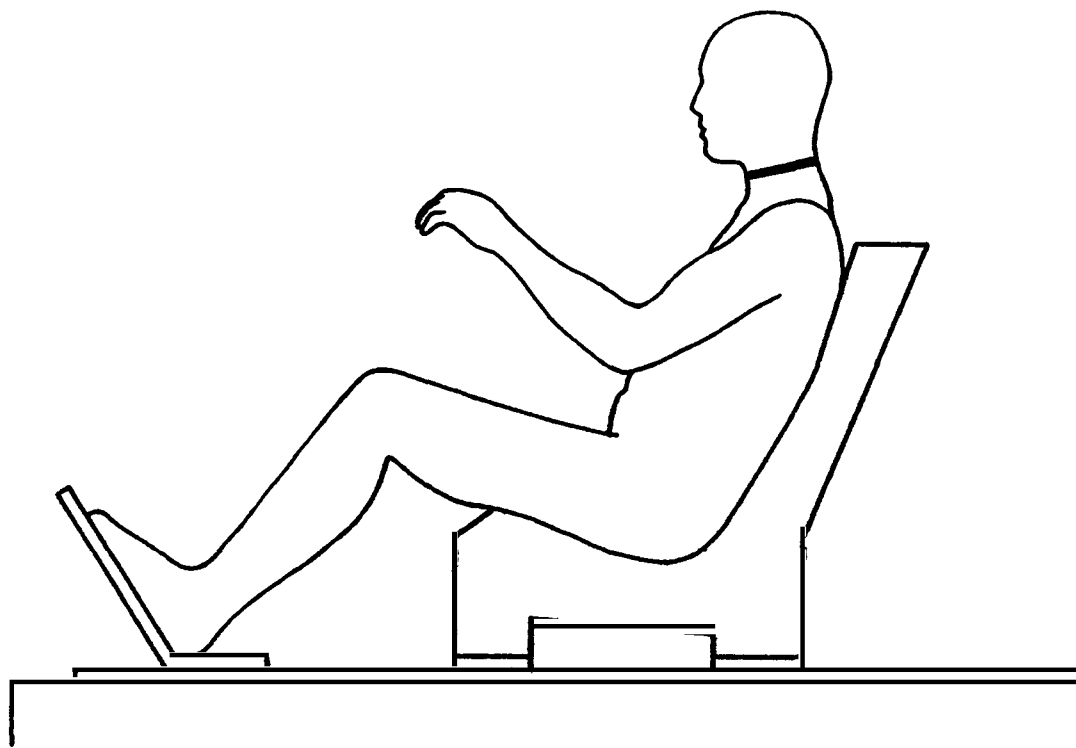
The subject sits in the contoured hardseat, feet placed firmly on the toeboard, hands on the steering wheel at the 10 o'clock and 2 o'clock positions, the head and body in a relaxed driving posture. Use an anthropometer to measure the depth of the neck perpendicular to the long axis of the neck at the level of the neck mid landmark. (The neck mid landmark is a point marked at the estimated midpoint of the lateral surface of the neck.)



	N	Minimum	Maximum	Mean	Std Dev	CV %
Small Female	24	8.1 (3.2)	9.7 (3.8)	9.0 (3.5)	0.48 (cm) (0.19) (in)	5.39
Mid-Sized Male	25	10.4 (4.1)	12.9 (5.1)	11.5 (4.5)	0.65 (cm) (0.26) (in)	5.69
Large Male	25	11.6 (4.6)	13.7 (5.4)	12.6 (5.0)	0.64 (cm) (0.25) (in)	5.05

NECK CIRCUMFERENCE (mid)

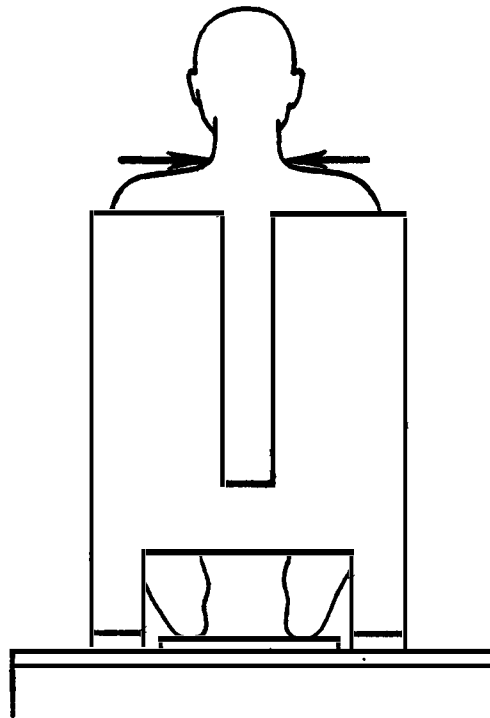
The subject sits in the contoured hardseat, feet placed firmly on the toeboard, hands on the steering wheel at the 10 o'clock and 2 o'clock positions, the head and body in a relaxed driving posture. Use a steel tape to measure the circumference of the neck in a plane perpendicular to the long axis of the neck at the level of the neck mid landmark. (The neck mid landmark is a point marked at the estimated midpoint of the lateral surface of the neck.)



	N	Minimum	Maximum	Mean	Std Dev	CV %
Small Female	25	27.9 (11.0)	34.8 (13.7)	30.4 (12.0)	1.54 (cm) (0.61) (in)	5.06
Mid-Sized Male	25	35.8 (14.1)	41.6 (16.4)	38.3 (15.1)	1.45 (cm) (0.57) (in)	3.77
Large Male	25	37.8 (14.9)	45.1 (17.8)	42.1 (16.6)	1.95 (cm) (0.77) (in)	4.63

NECK BREADTH (lower)

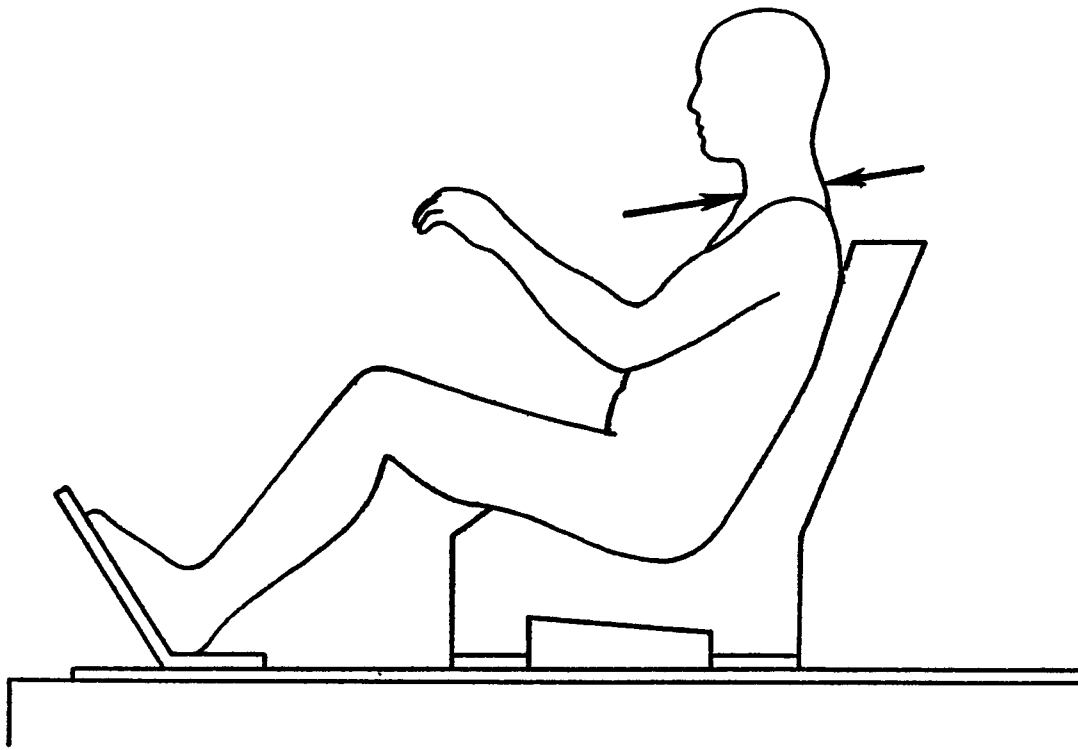
The subject sits in the contoured hardseat placed firmly on the toeboard, hands on the steering wheel at the 10 o'clock and 2 o'clock positions, the head and body in a relaxed driving posture. Use an anthropometer held horizontally to measure the breadth of the neck at the level of the neck lower landmark. (The neck lower landmark is a point marked on the lowest margin of the lateral surface of the neck.)



	N	Minimum	Maximum	Mean	Std Dev	CV %
Small Female	25	8.1 (3.2)	14.2 (5.6)	10.4 (4.1)	1.18 (cm) (0.47) (in)	11.33
Mid-Sized Male	25	11.1 (4.4)	13.6 (5.4)	12.2 (4.8)	0.67 (cm) (0.26) (in)	5.56
Large Male	25	12.0 (4.7)	15.0 (5.9)	13.6 (5.4)	0.82 (cm) (0.32) (in)	6.00

NECK DEPTH (lower)

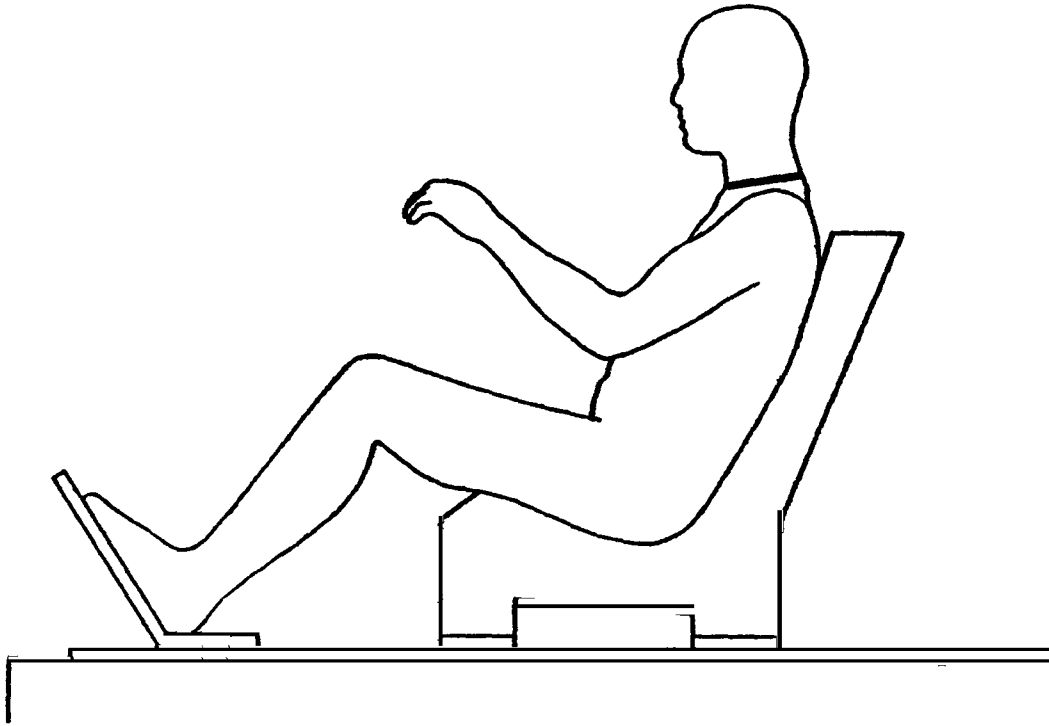
The subject sits in the contoured hardseat, feet placed firmly on the toeboard, hands on the steering wheel at the 10 o'clock and 2 o'clock positions, the head and body in a relaxed driving posture. Use an anthropometer to measure the depth of the neck perpendicular to the long axis of the neck at the level of the neck lower landmark. (The neck lower landmark is a point marked on the lowest margin on the lateral surface of the neck.)



	N	Minimum	Maximum	Mean	Std Dev	CV %
Small Female	25	7.9 (3.1)	10.0 (3.9)	9.3 (3.7)	0.53 (cm) (0.21) (in)	5.72
Mid-Sized Male	25	10.6 (4.2)	12.7 (5.0)	11.5 (4.5)	0.58 (cm) (0.23) (in)	5.04
Large Male	25	11.3 (4.4)	14.5 (5.7)	13.1 (5.1)	0.78 (cm) (0.31) (in)	5.95

NECK CIRCUMFERENCE (lower)

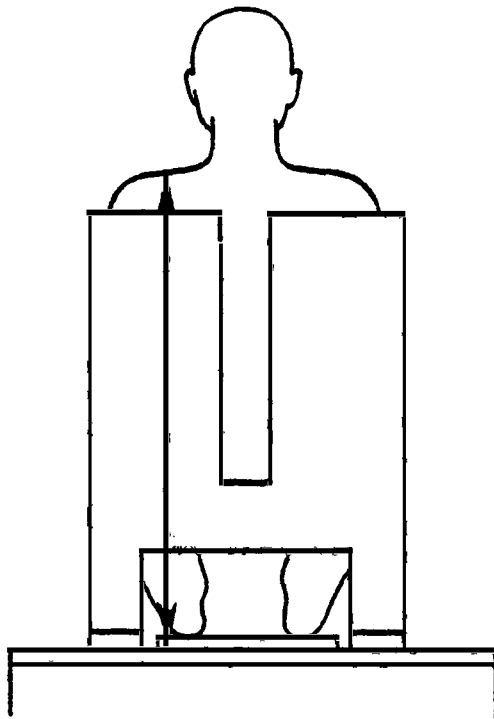
The subject sits in the contoured hardseat, feet placed firmly on the toeboard, hands on the steering wheel at the 10 o'clock and 2 o'clock positions, the head and body in a relaxed driving posture. Use a steel tape to measure the circumference of the neck in a plane perpendicular to the long axis of the neck at the level of the neck lower landmark. (The neck lower landmark is a point marked on the lowest margin of the lateral surface of the neck.)



	N	Minimum	Maximum	Mean	Std Dev	CV %
Small Female	25	29.4 (11.6)	36.4 (14.3)	32.2 (12.7)	1.64 (cm) (0.65) (in)	5.10
Mid-Sized Male	25	37.0 (14.6)	42.0 (16.5)	39.3 (15.5)	1.26 (cm) (0.50) (in)	3.21
Large Male	25	38.6 (15.2)	47.5 (18.7)	43.3 (17.1)	2.33 (cm) (0.92) (in)	5.38

SHOULDER HEIGHT (mid)

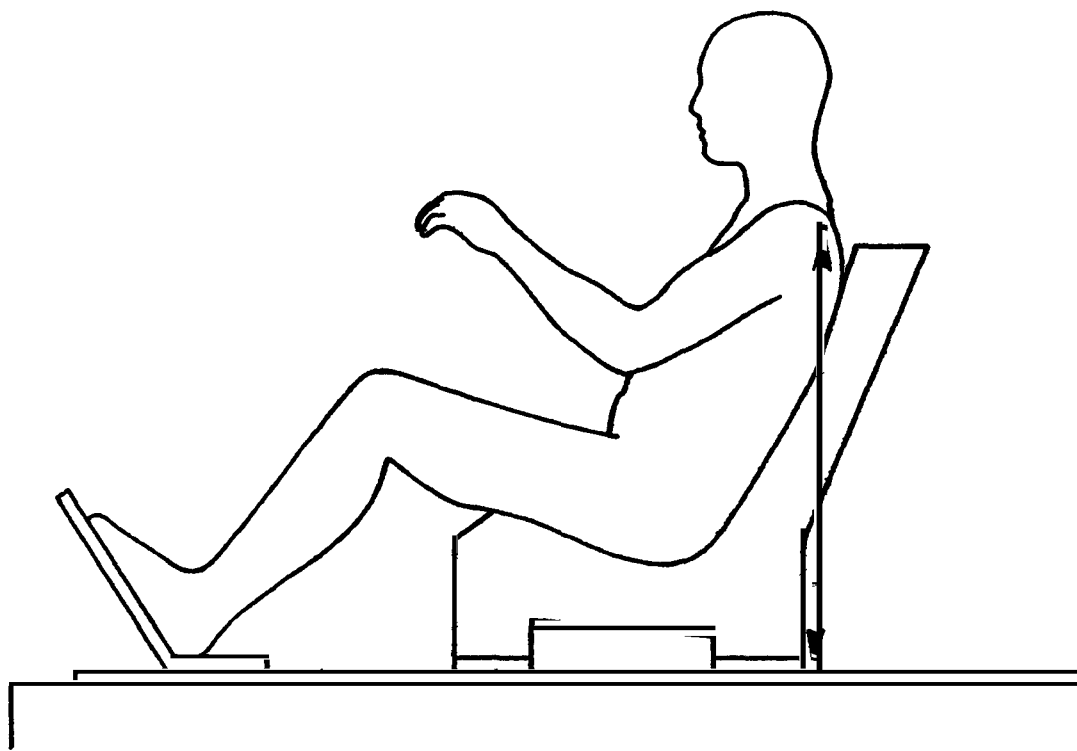
The subject sits in the contoured hardseat, feet placed firmly on the toeboard, hands on the steering wheel at the 10 o'clock and 2 o'clock positions, the head and body in a relaxed driving posture. Use an anthropometer to measure the vertical distance from the reference surface to the most superior aspect of the middle of the left shoulder.



	N	Minimum	Maximum	Mean	Std Dev	CV %
Small Female	25	65.9 (25.9)	70.4 (27.7)	68.2 (26.8)	1.26 (cm) (0.50) (in)	1.85
Mid-Sized Male	25	69.1 (27.2)	75.2 (29.6)	72.1 (28.4)	1.52 (cm) (0.60) (in)	2.12
Large Male	25	71.8 (28.3)	77.2 (30.4)	74.7 (29.4)	1.51 (cm) (0.59) (in)	2.02

ACROMION HEIGHT

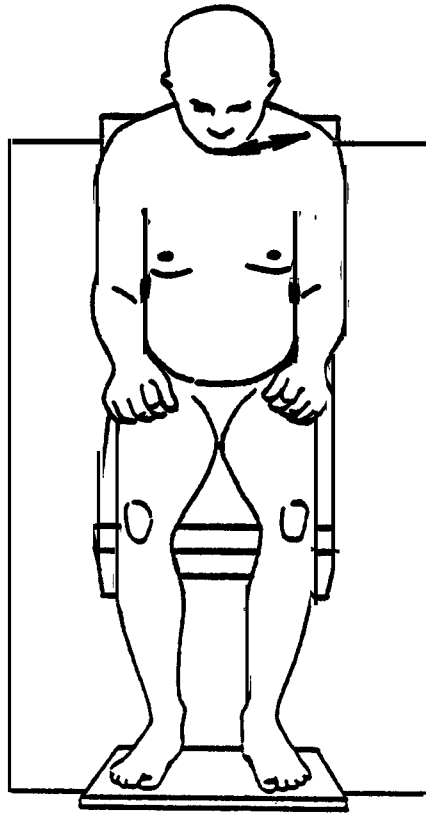
The subject sits in the contoured hardseat, feet placed firmly on the toeboard, hands on the steering wheel at the 10 o'clock and 2 o'clock positions, the head and body in a relaxed driving posture. Use an anthropometer to measure the vertical distance from the reference surface to the left acromion landmark. (The acromion landmark is a point on the surface of the skin obtained by palpating the most lateral margin of the acromial process of the scapula.)



	N	Minimum	Maximum	Mean	Std Dev	CV %
Small Female	25	61.1 (24.0)	66.6 (26.2)	64.3 (25.3)	1.31 (cm) (0.52) (in)	2.04
Mid-Sized Male	25	65.5 (25.8)	71.3 (28.1)	68.3 (26.9)	1.77 (cm) (0.70) (in)	2.58
Large Male	25	66.3 (26.1)	75.4 (29.7)	70.5 (27.8)	2.26 (cm) (0.89) (in)	3.20

CLAVICALE-TO-ACROMIO-CLAVICULAR ARTICULATION

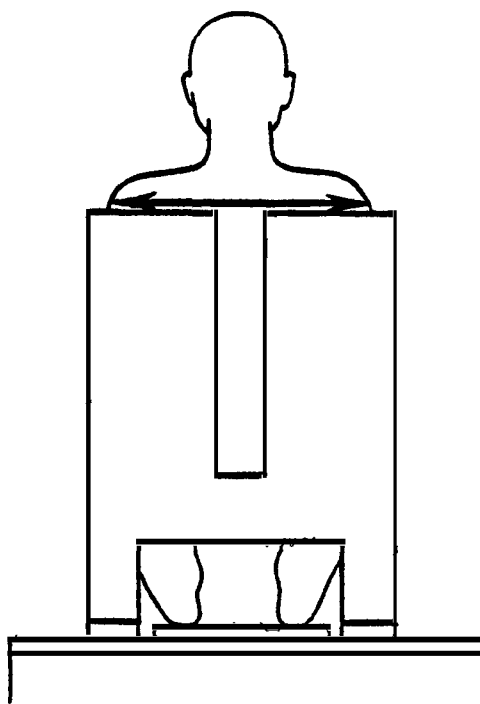
The subject sits in the contoured hardseat, feet placed firmly on the toeboard, hands on the steering wheel at the 10 o'clock and 2 o'clock positions, the head and body in a relaxed driving posture. Use an anthropometer to measure the distance between the left clavicale landmark and the left acromio-clavicular articulation landmark. (The clavicale landmark is a point on the surface of the skin obtained by palpating the most superior margin on the medial border of the clavicle at the articulation with the manubrium of the sternum. The acromio-clavicular articulation landmark is a point on the surface of the skin obtained by palpating the midpoint of articulation between the lateral margins of the clavicle and the acromial process of the scapula.)



	N	Minimum	Maximum	Mean	Std Dev	CV %
Small Female	25	13.7 (5.4)	17.7 (7.0)	15.5 (6.1)	1.08 (cm) (0.43) (in)	7.01
Mid-Sized Male	25	15.9 (6.3)	18.7 (7.4)	17.4 (6.8)	0.79 (cm) (0.31) (in)	4.57
Large Male	24	17.2 (6.8)	20.7 (8.1)	19.1 (7.5)	1.05 (cm) (0.41) (in)	5.51

SHOULDER BREADTH

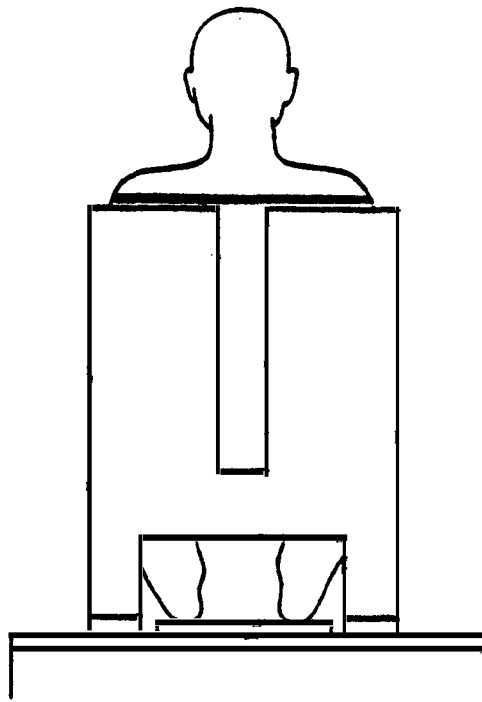
The subject sits in the contoured hardseat, feet placed firmly on the toeboard, hands on the steering wheel at the 10 o'clock and 2 o'clock positions, the head and body in a relaxed driving posture. Use an anthropometer held horizontally to measure the maximum breadth of the shoulders across the deltoid muscles.



	N	Minimum	Maximum	Mean	Std Dev	CV %
Small Female	25	35.3 (13.9)	40.3 (15.9)	38.0 (15.0)	1.41 (cm) (0.55) (in)	3.69
Mid-Sized Male	25	42.5 (16.7)	48.9 (19.3)	46.8 (18.4)	1.49 (cm) (0.59) (in)	3.18
Large Male	25	45.7 (18.0)	56.1 (22.1)	50.2 (19.8)	2.60 (cm) (1.02) (in)	5.17

SHOULDER CIRCUMFERENCE

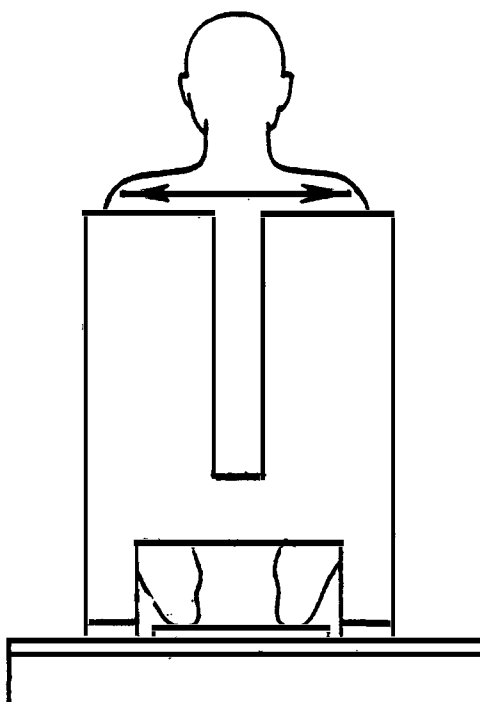
The subject sits in the contoured hardseat, feet placed firmly on the toeboard, hands on the steering wheel at the 10 o'clock and 2 o'clock positions, the head and body in a relaxed driving posture. Use a steel tape to measure the maximum circumference of the shoulders in a horizontal plane at the level of the deltoid muscles during mid-inhalation.



	N	Minimum	Maximum	Mean	Std Dev	CV %
Small Female	24	87.0 (34.3)	102.2 (40.2)	95.3 (37.5)	3.87 (cm) (1.52) (in)	4.06
Mid-Sized Male	25	114.0 (44.8)	126.9 (49.9)	120.0 (47.2)	3.47 (cm) (1.37) (in)	2.90
Large Male	25	122.8 (48.3)	145.8 (57.4)	131.7 (51.8)	5.79 (cm) (2.28) (in)	4.40

BIACROMIAL BREADTH

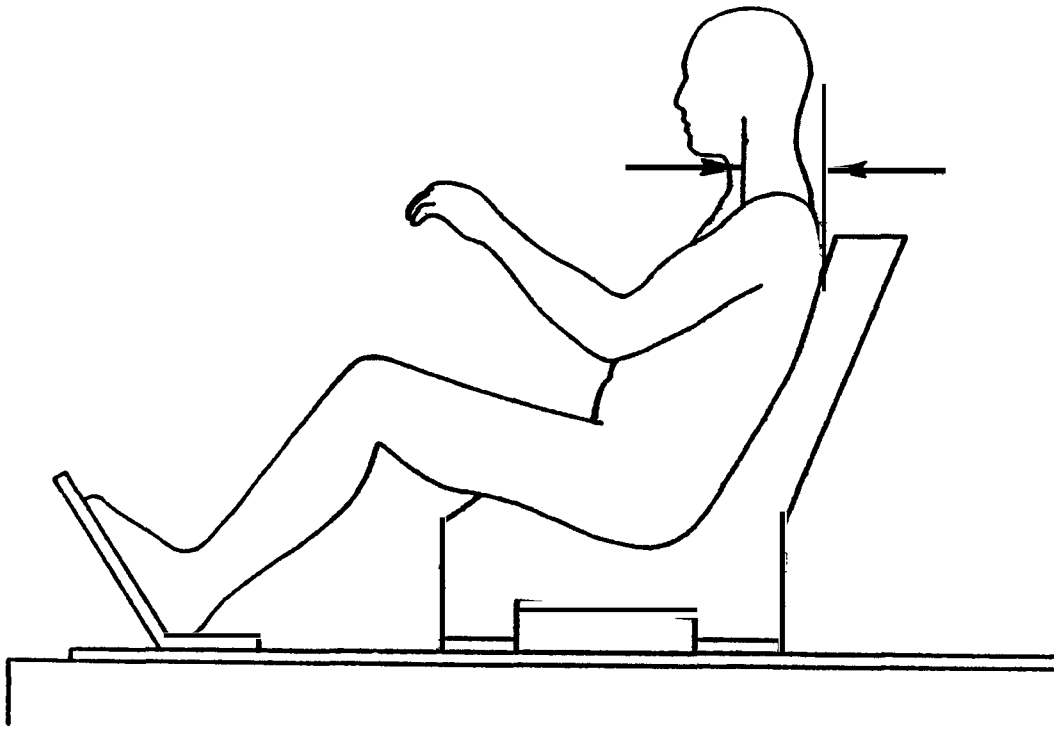
The subject sits in the contoured hardseat, feet placed firmly on the toeboard, hands on the steering wheel at the 10 o'clock and 2 o'clock positions, the head and body in a relaxed driving posture. Use an anthropometer held horizontally to measure the distance between left and right acromion landmarks. (The acromion landmark is a point on the surface of the skin obtained by palpating the most lateral margin of the acromial process of the scapula.)



	N	Minimum	Maximum	Mean	Std Dev	CV %
Small Female	25	31.5 (12.4)	36.7 (14.4)	34.2 (13.5)	1.46 (cm) (0.57) (in)	4.26
Mid-Sized Male	23	38.5 (15.2)	42.7 (16.8)	40.7 (16.0)	1.21 (cm) (0.48) (in)	2.98
Large Male	25	36.5 (14.4)	47.0 (18.5)	43.4 (17.1)	2.26 (cm) (0.89) (in)	5.20

TORSO DEPTH (upper)

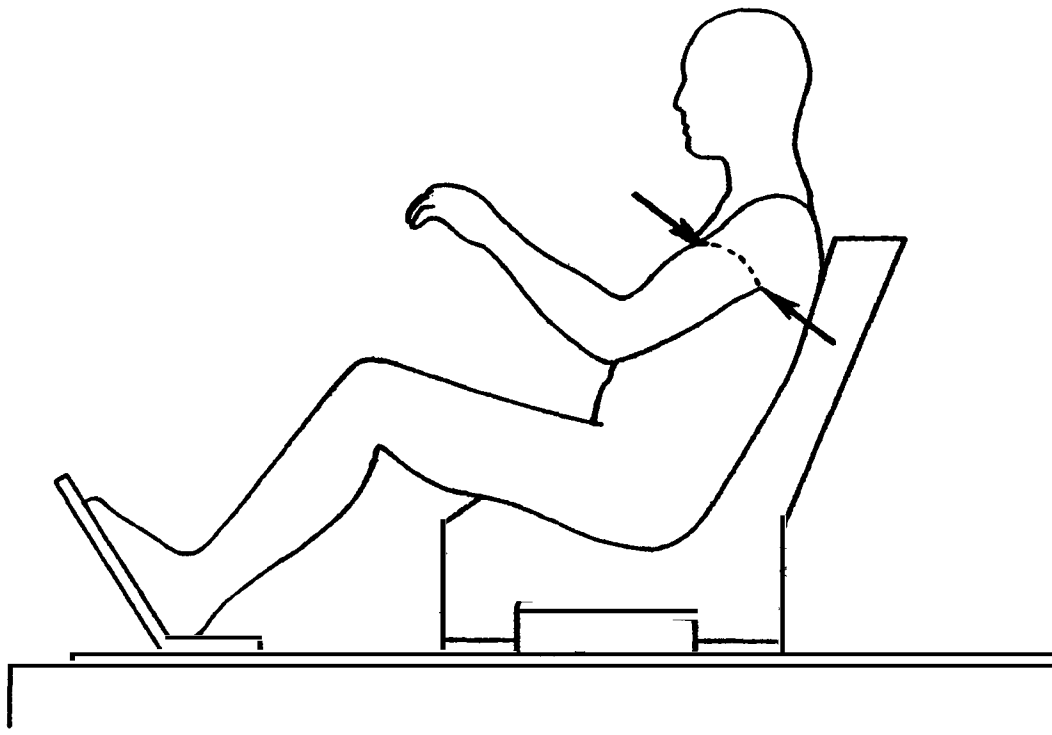
The subject sits in the contoured hardseat, feet placed firmly on the toeboard, hands on the steering wheel at the 10 o'clock and 2 o'clock positions, the head and body in relaxed driving posture. Use an anthropometer held horizontally to measure the depth of the upper torso between the midpoint of the left clavicle and left scapular spine.



	N	Minimum	Maximum	Mean	Std Dev	CV %
Small Female	25	7.4 (2.9)	11.0 (4.3)	9.0 (3.5)	1.10 (cm) (0.43) (in)	12.25
Mid-Sized Male	25	10.1 (4.0)	14.6 (5.7)	11.9 (4.7)	1.20 (cm) (0.47) (in)	10.05
Large Male	25	11.1 (4.4)	15.5 (6.1)	13.8 (5.4)	1.06 (cm) (0.42) (in)	7.67

SHOULDER DEPTH (scye)

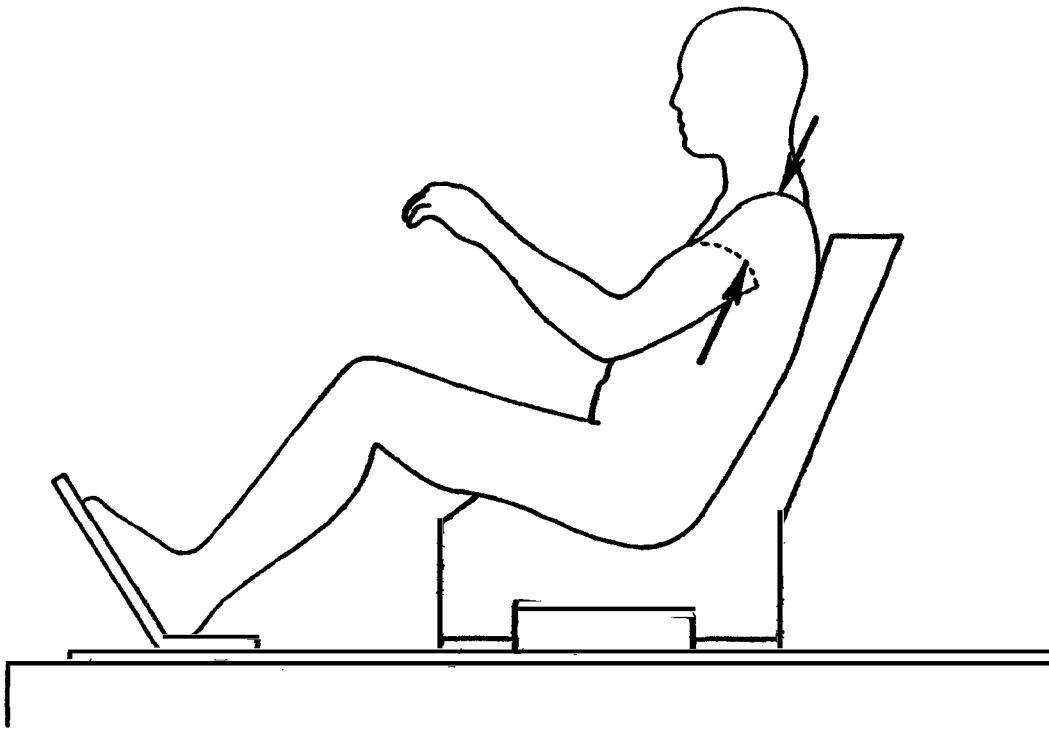
The subject sits in the contoured hardseat, feet placed firmly on the toeboard, hands on the steering wheel at the 10 o'clock and 2 o'clock positions, the head and body in a relaxed driving posture. Use an anthropometer to measure the depth of the left shoulder between the scye anterior and posterior landmarks. (The scye landmarks are points on the surface of the skin at the anterior-superior and posterior-superior margins of the skin furrow formed by the juncture of the upper arm and torso, i.e., marking the axillary folds.)



	N	Minimum	Maximum	Mean	Std Dev	CV %
Small Female	25	9.6 (3.8)	11.9 (4.7)	10.5 (4.1)	0.61 (cm) (0.24) (in)	5.84
Mid-Sized Male	25	12.9 (5.1)	16.5 (6.5)	14.5 (5.7)	0.97 (cm) (0.38) (in)	6.69
Large Male	25	15.1 (5.9)	19.3 (7.6)	16.7 (6.6)	1.19 (cm) (0.47) (in)	7.10

AXILLARY DEPTH

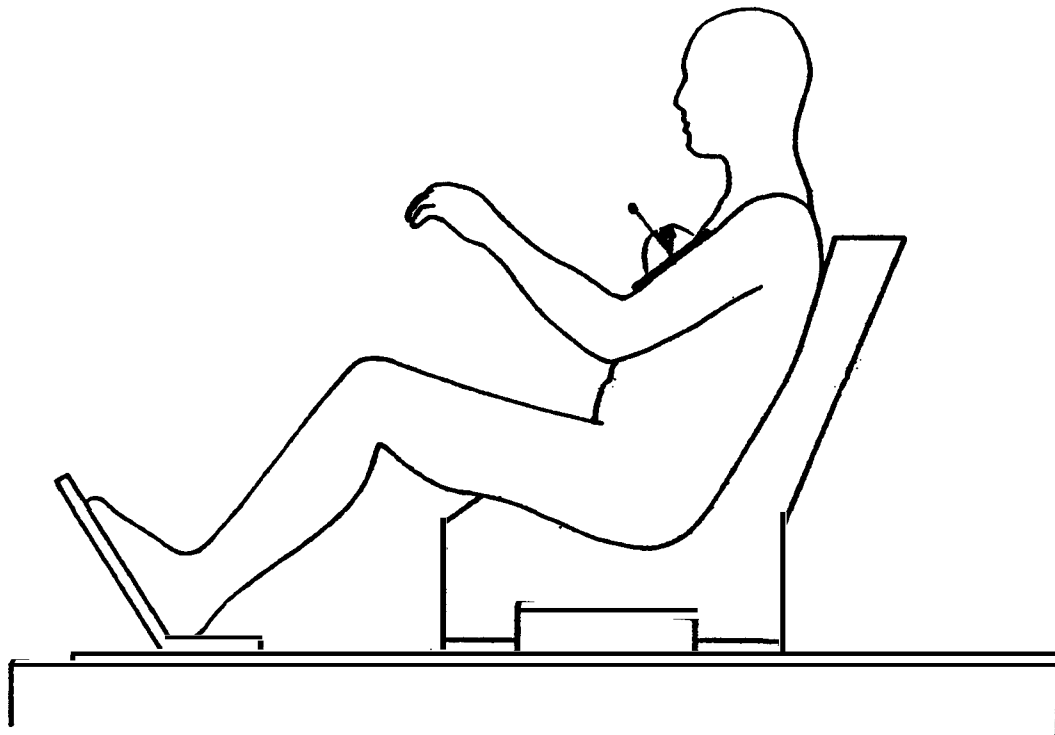
The subject sits in the contoured hardseat, feet placed firmly on the toeboard, hands on the steering wheel at the 10 o'clock and 2 o'clock positions, the head and body in a relaxed driving posture. Use an anthropometer with curved blades to measure the depth from the most superior point of the left axilla (armpit) to the left acromio-clavicular articulation landmark. The subject raises the left arm slightly while the anthropometer is positioned, and then lowers the arm before the measurement is taken. (The acromio-clavicular articulation landmark is a point on the surface of the skin obtained by palpating the midpoint of articulation between the lateral margins of the clavicle and acromial process of the scapula.)



	N	Minimum	Maximum	Mean	Std Dev	CV %
Small Female	25	7.8 (3.1)	12.6 (5.0)	9.8 (3.8)	1.27 (cm) (0.50) (in)	12.98
Mid-Sized Male	25	9.9 (3.9)	13.9 (5.5)	11.7 (4.6)	1.04 (cm) (0.41) (in)	8.85
Large Male	25	11.1 (4.4)	15.7 (6.2)	13.3 (5.2)	1.00 (cm) (0.39) (in)	7.46

ARM ANGLE (upper)

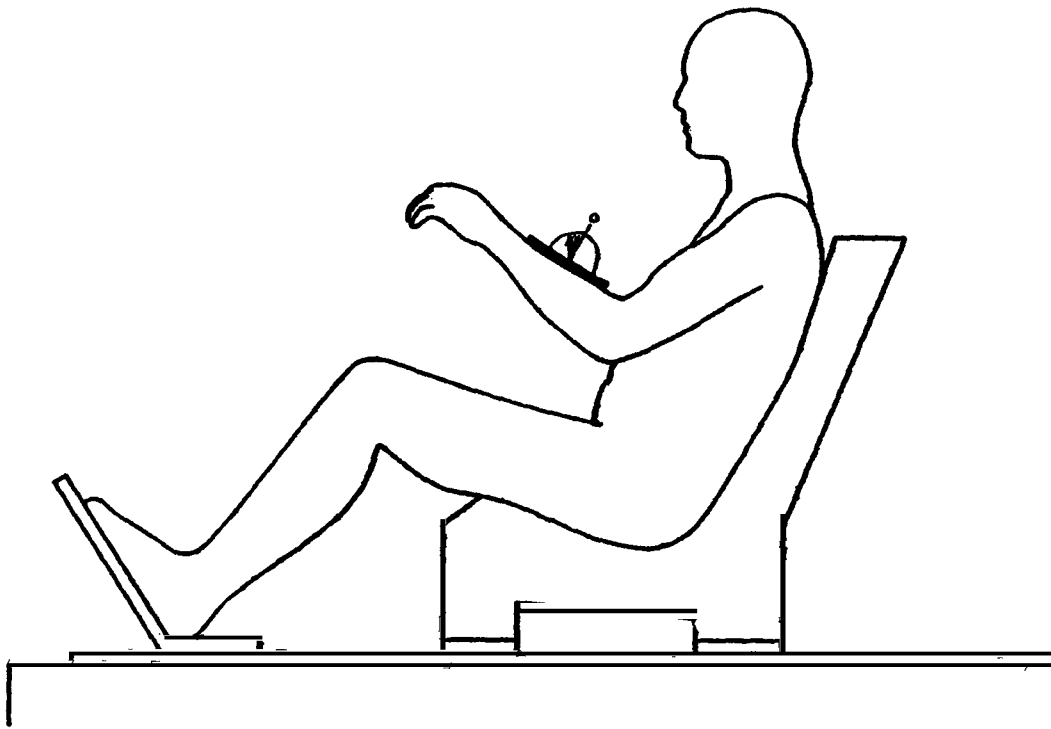
The subject sits in the contoured hardseat, feet placed firmly on the toeboard, hands on the steering wheel at the 10 o'clock and 2 o'clock positions, the head and body in a relaxed driving posture. Place the flat surface of a modified "inclinometer" on the upper surface of the left upper arm, along its long axis. Read the angle of the needle which is the angle of the upper arm to the horizontal.



	N	Minimum	Maximum	Mean	Std Dev	CV %
Small Female	25	36.0 (14.2)	53.0 (20.9)	43.3 (17.1)	4.74 (cm) (1.87) (in)	10.94
Mid-Sized Male	25	29.0 (11.4)	52.0 (20.5)	40.4 (15.9)	6.04 (cm) (2.38) (in)	14.94
Large Male	25	26.0 (10.2)	50.0 (19.7)	36.7 (14.4)	5.90 (cm) (2.32) (in)	16.09

ARM ANGLE (lower)

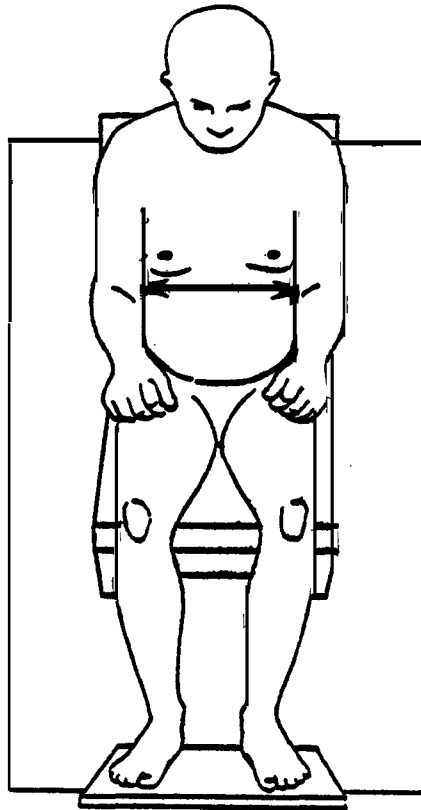
The subject sits in the contoured hardseat, feet placed firmly on the toeboard, hands on the steering wheel at the 10 o'clock and 2 o'clock positions, the head and body in a relaxed driving posture. Place the flat surface of a modified "inclinometer" on the upper surface of the left forearm, along its long axis. Read the angle of the needle which is the angle of the forearm to the horizontal.



	N	Minimum	Maximum	Mean	Std Dev		CV %
Small Female	25	31.0 (12.2)	62.0 (24.4)	50.4 (19.9)	7.11 (cm) (2.80) (in)		14.09
Mid-Sized Male	25	28.0 (11.0)	42.0 (16.5)	35.9 (14.1)	3.94 (cm) (1.55) (in)		10.97
Large Male	25	12.0 (4.7)	38.0 (15.0)	23.9 (9.4)	7.05 (cm) (2.78) (in)		29.52

RIGHT-LEFT MEDIAL HUMERAL EPICONDYLE

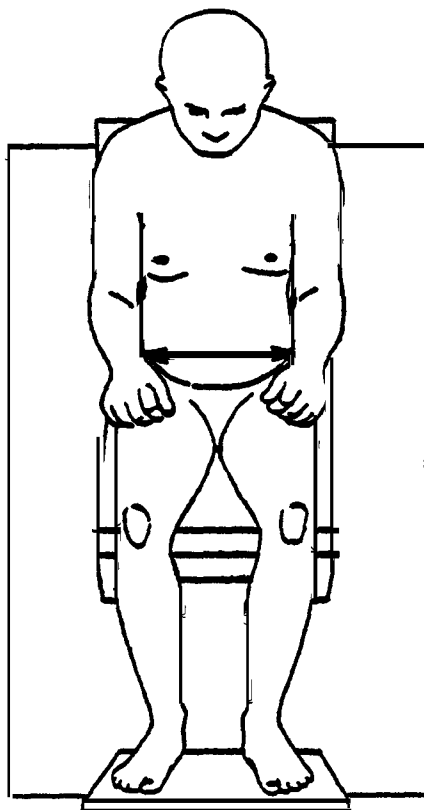
The subject sits in the contoured hardseat, feet placed firmly on the toeboard, hands on the steering wheel at the 10 o'clock and 2 o'clock positions, the head and body in a relaxed driving posture. Use an anthropometer, with blades reversed, to measure the horizontal distance between the right and left medial humeral epicondyle landmarks. Add two centimeters to the measured value to correct for the reversed blades. (The medial humeral epicondyle landmark is a point on the surface of the skin obtained by palpating the most prominent aspect of the medial epicondyle of the humerus.)



	N	Minimum	Maximum	Mean	Std Dev	CV %
Small Female	25	24.8 (9.8)	39.8 (15.7)	30.0 (11.8)	3.15 (cm) (1.24) (in)	10.52
Mid-Sized Male	25	30.6 (12.0)	38.1 (15.0)	33.8 (13.3)	2.19 (cm) (0.86) (in)	6.48
Large Male	25	31.9 (12.5)	45.2 (17.8)	37.8 (14.9)	3.15 (cm) (1.24) (in)	8.33

RIGHT-LEFT STYLION

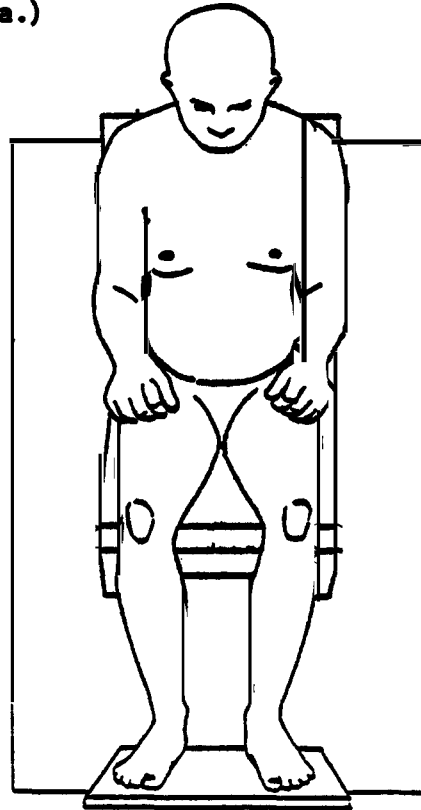
The subject sits in the contoured hardseat, feet placed firmly on the toeboard, hands on the steering wheel at the 10 o'clock and 2 o'clock positions, the head and body in a relaxed driving posture. Use an anthropometer with blades reversed, to measure the horizontal distance between the right and left stylium landmarks. Add two centimeters to the measured value to correct for the reversed blades. (The stylium landmark is a point on the surface of the skin obtained by palpating the most distal margin of the stylioid process of the radius.)



	N	Minimum	Maximum	Mean	Std Dev	CV %
Small Female	25	23.4 (9.2)	34.7 (13.7)	27.2 (10.7)	2.56 (cm) (1.01) (in)	9.43
Mid-Sized Male	25	23.6 (9.3)	30.2 (11.9)	27.0 (10.6)	1.74 (cm) (0.69) (in)	6.46
Large Male	25	23.6 (9.3)	32.7 (12.9)	27.6 (10.9)	2.39 (cm) (0.94) (in)	8.65

ARM CIRCUMFERENCE (scye)

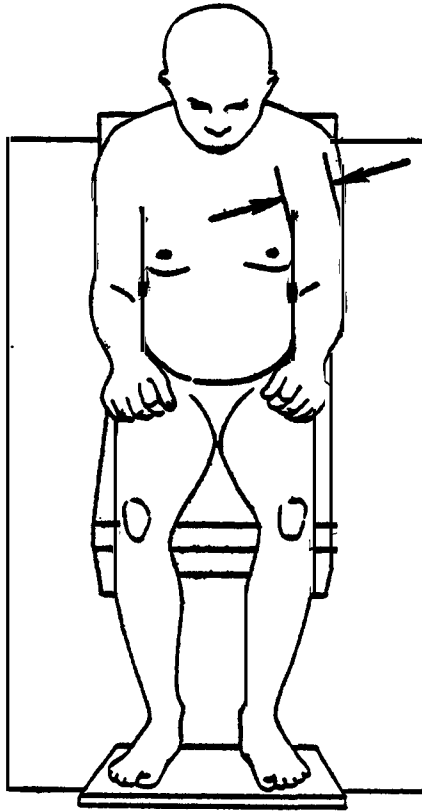
The subject sits in the contoured hardseat, feet placed firmly on the toeboard, hands on the steering wheel at the 10 o'clock and 2 o'clock positions, the head and body in a relaxed driving posture. Use a steel tape to measure the circumference at the juncture of the left upper arm and shoulder in the plane formed by the scye anterior and posterior landmarks and the acromio-clavicular articulation landmark. (The scye anterior and posterior landmarks are points on the surface of the skin at the anterior-superior and posterior-superior margins of the skin furrow formed by the juncture of the upper arm and torso, i.e., the axillary folds. The acromio-clavicular articulation landmark is a point on the surface of the skin obtained by palpating the midpoint of articulation between the lateral margin of the clavicle and the acromial process of the scapula.)



	N	Minimum	Maximum	Mean	Std Dev	CV %
Small Female	25	33.0 (13.0)	42.0 (16.5)	36.9 (14.5)	2.19 (cm) (0.86) (in)	5.95
Mid-Sized Male	25	41.7 (16.4)	51.4 (20.2)	45.3 (17.8)	2.48 (cm) (0.98) (in)	5.48
Large Male	25	46.2 (18.2)	55.3 (21.8)	50.6 (19.9)	2.27 (cm) (0.89) (in)	4.48

ARM BREADTH (upper)

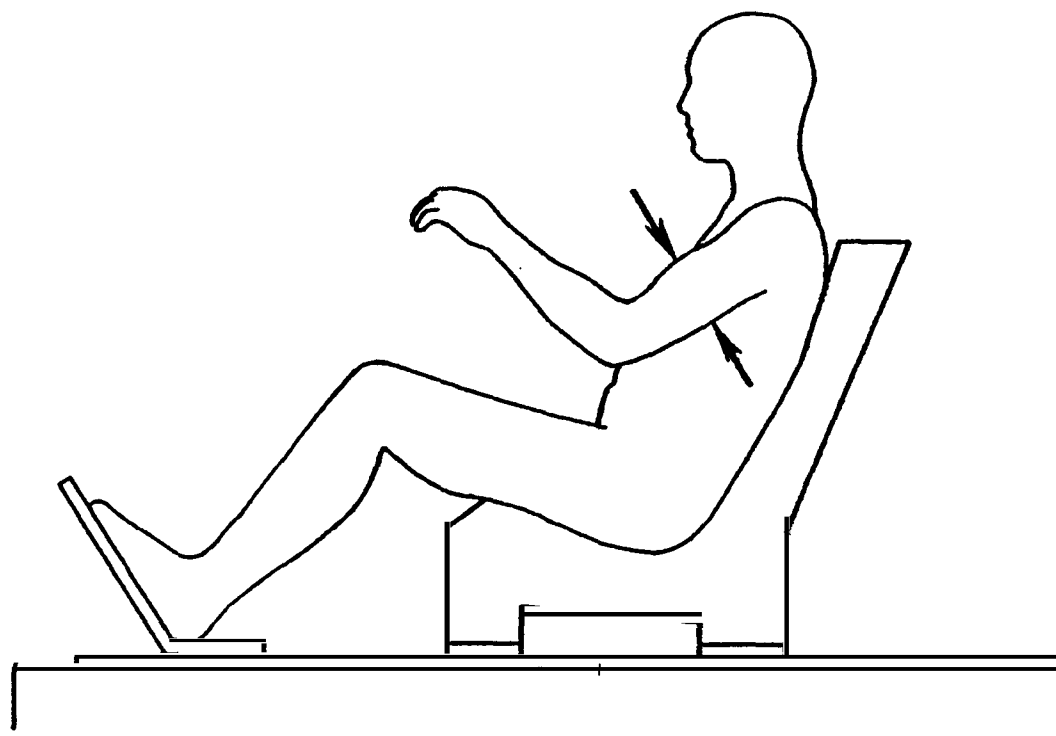
The subject sits in the contoured hardseat, feet placed firmly on the toeboard, hands on the steering wheel at the 10 o'clock and 2 o'clock positions, the head and body in a relaxed driving posture. Use an anthropometer held perpendicular to the long axis of the left upper arm to measure the maximum arm breadth across the biceps muscle at the level of the arm upper landmark. (The arm upper landmark is a point marked on the lateral surface of the upper arm at the estimated maximum circumference).



	N	Minimum	Maximum	Mean	Std Dev	CV %
Small Female	25	5.8 (2.3)	7.6 (3.0)	6.7 (2.6)	0.45 (cm) (0.18) (in)	6.69
Mid-Sized Male	25	7.3 (2.9)	9.6 (3.8)	8.6 (3.4)	0.62 (cm) (0.24) (in)	7.17
Large Male	25	8.0 (3.1)	11.3 (4.4)	9.8 (3.9)	0.71 (cm) (0.28) (in)	7.22

ARM DEPTH (upper)

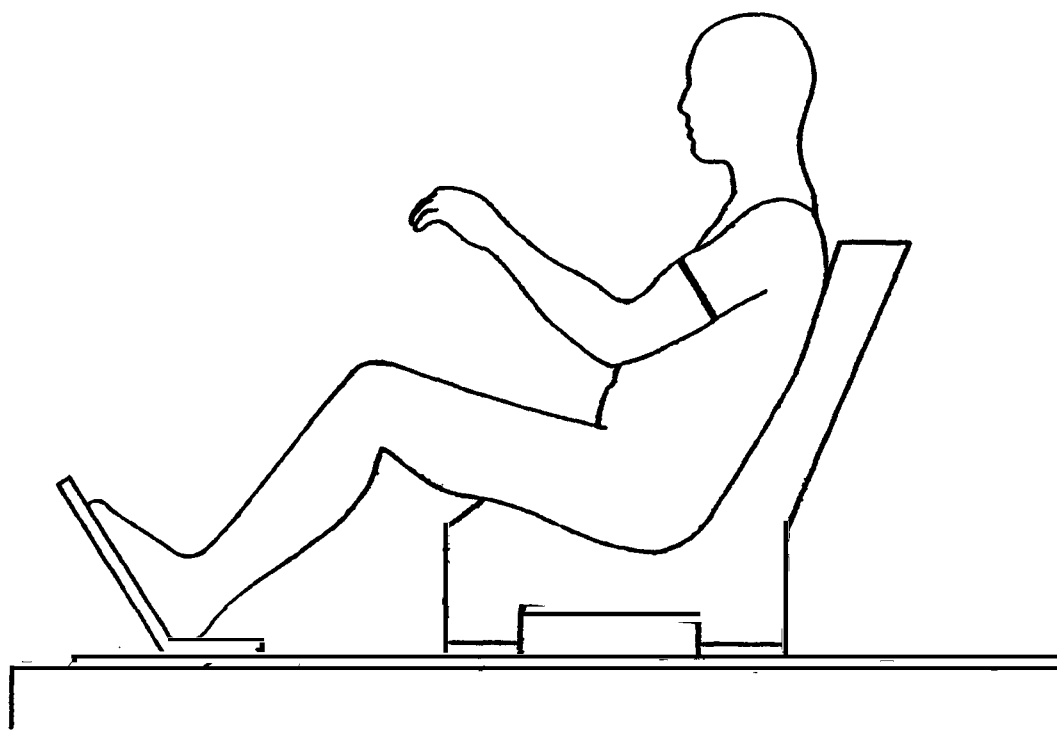
The subject sits in the contoured hardseat, feet placed firmly on the toeboard, hands on the steering wheel at the 10 o'clock and 2 o'clock positions, the head and body in a relaxed driving posture. Use an anthropometer held perpendicular to the long axis of the left upper arm to measure the maximum arm depth at the level of the arm upper landmark. (The arm upper landmark is a point marked on the lateral surface of the upper arm at the estimated maximum circumference.)



	N	Minimum	Maximum	Mean	Std Dev	CV %
Small Female	25	7.6 (3.0)	10.4 (4.1)	8.9 (3.5)	0.77 (cm) (0.30) (in)	8.71
Mid-Sized Male	25	7.6 (3.0)	13.3 (5.2)	10.8 (4.3)	1.05 (cm) (0.41) (in)	9.70
Large Male	25	10.6 (4.2)	14.3 (5.6)	12.5 (4.9)	1.05 (cm) (0.41) (in)	8.36

ARM CIRCUMFERENCE (upper)

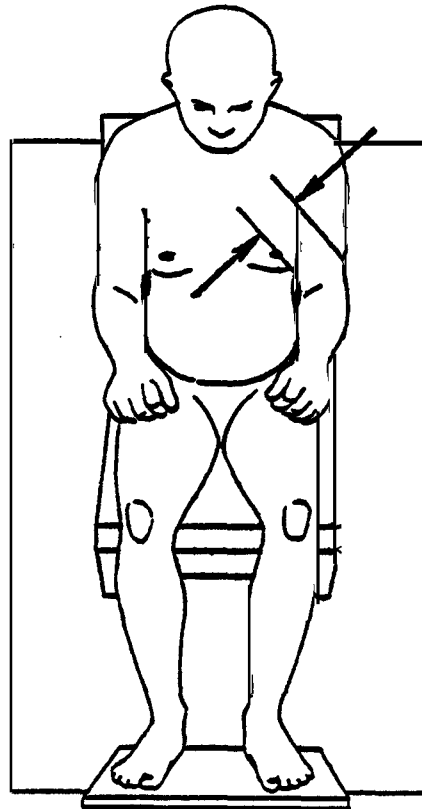
The subject sits in the contoured hardseat, feet placed firmly on the toeboard, hands on the steering wheel at the 10 o'clock and 2 o'clock positions, the head and body in a relaxed driving posture. Use a steel tape to measure the circumference of the left upper arm in a plane perpendicular to the long axis of the upper arm at the arm upper landmark. (The arm upper landmark is a point marked on the lateral surface of the upper arm at the estimated maximum circumference.)



	N	Minimum	Maximum	Mean	Std Dev	CV %
Small Female	25	22.5 (8.9)	27.9 (11.0)	25.3 (10.0)	1.52 (cm) (0.60) (in)	6.01
Mid-Sized Male	25	29.0 (11.4)	35.0 (13.8)	31.5 (12.4)	1.66 (cm) (0.65) (in)	5.28
Large Male	25	31.1 (12.2)	40.2 (15.8)	35.8 (14.1)	2.07 (cm) (0.82) (in)	5.79

ARM BREADTH (above elbow)

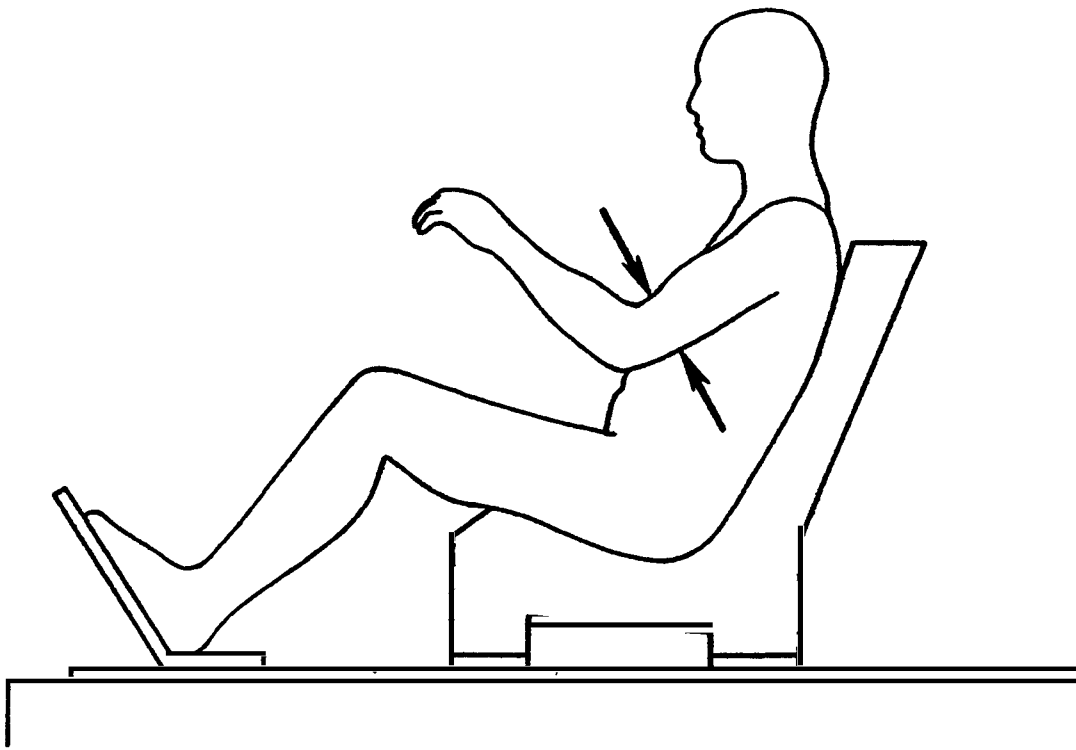
The subject sits in the contoured hardseat, feet placed firmly on the toeboard, hands on the steering wheel at the 10 o'clock and 2 o'clock positions, the head and body in a relaxed driving posture. Use an anthropometer held perpendicular to the long axis of the left upper arm to measure the breadth of the arm just proximal (above) to the antecubital crease. (The antecubital crease is formed at the juncture of the upper arm and lower arm, i.e., inside of elbow.)



	N	Minimum	Maximum	Mean	Std Dev	CV %
Small Female	25	6.4 (2.5)	8.1 (3.2)	7.2 (2.8)	0.41 (cm) (0.16) (in)	5.75
Mid-Sized Male	25	7.2 (2.8)	9.2 (3.6)	8.3 (3.3)	0.61 (cm) (0.24) (in)	7.35
Large Male	25	8.0 (3.1)	10.9 (4.3)	9.2 (3.6)	0.85 (cm) (0.34) (in)	9.26

ARM DEPTH (above elbow)

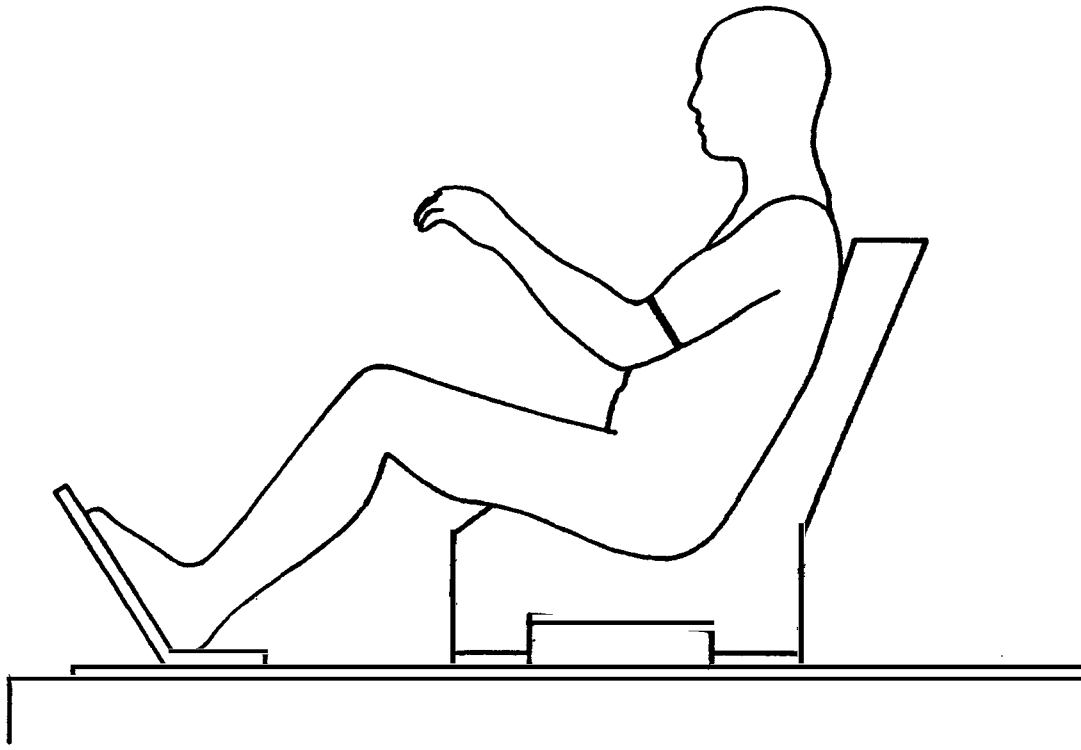
The subject sits in the contoured hardseat, feet placed firmly on the toeboard, hands on the steering wheel at the 10 o'clock and 2 o'clock positions, the head and body in a relaxed driving posture. Use an anthropometer held perpendicular to the long axis of the left upper arm to measure the arm depth just proximal (above) to the antecubital crease. (The antecubital crease is formed at the juncture of the upper arm and lower arm, i.e., inside of elbow.)



	N	Minimum	Maximum	Mean	Std Dev	CV %
Small Female	25	6.3 (2.5)	8.7 (3.4)	7.4 (2.9)	0.63 (cm) (0.25) (in)	8.45
Mid-Sized Male	25	7.2 (2.8)	9.1 (3.6)	8.2 (3.2)	0.48 (cm) (0.19) (in)	5.81
Large Male	25	8.0 (3.1)	10.8 (4.3)	9.2 (3.6)	0.72 (cm) (0.28) (in)	7.83

ARM CIRCUMFERENCE (above elbow)

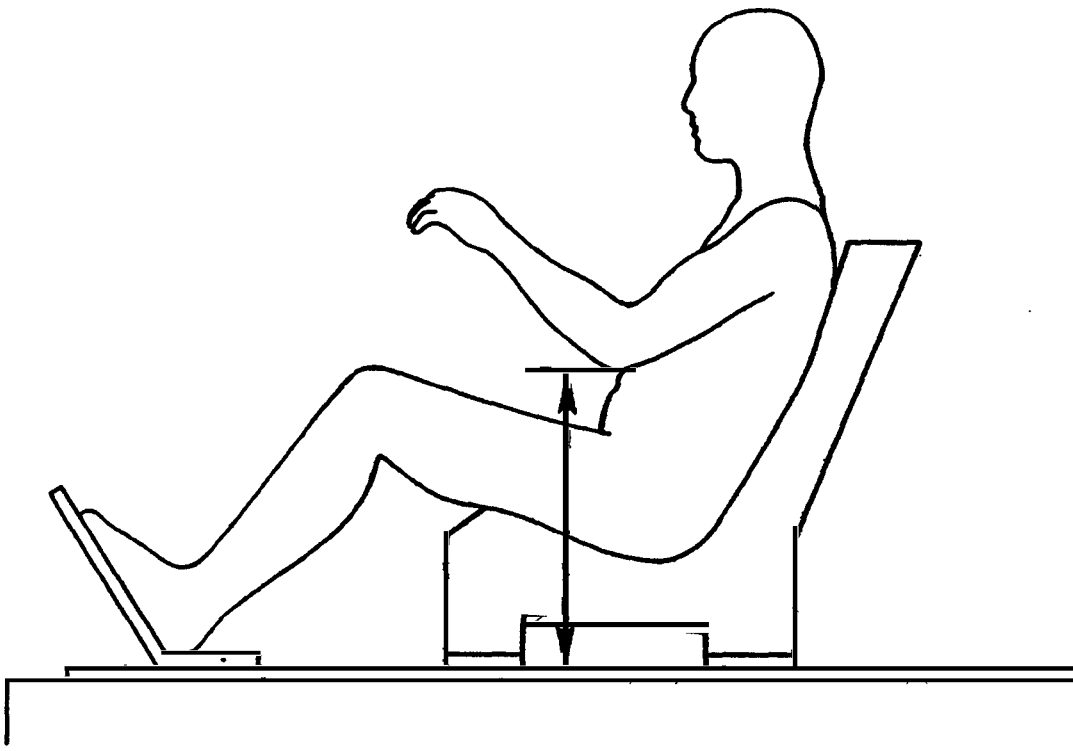
The subject sits in the contoured hardseat, feet placed firmly on the toeboard, hands on the steering wheel at the 10 o'clock and 2 o'clock positions, the head and body in a relaxed driving posture. Use a steel tape to measure the circumference of the left upper arm in a plane perpendicular to the long axis of the upper arm just proximal (above) to the antecubital crease. (The antecubital crease is formed at the juncture of the upper arm and lower arm, i.e., inside of elbow.)



	N	Minimum	Maximum	Mean	Std Dev	CV %
Small Female	25	21.2 (8.3)	27.3 (10.7)	24.0 (9.4)	1.43 (cm) (0.56) (in)	5.96
Mid-Sized Male	25	25.9 (10.2)	31.1 (12.2)	28.4 (11.2)	1.52 (cm) (0.60) (in)	5.35
Large Male	25	27.8 (10.9)	37.3 (14.7)	31.3 (12.3)	2.28 (cm) (0.90) (in)	7.28

OLECRANON HEIGHT

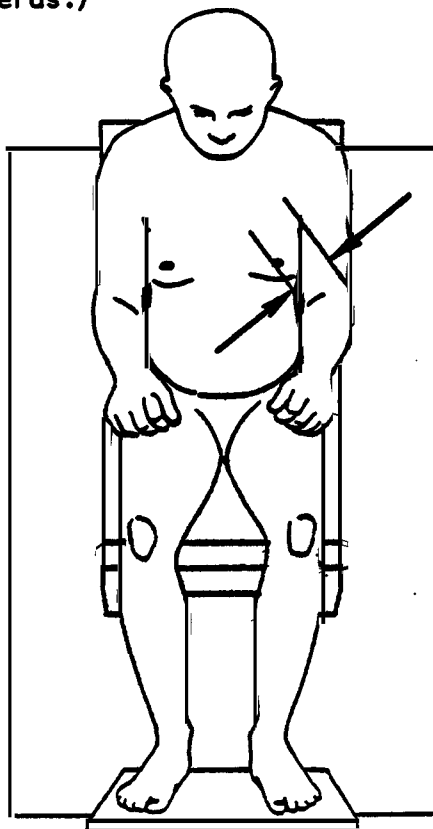
The subject sits in the contoured hardseat, feet placed firmly on the toeboard, hands on the steering wheel at the 10 o'clock and 2 o'clock positions, the head and body in a relaxed driving posture. Use an anthropometer to measure the vertical distance from the reference surface to the left olecranon landmark. (The olecranon landmark is a point on the surface of the skin obtained by palpating the most posterior-inferior margin of the olecranon process of the ulna, i.e., approximately the lowest point on the elbow.)



	N	Minimum	Maximum	Mean	Std Dev	CV %
Small Female	25	39.7 (15.6)	48.1 (18.9)	44.4 (17.5)	2.05 (cm) (0.81) (in)	4.61
Mid-Sized Male	25	41.2 (16.2)	48.2 (19.0)	45.0 (17.7)	2.03 (cm) (0.80) (in)	4.51
Large Male	25	42.7 (16.8)	52.5 (20.7)	47.6 (18.7)	2.99 (cm) (1.18) (in)	6.29

ELBOW BREADTH

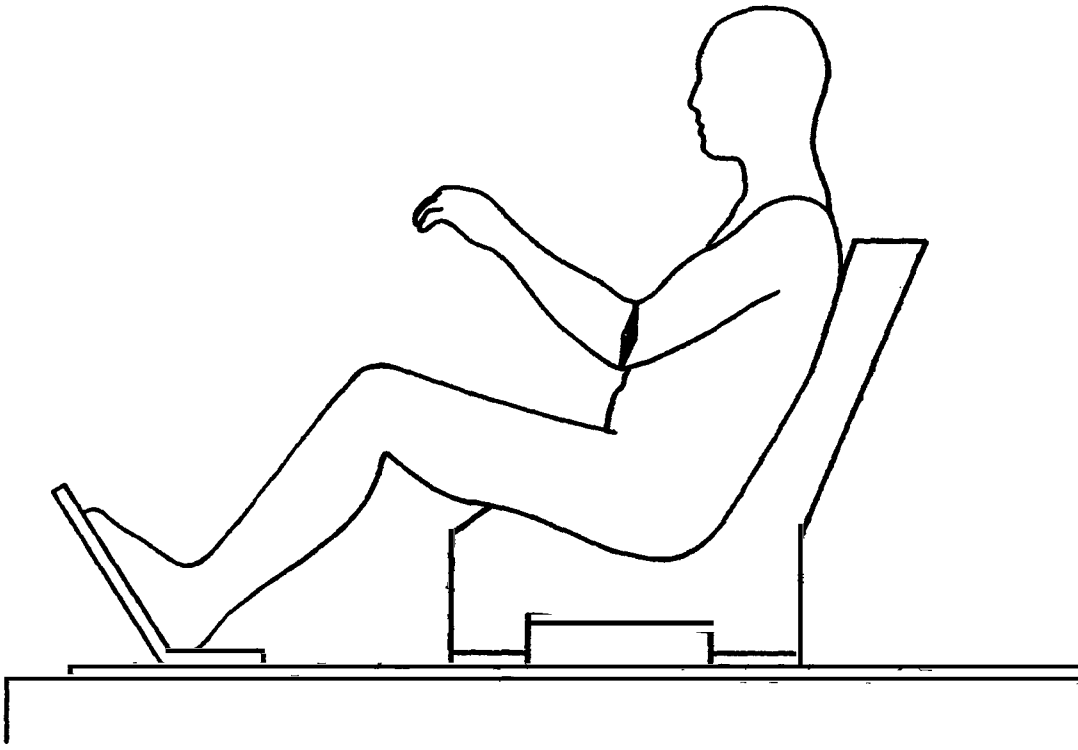
The subject sits in the contoured hardseat, feet placed firmly on the toeboard, hands on the steering wheel at the 10 o'clock and 2 o'clock positions, the head and body in a relaxed driving posture. Use an anthropometer to measure the breadth of the elbow across the medial and lateral humeral epicondyle landmarks. (The medial humeral epicondyle landmark is a point on the surface of the skin obtained by palpating the most prominent aspect of the medial epicondyle of the humerus. The lateral humeral epicondyle landmark is a point on the surface of the skin obtained by palpating the most prominent aspect of the lateral epicondyle of the humerus.)



	N	Minimum	Maximum	Mean	Std Dev	CV %
Small Female	25	5.6 (2.2)	7.1 (2.8)	6.4 (2.5)	0.36 (cm) (0.14) (in)	5.69
Mid-Sized Male	25	7.1 (2.8)	8.9 (3.5)	8.0 (3.2)	0.42 (cm) (0.16) (in)	5.19
Large Male	25	7.6 (3.0)	10.0 (3.9)	8.5 (3.4)	0.59 (cm) (0.23) (in)	6.86

ELBOW DEPTH

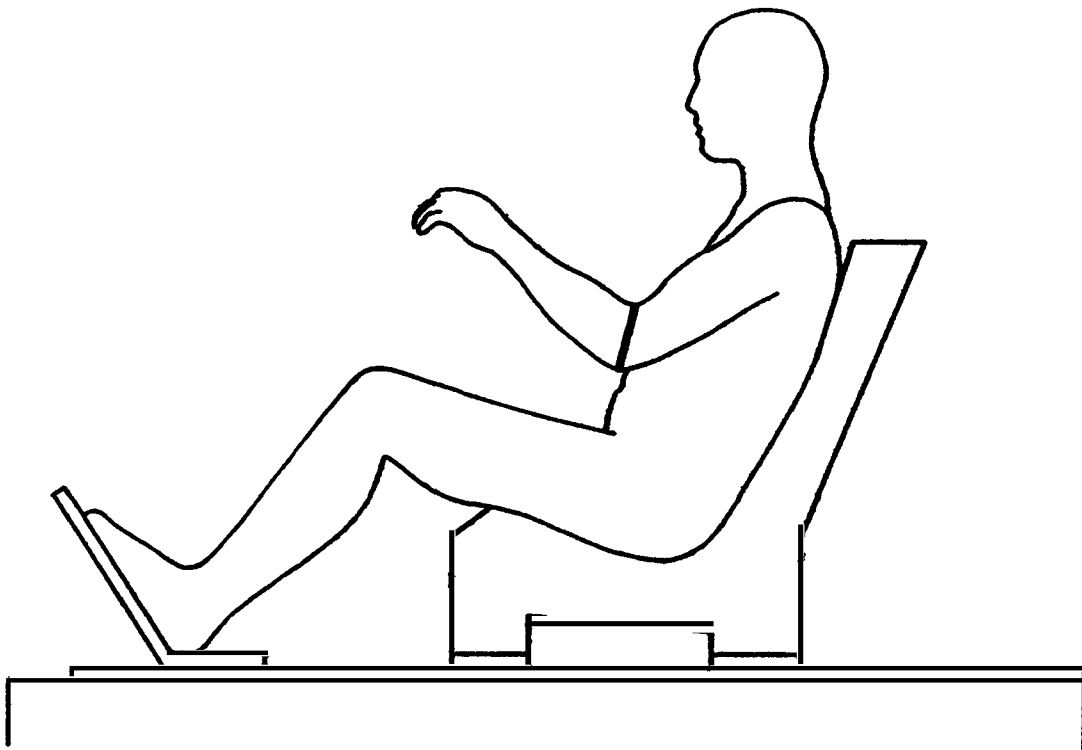
The subject sits in the contoured hardseat, feet placed firmly on the toeboard, hands on the steering wheel at the 10 o'clock and 2 o'clock positions, the head and body in a relaxed driving posture. Use an anthropometer to measure the depth of the left elbow from the antecubital crease to the olecranon landmark. (The antecubital crease is formed at the juncture of the upper arm and lower arm, i.e., inside of elbow. The olecranon landmark is a point marked on the surface of the skin obtained by palpating the most posterior-inferior margin of the olecranon process of the ulna, i.e., approximately the lowest point on the elbow.)



	N	Minimum	Maximum	Mean	Std Dev		CV %
Small Female	25	6.2 (2.4)	8.6 (3.4)	7.7 (3.0)	0.54 (0.21)	(cm) (in)	7.00
Mid-Sized Male	25	8.1 (3.2)	9.8 (3.9)	9.2 (3.6)	0.42 (0.17)	(cm) (in)	4.55
Large Male	25	8.7 (3.4)	11.0 (4.3)	9.5 (3.8)	0.57 (0.22)	(cm) (in)	5.95

ELBOW CIRCUMFERENCE

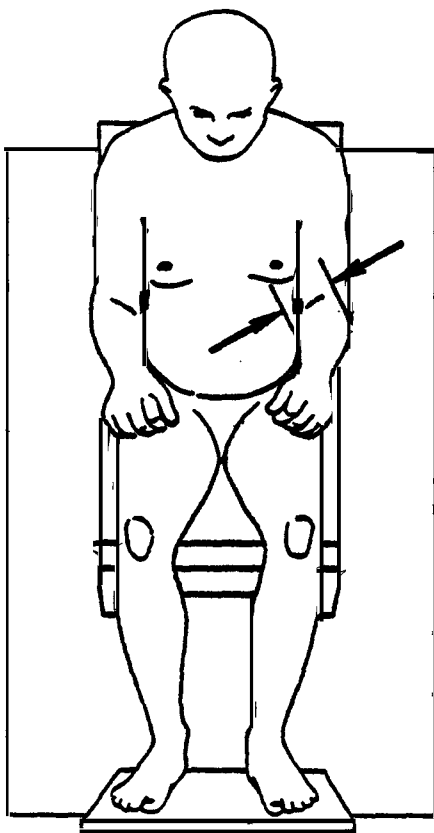
The subject sits in the contoured harseat, feet placed firmly on the toeboard, hands on the steering wheel at the 10 o'clock and 2 o'clock positions, the head and body in a relaxed driving posture. Use a steel tape to measure the circumference of the left elbow in the plane of the antecubital crease and the olecranon landmark. (The antecubital crease is formed at the juncture of the upper arm and lower arm, i.e., inside of elbow. The olecranon landmark is a point on the surface of the skin obtained by palpating the most posterior-inferior margin of the olecranon process of the ulna, i.e., approximately the lowest point on the elbow.)



	N	Minimum	Maximum	Mean	Std Dev	CV %
Small Female	25	21.5 (8.5)	25.4 (10.0)	23.3 (9.2)	1.04 (cm) (0.41) (in)	4.46
Mid-Sized Male	25	26.2 (10.3)	30.3 (11.9)	28.5 (11.2)	1.07 (cm) (0.42) (in)	3.75
Large Male	25	28.2 (11.1)	33.9 (13.3)	30.4 (11.9)	1.50 (cm) (0.59) (in)	4.93

FOREARM BREADTH (upper)

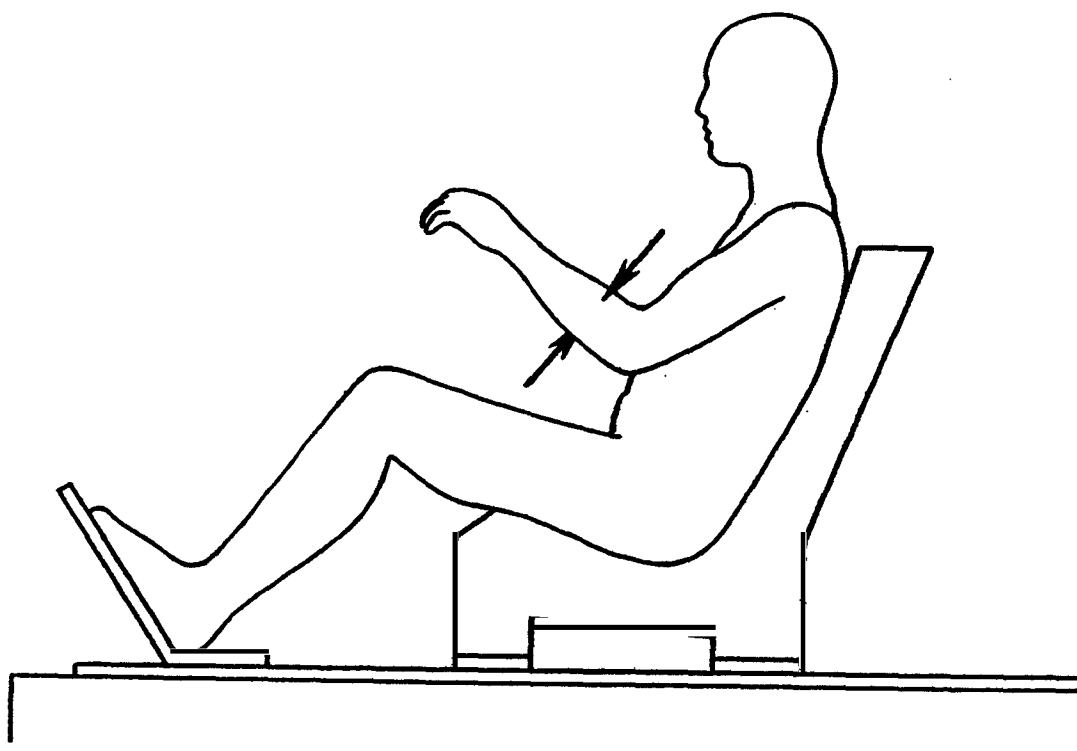
The subject sits in the contoured hardseat, feet placed firmly on the toeboard, hands on the steering wheel at the 10 o'clock and 2 o'clock positions, the head and body in a relaxed driving posture. Use an anthropometer held perpendicular to the long axis of the left forearm to measure the breadth of the forearm at the forearm upper landmark. (The forearm upper landmark is a point marked on the lateral surface of the forearm at the estimated maximum circumference.)



	N	Minimum	Maximum	Mean	Std Dev	CV %
Small Female	25	5.5 (2.2)	7.1 (2.8)	6.2 (2.4)	0.40 (cm) (0.16) (in)	6.54
Mid-Sized Male	25	7.2 (2.8)	9.1 (3.6)	8.2 (3.2)	0.51 (cm) (0.20) (in)	6.26
Large Male	25	7.8 (3.1)	9.7 (3.8)	8.5 (3.4)	0.48 (cm) (0.19) (in)	5.66

FOREARM DEPTH (upper)

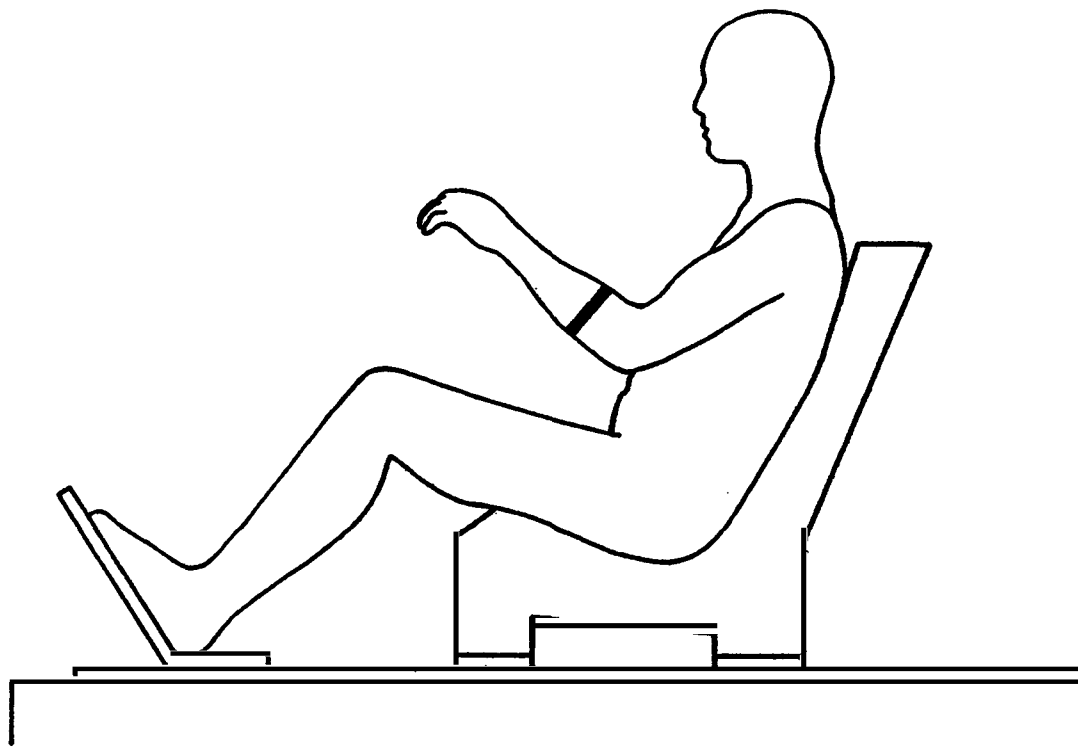
The subject sits in the contoured hardseat, feet placed firmly on the toeboard, hands on the steering wheel at the 10 o'clock and 2 o'clock positions, the head and body in a relaxed driving posture. Use an anthropometer held perpendicular to the long axis of the left forearm to measure the depth of the forearm at the forearm upper landmark. (The forearm upper landmark is a point marked on the lateral surface of the forearm at the estimated maximum circumference.)



	N	Minimum	Maximum	Mean	Std Dev	CV %
Small Female	25	6.1 (2.4)	7.7 (3.0)	6.9 (2.7)	0.41 (cm) (0.16) (in)	5.91
Mid-Sized Male	25	7.9 (3.1)	9.5 (3.7)	8.6 (3.4)	0.45 (cm) (0.18) (in)	5.26
Large Male	25	8.1 (3.2)	11.1 (4.4)	9.2 (3.6)	0.66 (cm) (0.26) (in)	7.16

FOREARM CIRCUMFERENCE (upper)

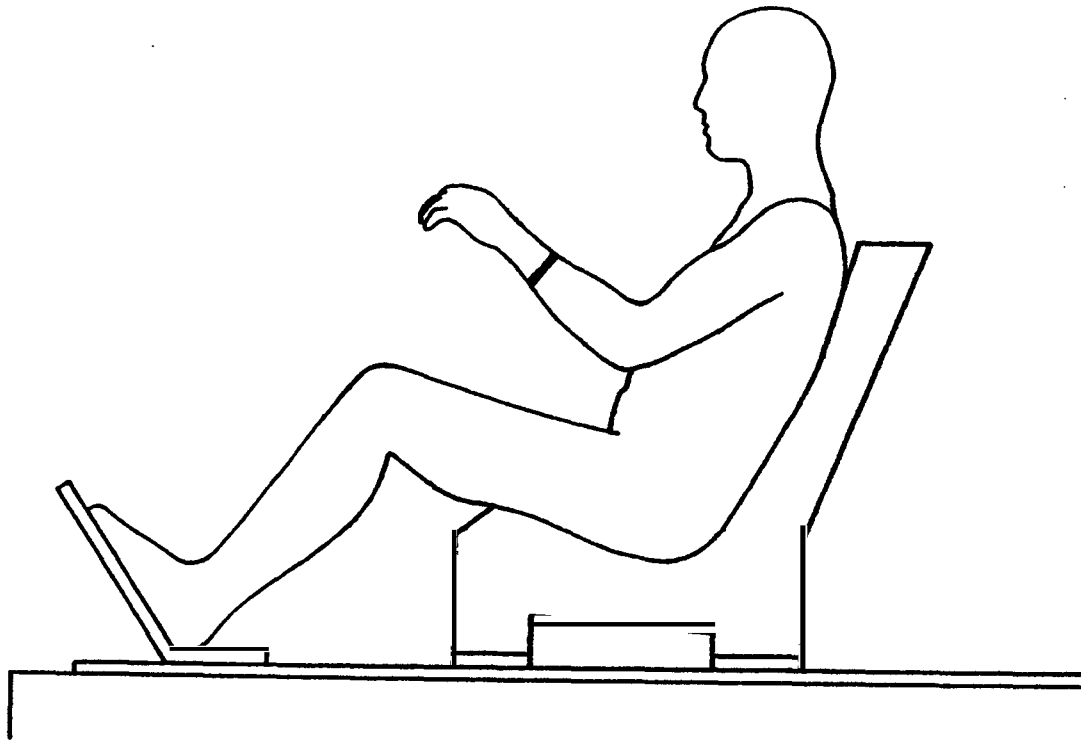
The subject sits in the contoured hardseat, feet placed firmly on the toeboard, hands on the steering wheel at the 10 o'clock and 2 o'clock positions, the head and body in a relaxed driving posture. Use a steel tape to measure the circumference of the left forearm in a plane perpendicular to the long axis of the forearm at the forearm upper landmark. (The forearm upper landmark is a point marked on the lateral surface of the forearm at the estimated maximum circumference.)



	N	Minimum	Maximum	Mean	Std Dev		CV %
Small Female	25	19.7 (7.8)	23.8 (9.4)	21.5 (8.5)	1.10 (cm) (0.43) (in)		5.11
Mid-Sized Male	25	25.5 (10.0)	30.4 (12.0)	27.5 (10.8)	1.29 (cm) (0.51) (in)		4.70
Large Male	25	27.5 (10.8)	33.2 (13.1)	29.6 (11.6)	1.40 (cm) (0.55) (in)		4.74

FOREARM CIRCUMFERENCE (lower)

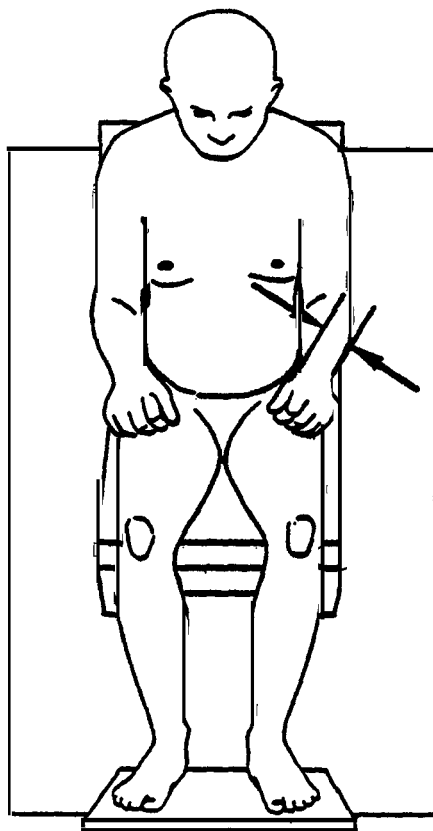
The subject sits in the contoured hardseat, feet placed firmly on the toeboard, hands on the steering wheel at the 10 o'clock and 2 o'clock positions, the head and body in a relaxed driving posture. Use a steel tape to measure the circumference of the left forearm in a plane perpendicular to the long axis of the lower arm at the forearm lower landmark. (The forearm lower landmark is a point marked on the lateral surface of the forearm between the estimated maximum circumference and the wrist.)



	N	Minimum	Maximum	Mean	Std Dev	CV %
Small Female	25	13.9 (5.5)	18.0 (7.1)	15.8 (6.2)	1.09 (cm) (0.43) (in)	6.92
Mid-Sized Male	25	16.0 (6.3)	20.6 (8.1)	18.3 (7.2)	1.17 (cm) (0.46) (in)	6.43
Large Male	25	17.0 (6.7)	23.5 (9.3)	20.3 (8.0)	1.55 (cm) (0.61) (in)	7.63

WRIST BREADTH (condyles)

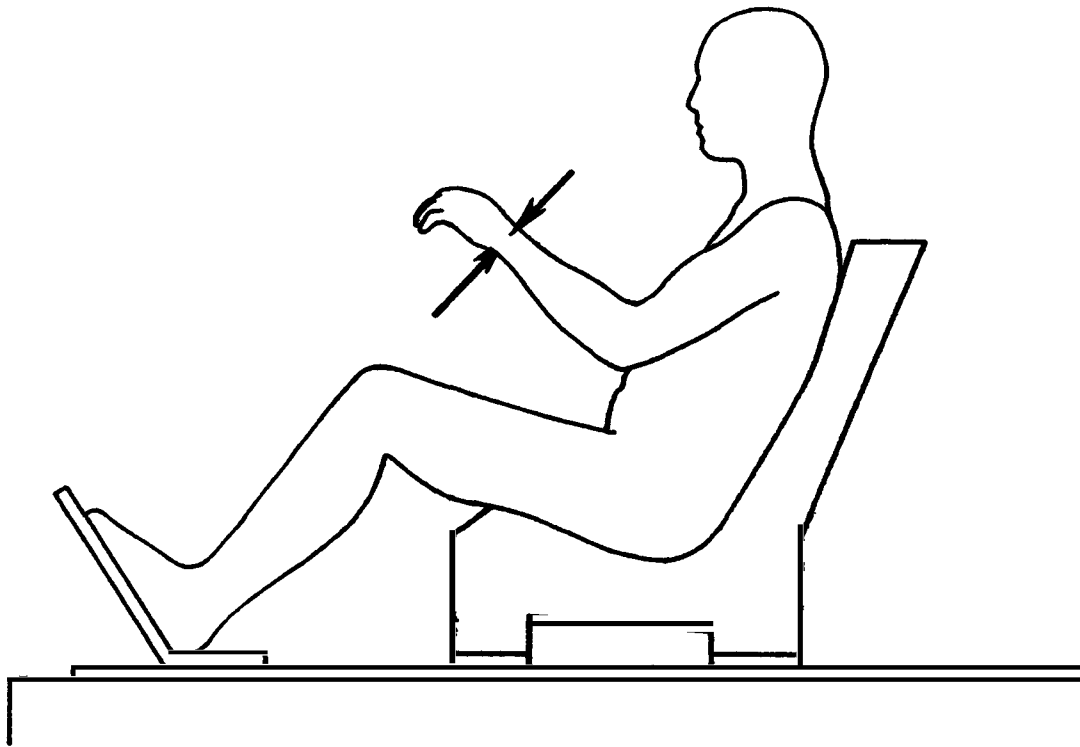
The subject sits in the contoured hardseat, feet placed firmly on the toeboard, hands on the steering wheel at the 10 o'clock and 2 o'clock positions, the head and body in a relaxed driving posture. Use an anthropometer to measure the breadth of the left wrist from the stylium landmark to the ulnar styloid landmark. (The stylium landmark is a point on the surface of the skin obtained by palpating the most distal margin of the styloid process of the radius. The ulnar styloid landmark is a point on the surface of the skin obtained by palpating the most distal margin of the styloid process of the ulna.)



	N	Minimum	Maximum	Mean	Std Dev	CV %
Small Female	25	4.1 (1.6)	5.2 (2.0)	4.7 (1.9)	0.24 (cm) (0.09) (in)	5.06
Mid-Sized Male	25	5.4 (2.1)	6.7 (2.6)	5.9 (2.3)	0.34 (cm) (0.13) (in)	5.69
Large Male	25	5.8 (2.3)	6.6 (2.6)	6.2 (2.4)	0.21 (cm) (0.08) (in)	3.48

WRIST DEPTH (condyles)

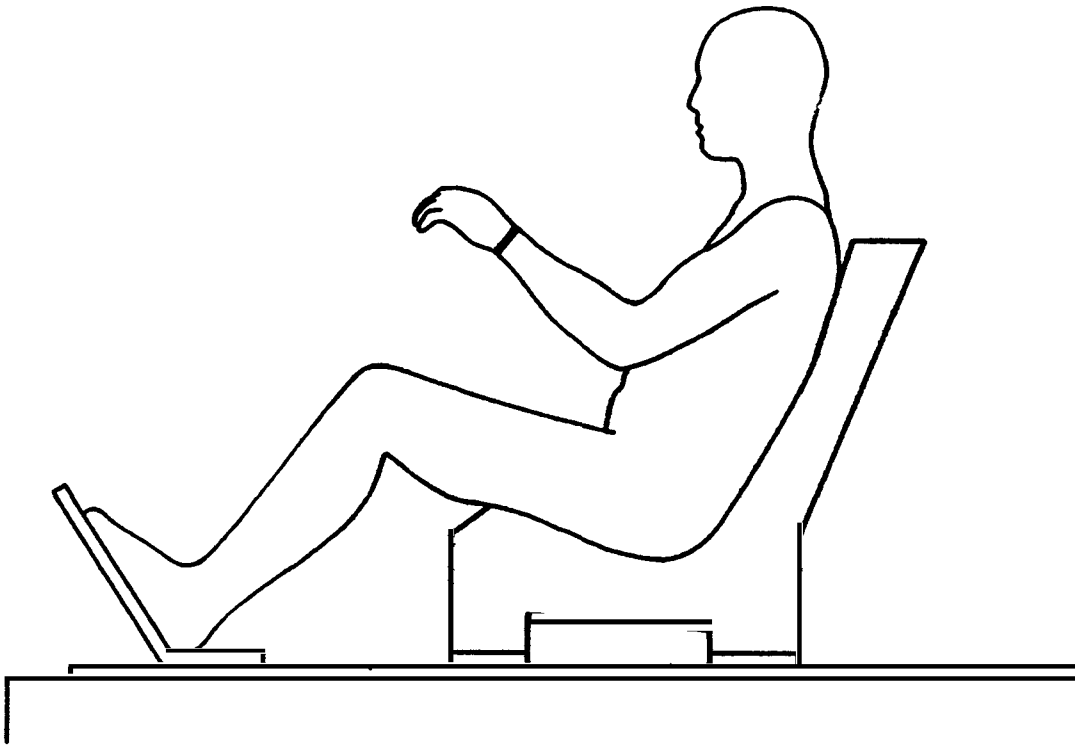
The subject sits in the contoured hardseat, feet placed firmly on the toeboard, hands on the steering wheel at the 10 o'clock and 2 o'clock positions, the head and body in a relaxed driving posture. Use an anthropometer held perpendicular to the long axis of the forearm to measure the depth of the wrist at the level of the condyles.



	N	Minimum	Maximum	Mean	Std Dev	CV %
Small Female	25	3.0 (1.2)	3.9 (1.5)	3.4 (1.3)	0.22 (cm) (0.09) (in)	6.47
Mid-Sized Male	25	3.8 (1.5)	5.1 (2.0)	4.1 (1.6)	0.27 (cm) (0.11) (in)	6.46
Large Male	25	4.2 (1.7)	5.3 (2.1)	4.5 (1.8)	0.25 (cm) (0.10) (in)	5.63

WRIST CIRCUMFERENCE (condyles)

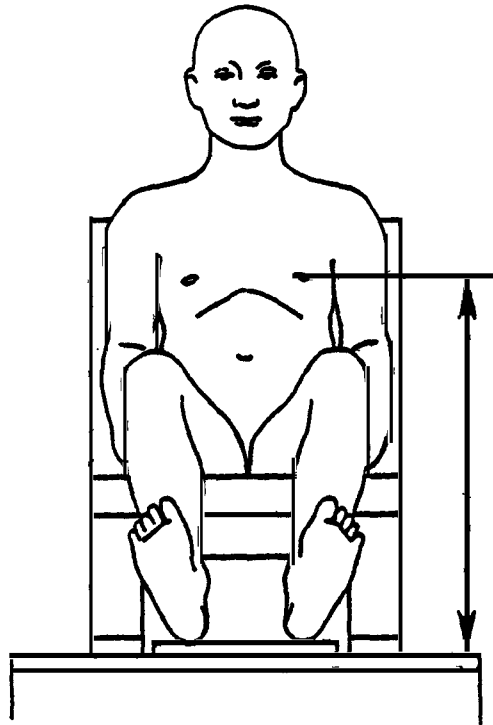
The subject sits in the contoured hardseat, feet placed firmly on the toeboard, hands on the steering wheel at the 10 o'clock and 2 o'clock positions, the head and body in a relaxed driving posture. Use a steel tape to measure the circumference of the left wrist across the ulnar styloid landmark and the styliion landmark. (The ulnar styloid landmark is a point on the surface of the skin obtained by palpating the most distal margin of the styloid process of the ulna. The styliion landmark is a point on the surface of the skin obtained by palpating the most distal margin of the styloid process of the radius.)



	N	Minimum	Maximum	Mean	Std Dev	CV %
Small Female	24	13.0 (5.1)	15.1 (5.9)	14.2 (5.6)	0.53 (cm) (0.21) (in)	3.71
Mid-Sized Male	25	15.7 (6.2)	18.3 (7.2)	16.9 (6.6)	0.64 (cm) (0.25) (in)	3.80
Large Male	25	17.2 (6.8)	19.0 (7.5)	18.1 (7.1)	0.48 (cm) (0.19) (in)	2.67

CHEST HEIGHT (nipple)

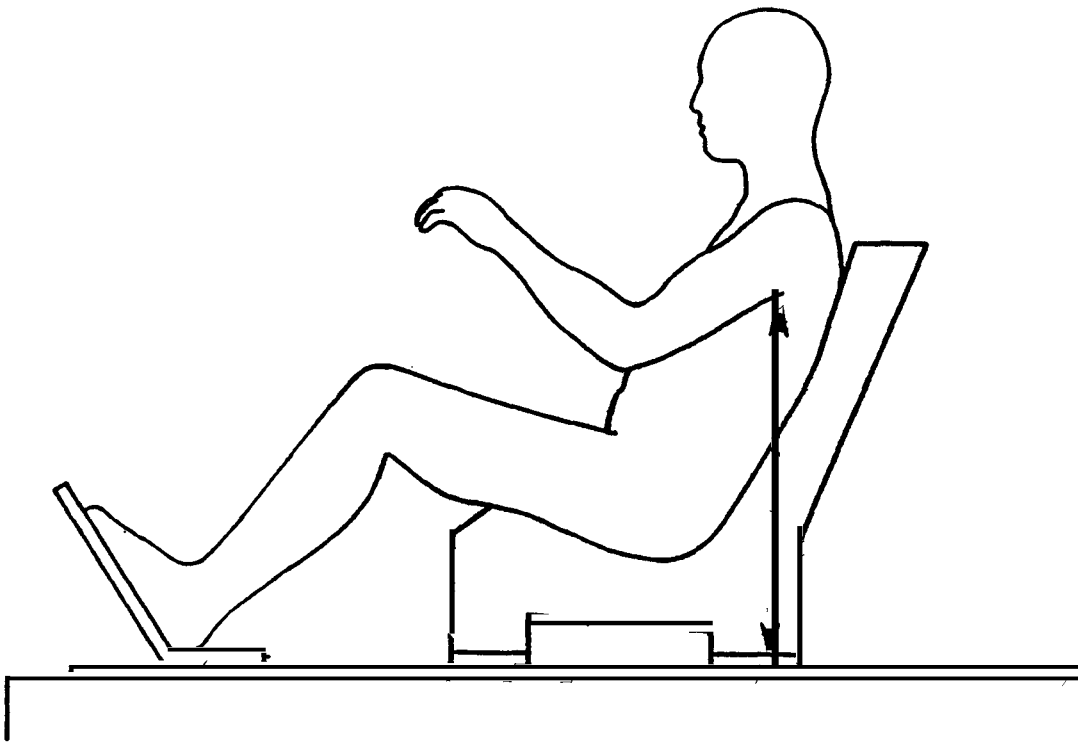
The subject sits in the contoured hardseat, feet placed firmly on the toeboard, head and body in a relaxed driving posture with the steering wheel removed and hands dropped to the sides of the seat. Use an anthropometer to measure the vertical distance from the reference surface to the left nipple landmark during mid-inhalation. (The nipple landmark is a point on the surface of the skin at the center of the pigmented projection on the anterior surface of the mammary gland.)



	N	Minimum	Maximum	Mean	Std Dev	CV %
Small Female	25	45.8 (18.0)	55.5 (21.9)	51.7 (20.4)	2.16 (cm) (0.85) (in)	4.18
Mid-Sized Male	25	52.1 (20.5)	60.4 (23.8)	55.4 (21.8)	2.09 (cm) (0.82) (in)	3.77
Large Male	25	52.8 (20.8)	61.1 (24.1)	57.1 (22.5)	2.44 (cm) (0.96) (in)	4.27

CHEST HEIGHT (posterior scye)

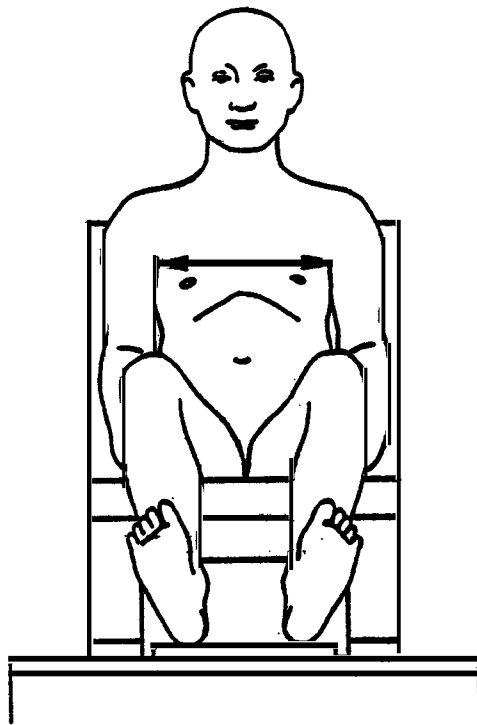
The subject sits in the contoured hardseat, feet placed firmly on the toeboard, hands on the steering wheel at the 10 o'clock and 2 o'clock positions, the head and body in a relaxed driving posture. Use an anthropometer to measure the vertical distance from the reference surface to the left scye posterior landmark. (The scye posterior landmark is a point on the surface of the skin at the posterior-superior margin of the skin furrow formed by the juncture of the upper arm and torso, i.e., the posterior axillary fold.)



	N	Minimum	Maximum	Mean	Std Dev	CV %
Small Female	25	52.2 (20.6)	57.5 (22.6)	55.1 (21.7)	1.49 (cm) (0.59) (in)	2.71
Mid-Sized Male	25	54.4 (21.4)	59.9 (23.6)	57.0 (22.4)	1.63 (cm) (0.64) (in)	2.87
Large Male	25	54.7 (21.5)	61.3 (24.1)	57.9 (22.8)	1.95 (cm) (0.77) (in)	3.36

CHEST BREADTH (axilla)

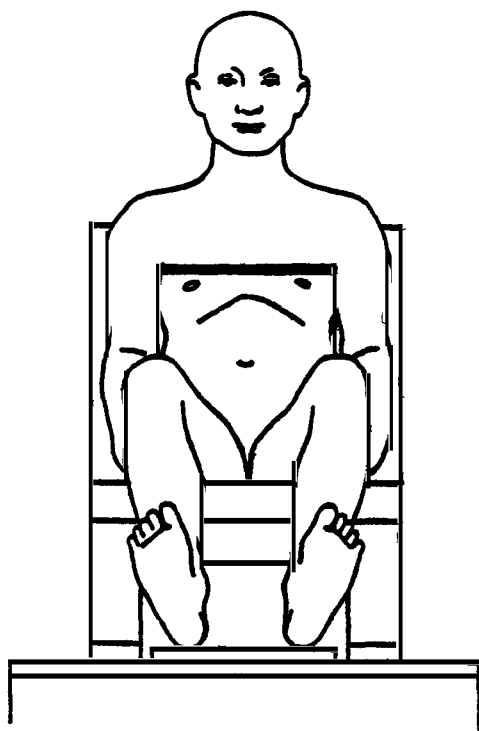
The subject sits in the contoured hardseat, feet placed firmly on the toeboard, head and body in a relaxed driving posture with the steering wheel removed and hands dropped to the sides of the seat. Use an anthropometer held horizontally to measure the distance between the right and left scye anterior landmarks. The subject raises arms slightly while the anthropometer is positioned, then lowers arms to the sides just before the measurement is taken. (The scye anterior landmark is a point on the surface of the skin at the anterior-superior margin of the skin furrow formed by the juncture of the upper arm and torso, i.e., the anterior axillary fold.)



	N	Minimum	Maximum	Mean	Std Dev	CV %
Small Female	25	23.8 (9.4)	29.4 (11.6)	26.0 (10.2)	1.19 (cm) (0.47) (in)	4.59
Mid-Sized Male	25	27.8 (10.9)	32.8 (12.9)	30.4 (12.0)	1.15 (cm) (0.45) (in)	3.78
Large Male	25	28.5 (11.2)	36.3 (14.3)	32.3 (12.7)	1.80 (cm) (0.71) (in)	5.56

CHEST CIRCUMFERENCE (axilla)

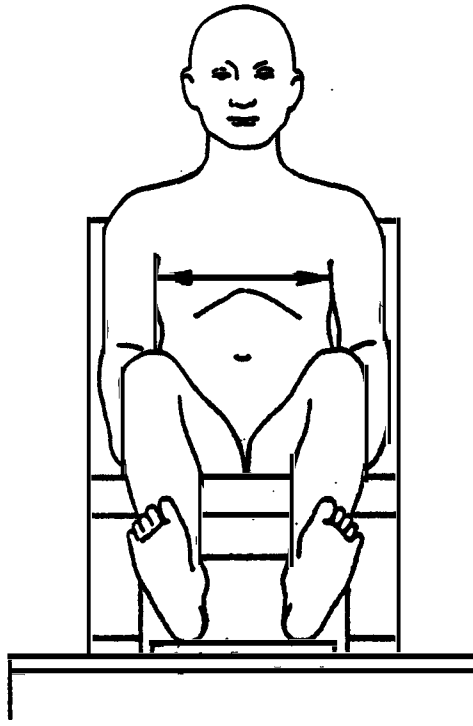
The subject sits in the contoured hardseat, feet placed firmly on the toeboard, head and body in a relaxed driving posture with the steering wheel removed and hands dropped to the sides of the seat. Use a steel tape to measure the circumference of the chest in a plane perpendicular to the long axis of the torso through the left and right axillary folds during mid-inhalation. The subject leans forward in the seat and raises arms slightly while the tape is positioned, then leans back and lowers arms to the sides just before the measurement is taken. (The axillary folds are formed at the junctures of the upper arms and torso.)



	N	Minimum	Maximum	Mean	Std Dev	CV %
Small Female	25	75.0 (29.5)	89.0 (35.0)	82.4 (32.4)	3.94 (cm) (1.55) (in)	4.79
Mid-Sized Male	25	99.3 (39.1)	111.3 (43.8)	103.9 (40.9)	3.23 (cm) (1.27) (in)	3.11
Large Male	25	107.1 (42.2)	125.4 (49.4)	117.1 (46.1)	5.48 (cm) (2.16) (in)	4.68

CHEST BREADTH (nipple)

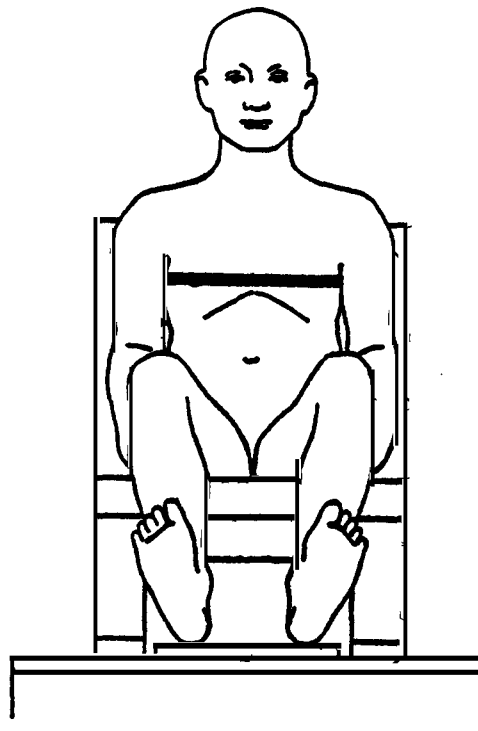
The subject sits in the contoured hardseat feet placed firmly on the toeboard, head and body in a relaxed driving posture with the steering wheel removed and hands dropped to the sides of the seat. Use an anthropometer held horizontally to measure the breadth of the chest at the level of the nipple landmarks. The subject raises arms slightly while the anthropometer is positioned, then lowers arms to the sides just before the measurement is taken. (The nipple landmark is a point marked on the surface of the skin at the center of the pigmented projection on the anterior surface of the mammary gland.)



	N	Minimum	Maximum	Mean	Std Dev	CV %
Small Female	25	25.2 (9.9)	30.8 (12.1)	27.6 (10.9)	1.50 (cm) (0.59) (in)	5.45
Mid-Sized Male	25	32.5 (12.8)	38.3 (15.1)	34.9 (13.7)	1.63 (cm) (0.64) (in)	4.67
Large Male	25	34.0 (13.4)	44.4 (17.5)	38.4 (15.1)	2.47 (cm) (0.97) (in)	6.44

CHEST CIRCUMFERENCE (nipple)

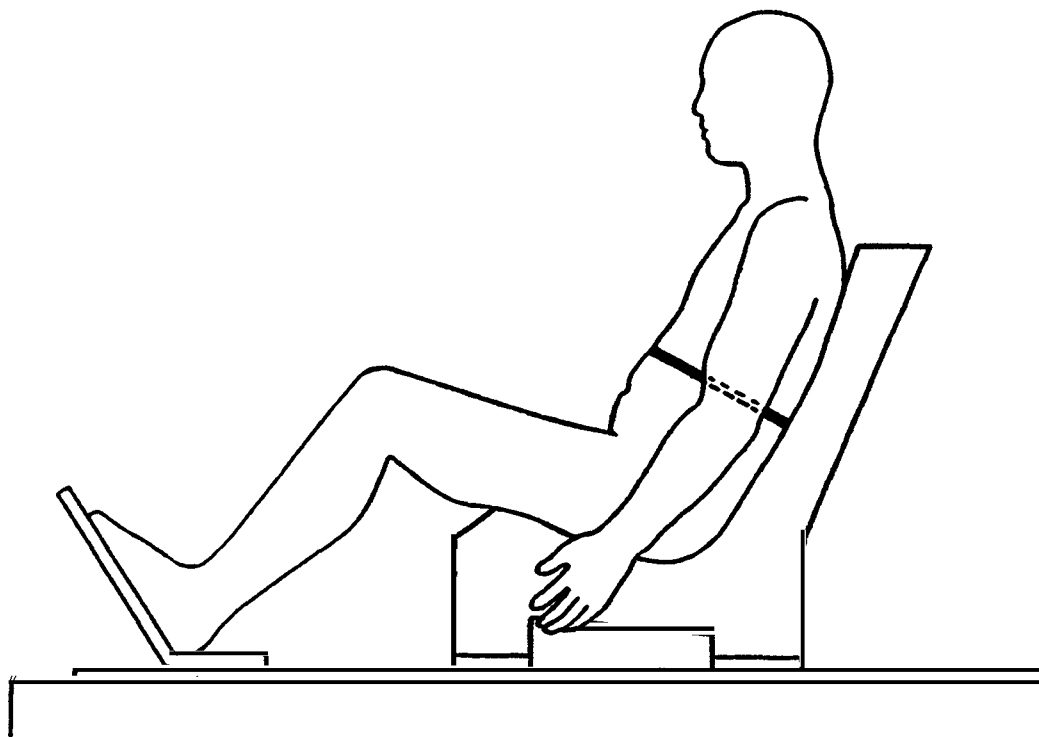
The subject sits in the contoured hardseat, feet placed firmly on the toeboard, head and body in a relaxed driving posture with the steering wheel removed and hands dropped to the sides of the seat. Use a steel tape to measure the circumference of the chest in a plane perpendicular to the long axis of the torso at the level of the nipple landmarks during mid-inhalation. The subject leans forward in the seat and raises arms slightly while the tape is positioned, then leans back and lowers arms to the sides just before the measurement is taken. (The nipple landmark is a point on the surface of the skin at the center of the pigmented projection on the anterior surface of the mammary gland.)



	N	Minimum	Maximum	Mean	Std Dev	CV %
Small Female	25	76.4 (30.1)	92.6 (36.5)	83.3 (32.8)	3.87 (cm) (1.52) (in)	4.65
Mid-Sized Male	25	95.4 (37.6)	105.5 (41.5)	101.0 (39.7)	3.12 (cm) (1.23) (in)	3.10
Large Male	25	105.4 (41.5)	128.5 (50.6)	115.9 (45.6)	5.28 (cm) (2.08) (in)	4.56

CHEST CIRCUMFERENCE (tenth rib)

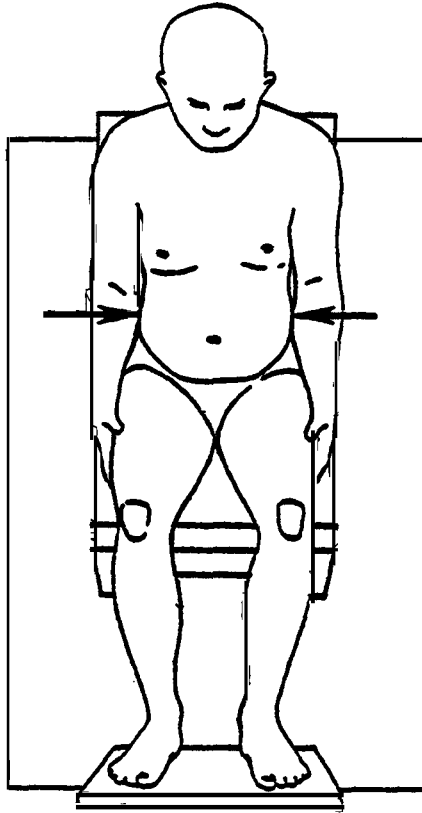
The subject sits in the contoured hardseat, feet placed firmly on the toeboard, head and body in a relaxed driving posture with the steering wheel removed and hands dropped to the sides of the seat. Use a steel tape to measure the circumference of the chest in a plane perpendicular to the long axis of the torso at the level of the tenth rib landmark during mid-inhalation. The subject leans forward in the seat and raises arms slightly while the tape is positioned, then leans back and lowers arms to the sides just before the measurement is taken. (The tenth rib landmark is a point on the surface of the skin obtained by palpating the most inferior margin of the tenth rib.)



	N	Minimum	Maximum	Mean	Std Dev	CV %
Small Female	25	60.1 (23.7)	80.2 (31.6)	68.9 (27.1)	5.33 (cm) (2.10) (in)	7.75
Mid-Sized Male	25	80.2 (31.6)	99.3 (39.1)	90.9 (35.8)	5.19 (cm) (2.04) (in)	5.71
Large Male	25	92.5 (36.4)	120.8 (47.6)	106.5 (41.9)	6.90 (cm) (2.72) (in)	6.47

WAIST BREADTH (umbilicus)

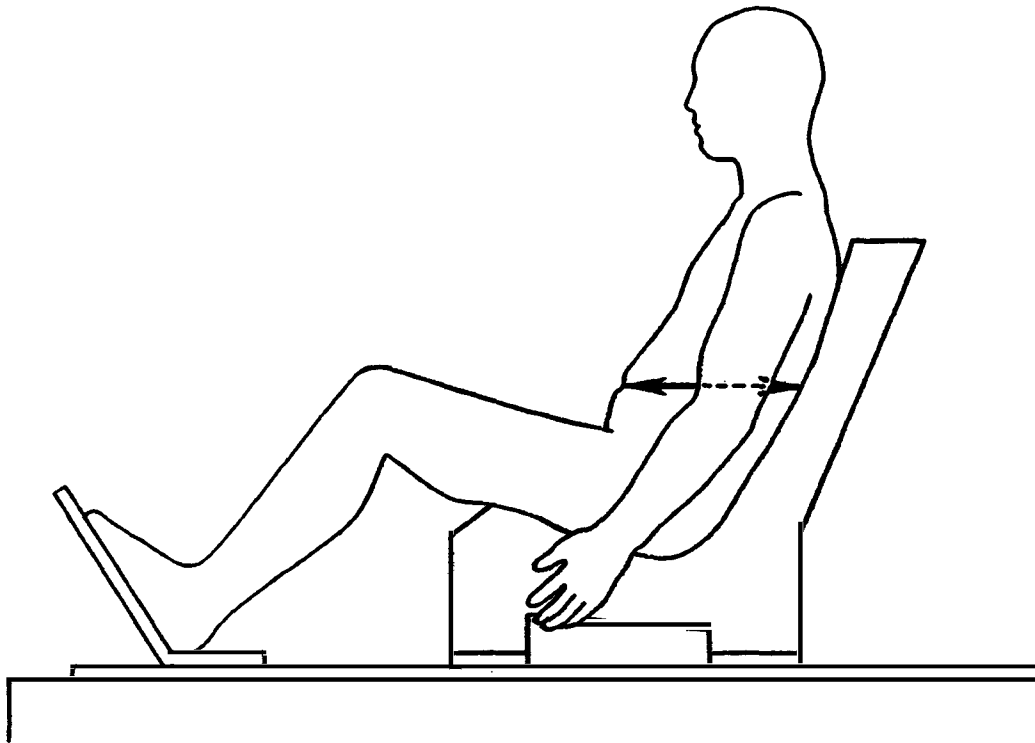
The subject sits in the contoured hardseat, feet placed firmly on the toeboard, head and body in a relaxed driving posture with the steering wheel removed and hands dropped to the sides of the seat. Use an anthropometer held horizontally to measure the breadth of the waist at the level of the umbilicus landmark. (The umbilicus landmark is a point on the surface of the skin at the center of the navel or "belly button.")



	N	Minimum	Maximum	Mean	Std Dev	CV %
Small Female	25	21.0 (8.3)	29.1 (11.5)	24.7 (9.7)	2.11 (cm) (0.83) (in)	8.55
Mid-Sized Male	25	27.7 (10.9)	35.1 (13.8)	31.4 (12.3)	2.12 (cm) (0.84) (in)	6.77
Large Male	25	32.8 (12.9)	40.2 (15.8)	36.1 (14.2)	2.02 (cm) (0.79) (in)	5.60

WAIST DEPTH (umbilicus)

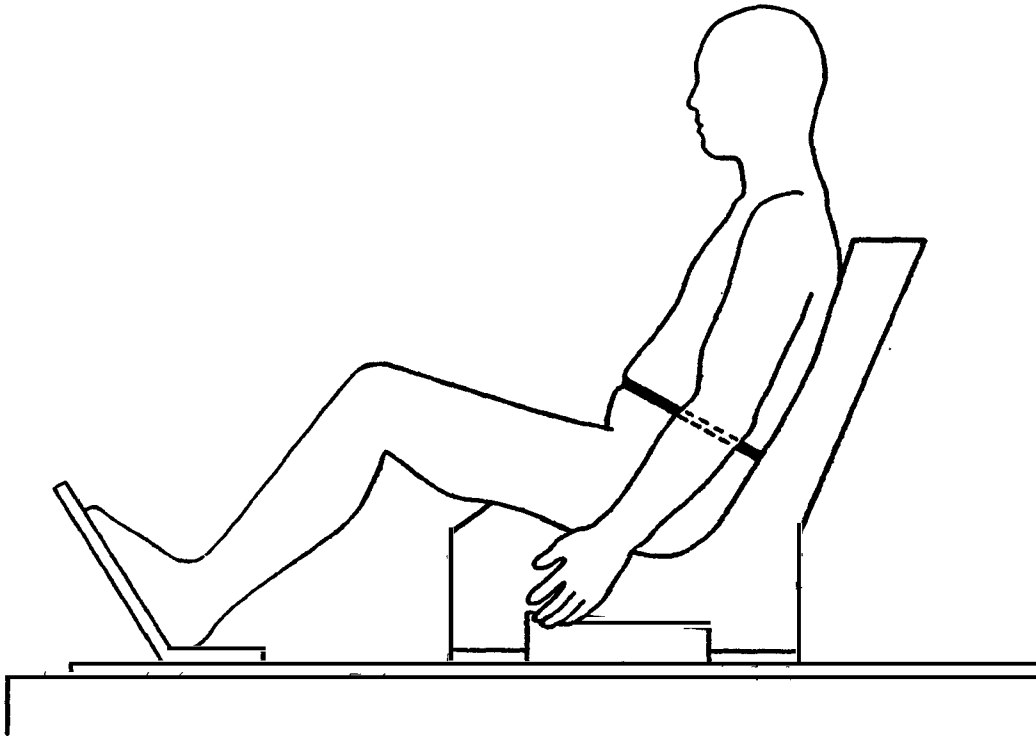
The subject sits in the contoured hardseat, feet placed firmly on the toeboard, head and body in a relaxed driving posture with the steering wheel removed and hands dropped to the sides of the seat. Use an anthropometer equipped with special blades, to measure the horizontal depth of the waist through the seat back opening at the level of the umbilicus landmark. (The umbilicus landmark is a point on the surface of the skin at the center of the navel or "belly button.")



	N	Minimum	Maximum	Mean	Std Dev	CV %
Small Female	25	16.1 (6.3)	23.0 (9.1)	18.8 (7.4)	1.52 (cm) (0.60) (in)	8.08
Mid-Sized Male	25	20.0 (7.9)	27.7 (10.9)	24.4 (9.6)	1.84 (cm) (0.73) (in)	7.55
Large Male	25	21.7 (8.5)	37.0 (14.6)	30.1 (11.9)	3.55 (cm) (1.40) (in)	11.77

WAIST CIRCUMFERENCE (umbilicus)

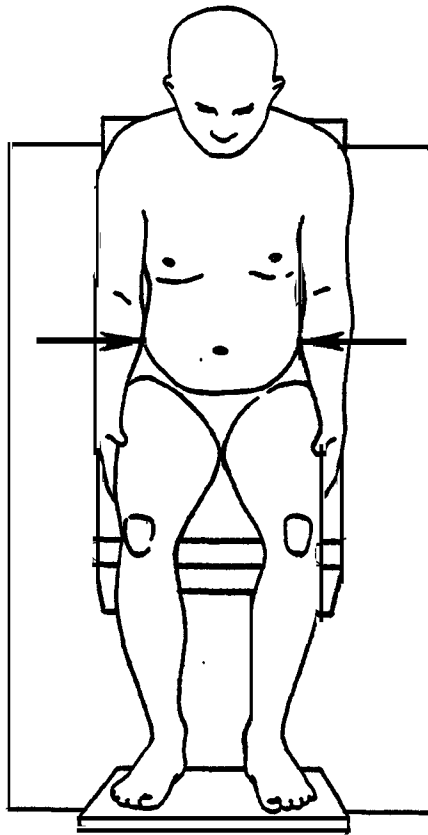
The subject sits in the contoured hardseat, feet placed firmly on the toeboard, head and body in a relaxed driving posture with the steering wheel removed and hands dropped to the sides of the seat. Use a steel tape to measure the circumference of the waist in a plane perpendicular to the long axis of the torso at the umbilicus landmark. The subject leans forward in the seat and raises arms slightly while the tape is positioned, then leans back and lowers arms to the sides just before the measurement is taken. (The umbilicus landmark is a point on the surface of the skin at the center of the navel or "belly button.")



	N	Minimum	Maximum	Mean	Std Dev	CV %
Small Female	25	61.1 (24.1)	84.4 (33.2)	70.8 (27.9)	5.31 (cm) (2.09) (in)	7.50
Mid-Sized Male	25	80.0 (31.5)	97.1 (38.2)	90.4 (35.6)	5.12 (cm) (2.02) (in)	5.66
Large Male	25	94.0 (37.0)	121.6 (47.9)	107.5 (42.3)	6.83 (cm) (2.69) (in)	6.35

ABDOMINAL BREADTH (maximum)

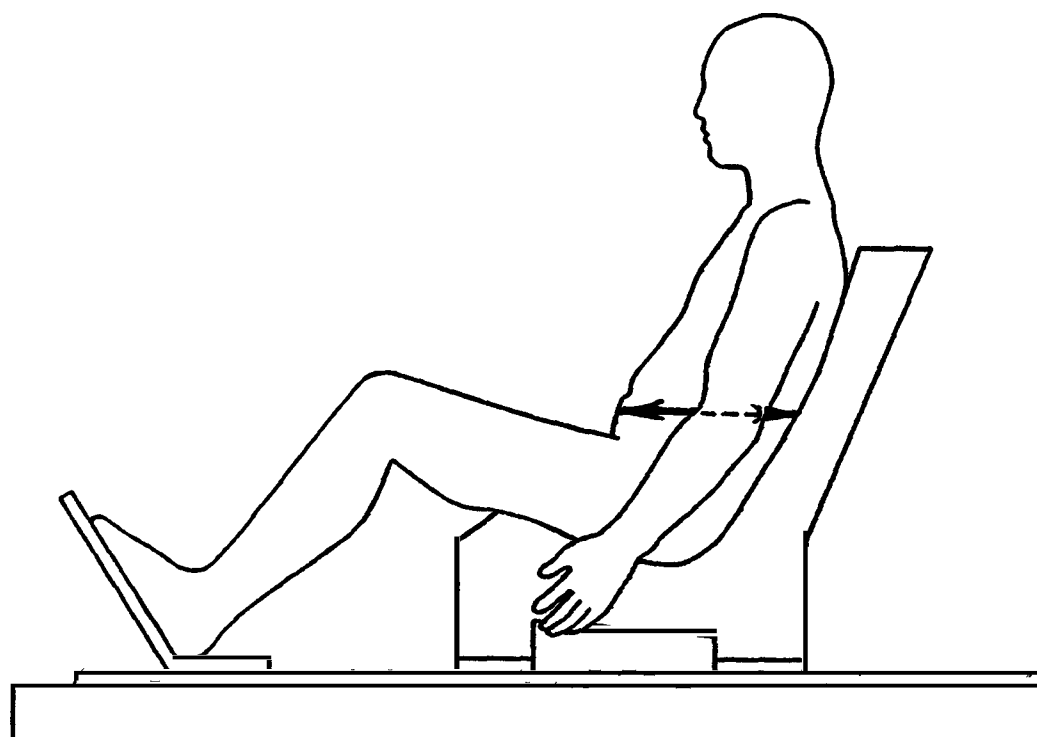
The subject sits in the contoured hardseat, feet placed firmly on the toeboard, head and body in a relaxed driving posture with the steering wheel removed and hands dropped to the sides of the seat. Use an anthropometer held horizontally to measure the maximum breadth of the abdomen.



	N	Minimum	Maximum	Mean	Std Dev	CV %
Small Female	25	24.0 (9.4)	33.3 (13.1)	27.9 (11.0)	2.20 (cm) (0.87) (in)	7.90
Mid-Sized Male	25	29.4 (11.6)	35.9 (14.1)	32.5 (12.8)	1.79 (cm) (0.71) (in)	5.51
Large Male	25	35.8 (14.1)	42.3 (16.7)	38.4 (15.1)	1.78 (cm) (0.70) (in)	4.63

ABDOMINAL DEPTH (maximum)

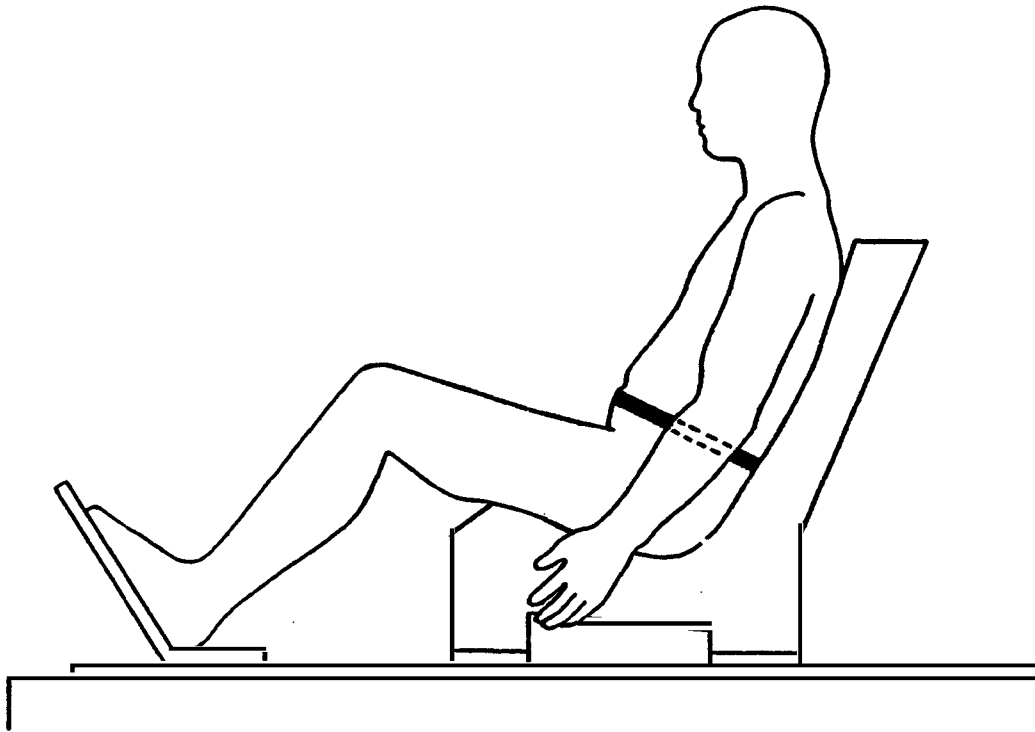
The subject sits in the contoured hardseat, feet placed firmly on the toeboard, head and body in a relaxed driving posture with the steering wheel removed and hands dropped to the sides of the seat. Use an anthropometer equipped with special blades to measure the horizontal depth of the abdomen through the seat back opening at the level of the maximum abdominal protrusion landmark. (The maximum abdominal protrusion landmark is a point on the surface of the skin in the anterior midline at the level of the maximum protrusion of the abdomen.)



	N	Minimum	Maximum	Mean	Std Dev	CV %
Small Female	25	18.0 (7.1)	24.4 (9.6)	21.0 (8.3)	1.57 (cm) (0.62) (in)	7.51
Mid-Sized Male	25	22.8 (9.0)	30.3 (11.9)	26.9 (10.6)	1.96 (cm) (0.77) (in)	7.27
Large Male	25	27.1 (10.7)	37.9 (14.9)	31.6 (12.4)	2.96 (cm) (1.17) (in)	9.36

ABDOMINAL CIRCUMFERENCE (maximum)

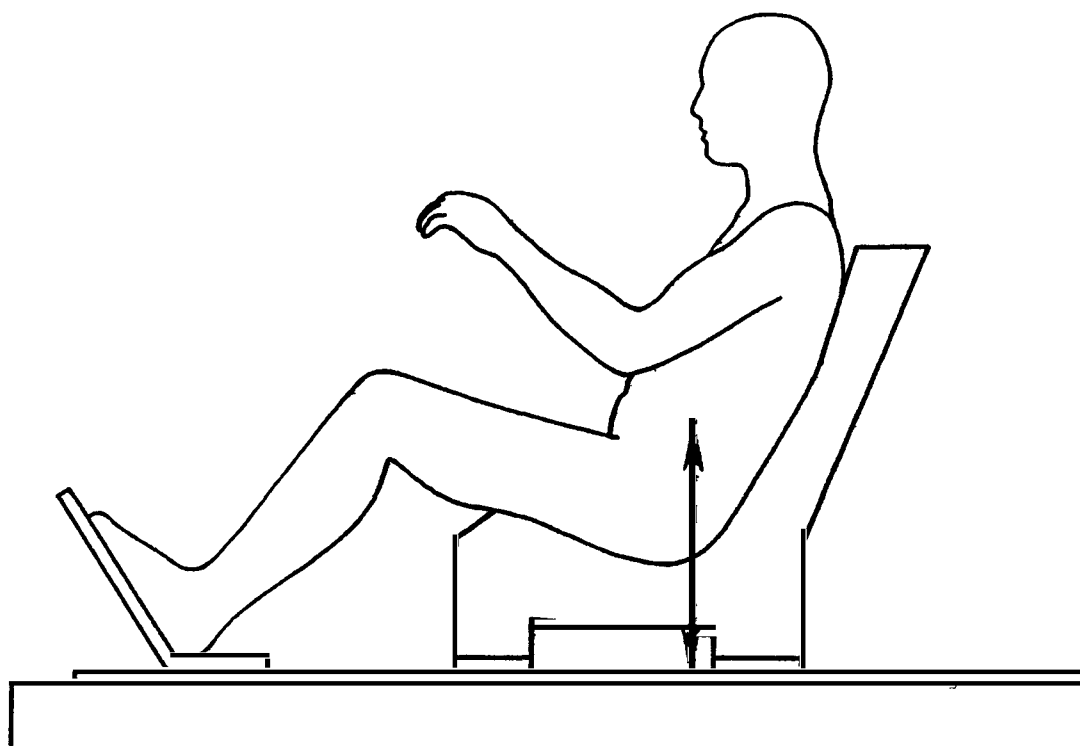
The subject sits in the contoured hardseat, feet placed firmly on the toeboard, head and body in a relaxed driving posture with the steering wheel removed and hands dropped to the sides of the seat. Use a steel tape to measure the circumference of the abdomen in a plane perpendicular to the long axis of the torso at the level of the maximum abdominal protrusion landmark. The subject leans forward in the seat and raises arms slightly while the tape is positioned, then leans back and lowers arms to the sides just before the measurement is taken. (The maximum abdominal protrusion landmark is a point on the surface of the skin in the anterior midline at the level of the maximum protrusion of the abdomen.)



	N	Minimum	Maximum	Mean	Std Dev		CV %
Small Female	25	67.5 (26.6)	89.2 (35.1)	75.4 (29.7)	5.00 (1.97)	(cm) (in)	6.63
Mid-Sized Male	25	80.2 (31.6)	99.2 (39.1)	91.3 (35.9)	5.32 (2.09)	(cm) (in)	5.82
Large Male	25	99.2 (39.1)	121.7 (47.9)	108.2 (42.6)	6.36 (2.50)	(cm) (in)	5.88

ILIOCRISTALE HEIGHT

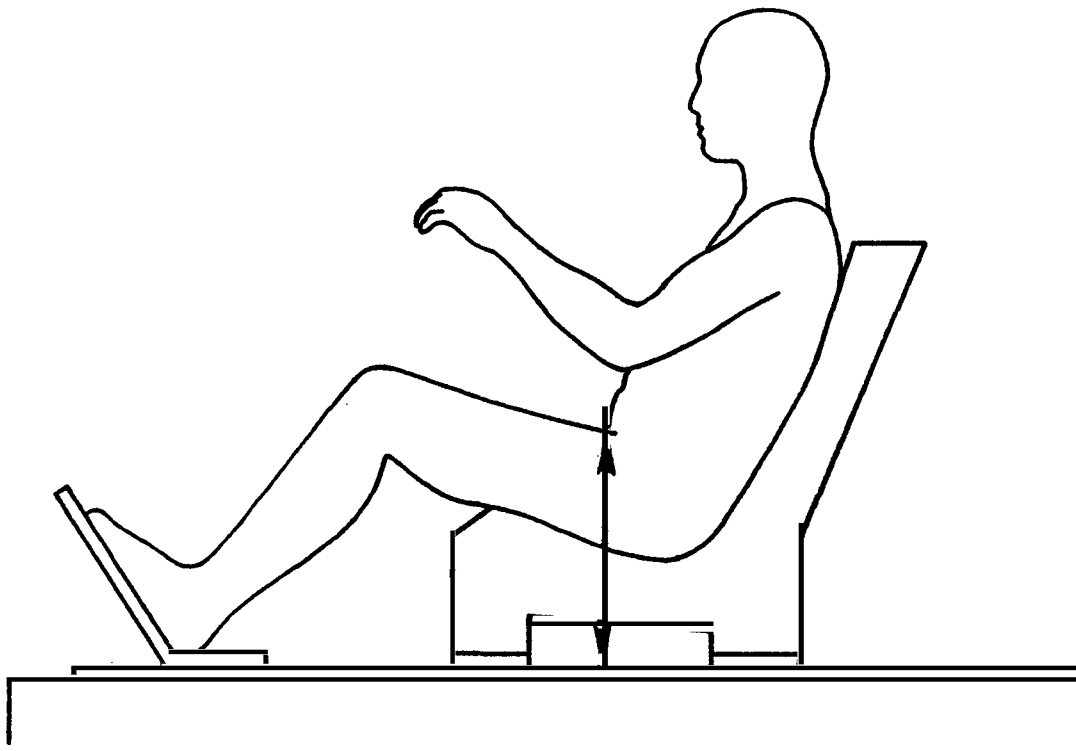
The subject sits in the contoured hardseat, feet placed firmly on the toeboard, hands on the steering wheel at the 10 o'clock and 2 o'clock positions, the head and body in a relaxed driving posture. Use an anthropometer to measure the vertical distance from the reference surface to the left iliocristale landmark. (The iliocristale landmark is a point on the surface of the skin obtained by palpating the most superior margin of the iliac crest.)



	N	Minimum	Maximum	Mean	Std Dev	CV %
Small Female	25	33.4 (13.2)	37.8 (14.9)	35.2 (13.9)	1.15 (cm) (0.45) (in)	3.25
Mid-Sized Male	25	34.4 (13.6)	37.3 (14.7)	35.7 (14.1)	0.76 (cm) (0.30) (in)	2.12
Large Male	25	33.4 (13.1)	39.5 (15.6)	35.4 (13.9)	1.51 (cm) (0.59) (in)	4.25

THIGH-ABDOMINAL JUNCTION HEIGHT

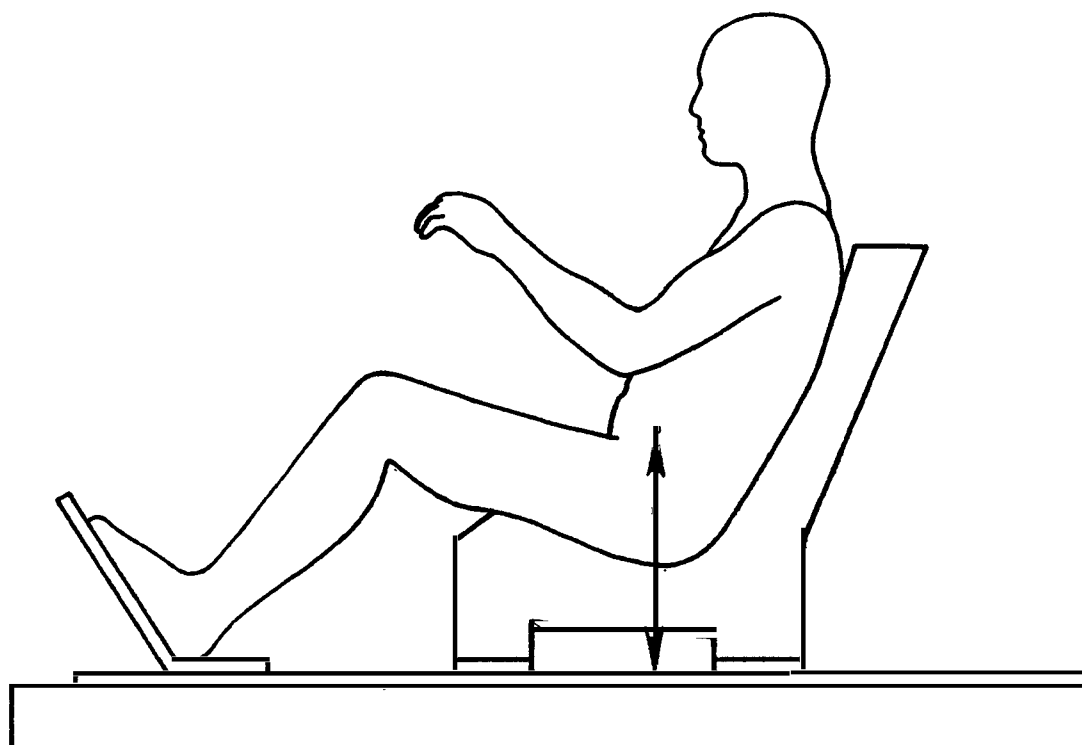
The subject sits in the contoured hardseat, feet placed firmly on the toeboard, hands on the steering wheel at the 10 o'clock and 2 o'clock positions, the head and body in a relaxed driving posture. Use an anthropometer to measure the vertical distance from the reference surface to the left thigh-abdominal junction landmark. (The thigh-abdominal junction landmark is a point on the surface of the skin at the crease formed by the juncture of the thigh and abdomen at approximately the midline of the thigh.)



	N	Minimum	Maximum	Mean	Std Dev	CV %
Small Female	25	30.7 (12.1)	34.5 (13.6)	32.7 (12.9)	0.87 (cm) (0.34) (in)	2.65
Mid-Sized Male	25	33.1 (13.0)	36.2 (14.3)	34.5 (13.6)	0.88 (cm) (0.35) (in)	2.54
Large Male	25	32.8 (12.9)	36.8 (14.5)	34.5 (13.6)	1.18 (cm) (0.46) (in)	3.42

ANTERIOR-SUPERIOR ILIAC SPINE HEIGHT

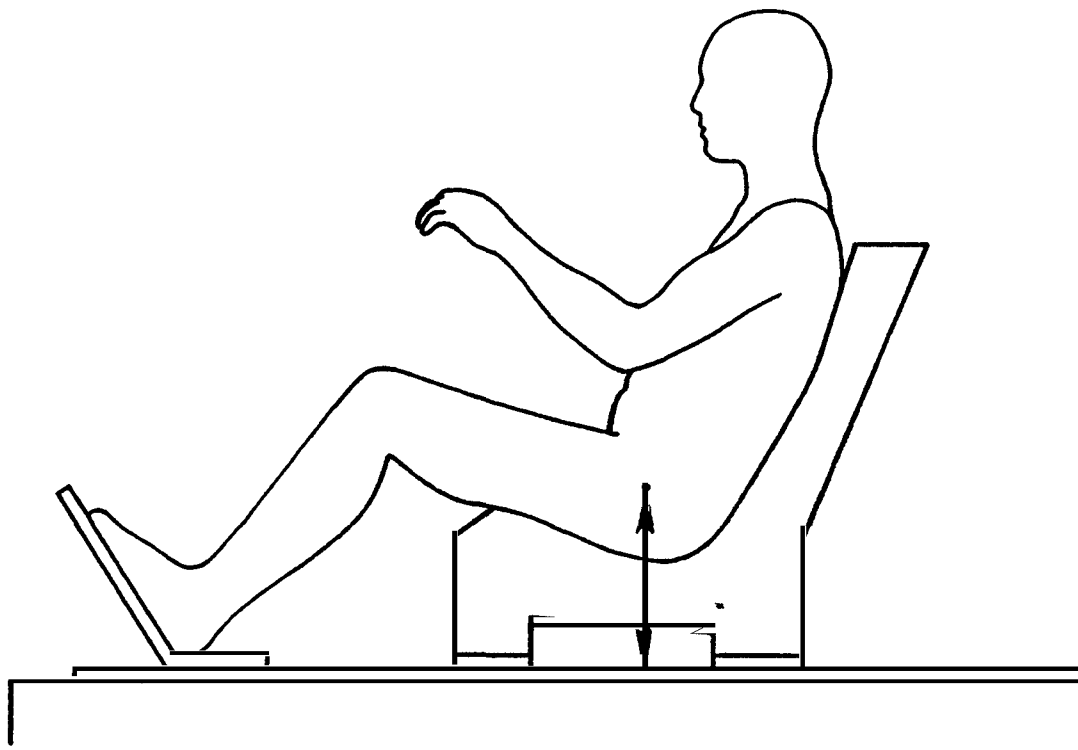
The subject sits in the contoured hardseat, feet placed firmly on the toeboard, hands on the steering wheel at the 10 o'clock and 2 o'clock positions, the head and body in a relaxed driving posture. Use an anthropometer to measure the vertical distance from the reference surface to the left anterior-superior iliac spine landmark. (The anterior-superior iliac spine landmark is a point on the surface of the skin obtained by palpating the anterior-superior spine of the iliac crest of the pelvis.)



	N	Minimum	Maximum	Mean	Std Dev	CV %
Small Female	25	32.3 (12.7)	36.6 (14.4)	34.2 (13.5)	0.94 (cm) (0.37) (in)	2.74
Mid-Sized Male	25	32.9 (13.0)	36.7 (14.4)	34.7 (13.7)	0.87 (cm) (0.34) (in)	2.50
Large Male	25	33.2 (13.1)	37.2 (14.6)	34.9 (13.7)	1.07 (cm) (0.42) (in)	3.06

TROCHANTERION HEIGHT

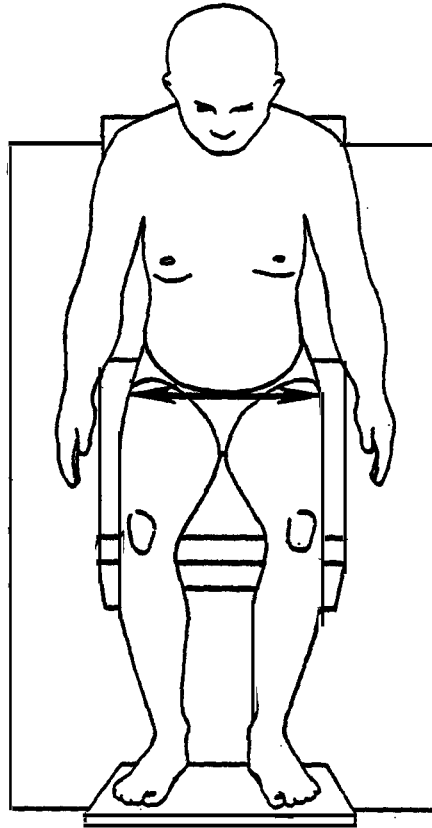
The subject sits in the contoured hardseat, feet placed firmly on the toeboard, hands on the steering wheel at the 10 o'clock and 2 o'clock positions, the head and body in a relaxed driving posture. Use an anthropometer to measure the vertical distance from the reference surface to the left trochanterion landmark. (The trochanterion landmark is a point on the surface of the skin obtained by palpating the most lateral margin of the greater trochanter of the femur.)



	N	Minimum	Maximum	Mean	Std Dev	CV %
Small Female	25	24.1 (9.5)	26.3 (10.4)	24.8 (9.8)	0.65 (cm) (0.26) (in)	2.62
Mid-Sized Male	25	27.6 (10.9)	30.9 (12.2)	29.2 (11.5)	0.97 (cm) (0.38) (in)	3.32
Large Male	25	26.4 (10.4)	30.6 (12.0)	28.4 (11.2)	1.11 (cm) (0.44) (in)	3.92

HIP BREADTH (maximum)

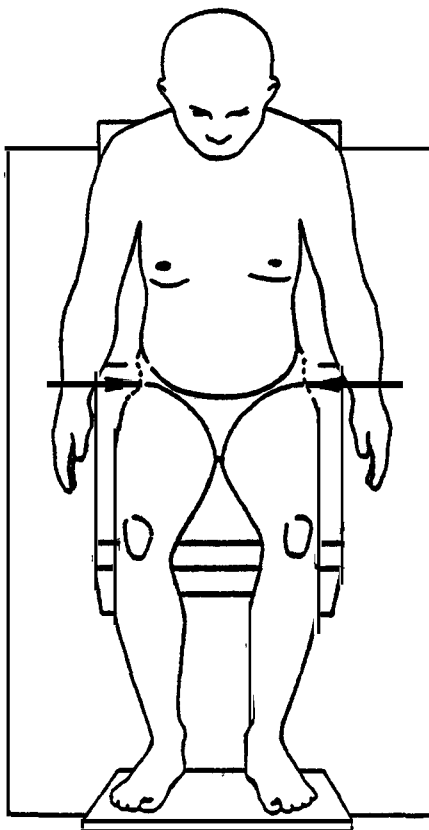
The subject sits in the contoured hardseat, feet placed firmly on the toeboard, head and body in a relaxed driving posture with the steering wheel removed and hands dropped to the sides of the seat. Use an anthropometer held horizontally to measure the maximum breadth of the hips.



	N	Minimum	Maximum	Mean	Std Dev	CV %
Small Female	25	33.5 (13.2)	39.5 (15.6)	35.6 (14.0)	1.76 (cm) (0.69) (in)	4.93
Mid-Sized Male	25	34.6 (13.6)	41.0 (16.1)	38.5 (15.1)	1.83 (cm) (0.72) (in)	4.75
Large Male	25	40.7 (16.0)	48.5 (19.1)	43.9 (17.3)	2.19 (cm) (0.86) (in)	4.99

BITROCHANTER BREADTH

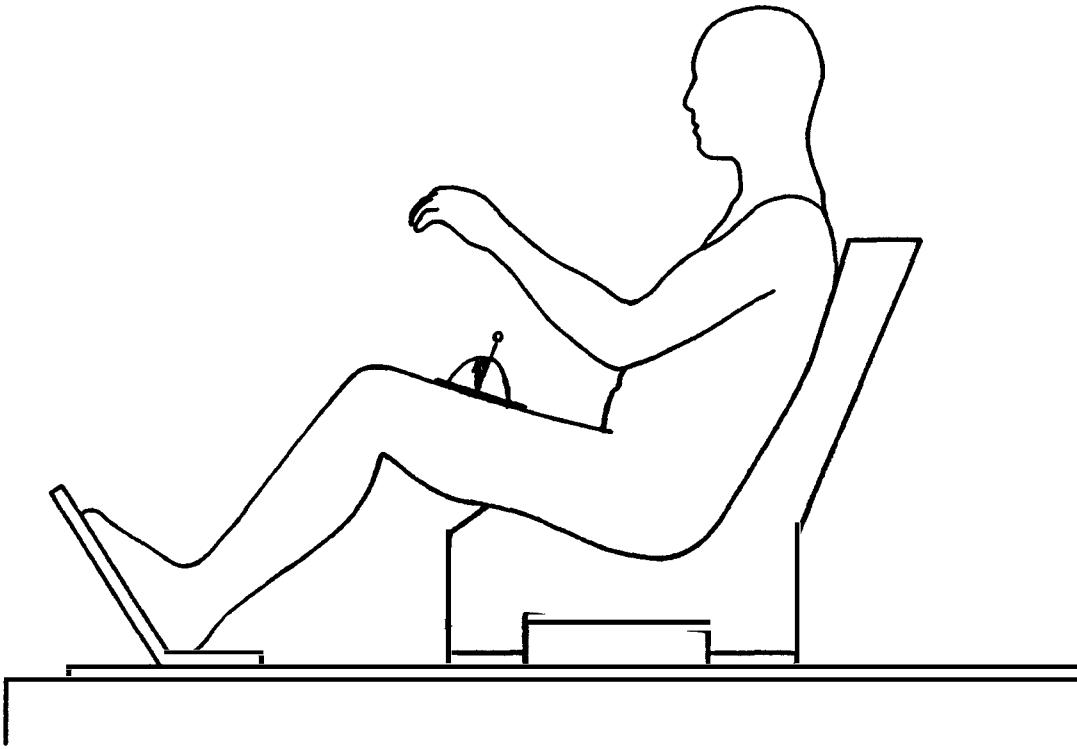
The subject sits in the contoured hardseat, feet placed firmly on the toeboard, head and body in a relaxed driving posture with the steering wheel removed and hands dropped to the sides of the seat. Use an anthropometer held horizontally to measure the breadth of the hips between the right and left trochanterion landmarks while pressing the tissue firmly with the blades. (The trochanterion landmark is a point on the surface of the skin obtained by palpating the most lateral margin of the greater trochanter of the femur.)



	N	Minimum	Maximum	Mean	Std Dev	CV %
Small Female	25	34.5 (13.6)	40.5 (15.9)	36.9 (14.5)	1.69 (cm) (0.67) (in)	4.59
Mid-Sized Male	25	30.6 (12.0)	38.8 (15.3)	32.9 (12.9)	1.66 (cm) (0.65) (in)	5.04
Large Male	25	33.4 (13.1)	44.4 (17.5)	38.5 (15.1)	2.33 (cm) (0.92) (in)	6.05

LEG ANGLE (upper)

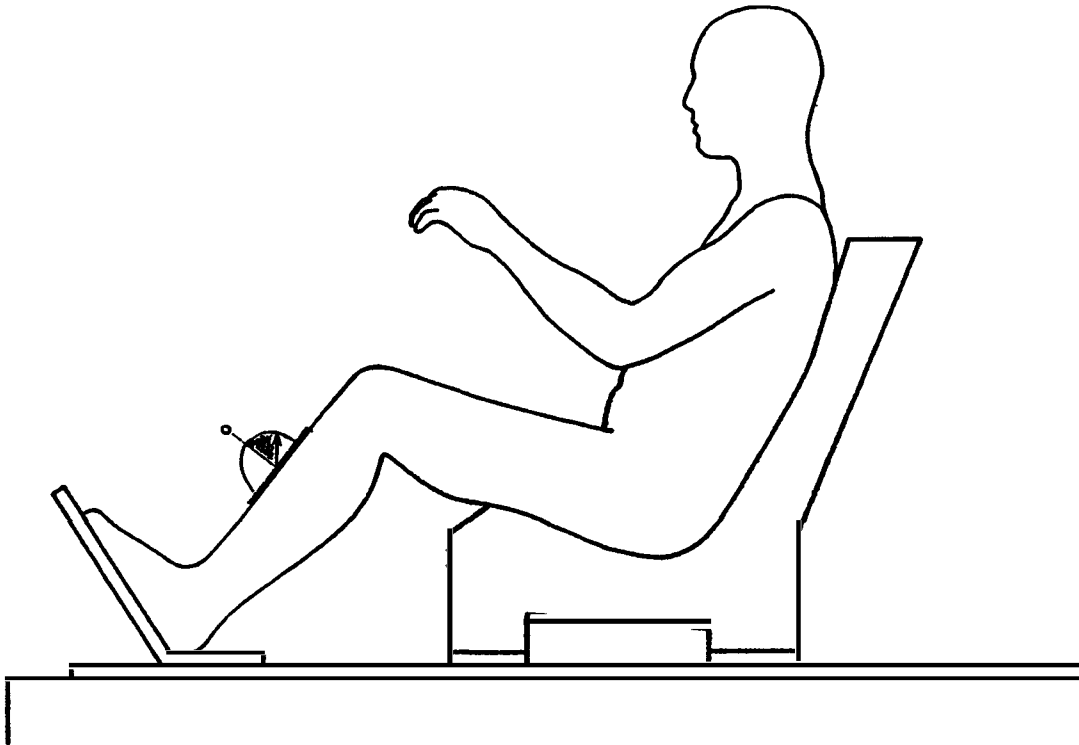
The subject sits in the contoured hardseat, feet placed firmly on the toeboard, head and body in a relaxed driving posture with the steering wheel removed and hands dropped to the sides of the seat. Place the flat surface of a modified "inclinometer" on the upper surface of the left upper leg along the long axis of the thigh. Read the angle of the needle which is the angle of the upper leg to the horizontal.



	N	Minimum	Maximum	Mean	Std Dev	CV %
Small Female	25	1.0 (0.4)	18.0 (7.1)	9.3 (3.7)	4.97 (cm) (1.96) (in)	53.35
Mid-Sized Male	25	10.0 (3.9)	24.0 (9.4)	18.1 (7.1)	4.28 (cm) (1.68) (in)	23.69
Large Male	25	12.0 (4.7)	24.0 (9.4)	19.1 (7.5)	3.25 (cm) (1.28) (in)	17.05

LEG ANGLE (lower)

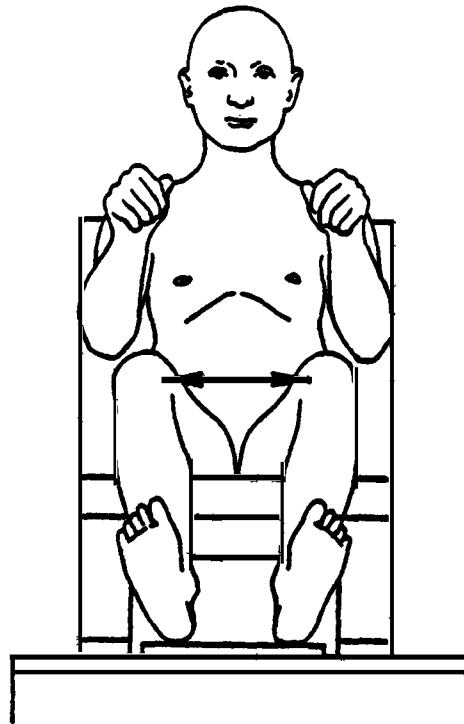
The subject sits in the contoured hardseat, feet placed firmly on the toeboard, head and body in a relaxed driving posture with the steering wheel removed and hands dropped to the sides of the seat. Place the flat surface of a modified "inclinometer" on the upper surface of the left lower leg along the long axis of the tibia. Read the angle of the needle which is the angle of the lower leg to the horizontal.



	N	Minimum	Maximum	Mean	Std Dev	CV %
Small Female	25	45.0 (17.7)	64.0 (25.2)	53.4 (21.0)	4.46 (cm) (1.76) (in)	8.35
Mid-Sized Male	25	42.0 (16.5)	58.0 (22.8)	52.6 (20.7)	3.47 (cm) (1.37) (in)	6.60
Large Male	25	47.0 (18.5)	56.0 (22.0)	51.7 (20.4)	2.81 (cm) (1.11) (in)	5.43

RIGHT-LEFT MEDIAL FEMORAL EPICONDYLE

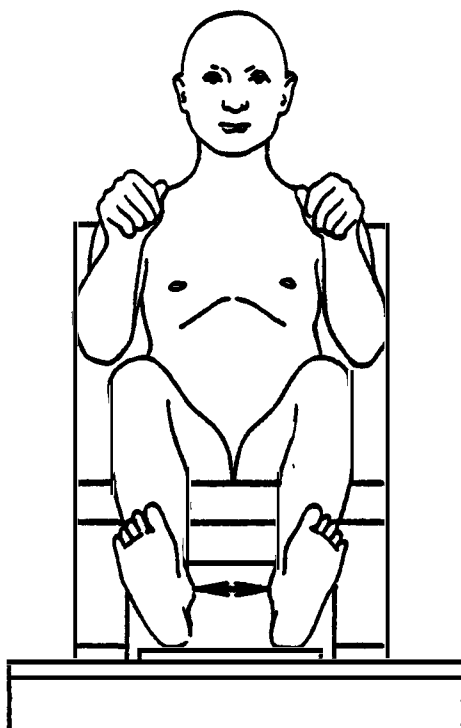
The subject sits in the contoured hardseat, feet placed firmly on the toeboard, head and body in a relaxed driving posture with the steering wheel removed and hands dropped to the sides of the seat. Use an anthropometer, with blades reversed, to measure the horizontal distance between the right and left medial femoral epicondyle landmarks. Add two centimeters to the measured value to correct for the reversed blades. (The medial femoral epicondyle landmark is a point on the surface of the skin obtained by palpating the most prominent aspect of the medial epicondyle of the femur.)



	N	Minimum	Maximum	Mean	Std Dev	CV %
Small Female	25	1.6 (0.6)	13.6 (5.4)	6.4 (2.5)	3.14 (cm) (1.24) (in)	49.04
Mid-Sized Male	25	9.2 (3.6)	27.0 (10.6)	17.4 (6.9)	4.43 (cm) (1.74) (in)	25.39
Large Male	25	12.4 (4.9)	27.9 (11.0)	19.6 (7.7)	4.48 (cm) (1.77) (in)	22.87

RIGHT-LEFT SPHYRION

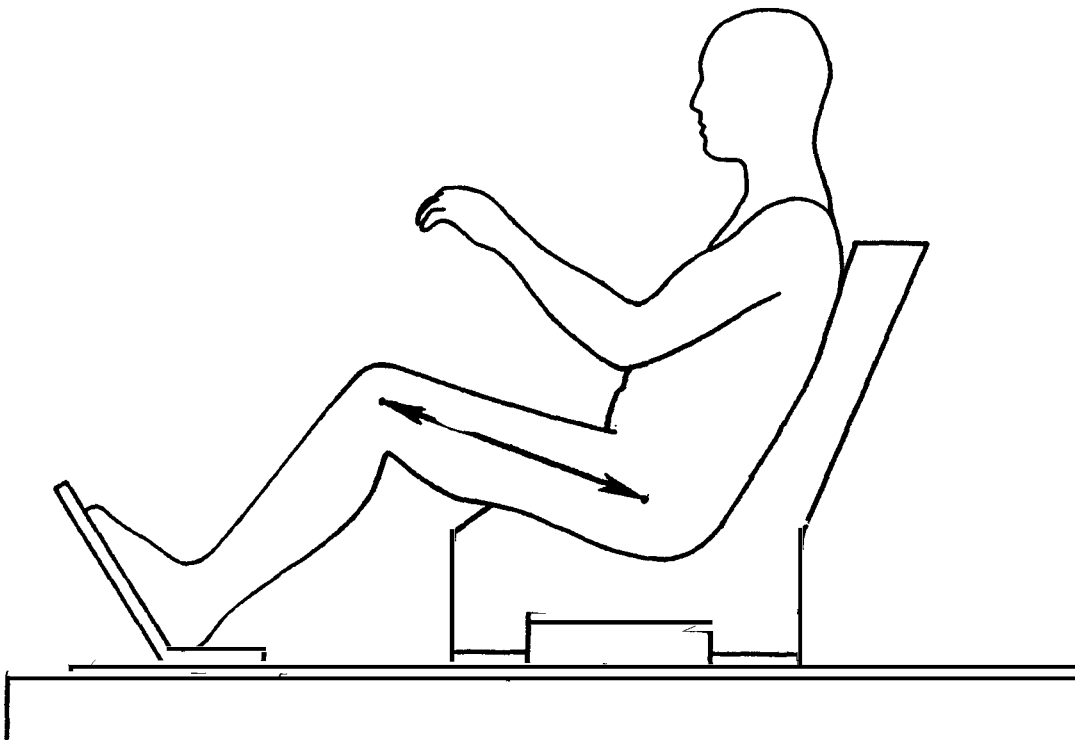
The subject sits in the contoured hardseat, feet placed firmly on the toeboard, head and body in a relaxed driving posture with the steering wheel removed and hands dropped to the sides of the seat. Use an anthropometer, with blades reversed, to measure the horizontal distance between the left and right sphyrion landmarks. Add two centimeters to the measured value to correct for the reversed blades. (The sphyrion landmark is a point on the surface of the skin obtained by palpating the most prominent aspect of the medial malleolus of the tibia.)



	N	Minimum	Maximum	Mean	Std Dev	CV %
Small Female	25	8.0 (3.1)	14.0 (5.5)	11.3 (4.4)	1.33 (cm) (0.52) (in)	11.81
Mid-Sized Male	25	10.7 (4.2)	14.9 (5.9)	12.2 (4.8)	1.08 (cm) (0.42) (in)	8.81
Large Male	25	9.8 (3.9)	15.5 (6.1)	12.6 (5.0)	1.47 (cm) (0.58) (in)	11.64

TROCHANTER-TO-LATERAL FEMORAL CONDYLE

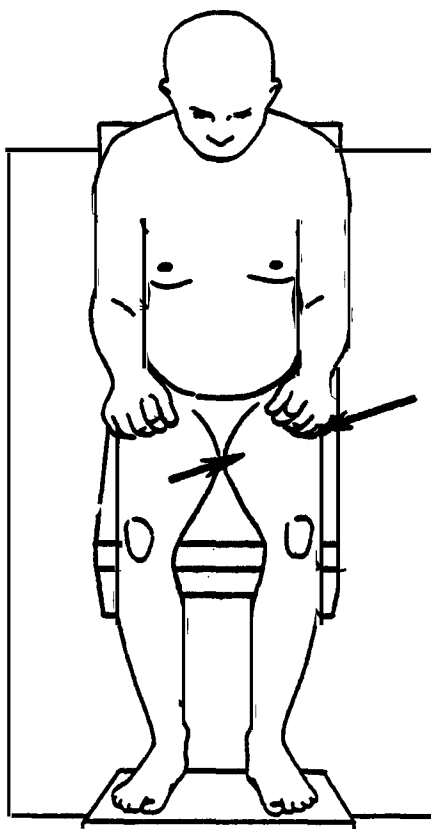
The subject sits in the contoured hardseat, feet placed firmly on the toeboard, head and body in a relaxed driving posture with the steering wheel removed and hands dropped to the sides of the seat. Use an anthropometer to measure the distance between the left trochanterion landmark and the left lateral femoral condyle landmark. (The trochanterion landmark is a point on the surface of the skin obtained by palpating the most lateral margin of the greater trochanter of the femur. The lateral femoral condyle landmark is a point on the surface of the skin obtained by palpating the most prominent aspect of the lateral condyle of the femur.)



	N	Minimum	Maximum	Mean	Std Dev	CV %
Small Female	25	35.1 (13.8)	41.2 (16.2)	38.1 (15.0)	1.83 (cm) (0.72) (in)	4.79
Mid-Sized Male	23	41.4 (16.3)	48.8 (19.2)	44.7 (17.6)	1.82 (cm) (0.72) (in)	4.07
Large Male	24	43.0 (16.9)	51.1 (20.1)	46.6 (18.4)	2.03 (cm) (0.80) (in)	4.35

THIGH BREADTH (upper)

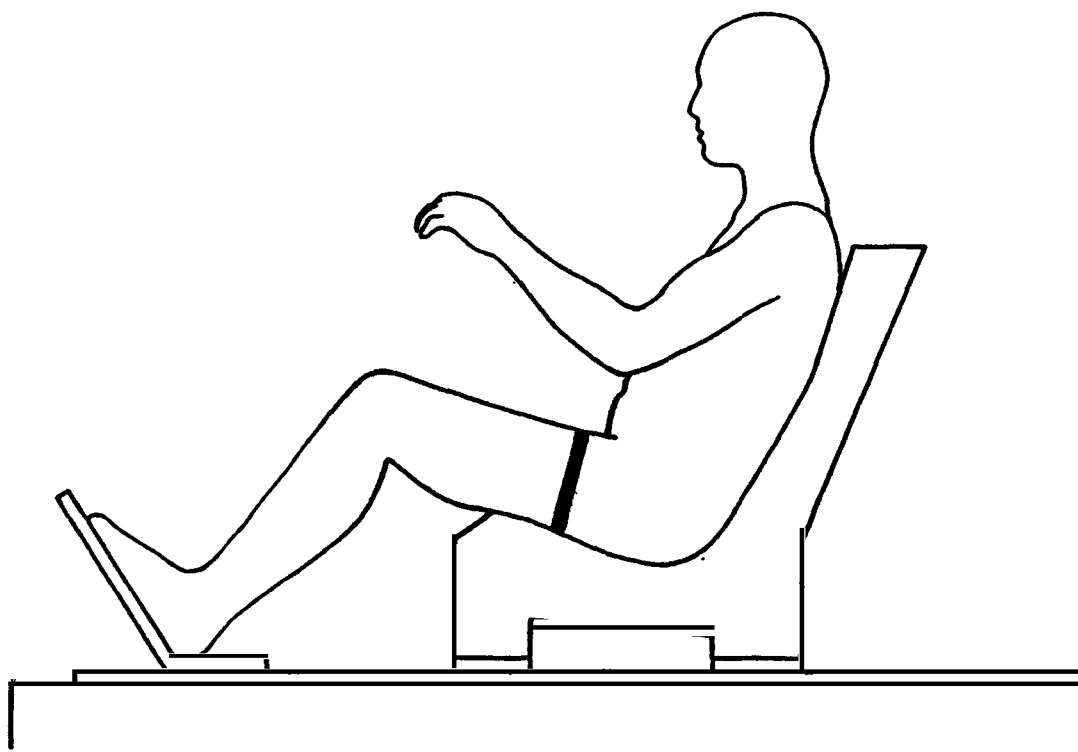
The subject sits in the contoured hardseat, feet placed firmly on the toeboard, head and body in a relaxed driving posture with the steering wheel removed and hands dropped to the sides of the seat. Use an anthropometer held perpendicular to the long axis of the upper leg to measure the breadth of the thigh at the thigh upper landmark. (The thigh upper landmark is a point marked on the lateral surface of the thigh at the estimated maximum circumference.)



	N	Minimum	Maximum	Mean	Std Dev	CV %
Small Female	25	14.5 (5.7)	21.4 (8.4)	17.6 (6.9)	1.53 (cm) (0.60) (in)	8.70
Mid-Sized Male	25	16.2 (6.4)	22.4 (8.8)	19.4 (7.6)	1.32 (cm) (0.52) (in)	6.80
Large Male	25	18.7 (7.4)	24.8 (9.8)	21.4 (8.4)	1.59 (cm) (0.63) (in)	7.45

THIGH CIRCUMFERENCE (upper)

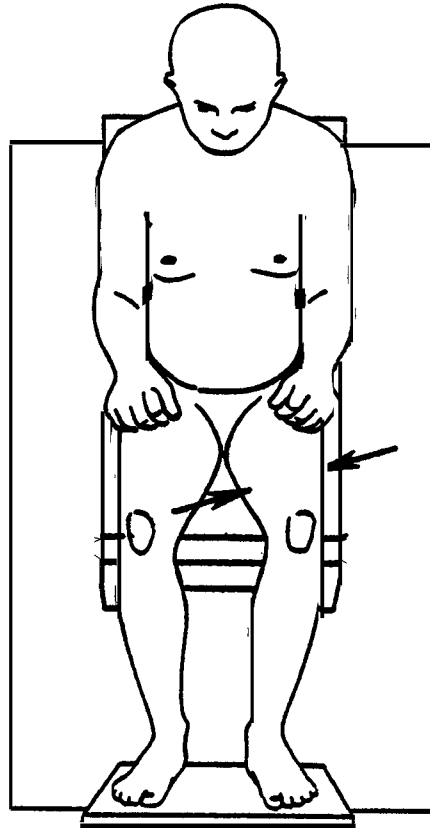
The subject sits in the contoured hardseat, feet placed firmly on the toeboard, head and body in a relaxed driving posture with the steering wheel removed and hands dropped to the sides of the seat. Use a steel tape to measure the circumference of the left thigh in a plane perpendicular to the long axis of the upper leg at the thigh upper landmark. The subject raises the left leg while the tape is positioned and then lowers the leg just before the measurement is taken. (The thigh upper landmark is a point marked on the lateral surface of the thigh at the estimated maximum circumference.)



	N	Minimum	Maximum	Mean	Std Dev		CV %
Small Female	25	45.8 (18.0)	56.7 (22.3)	50.1 (19.7)	2.63 (1.04)	(cm) (in)	5.26
Mid-Sized Male	25	53.4 (21.0)	64.0 (25.2)	57.9 (22.8)	3.08 (1.21)	(cm) (in)	5.32
Large Male	25	56.8 (22.4)	69.7 (27.4)	63.9 (25.2)	3.28 (1.29)	(cm) (in)	5.13

THIGH BREADTH (mid)

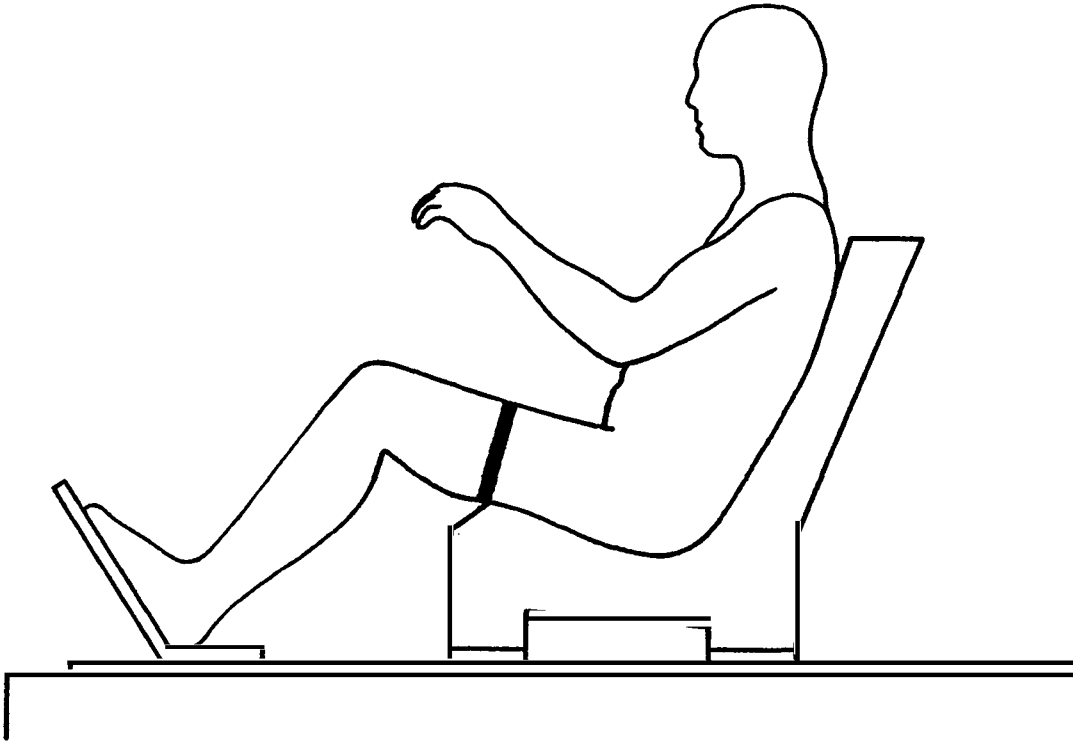
The subject sits in the contoured hardseat, feet placed firmly on the toeboard, head and body in a relaxed driving posture with the steering wheel removed and hands dropped to the sides of the seat. Use an anthropometer held perpendicular to the long axis of the upper leg to measure the breadth of the thigh at the thigh mid landmark. (The thigh mid landmark is a point marked on the lateral surface of the thigh approximately halfway between the estimated maximum circumference and the knee.)



	N	Minimum	Maximum	Mean	Std Dev	CV %
Small Female	25	9.9 (3.9)	14.5 (5.7)	12.5 (4.9)	1.27 (cm) (0.50) (in)	10.11
Mid-Sized Male	25	13.2 (5.2)	17.5 (6.9)	15.5 (6.1)	1.22 (cm) (0.48) (in)	7.87
Large Male	25	13.9 (5.5)	19.0 (7.5)	16.9 (6.6)	1.21 (cm) (0.48) (in)	7.19

THIGH CIRCUMFERENCE (mid)

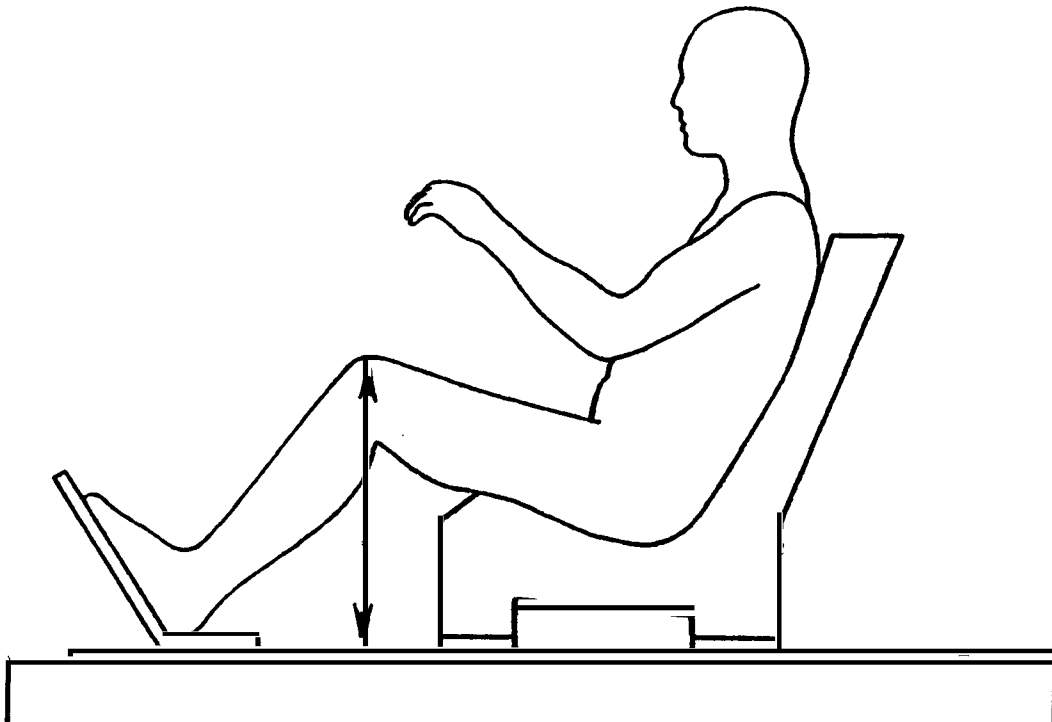
The subject sits in the contoured hardseat, feet placed firmly on the toeboard, head and body in a relaxed driving posture with the steering wheel removed and hands dropped to the sides of the seat. Use a steel tape to measure the circumference of the left thigh in a plane perpendicular to the long axis of the upper leg at the thigh mid landmark. The subject raises the left leg while the tape is positioned and then lowers the leg just before the measurement is taken. (The thigh mid landmark is a point marked on the lateral surface of the thigh approximately halfway between the estimated maximum circumference and the knee.)



	N	Minimum	Maximum	Mean	Std Dev	CV %
Small Female	25	37.0 (14.6)	47.2 (18.6)	42.7 (16.8)	2.41 (cm) (0.95) (in)	5.64
Mid-Sized Male	25	44.2 (17.4)	55.0 (21.7)	50.4 (19.8)	3.03 (cm) (1.19) (in)	6.01
Large Male	25	48.5 (19.1)	63.5 (25.0)	55.9 (22.0)	3.47 (cm) (1.37) (in)	6.22

KNEE HEIGHT

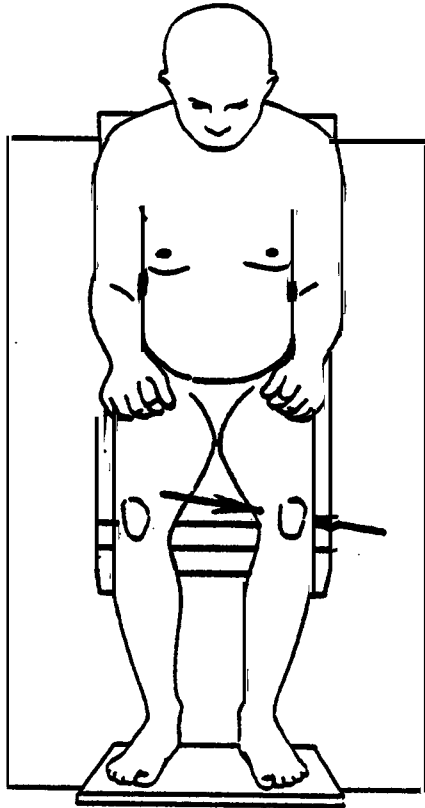
The subject sits in the contoured hardseat, feet placed firmly on the toeboard, hands on the steering wheel at the 10 o'clock and 2 o'clock positions, the head and body in a relaxed driving posture. Use an anthropometer to measure the vertical distance from the reference surface to the most superior point on the left knee.



	N	Minimum	Maximum	Mean	Std Dev	CV %
Small Female	25	33.8 (13.3)	44.5 (17.5)	38.8 (15.3)	2.55 (cm) (1.00) (in)	6.56
Mid-Sized Male	25	40.9 (16.1)	48.2 (19.0)	45.3 (17.8)	2.27 (cm) (0.89) (in)	5.02
Large Male	25	43.3 (17.0)	52.2 (20.6)	47.8 (18.8)	2.01 (cm) (0.79) (in)	4.22

KNEE BREADTH

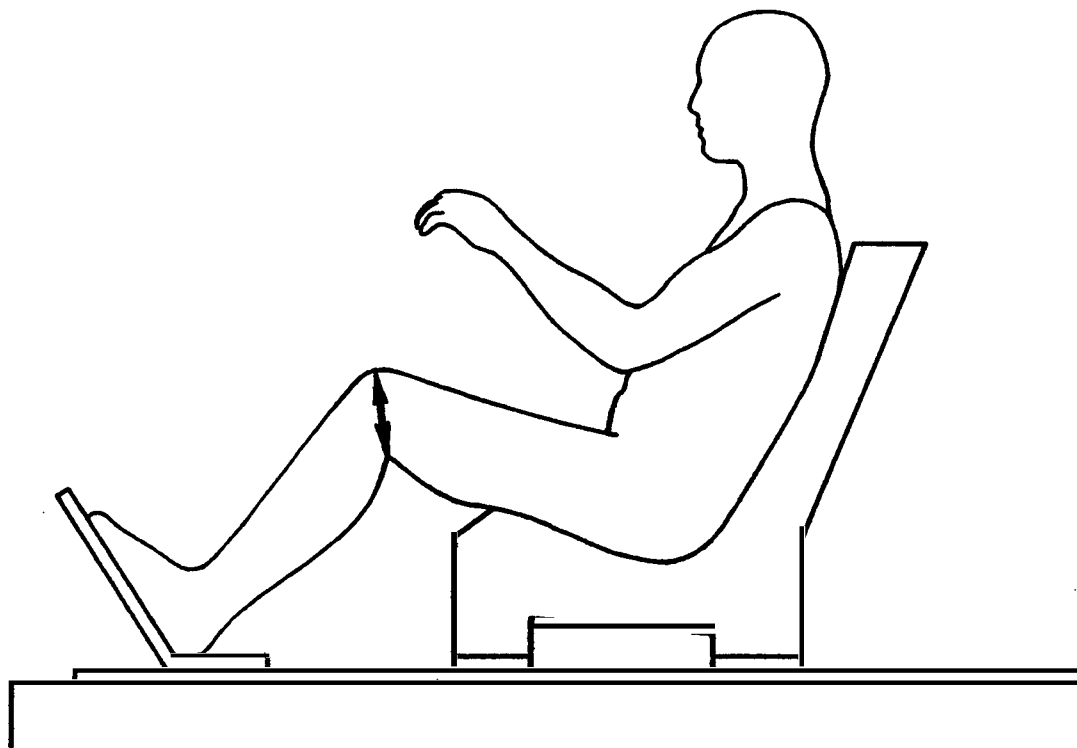
The subject sits in the contoured hardseat, feet placed firmly on the toeboard, head and body in a relaxed driving posture with the steering wheel removed and hands dropped to the sides of the seat. Use an anthropometer to measure the breadth of the left knee across the lateral and medial femoral (epi)condyle landmarks. (The medial femoral epicondyle landmark is a point on the surface of the skin obtained by palpating the most prominent aspect of the medial epicondyle of the femur. The lateral femoral condyle landmark is a point on the surface of the skin obtained by palpating the most prominent aspect of the lateral condyle of the femur.)



	N	Minimum	Maximum	Mean	Std Dev	CV %
Small Female	25	7.6 (3.0)	10.3 (4.1)	8.7 (3.4)	0.63 (cm) (0.25) (in)	7.20
Mid-Sized Male	25	9.2 (3.6)	11.0 (4.3)	10.1 (4.0)	0.47 (cm) (0.18) (in)	4.60
Large Male	25	10.3 (4.1)	12.3 (4.8)	11.1 (4.4)	0.49 (cm) (0.19) (in)	4.42

KNEE DEPTH (popliteal)

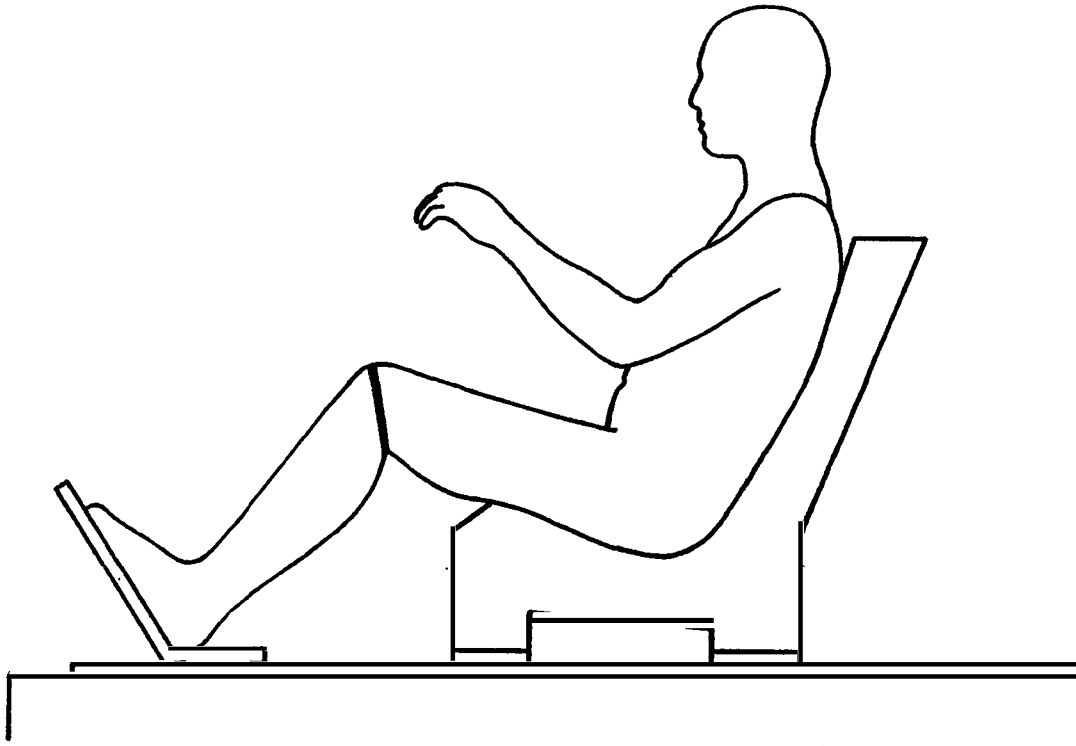
The subject sits in the contoured hardseat, feet placed firmly on the toeboard, head and body in a relaxed driving posture with the steering wheel removed and hands dropped to the sides of the seat. Use an anthropometer to measure the depth of the left knee from the superior margin of the popliteal crease to the most superior aspect of the patella.



	N	Minimum	Maximum	Mean	Std Dev	CV %
Small Female	25	10.1 (4.0)	11.9 (4.7)	11.1 (4.4)	0.47 (cm) (0.18) (in)	4.18
Mid-Sized Male	25	12.2 (4.8)	14.0 (5.5)	13.2 (5.2)	0.56 (cm) (0.22) (in)	4.22
Large Male	25	13.2 (5.2)	16.1 (6.3)	14.5 (5.7)	0.66 (cm) (0.26) (in)	4.56

KNEE CIRCUMFERENCE

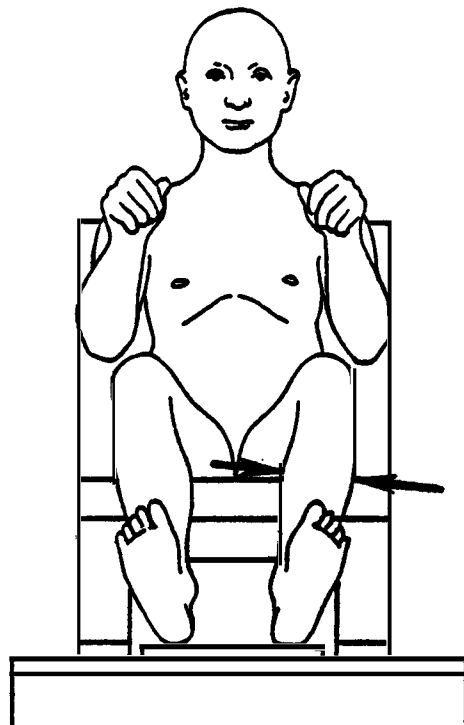
The subject sits in the contoured hardseat, feet placed firmly on the toeboard, head and body in a relaxed driving posture with the steering wheel removed and hands dropped to the sides of the seat. Use a steel tape to measure the circumference of the left knee in a plane through the popliteal crease and the most superior aspect of the patella.



	N	Minimum	Maximum	Mean	Std Dev	CV %
Small Female	25	31.5 (12.4)	37.0 (14.6)	33.9 (13.3)	1.57 (cm) (0.62) (in)	4.62
Mid-Sized Male	25	36.3 (14.3)	41.9 (16.5)	39.2 (15.4)	1.38 (cm) (0.54) (in)	3.52
Large Male	25	40.5 (15.9)	45.6 (18.0)	43.4 (17.1)	1.27 (cm) (0.50) (in)	2.93

CALF BREADTH

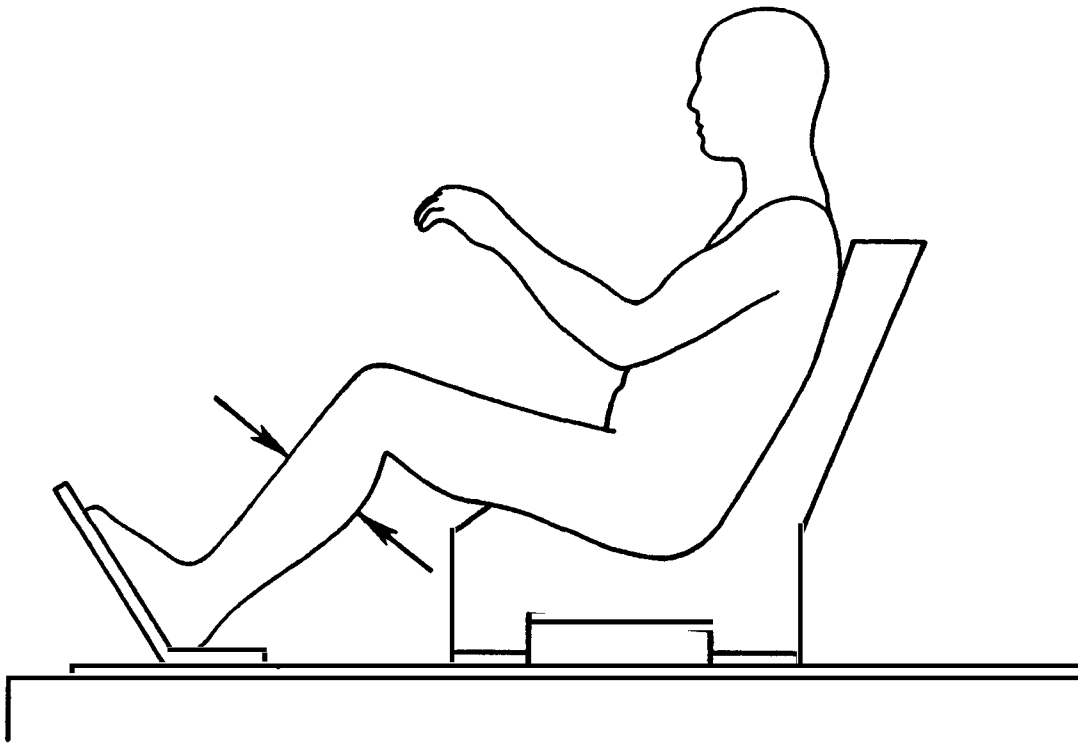
The subject sits in the contoured hardseat, feet placed firmly on the toeboard, head and body in a relaxed driving posture with the steering wheel removed and hands dropped to the sides of the seat. Use an anthropometer held perpendicular to the long axis of the lower leg to measure the breadth of the left calf at the calf landmark. (The calf landmark is a point marked on the lateral surface of the calf at the estimated maximum circumference.)



	N	Minimum	Maximum	Mean	Std Dev	CV %
Small Female	25	8.3 (3.3)	10.5 (4.1)	9.4 (3.7)	0.55 (cm) (0.22) (in)	5.86
Mid-Sized Male	25	9.4 (3.7)	11.8 (4.6)	11.0 (4.3)	0.63 (cm) (0.25) (in)	5.73
Large Male	25	10.8 (4.3)	14.0 (5.5)	12.1 (4.7)	0.84 (cm) (0.33) (in)	7.01

CALF DEPTH

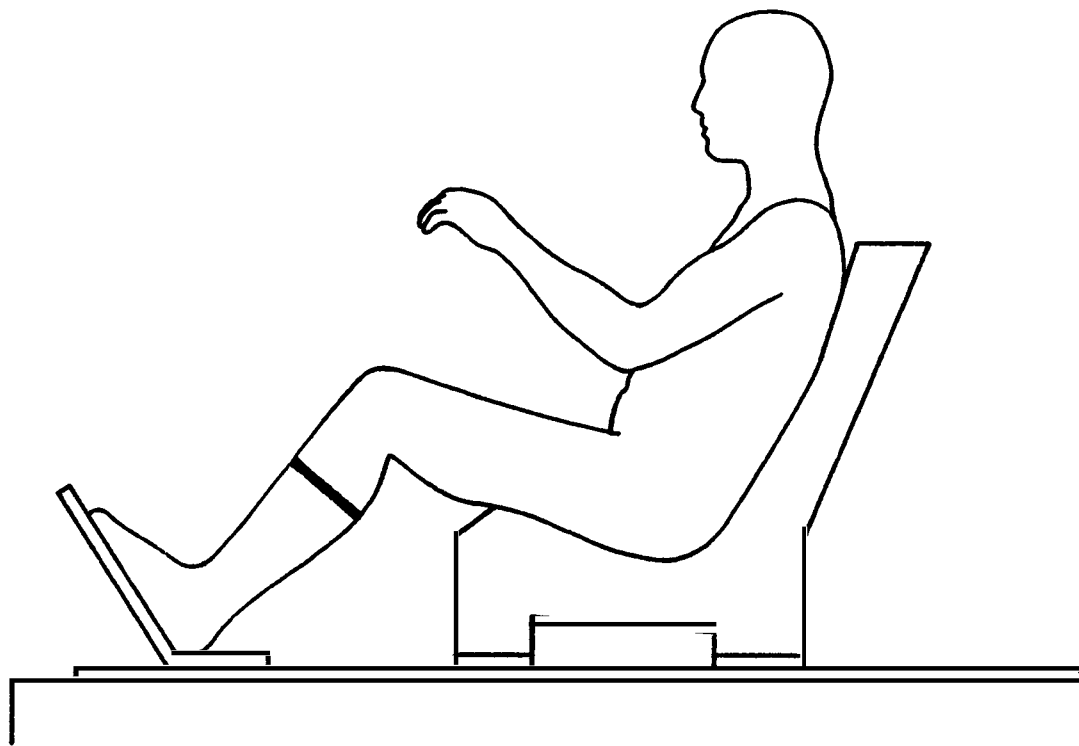
The subject sits in the contoured hardseat, feet placed firmly on the toeboard, head and body in a relaxed driving posture with the steering wheel removed and hands dropped to the sides of the seat. Use an anthropometer held perpendicular to the long axis of the lower leg to measure the depth of the left calf at the calf landmark. (The calf landmark is a point marked on the lateral surface of the calf at the estimated maximum circumference.)



	N	Minimum	Maximum	Mean	Std Dev	CV %
Small Female	25	8.5 (3.3)	10.6 (4.2)	9.6 (3.8)	0.55 (cm) (0.22) (in)	5.70
Mid-Sized Male	25	10.8 (4.3)	12.6 (5.0)	11.8 (4.6)	0.57 (cm) (0.22) (in)	4.83
Large Male	25	11.7 (4.6)	13.8 (5.4)	12.8 (5.0)	0.54 (cm) (0.21) (in)	4.20

CALF CIRCUMFERENCE

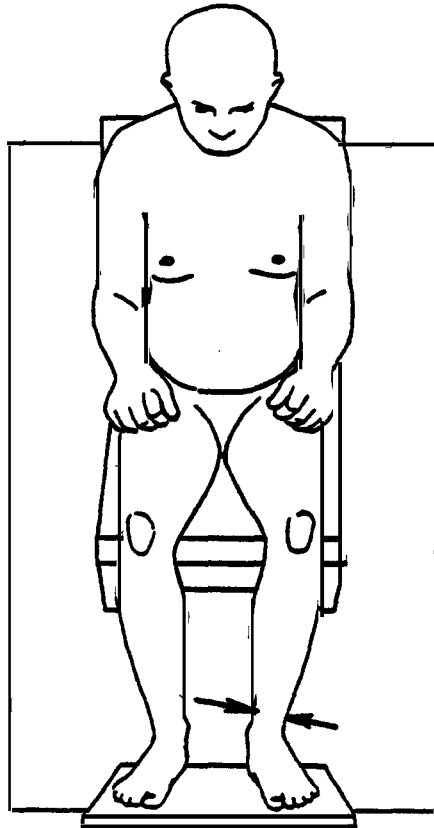
The subject sits in the contoured hardseat, feet placed firmly on the toeboard, head and body in a relaxed driving posture with the steering wheel removed and hands dropped to the sides of the seat. Use a steel tape to measure the circumference of the left calf in a plane perpendicular to the long axis of the lower leg at the level of the calf landmark. (The calf landmark is a point marked on the lateral surface of the calf at the estimated maximum circumference.)



	N	Minimum	Maximum	Mean	Std Dev	CV %
Small Female	25	28.3 (11.1)	34.5 (13.6)	31.5 (12.4)	1.39 (cm) (0.55) (in)	4.41
Mid-Sized Male	25	33.5 (13.2)	39.5 (15.6)	37.3 (14.7)	1.61 (cm) (0.63) (in)	4.32
Large Male	25	37.2 (14.6)	44.2 (17.4)	40.6 (16.0)	1.87 (cm) (0.74) (in)	4.61

ANKLE BREADTH (minimum)

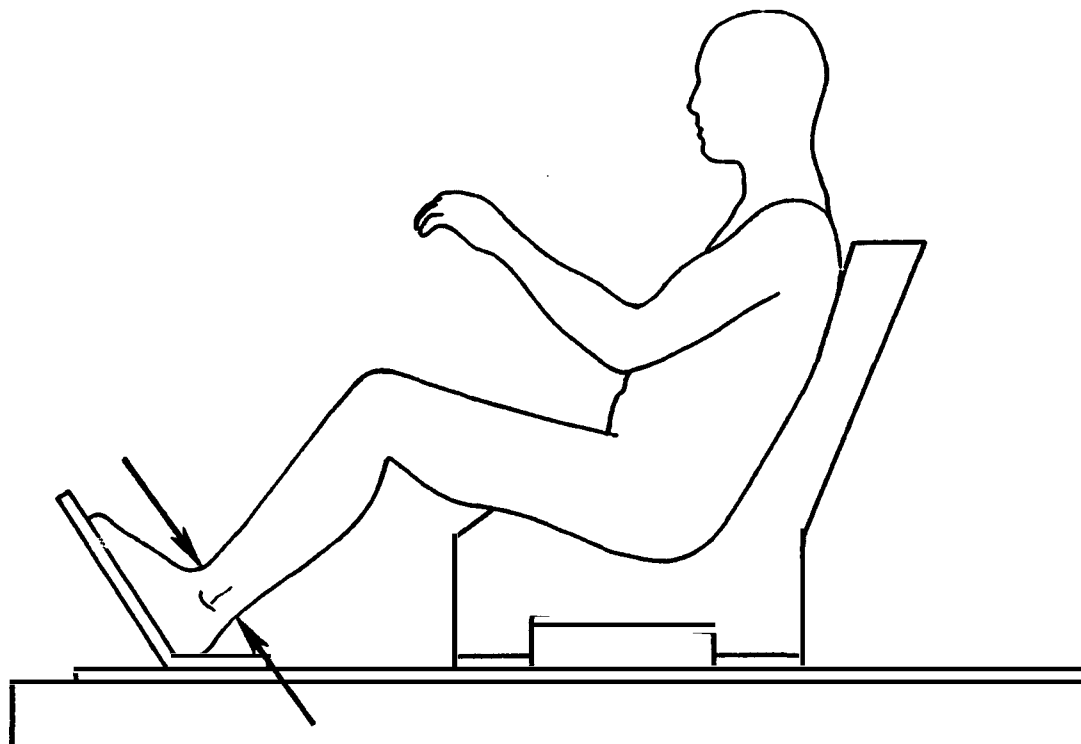
The subject sits in the contoured hardseat, feet placed firmly on the toeboard, head and body in a relaxed driving posture with the steering wheel removed and hands dropped to the sides of the seat. Use an anthropometer held perpendicular to the long axis of the lower leg to measure the breadth of the left ankle at the ankle landmark. (The ankle landmark is a point marked on the lateral surface of the lower leg at the estimated minimum circumference.)



	N	Minimum	Maximum	Mean	Std Dev	CV %
Small Female	25	4.4 (1.7)	7.0 (2.8)	6.0 (2.4)	0.56 (cm) (0.22) (in)	9.24
Mid-Sized Male	25	5.2 (2.0)	7.7 (3.0)	6.1 (2.4)	0.60 (cm) (0.23) (in)	9.73
Large Male	25	5.5 (2.2)	7.7 (3.0)	6.6 (2.6)	0.63 (cm) (0.25) (in)	9.50

ANKLE DEPTH (minimum)

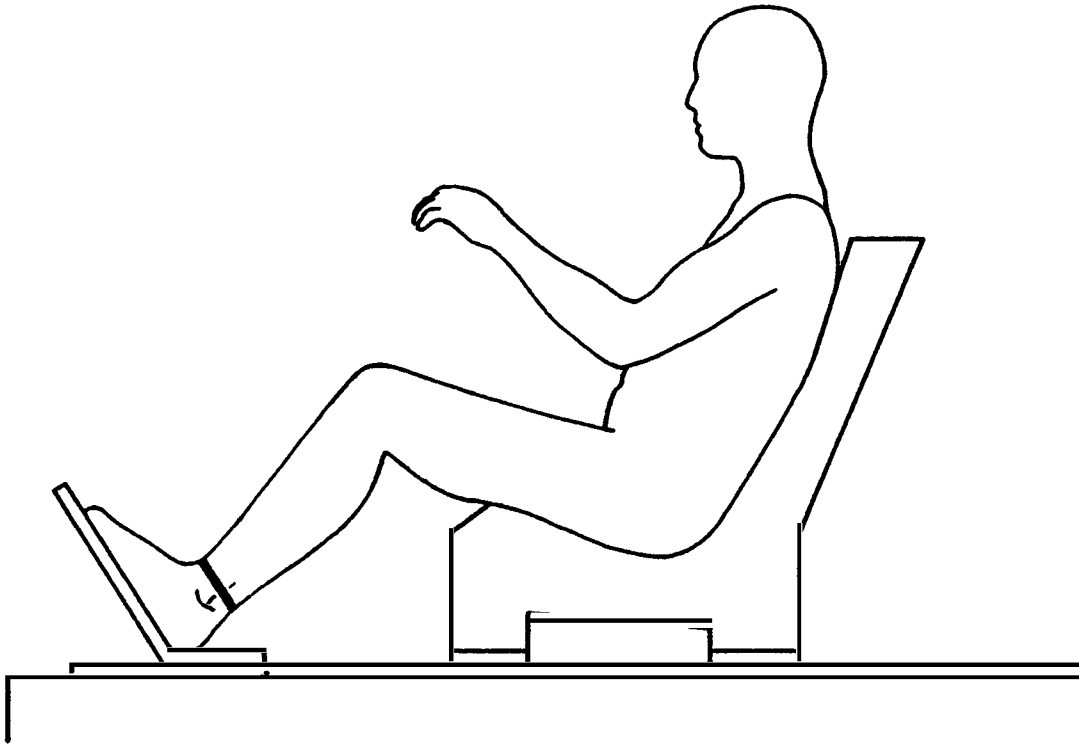
The subject sits in the contoured hardseat, feet placed firmly on the toeboard, head and body in a relaxed driving posture with the steering wheel removed and hands dropped to the sides of the seat. Use an anthropometer held perpendicular to the long axis of the lower leg to measure the depth of the left ankle at the ankle landmark. (The ankle landmark is a point marked on the lateral surface of the lower leg at the estimated minimum circumference.)



	N	Minimum	Maximum	Mean	Std Dev	CV %
Small Female	25	6.0 (2.4)	7.5 (3.0)	6.7 (2.7)	0.39 (cm) (0.15) (in)	5.73
Mid-Sized Male	25	7.0 (2.8)	9.2 (3.6)	7.6 (3.0)	0.55 (cm) (0.21) (in)	7.16
Large Male	23	7.2 (2.8)	9.0 (3.5)	8.2 (3.2)	0.47 (cm) (0.19) (in)	5.72

ANKLE CIRCUMFERENCE (minimum)

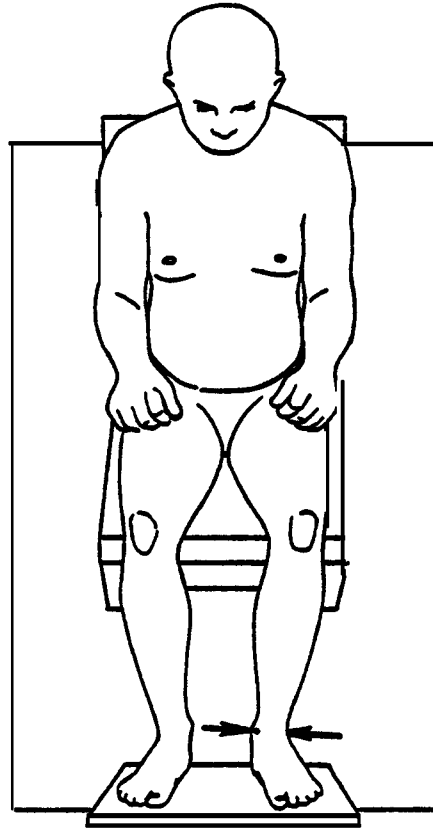
The subject sits in the contoured hardseat, feet placed firmly on the toeboard, head and body in a relaxed driving posture with the steering wheel removed and hands dropped to the sides of the seat. Use a steel tape to measure the circumference of the left ankle in a plane perpendicular to the long axis of the lower leg at the level of the ankle landmark. (The ankle landmark is a point marked on the lateral surface of the lower leg at the estimated minimum circumference.)



	N	Minimum	Maximum	Mean	Std Dev		CV %
Small Female	25	17.8 (7.0)	24.2 (9.5)	21.4 (8.4)	1.45 (0.57)	(cm) (in)	6.76
Mid-Sized Male	25	21.0 (8.3)	28.4 (11.2)	22.9 (9.0)	1.75 (0.69)	(cm) (in)	7.62
Large Male	24	21.2 (8.3)	28.3 (11.1)	24.7 (9.7)	1.82 (0.72)	(cm) (in)	7.36

ANKLE BREADTH (condyles)

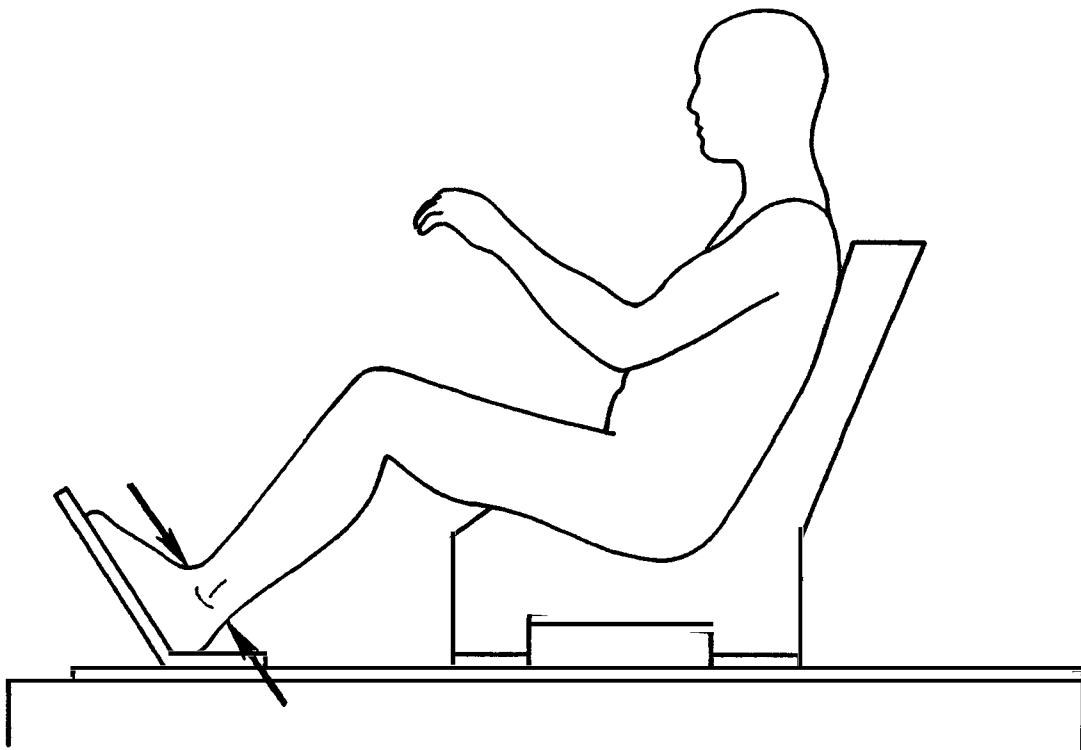
The subject sits in the contoured hardseat, feet placed firmly on the toeboard, head and body in a relaxed driving posture with the steering wheel removed and hands dropped to the sides of the seat. Use an anthropometer to measure the breadth of the left ankle from the lateral malleolus landmark to the sphyrion landmark. (The lateral malleolus landmark is a point on the surface of the skin obtained by palpating the most prominent aspect of the lateral malleolus of the fibula, i.e., outside of ankle. The sphyrion landmark is a point on the surface of the skin obtained by palpating the most prominent aspect of the medial malleolus of the tibia, i.e., inside of ankle.)



	N	Minimum	Maximum	Mean	Std Dev	CV %
Small Female	24	5.9 (2.3)	6.6 (2.6)	6.3 (2.5)	0.18 (cm, (0.07) (in)	2.82
Mid-Sized Male	25	6.7 (2.6)	8.0 (3.1)	7.3 (2.9)	0.31 (cm) (0.12) (in)	4.30
Large Male	25	6.6 (2.6)	8.5 (3.3)	7.7 (3.0)	0.44 (cm) (0.17) (in)	5.62

ANKLE DEPTH (condyles)

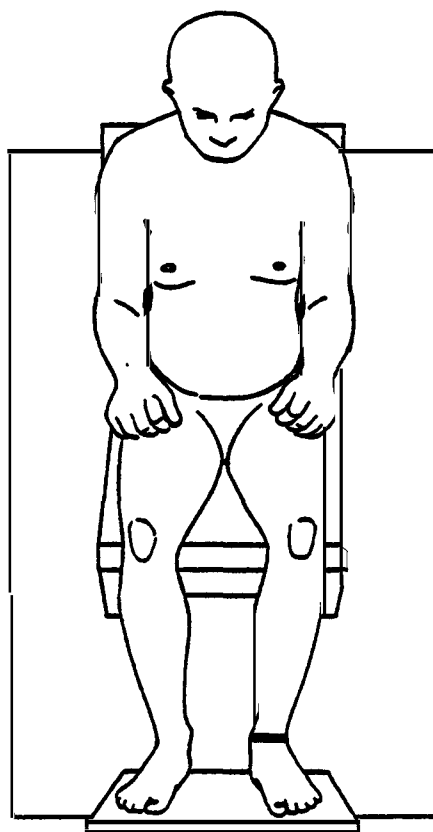
The subject sits in the contoured hardseat, feet placed firmly on the toeboard, head and body in a relaxed driving posture with the steering wheel removed and hands dropped to the sides of the seat. Use an anthropometer held perpendicular to the long axis of the lower leg to measure the depth of the left ankle at the level of the lateral malleolus landmark and the sphyrion landmark. (The lateral malleolus landmark is a point on the surface of the skin obtained by palpating the most prominent aspect of the lateral malleolus of the fibula, i.e., outside of ankle. The sphyrion landmark is a point on the surface of the skin obtained by palpating the most prominent aspect of the medial malleolus of the tibia. i.e., inside of ankle.)



	N	Minimum	Maximum	Mean	Std Dev	CV %
Small Female	25	7.3 (2.9)	8.9 (3.5)	8.1 (3.2)	0.45 (cm) (0.18) (in)	5.58
Mid-Sized Male	25	8.1 (3.2)	10.4 (4.1)	9.4 (3.7)	0.54 (cm) (0.21) (in)	5.79
Large Male	25	9.1 (3.6)	11.2 (4.4)	10.2 (4.0)	0.59 (cm) (0.23) (in)	5.84

ANKLE CIRCUMFERENCE (condyles)

The subject sits in the contoured hardseat, feet placed firmly on the toeboard, head and body in a relaxed driving posture with the steering wheel removed. Use a steel tape to measure the circumference of the left ankle in a plane through the lateral malleolus landmark and the sphyrion landmark. (The lateral malleolus landmark is a point on the surface of the skin obtained by palpating the most prominent aspect of the lateral malleolus of the fibula, i.e., outside of ankle. The sphyrion landmark is a point on the surface of the skin obtained by palpating the most prominent aspect of the medial malleolus of the tibia, i.e., inside of ankle.)



	N	Minimum	Maximum	Mean	Std Dev	CV %
Small Female	25	20.6 (8.1)	24.7 (9.7)	22.0 (8.7)	0.89 (cm) (0.35) (in)	4.05
Mid-Sized Male	25	24.5 (9.6)	28.4 (11.2)	26.1 (10.3)	1.10 (cm) (0.43) (in)	4.19
Large Male	24	26.2 (10.3)	31.2 (12.3)	28.7 (11.3)	1.16 (cm) (0.46) (in)	4.05

APPENDIX I

PHASE III MEASUREMENT RESULTS

(STATISTICS)

The following tables present the statistical results obtained from measurements taken in the contoured hardseats. Coordinate values given are in the laboratory system (X_L , Y_L , Z_L). Subscripts have been omitted from the tables to condense the listings.

INDEX TO TABLES

Table No.	Title	Page No.
1.1	Small Female Standard Anthropometry	1 - 2
1.2	Small Female Hardseat Anthropometry	1 - 3
1.3	Small Female Landmark Laboratory Coordinates	1 - 5
1.4	Mid-Sized Male Standard Anthropometry	1 - 10
1.5	Mid-Sized Male Hardseat Anthropometry	1 - 11
1.6	Mid-Sized Male Landmark Laboratory Coordinates	1 - 13
1.7	Large Male Standard Anthropometry	1 - 18
1.8	Large Male Hardseat Anthropometry	1 - 19
1.9	Large Male Surface Landmark Laboratory Coord.	1 - 21

TABLE 1.1

SMALL FEMALE STANDARD ANTHROPOMETRY
(Descriptive Statistics, cm or as noted)

Measurement Variable	N	Min.	Max.	Mean	S.D.
Age (years)	25	19.0	65.0	39.8	15.4
Stature	25	145.9	155.5	151.3	2.6
Weight (kg)	25	42.5	50.9	46.9	2.4
Sitting Height (erect)	25	78.5	85.0	81.2	1.9
Buttock-Knee Length	25	50.1	55.6	52.1	1.5
Cervicale Height	25	125.4	134.1	129.8	2.4
Trochanterion Height	25	65.6	77.5	71.8	2.8
Tibiale Height	25	37.4	45.3	41.0	2.0
Head Breadth	25	13.4	15.7	14.5	0.6
Head Length	25	17.4	19.7	18.3	0.6
Head Height	25	12.2	21.7	20.0	2.0
Shoulder Breadth	25	34.9	40.1	38.1	1.4
Biacromial Breadth	25	31.4	36.3	34.2	1.5
Clavicale Length	25	14.1	18.0	15.7	0.9
Suprasternale-Cerv. Dist.	25	9.1	11.2	10.2	0.6
Bispinous Breadth	25	18.3	22.3	20.6	1.1
Acromion-Radiale Length	25	23.9	31.7	27.6	1.6
Shoulder-Elbow Length	25	26.4	34.0	30.5	1.7
Elbow-Hand Length	25	37.4	43.4	40.0	1.5
Radius Length	25	20.4	24.6	22.5	1.0
Hand Breadth	25	6.6	7.9	7.2	0.4
Hand Length	25	14.6	18.3	16.2	0.8
Troch.-to-Lat. Fem. Condyle	25	28.0	37.7	32.9	2.1
Tibia Length	25	31.6	37.6	34.6	1.8
Foot Breadth	25	7.8	9.7	8.6	0.5
Foot Length	25	20.8	24.8	22.1	0.9
Head Circumference	25	51.0	56.7	53.4	1.4
Shoulder Circumference	25	85.2	99.5	92.5	3.0
Chest Circumference (axilla)	25	73.0	85.6	79.2	3.5
Chest Circumference (nipple)	25	70.3	90.3	80.9	4.5
Waist Circumference	25	58.1	73.6	66.0	4.3
Hip Circumference	25	80.3	96.0	87.8	3.3
Upper Arm Circumference (biceps)	25	22.6	27.5	25.0	1.4
Forearm Circumference	25	19.1	23.2	20.9	1.0
Thigh Circumference (mid)	25	43.0	54.4	48.0	3.0
Calf Circumference	25	29.0	34.7	31.8	1.5
Skinfold, Subscapular (mm)	25	6.0	21.0	11.9	4.3
Skinfold, Triceps (mm)	25	8.0	22.0	15.1	4.2
Skinfold, Suprailiac (mm)	25	7.0	35.0	19.5	8.1
Skinfold, Posterior Mid-Calf (mm)	25	5.0	20.0	12.2	3.6

TABLE 1.2

SMALL FEMALE CONTOURED HARDSEAT ANTHROPOMETRY
(Descriptive Statistics, cm or as noted)

Measurement Variable	N	Min.	Max.	Mean	S.D.
Sitting Height	25	90.5	95.5	93.3	1.3
Cervicale Height	25	68.9	73.1	71.2	1.2
Chin Height	25	70.5	76.3	73.2	1.6
Neck Length (anterior)	25	5.8	10.6	8.1	1.2
Neck Breadth (mid)	25	8.1	11.0	9.1	0.6
Neck Depth (mid)	24	8.1	9.7	9.0	0.5
Neck Circumference (mid)	25	27.9	34.8	30.4	1.5
Neck Breadth (lower)	25	8.1	14.2	10.4	1.2
Neck Depth (lower)	25	7.9	10.0	9.3	0.5
Neck Circumference (lower)	25	29.4	36.4	32.2	1.6
Shoulder Height (mid)	25	65.9	70.4	68.2	1.3
Acromion Height	25	61.1	66.6	64.3	1.3
Clav.-to-Acr. Clavic. Artic	25	13.7	17.7	15.5	1.1
Shoulder Breadth	25	35.3	40.3	38.0	1.4
Shoulder Circumference	24	87.0	102.2	95.3	3.9
Biacromial Breadth	25	31.5	36.7	34.2	1.5
Torso Depth (upper)	25	7.4	11.0	9.0	1.1
Shoulder Depth (scye)	25	9.6	11.9	10.5	0.6
Axillary Depth	25	7.8	12.6	9.8	1.3
Arm Angle (upper)	25	36.0°	53.0°	43.3°	4.7
Arm Angle (lower)	25	31.0°	62.0°	50.4°	7.1
Right-Left Med. Hum. Epicondyle	25	24.8	39.8	30.0	3.2
Right-Left Stylion	25	23.4	34.7	27.2	2.6
Arm Circumference (scye)	25	33.0	42.0	36.9	2.2
Arm Breadth (upper)	25	5.8	7.6	6.7	0.4
Arm Depth (upper)	25	7.6	10.4	8.9	0.8
Arm Circumference (upper)	25	22.5	27.9	25.3	1.5
Arm Breadth (above elbow)	25	6.4	8.1	7.2	0.4
Arm Depth (above elbow)	25	6.3	8.7	7.4	0.6
Arm Circumference (above elbow)	25	21.2	27.3	24.0	1.4
Olecranon Height	25	39.7	48.1	44.4	2.0
Elbow Breadth	25	5.6	7.1	6.4	0.4
Elbow Depth	25	6.2	8.6	7.7	0.5
Elbow Circumference	25	21.5	25.4	23.3	1.0
Forearm Breadth (upper)	25	5.5	7.1	6.2	0.4
Forearm Depth (upper)	25	6.1	7.7	6.9	0.4
Forearm Circumference (upper)	25	19.7	23.8	21.5	1.1
Forearm Circumference (lower)	25	13.9	18.0	15.8	1.1
Wrist Breadth (condyles)	25	4.1	5.2	4.7	0.2
Wrist Depth (condyles)	25	3.0	3.9	3.4	0.2
Wrist Circumference (condyles)	24	13.0	15.1	14.2	0.5

TABLE 1.2
HARDSEAT ANTHROPOMETRY STATISTICS: SMALL FEMALE (Continued)

Measurement Variable	N	Min.	Max.	Mean	S.D.
Chest Height (nipple)	25	45.8	55.5	51.7	2.2
Chest Height (posterior scye) .	25	52.2	57.5	55.1	1.5
Chest Breadth (axilla)	25	23.8	29.4	26.0	1.2
Chest Circumference (axilla) .	25	75.0	89.0	82.4	3.9
Chest Breadth (nipple)	25	25.2	30.8	27.6	1.5
Chest Circumference (nipple) .	25	76.4	92.6	83.3	3.9
Chest Circumference (10th rib)	25	60.1	80.2	68.9	5.3
Waist Breadth (umbilicus) . . .	25	21.0	29.1	24.7	2.1
Waist Depth (umbilicus)	25	16.1	23.0	18.8	1.5
Waist Circumference (umbilicus)	25	61.1	84.4	70.8	5.3
Abdominal Breadth (maximum) . .	25	24.0	33.3	27.9	2.2
Abdominal Depth (maximum) . . .	25	18.0	24.4	21.0	1.6
Abdominal Circumference (max.)	25	67.5	89.2	75.4	5.0
Iliocristale Height	25	33.4	37.8	35.3	1.1
Thigh-Abdom. Junct. Height . .	25	30.7	34.5	32.7	0.9
Ant.-Sup. Iliac Spine Height .	25	32.3	36.6	34.2	0.9
Trochanterion Height	25	24.1	26.3	24.8	0.6
Hip Breadth (max.)	25	33.5	39.5	35.6	1.8
Bitrochanter Breadth	25	34.5	40.5	36.9	1.7
Leg Angle (upper)	25	1.0°	18.0°	9.3°	5.0
Leg Angle (lower)	25	45.0°	64.0°	53.4°	4.5
Right-Left Med. Fem. Epicondyle	25	1.6	13.6	6.4	3.1
Right-Left Sphyrion	25	8.0	14.0	11.3	1.3
Troc.-to-Lat. Fem. Condyle . .	25	35.1	41.2	38.1	1.8
Thigh Breadth (upper)	25	14.5	21.4	17.6	1.5
Thigh Circumference (upper) . .	25	45.8	56.7	50.1	2.6
Thigh Breadth (mid)	25	9.9	14.5	12.5	1.3
Thigh Circumference (mid) . . .	25	37.0	47.2	42.7	2.4
Knee Height	25	33.8	44.5	38.8	2.5
Knee Breadth	25	7.6	10.3	8.7	0.6
Knee Depth (popliteal)	25	10.1	11.9	11.1	0.5
Knee Circumference	25	31.5	37.0	33.9	1.6
Calf Breadth	25	8.3	10.5	9.4	0.6
Calf Depth	25	8.5	10.6	9.6	0.5
Calf Circumference	25	28.3	34.5	31.5	1.4
Ankle Breadth (min.)	25	4.4	7.0	6.0	0.6
Ankle Depth (min.)	25	6.0	7.5	6.7	0.4
Ankle Circumference (min.) . .	25	17.8	24.2	21.4	1.4
Ankle Breadth (condyles) . . .	24	5.9	6.6	6.3	0.2
Ankle Depth (condyles)	25	7.3	8.9	8.1	0.4
Ankle Circumference (condyles)	25	20.6	24.7	22.0	0.9

TABLE 1.3

SMALL FEMALE SURFACE LANDMARK LABORATORY COORDINATES
(Descriptive Statistics, mm)

Reference No. and Landmark	Coord.	N	Min.	Max.	Mean	S.D.
HEAD AND NECK:						
1. Glabella	X	25	625	720	665	25.0
	Y	25	598	645	619	11.5
	Z	25	974	1035	1003	17.0
2. Infraorbitale	X	25	613	707	652	24.7
	Y	25	627	676	651	11.9
	Z	25	946	1008	975	16.7
3. Tragion	X	22	537	631	575	25.8
	Y	22	666	705	686	9.9
	Z	22	946	988	970	12.6
4. Gonion	X	25	552	644	588	23.4
	Y	25	660	698	674	9.6
	Z	25	884	929	909	13.0
5. Gnathion	X	25	625	718	664	23.5
	Y	25	599	647	619	11.2
	Z	25	859	916	890	14.5
SPINE AND SCAPULA:						
7. C7	X	18	489	560	517	20.4
	Y	18	608	638	619	8.6
	Z	18	839	895	870	13.7
8. T4	X	24	480	535	496	13.5
	Y	24	609	637	619	6.4
	Z	24	746	829	789	22.5
9. T8	X	24	491	539	508	11.3
	Y	24	612	633	619	5.2
	Z	24	597	707	667	31.1
10. T12	X	23	533	583	555	13.7
	Y	23	611	631	619	5.1
	Z	23	512	579	547	17.4
11. L2	X	24	558	603	575	12.8
	Y	24	610	631	619	5.1
	Z	24	472	558	504	19.7
12. L5	X	21	580	618	601	10.9
	Y	21	613	627	619	3.5
	Z	21	426	492	448	16.7

TABLE 1.3
LANDMARK LABORATORY COORDINATE STATISTICS: SMALL FEMALE (Continued)

Reference No. and Landmark	Coord.	N	Min.	Max.	Mean	S.D.
SPINE AND SCAPULA (Continued)						
13. 10th Rib, mid-spine . . .	X	23	538	582	554	11.5
	Y	23	611	632	619	5.0
	Z	23	517	581	551	14.0
14. Scapula, Sup. Marg . . .	X	21	470	528	493	15.4
	Y	21	649	712	685	15.3
	Z	21	787	840	804	14.2
15. Scapula, Inf. Marg . . .	X	24	480	541	505	17.7
	Y	24	712	749	728	10.9
	Z	24	692	741	717	13.3
CHEST AND TORSO:						
18. Suprasternale	X	25	583	654	611	17.8
	Y	25	608	635	619	5.9
	Z	25	789	836	816	11.3
19. Mesosternale	X	25	621	674	645	14.9
	Y	25	608	633	619	5.7
	Z	25	743	805	778	13.7
20. Substernale	X	25	639	690	666	12.5
	Y	25	605	628	619	5.5
	Z	25	700	768	741	14.7
21. Bimammary Midline	X	0	---	---	---	--
	Y	0	---	---	---	--
	Z	0	---	---	---	--
22. Nipple	X	25	690	756	716	15.2
	Y	25	683	726	704	11.1
	Z	25	614	704	675	20.9
23. 10th Rib, Ant. Midline .	X	24	720	779	745	16.3
	Y	24	611	627	619	4.9
	Z	24	559	594	575	9.0
24. Umbilicus	X	25	733	789	756	16.6
	Y	25	611	626	619	4.2
	Z	25	551	587	566	9.9
25. Max. Abdom. Protrusion .	X	25	750	806	777	15.9
	Y	25	611	626	619	4.9
	Z	25	530	575	554	11.2
26. 10th Rib	X	25	641	678	659	10.2
	Y	25	725	767	748	9.5
	Z	25	530	582	550	10.7

TABLE 1.3
LANDMARK LABORATORY COORDINATE STATISTICS: SMALL FEMALE (Continued)

Reference No. and Landmark	Coord.	N	Min.	Max.	Mean	S.D.
PELVIS AND HIP:						
27. Iliocristale	X	25	659	689	672	8.3
	Y	25	739	779	757	10.1
	Z	25	493	537	511	11.5
28. Ant. Sup. Iliac Spine . .	X	25	715	758	740	10.1
	Y	25	708	743	722	8.8
	Z	25	481	526	500	10.5
29. Pubic Symphysis	X	25	773	814	799	9.3
	Y	25	600	641	619	8.6
	Z	25	440	473	457	10.3
30. Thigh-Abdom. Junction . .	X	25	750	796	777	10.3
	Y	25	715	757	736	11.4
	Z	25	467	500	485	8.3
31a. Trochanterion (palpated)	X	25	724	776	752	13.3
	Y	25	786	832	806	12.7
	Z	25	394	422	406	7.1
31b. Trochanterion (reconstr.)	X	--	---	---	773	---
	Y	--	---	---	809	---
	Z	--	---	---	407	---
SHOULDER:						
33. Clavicale	X	25	588	654	609	19.7
	Y	25	627	652	636	6.7
	Z	25	791	851	822	12.6
34. Acr.-Clav. Artic	X	25	518	601	557	20.4
	Y	25	748	795	771	11.7
	Z	25	794	858	823	13.4
35. Gr. Tubercle Humerus . .	X	25	560	644	603	19.9
	Y	25	781	818	797	9.9
	Z	25	778	831	805	11.9
36. Acromion	X	25	501	591	549	21.6
	Y	25	767	812	790	10.2
	Z	25	770	828	801	13.9
37. Scye, anterior	X	25	610	680	649	19.0
	Y	25	735	767	749	9.0
	Z	25	723	795	762	16.0
38. Scye, posterior	X	23	539	588	564	13.6
	Y	23	763	805	783	9.7
	Z	23	678	736	711	16.6

TABLE 1.3
LANDMARK LABORATORY COORDINATE STATISTICS: SMALL FEMALE (Continued)

Reference No. and Landmark	Coord.	N	Min.	Max.	Mean	S.D.
ARM AND HAND:						
39. Lat. Humeral Epicondyle .	X	25	719	815	767	20.0
	Y	25	806	865	830	14.0
	Z	25	577	671	631	24.0
40. Radiale	X	25	734	835	783	20.5
	Y	25	807	865	826	15.0
	Z	25	565	658	618	23.6
41. Med. Humeral Epicondyle .	X	25	718	816	770	20.6
	Y	25	741	810	769	15.5
	Z	25	562	651	615	20.4
42. Olecranon	X	25	738	843	789	22.7
	Y	25	776	851	802	17.5
	Z	25	555	644	602	22.0
43. Ulnar Styloid	X	25	868	905	885	9.0
	Y	25	782	832	801	11.7
	Z	25	771	848	808	18.3
44. Stylium	X	25	856	886	876	8.4
	Y	25	733	792	755	12.9
	Z	25	779	841	812	17.2
LEG AND FOOT:						
45. Lat. Femoral Condyle . .	X	25	1092	1147	1115	12.5
	Y	25	668	796	738	27.0
	Z	25	448	545	497	24.1
46. Med. Femoral Epicondyle .	X	25	1102	1141	1120	9.6
	Y	25	593	706	651	24.8
	Z	25	443	556	494	27.0
47. Tibiale	X	25	1117	1156	1133	9.1
	Y	25	596	709	654	24.5
	Z	25	430	545	483	26.3
48. Patella	X	24	1140	1191	1159	11.8
	Y	24	627	767	700	29.1
	Z	24	459	571	516	25.7
49. Sphyrion	X	25	1339	1370	1354	8.1
	Y	25	649	696	676	9.3
	Z	25	247	263	253	4.4
50. Metatarsal/Phalangeal I .	X	25	1443	1463	1453	5.3
	Y	25	679	712	695	7.6
	Z	25	293	321	305	7.9

TABLE 1.3
LANDMARK LABORATORY COORDINATE STATISTICS: SMALL FEMALE (Continued)

Reference No. and Landmark	Coord.	N	Min.	Max.	Mean	S.D.
LEG AND FOOT (Continued)						
51. Digit II	X	24	1472	1498	1484	6.4
	Y	24	726	763	745	9.8
	Z	24	336	371	351	8.6
52. Metatarsal/Phalangeal V .	X	25	1428	1449	1438	5.6
	Y	25	758	808	776	10.7
	Z	25	259	300	278	9.1
53. Lateral Malleolus	X	25	1327	1349	1339	6.7
	Y	25	704	752	734	10.4
	Z	25	221	239	231	5.2
ANTHRO. MEASUREMENT POINTS						
93. Neck, mid	X	24	537	616	569	21.3
	Y	24	652	682	665	8.3
	Z	24	855	898	881	12.1
94. Neck, lower	X	24	531	611	562	21.1
	Y	24	656	687	671	7.6
	Z	24	832	874	856	12.8
95. Arm, upper	X	25	617	692	658	19.3
	Y	25	799	836	818	8.6
	Z	25	693	760	731	15.3
96. Forearm, upper	X	25	771	844	813	15.9
	Y	25	809	851	826	12.3
	Z	25	645	720	688	21.4
97. Forearm, lower	X	25	833	876	853	10.7
	Y	25	791	838	809	11.2
	Z	25	712	787	751	20.2
98. Thigh, upper	X	25	839	891	868	13.8
	Y	25	749	830	788	19.4
	Z	25	442	487	458	10.5
99. Thigh, mid	X	25	941	1008	976	13.3
	Y	25	720	812	766	21.3
	Z	25	455	530	483	19.0
100. Calf	X	25	1181	1213	1198	8.1
	Y	25	705	792	755	20.6
	Z	25	350	450	381	23.4
101. Ankle	X	25	1261	1303	1281	10.8
	Y	25	690	762	736	14.6
	Z	25	265	337	293	16.3

TABLE 1.4

MID-SIZED MALE STANDARD ANTHROPOMETRY
(Descriptive Statistics, cm or as noted)

Measurement Variable	N	Min.	Max.	Mean	S.D.
Age (years)	25	20.0	61.0	38.1	12.2
Stature	25	171.2	178.6	175.1	2.1
Weight (kg)	25	70.0	83.6	76.7	3.5
Sitting Height (erect)	25	87.2	95.0	91.1	2.3
Buttock-Knee Length	25	55.9	62.6	59.3	2.1
Cervicale Height	25	145.6	153.8	149.8	2.2
Trochanterion Height	25	84.0	95.7	90.5	2.3
Tibiale Height	25	45.0	51.8	48.3	1.9
Head Breadth	25	14.4	16.9	15.8	0.6
Head Length	25	18.8	21.4	19.7	0.7
Head Height	25	21.8	24.9	23.1	0.8
Shoulder Breadth	25	41.3	47.6	44.9	1.7
Biacromial Breadth	25	35.7	43.2	39.5	1.9
Clavicale Length	25	16.6	19.9	18.3	0.9
Suprasternale-Cerv. Dist.	25	11.6	13.8	12.6	0.6
Bispinous Breadth	25	18.7	27.7	22.5	1.9
Acromion-Radiale Length	25	30.8	35.1	32.9	1.2
Shoulder-Elbow Length	25	32.6	38.5	36.5	1.3
Elbow-Hand Length	25	44.5	49.7	47.4	1.3
Radius Length	25	24.8	29.1	26.9	1.1
Hand Breadth	25	7.6	10.2	8.5	0.6
Hand Length	25	17.6	19.5	18.7	0.5
Troch.-to-Lat. Fem. Condyle	25	38.4	46.2	43.5	2.0
Tibia Length	25	36.2	44.3	40.2	2.2
Foot Breadth	25	8.4	10.8	9.6	0.5
Foot Length	25	24.6	27.8	26.4	0.8
Head Circumference	25	53.3	60.9	57.1	1.9
Shoulder Circumference	25	102.3	120.0	111.5	5.3
Chest Circumference (axilla)	25	91.0	104.5	97.3	3.2
Chest Circumference (nipple)	25	89.3	102.5	96.1	3.6
Waist Circumference	25	77.2	94.7	85.9	5.2
Hip Circumference	25	87.3	101.5	94.4	3.1
Upper Arm Circumference (biceps)	25	24.6	35.0	29.9	2.0
Forearm Circumference	25	21.8	28.6	25.4	1.7
Thigh Circumference (mid)	25	45.7	57.3	51.5	3.2
Calf Circumference	25	33.8	39.8	36.7	1.7
Skinfold, Subscapular (mm)	25	10.0	30.0	15.1	4.5
Skinfold, Triceps (mm)	25	4.0	25.0	10.0	6.2
Skinfold, Suprailiac (mm)	25	7.0	37.0	21.1	8.0
Skinfold, Posterior Mid-Calf (mm)	25	3.0	20.0	9.9	5.1

TABLE 1.5

MID-SIZED MALE CONTOURED HARDSEAT ANTHROPOMETRY
(Descriptive Statistics, cm or as noted)

Measurement Variable	N	Min.	Max.	Mean	S.D.
Sitting Height	25	97.0	104.4	100.3	1.8
Cervicale Height	25	72.1	78.5	75.3	1.7
Chin Height	25	73.7	81.8	77.4	2.3
Neck Length (anterior)	25	5.8	10.7	8.5	1.5
Neck Breadth (mid)	25	10.4	12.9	11.4	0.6
Neck Depth (mid)	25	10.4	12.9	11.5	0.7
Neck Circumference (mid)	25	35.8	41.6	38.3	1.4
Neck Breadth (lower)	25	11.1	13.6	12.2	0.7
Neck Depth (lower)	25	10.6	12.7	11.5	0.6
Neck Circumference (lower)	25	37.0	42.0	39.3	1.3
Shoulder Height (mid)	25	69.1	75.2	72.1	1.5
Acromion Height	25	65.5	71.3	68.3	1.8
Clav.-to-Acr. Clavic. Artic	25	15.9	18.7	17.4	0.8
Shoulder Breadth	25	42.5	48.9	46.8	1.5
Shoulder Circumference	25	113.9	126.8	119.9	3.5
Biacromial Breadth	23	38.5	42.7	40.7	1.2
Torso Depth (upper)	25	10.1	14.6	11.9	1.2
Shoulder Depth (scye)	25	12.9	16.5	14.5	1.0
Axillary Depth	25	9.9	13.9	11.7	1.0
Arm Angle (upper)	25	29.0°	52.0°	40.4°	6.0
Arm Angle (lower)	25	28.0°	42.0°	35.9°	3.9
Right-Left Med. Hum. Epicondyle	25	30.6	38.1	33.8	2.2
Right-Left Stylium	25	23.6	30.2	27.0	1.7
Arm Circumference (scye)	25	41.7	51.4	45.3	2.5
Arm Breadth (upper)	25	7.3	9.6	8.6	0.6
Arm Depth (upper)	25	7.6	13.3	10.8	1.0
Arm Circumference (upper)	25	29.0	35.0	31.5	1.7
Arm Breadth (above elbow)	25	7.2	9.2	8.3	0.6
Arm Depth (above elbow)	25	7.2	9.1	8.2	0.5
Arm Circumference (above elbow)	25	25.9	31.1	28.4	1.5
Olecranon Height	25	41.2	48.2	45.0	2.0
Elbow Breadth	25	7.1	8.9	8.0	0.4
Elbow Depth	25	8.1	9.8	9.2	0.4
Elbow Circumference	25	26.2	30.3	28.5	1.1
Forearm Breadth (upper)	25	7.2	9.1	8.2	0.5
Forearm Depth (upper)	25	7.9	9.5	8.6	0.5
Forearm Circumference (upper)	25	25.5	30.4	27.5	1.3
Forearm Circumference (lower)	25	16.0	20.6	18.3	1.2
Wrist Breadth (condyles)	25	5.4	6.7	5.9	0.3
Wrist Depth (condyles)	25	3.8	5.1	4.1	0.3
Wrist Circumference (condyles)	25	15.7	18.3	16.9	0.6

TABLE 1.5
HARDSEAT ANTHROPOMETRY STATISTICS: MID-SIZED MALE (Continued)

Measurement Variable	N	Min.	Max.	Mean	S.D.
Chest Height (nipple)	25	52.1	60.4	55.4	2.1
Chest Height (posterior scye)	25	54.4	59.9	57.0	1.6
Chest Breadth (axilla)	25	27.8	32.8	30.4	1.1
Chest Circumference (axilla)	25	99.2	111.2	103.9	3.2
Chest Breadth (nipple)	25	32.5	38.3	34.9	1.6
Chest Circumference (nipple)	25	95.4	105.5	101.0	3.1
Chest Circumference (10th rib)	25	80.2	99.3	90.9	5.2
Waist Breadth (umbilicus)	25	27.7	35.1	31.4	2.1
Waist Depth (umbilicus)	25	20.0	27.7	24.4	1.8
Waist Circumference (umbilicus)	25	80.0	97.1	90.4	5.1
Abdominal Breadth (maximum)	25	29.4	35.9	32.5	1.8
Abdominal Depth (maximum)	25	22.8	30.3	26.9	2.0
Abdominal Circumference (max.)	25	80.2	99.2	91.3	5.3
Iliocristale Height	25	34.4	37.3	35.7	0.8
Thigh-Abdom. Junct. Height	25	33.1	36.2	34.5	0.9
Ant.-Sup. Iliac Spine Height	25	32.9	36.7	34.7	0.9
Trochanterion Height	25	27.6	30.9	29.2	1.0
Hip Breadth (max.)	25	34.6	41.0	38.5	1.8
Bitrochanter Breadth	25	30.6	38.8	32.9	1.7
Leg Angle (upper)	25	10.0°	24.0°	18.1°	4.3
Leg Angle (lower)	25	42.0°	58.0°	52.6°	3.5
Right-Left Med. Fem. Epicondyle	25	9.2	27.0	17.4	4.4
Right-Left Sphyrion	25	10.7	14.9	12.2	1.1
Troc.-to-Lat. Fem. Condyle	23	41.4	48.8	44.7	1.8
Thigh Breadth (upper)	25	16.2	22.4	19.4	1.3
Thigh Circumference (upper)	25	53.4	64.0	57.9	3.1
Thigh Breadth (mid)	25	13.2	17.5	15.5	1.2
Thigh Circumference (mid)	25	44.2	55.0	50.4	3.0
Knee Height	25	40.9	48.2	45.3	2.3
Knee Breadth	25	9.2	11.0	10.1	0.5
Knee Depth (popliteal)	25	12.2	14.0	13.2	0.6
Knee Circumference	25	36.3	41.9	39.2	1.4
Calf Breadth	25	9.4	11.8	11.0	0.6
Calf Depth	25	10.8	12.6	11.8	0.6
Calf Circumference	25	33.5	39.5	37.3	1.6
Ankle Breadth (min.)	25	5.2	7.7	6.1	0.6
Ankle Depth (min.)	25	7.0	9.2	7.6	0.5
Ankle Circumference (min.)	25	21.0	28.4	22.9	1.7
Ankle Breadth (condyles)	25	6.7	8.0	7.3	0.3
Ankle Depth (condyles)	25	8.1	10.4	9.4	0.5
Ankle Circumference (condyles)	25	24.5	28.4	26.1	1.1

TABLE 1.6

MID-SIZED MALE SURFACE LANDMARK LABORATORY COORDINATES
(Descriptive Statistics, mm)

Reference No. and Landmark	Coord	N	Min.	Max.	Mean	S.D.
HEAD AND NECK:						
1. Glabella	X	25	517	629	577	28.9
	Y	25	597	653	619	11.8
	Z	25	1023	1112	1073	21.5
2. Infraorbitale	X	25	500	609	561	28.3
	Y	25	632	682	653	11.1
	Z	25	999	1081	1042	20.5
3. Tragon	X	24	412	509	472	26.0
	Y	24	680	725	702	11.3
	Z	24	1004	1069	1036	17.9
4. Gonion	X	18	438	527	484	28.8
	Y	18	677	712	689	9.2
	Z	18	938	1003	966	19.6
5. Gnathion	X	16	507	597	556	27.9
	Y	16	603	646	619	12.4
	Z	16	903	971	933	21.3
SPINE AND SCAPULA:						
7. C7	X	25	347	424	391	23.0
	Y	25	607	639	619	8.7
	Z	25	878	944	911	17.2
8. T4	X	25	346	379	364	10.9
	Y	25	608	640	619	7.8
	Z	25	757	841	802	20.6
9. T8	X	25	357	393	373	7.4
	Y	25	609	631	619	6.2
	Z	25	616	746	675	24.7
10. T12	X	25	381	437	411	12.3
	Y	25	609	634	619	6.4
	Z	25	524	618	568	23.2
11. L2	X	25	420	468	440	12.2
	Y	25	607	632	619	6.3
	Z	25	474	539	509	18.4
12. L5	X	25	454	500	483	10.9
	Y	25	610	630	619	5.5
	Z	25	410	465	435	14.1

TABLE 1.6
 LANDMARK LABORATORY COORDINATE STATISTICS: MID-SIZED MALE (Continued)

Reference No. and Landmark	Coord	N	Min.	Max.	Mean	S.D.
SPINE AND SCAPULA (Continued)						
13. 10th Rib, mid-spine . . .	X	25	401	433	415	8.1
	Y	25	610	633	619	6.4
	Z	25	535	589	560	14.5
14. Scapula, Sup. Marg . . .	X	25	337	380	361	12.9
	Y	25	664	722	698	15.7
	Z	25	778	867	825	19.0
15. Scapula, Inf. Marg . . .	X	25	360	398	381	10.5
	Y	25	721	764	745	11.1
	Z	25	650	725	689	16.1
CHEST AND TORSO:						
18. Suprasternale	X	25	482	547	518	19.4
	Y	25	609	636	619	7.5
	Z	25	834	890	857	14.4
19. Mesosternale	X	25	517	594	559	17.6
	Y	25	603	638	619	8.1
	Z	25	770	841	807	17.5
20. Substernale	X	25	549	613	585	14.7
	Y	25	608	639	619	7.9
	Z	25	721	787	758	19.8
21. Bimammary Midline	X	25	571	637	605	15.0
	Y	25	605	637	619	7.5
	Z	25	677	744	703	19.2
22. Nipple	X	25	574	639	605	14.9
	Y	25	711	746	732	9.6
	Z	25	678	754	712	19.8
23. 10th Rib, Ant. Midline .	X	25	632	704	672	16.9
	Y	25	606	638	619	8.0
	Z	25	583	631	613	10.8
24. Umbilicus	X	25	660	722	692	16.6
	Y	25	606	632	619	7.1
	Z	25	554	589	575	7.8
25. Max. Abdom. Protrusion .	X	25	680	742	713	16.4
	Y	25	606	634	619	7.6
	Z	25	531	573	551	10.6
26. 10th Rib	X	24	541	603	564	16.9
	Y	24	759	802	775	11.2
	Z	24	531	586	556	13.7

TABLE 1.6
 LANDMARK LABORATORY COORDINATE STATISTICS: MID-SIZED MALE (Continued)

Reference No. and Landmark	Coord	N	Min.	Max.	Mean	S.D.
PELVIS AND HIP:						
27. Iliocristale	X	25	552	618	577	20.0
	Y	25	750	802	780	11.9
	Z	25	502	531	515	7.4
28. Ant. Sup. Iliac Spine . .	X	25	616	657	632	10.0
	Y	25	705	756	735	12.0
	Z	25	489	531	505	9.8
29. Pubic Symphysis	X	25	687	727	708	11.5
	Y	25	605	635	619	7.8
	Z	25	443	487	463	10.5
30. Thigh-Abdom. Junction . .	X	23	662	691	678	8.8
	Y	23	716	761	741	9.4
	Z	23	494	522	503	7.4
31a. Trochanterion (palpated)	X	25	605	647	624	12.0
	Y	25	783	826	807	10.7
	Z	25	435	463	450	7.8
31b. Trochanterion (reconstr.)	X	--	---	---	677	---
	Y	--	---	---	822	---
	Z	--	---	---	402	---
SHOULDER:						
33. Clavicale	X	25	470	550	512	21.9
	Y	25	631	661	642	8.8
	Z	25	841	902	865	14.8
34. Acr.-Clav. Artic	X	25	402	476	442	20.1
	Y	25	786	820	801	9.5
	Z	25	835	891	865	15.6
35. Gr. Tubercle Humerus . .	X	25	446	519	484	20.6
	Y	25	821	853	837	9.2
	Z	25	814	869	843	16.7
36. Acromion	X	25	396	459	433	18.9
	Y	25	804	844	822	10.3
	Z	25	809	872	841	17.2
37. Scye, anterior	X	24	526	585	560	16.6
	Y	24	761	791	773	9.1
	Z	24	766	841	802	16.3
38. Scye, posterior	X	23	422	457	443	10.9
	Y	23	795	835	816	11.5
	Z	23	693	758	728	17.3

TABLE 1.6
 LANDMARK LABORATORY COORDINATE STATISTICS: MID-SIZED MALE (Continued)

Reference No. and Landmark	Coord	N	Min.	Max.	Mean	S.D.
ARM AND HAND:						
39. Lat. Humeral Epicondyle .	X	25	661	712	689	16.0
	Y	25	828	885	861	14.7
	Z	25	602	696	646	23.8
40. Radiale	X	25	668	728	703	16.8
	Y	25	827	886	862	14.5
	Z	25	590	679	631	23.5
41. Med. Humeral Epicondyle .	X	25	644	712	689	17.3
	Y	25	763	824	792	14.6
	Z	25	582	663	621	21.2
42. Olecranon	X	25	670	732	710	16.2
	Y	25	799	860	829	16.2
	Z	25	569	657	608	23.4
43. Ulnar Styloid	X	25	862	899	883	8.9
	Y	25	794	832	810	10.1
	Z	25	783	839	809	15.3
44. Stylion	X	25	855	880	868	6.7
	Y	25	735	773	754	10.9
	Z	25	793	851	821	16.6
LEG AND FOOT:						
45. Lat. Femoral Condyle . .	X	25	1042	1082	1061	9.4
	Y	25	767	842	808	17.8
	Z	25	501	581	551	22.6
46. Med. Femoral Epicondyle .	X	25	1041	1087	1064	10.8
	Y	25	672	738	706	17.4
	Z	25	522	606	564	23.8
47. Tibiale	X	25	1057	1099	1081	11.0
	Y	25	673	741	707	17.1
	Z	25	505	590	550	22.7
48. Patella	X	21	1073	1131	1106	14.2
	Y	21	725	816	769	20.4
	Z	21	558	633	594	21.4
49. Sphyrion	X	25	1333	1355	1341	6.2
	Y	25	665	698	680	6.6
	Z	25	261	286	273	6.0
50. Metatarsal/Phalangeal I .	X	25	1445	1462	1453	4.9
	Y	25	684	720	703	9.1
	Z	25	324	351	336	7.0

TABLE 1.6
 LANDMARK LABORATORY COORDINATE STATISTICS: MID-SIZED MALE (Continued)

Reference No. and Landmark	Coord	N	Min.	Max.	Mean	S.D.
LEG AND FOOT (Continued)						
51. Digit II	X	25	1484	1506	1496	5.4
	Y	25	741	788	766	12.3
	Z	25	370	401	385	9.0
52. Metatarsal/Phalangeal V .	X	25	1428	1455	1442	6.2
	Y	25	779	806	793	7.1
	Z	25	283	320	298	9.0
53. Lateral Malleolus	X	25	1323	1353	1337	7.7
	Y	25	732	761	745	7.4
	Z	25	227	252	237	7.0
ANTHRO. MEASUREMENT POINTS						
93. Neck, mid	X	24	406	504	459	26.2
	Y	24	664	693	676	8.3
	Z	24	903	958	934	16.5
94. Neck, lower	X	24	405	497	453	24.2
	Y	24	666	697	680	8.2
	Z	24	885	941	914	14.9
95. Arm, upper	X	23	517	586	552	18.5
	Y	23	838	863	850	7.7
	Z	23	719	791	758	17.9
96. Forearm, upper	X	24	742	799	767	13.6
	Y	24	829	872	853	12.4
	Z	24	670	744	703	20.6
97. Forearm, lower	X	24	817	872	848	13.7
	Y	24	800	843	816	12.2
	Z	24	743	804	775	17.5
98. Thigh, upper	X	25	686	828	788	26.9
	Y	25	791	834	816	9.9
	Z	25	449	511	482	11.3
99. Thigh, mid	X	25	821	929	883	19.2
	Y	25	799	845	817	12.1
	Z	25	490	540	511	12.8
100. Calf	X	25	1154	1192	1168	10.7
	Y	25	776	824	799	10.3
	Z	25	380	448	416	18.2
101. Ankle	X	25	1258	1309	1281	14.2
	Y	25	736	771	752	8.3
	Z	25	283	323	300	11.5

TABLE 1.7

LARGE MALE STANDARD ANTHROPOMETRY
(Descriptive Statistics, cm or as noted)

Measurement Variable	N	Min.	Max.	Mean	S.D.
Age (years)	25	19.0	55.0	36.6	10.3
Stature	25	182.5	191.8	186.4	2.4
Weight (kg)	25	94.5	112.7	102.6	5.0
Sitting Height (erect)	25	92.2	101.2	97.1	2.6
Buttock-Knee Length	25	59.6	67.8	63.8	1.9
Cervicale Height	24	156.0	165.6	160.2	2.4
Trochanterion Height	25	91.9	99.5	95.6	2.0
Tibiale Height	25	51.2	57.2	54.1	1.6
Head Breadth	25	13.9	16.6	15.6	0.7
Head Length	25	18.1	21.8	20.2	0.9
Head Height	25	21.2	25.3	23.3	0.9
Shoulder Breadth	25	44.8	52.1	48.2	2.1
Biacromial Breadth	25	38.2	45.8	42.3	1.7
Clavicale Length	24	19.0	22.0	20.7	0.6
Suprasternale-Cerv. Dist.	25	12.1	15.9	14.3	1.0
Bispinous Breadth	24	23.6	28.7	25.2	1.3
Acromion-Radiale Length	25	33.8	37.1	35.5	1.0
Shoulder-Elbow Length	24	35.0	41.2	38.2	1.3
Elbow-Hand Length	25	48.4	52.8	50.2	1.0
Radius Length	25	26.9	30.4	28.6	0.9
Hand Breadth	25	8.3	9.8	9.0	0.3
Hand Length	24	19.2	20.7	19.7	0.4
Troch.-to-Lat. Fem. Condyle	25	43.7	50.6	46.8	1.7
Tibia Length	24	43.5	47.6	45.2	1.1
Foot Breadth	25	9.3	12.0	10.7	0.6
Foot Length	25	26.5	29.8	28.2	0.9
Head Circumference	24	55.0	62.4	59.4	1.5
Shoulder Circumference	25	115.4	138.3	126.4	5.4
Chest Circumference (axilla)	25	99.2	118.5	108.0	4.6
Chest Circumference (nipple)	25	98.0	119.0	109.8	5.0
Waist Circumference	25	96.4	117.0	103.3	5.1
Hip Circumference	25	97.0	112.6	105.7	3.7
Upper Arm Circumference (biceps)	25	27.7	37.5	32.7	2.2
Forearm Circumference	25	25.5	31.3	28.2	1.3
Thigh Circumference (mid)	25	47.7	63.5	55.7	3.6
Calf Circumference	25	37.0	43.4	40.4	1.9
Skinfold, Subscapular (mm)	25	11.0	37.0	26.6	6.4
Skinfold, Triceps (mm)	25	7.0	26.0	16.3	5.6
Skinfold, Suprailiac (mm)	25	16.0	45.0	33.9	6.5
Skinfold, Posterior Mid-Calf (mm)	25	6.0	26.0	16.7	5.9

TABLE 1.8

LARGE MALE CONTOURED HARDSEAT ANTHROPOMETRY
(Descriptive Statistics, cm or as noted)

Measurement Variable	N	Min.	Max.	Mean	S.D.
Sitting Height	25	99.3	105.4	102.9	1.8
Cervicale Height	25	75.3	81.1	78.2	1.7
Chin Height	25	77.3	84.1	80.6	1.9
Neck Length (anterior)	25	7.4	11.7	9.8	1.1
Neck Breadth (mid)	25	11.5	14.1	12.6	0.8
Neck Depth (mid)	25	11.6	13.7	12.6	0.6
Neck Circumference (mid)	25	37.8	45.1	42.1	1.9
Neck Breadth (lower)	25	12.0	15.0	13.6	0.8
Neck Depth (lower)	25	11.3	14.5	13.1	0.8
Neck Circumference (lower)	25	38.6	47.5	43.3	2.3
Shoulder Height (mid)	25	71.8	77.2	74.7	1.5
Acromion Height	25	66.3	75.4	70.5	2.3
Clav.-to-Acr. Clavic. Artic	24	17.2	20.7	19.1	1.1
Shoulder Breadth	25	45.7	56.1	50.2	2.6
Shoulder Circumference	25	122.8	145.8	131.7	5.8
Biacromial Breadth	25	36.5	47.0	43.4	2.3
Torso Depth (upper)	25	11.1	15.5	13.8	1.1
Shoulder Depth (scye)	25	15.1	19.3	16.8	1.2
Axillary Depth	25	11.1	15.7	13.3	1.0
Arm Angle (upper)	25	26.0°	50.0°	36.7°	5.9
Arm Angle (lower)	25	12.0°	38.0°	23.9°	7.0
Right-Left Med. Hum. Epicondyle	25	31.9	45.2	37.8	3.1
Right-Left Stylium	25	23.6	32.7	27.6	2.4
Arm Circumference (scye)	25	46.2	55.3	50.6	2.3
Arm Breadth (upper)	25	8.0	11.3	9.8	0.7
Arm Depth (upper)	25	10.6	14.3	12.5	1.0
Arm Circumference (upper)	25	31.1	40.2	35.8	2.1
Arm Breadth (above elbow)	25	8.0	10.9	9.2	0.9
Arm Depth (above elbow)	25	8.0	10.8	9.2	0.7
Arm Circumference (above elbow)	25	27.8	37.3	31.3	2.3
Olecranon Height	25	42.7	52.5	47.6	3.0
Elbow Breadth	25	7.6	10.0	8.5	0.6
Elbow Depth	25	8.7	11.0	9.5	0.6
Elbow Circumference	25	28.2	33.9	30.4	1.5
Forearm Breadth (upper)	25	7.8	9.7	8.5	0.5
Forearm Depth (upper)	25	8.1	11.1	9.2	0.7
Forearm Circumference (upper)	25	27.5	33.2	29.6	1.4
Forearm Circumference (lower)	25	17.0	23.5	20.3	1.6
Wrist Breadth (condyles)	25	5.8	6.6	6.2	0.2
Wrist Depth (condyles)	25	4.2	5.3	4.5	0.3
Wrist Circumference (condyles)	25	17.2	19.0	18.1	0.5

TABLE 1.8
HARDSEAT ANTHROPOMETRY STATISTICS: LARGE MALE (Continued)

Measurement Variable	N	Min.	Max.	Mean	S.D.
Chest Height (nipple)	25	52.8	61.1	57.1	2.4
Chest Height (posterior scye) .	25	54.7	61.3	57.9	1.9
Chest Breadth (axilla)	25	28.5	36.3	32.3	1.8
Chest Circumference (axilla) .	25	107.1	125.4	117.1	5.5
Chest Breadth (nipple)	25	34.0	44.4	38.4	2.5
Chest Circumference (nipple) .	25	105.4	128.5	115.9	5.3
Chest Circumference (10th rib)	25	92.5	120.8	106.5	6.9
Waist Breadth (umbilicus) . . .	25	32.8	40.2	36.1	2.0
Waist Depth (umbilicus)	25	21.7	37.0	30.1	3.5
Waist Circumference (umbilicus)	25	94.0	121.6	107.5	6.8
Abdominal Breadth (maximum) . .	25	35.8	42.3	38.4	1.8
Abdominal Depth (maximum) . . .	25	27.1	37.9	31.6	3.0
Abdominal Circumference (max.)	25	99.2	121.7	108.2	6.4
Iliocristale Height	25	33.4	39.5	35.4	1.5
Thigh-Abdom. Junct. Height . .	25	32.8	36.8	34.5	1.2
Ant.-Sup. Iliac Spine Height .	25	33.2	37.2	34.9	1.1
Trochanterion Height	25	26.4	30.6	28.4	1.1
Hip Breadth (max.)	25	40.7	48.5	43.9	2.2
Bitrochanter Breadth	25	33.4	44.4	38.5	2.3
Leg Angle (upper)	25	12.0°	24.0°	19.1°	3.3
Leg Angle (lower)	25	47.0°	56.0°	51.7°	2.8
Right-Left Med. Fem. Epicondyle	25	12.4	27.9	19.6	4.5
Right-Left Sphyrion	25	9.8	15.5	12.6	1.5
Troc.-to-Lat. Fem. Condyle . .	24	43.0	51.1	46.6	2.0
Thigh Breadth (upper)	25	18.7	24.8	21.4	1.6
Thigh Circumference (upper) . .	25	56.8	69.7	63.9	3.3
Thigh Breadth (mid)	25	13.9	19.0	16.9	1.2
Thigh Circumference (mid) . . .	25	48.5	63.5	55.9	3.5
Knee Height	25	43.3	52.2	47.8	2.0
Knee Breadth	25	10.3	12.3	11.1	0.5
Knee Depth (popliteal)	25	13.2	16.1	14.5	0.7
Knee Circumference	25	40.5	45.6	43.4	1.3
Calf Breadth	25	10.8	14.0	12.1	0.8
Calf Depth	25	11.7	13.8	12.8	0.5
Calf Circumference	25	37.2	44.2	40.6	1.9
Ankle Breadth (min.)	25	5.5	7.7	6.6	0.6
Ankle Depth (min.)	23	7.2	9.0	8.2	0.5
Ankle Circumference (min.) . .	24	21.2	28.3	24.7	1.8
Ankle Breadth (condyles) . . .	25	6.6	8.5	7.7	0.4
Ankle Depth (condyles)	25	9.1	11.2	10.2	0.6
Ankle Circumference (condyles)	24	26.2	31.2	28.7	1.2

TABLE 1.9

LARGE MALE SURFACE LANDMARK LABORATORY COORDINATES
(Descriptive Statistics, mm)

Reference No. and Landmark	Coord.	N	Min.	Max.	Mean	S.D.
HEAD AND NECK:						
1. Glabella	X	25	453	576	507	28.7
	Y	25	583	644	619	17.3
	Z	25	1060	1143	1093	18.7
2. Infraorbitale	X	25	440	559	490	27.5
	Y	25	622	680	656	16.2
	Z	25	1024	1102	1059	17.4
3. Tragion	X	24	362	478	406	27.7
	Y	24	660	729	702	18.4
	Z	24	1023	1096	1055	16.4
4. Gonion	X	23	383	481	423	24.8
	Y	23	650	721	689	18.7
	Z	23	951	1019	985	18.2
5. Gnathion	X	23	473	566	510	23.8
	Y	23	580	648	619	17.9
	Z	23	923	1004	964	19.5
SPINE AND SCAPULA:						
7. C7	X	25	284	352	318	18.4
	Y	25	586	642	619	15.1
	Z	25	907	982	940	18.2
8. T4	X	25	263	306	285	11.3
	Y	25	593	639	619	12.3
	Z	25	788	872	830	22.8
9. T8	X	25	279	313	291	8.3
	Y	25	607	629	619	5.6
	Z	25	636	746	693	25.0
10. T12	X	25	306	356	335	12.9
	Y	25	610	630	619	6.0
	Z	25	537	605	564	18.4
11. L2	X	24	344	391	372	12.7
	Y	24	609	635	619	6.4
	Z	24	475	544	504	20.1
12. L5	X	25	395	434	416	13.1
	Y	25	606	633	619	6.4
	Z	25	387	456	428	20.1

TABLE 1.9
LANDMARK LABORATORY COORDINATE STATISTICS: LARGE MALE (Continued)

Reference No. and Landmark	Coord.	N	Min.	Max.	Mean	S.D.
SPINE AND SCAPULA (Continued)						
13. 10th Rib, mid-spine . . .	X	24	318	364	341	11.2
	Y	24	609	630	619	6.4
	Z	24	522	580	553	16.4
14. Scapula, Sup. Marg . . .	X	25	267	309	287	10.9
	Y	25	671	733	702	18.7
	Z	25	831	890	855	15.2
15. Scapula, Inf. Marg . . .	X	25	288	345	317	12.2
	Y	25	733	793	766	16.0
	Z	25	646	714	680	15.6
CHEST AND TORSO:						
18. Suprasternale	X	25	426	485	456	15.7
	Y	25	596	638	619	10.5
	Z	25	840	904	868	17.0
19. Mesosternale	X	25	472	522	499	13.5
	Y	25	598	639	619	11.8
	Z	25	783	872	824	19.3
20. Substernale	X	25	507	554	529	13.6
	Y	25	602	635	619	9.1
	Z	25	736	824	773	20.9
21. Bimammary Midline	X	25	524	592	558	15.5
	Y	25	606	634	619	8.4
	Z	25	678	760	721	22.0
22. Nipple	X	25	529	587	559	14.6
	Y	25	732	777	751	12.1
	Z	25	678	768	729	22.2
23. 10th Rib, Ant. Midline .	X	22	587	691	651	29.8
	Y	21	610	631	619	6.1
	Z	22	593	661	627	19.3
24. Umbilicus	X	25	619	726	678	30.3
	Y	25	603	635	619	6.2
	Z	25	557	604	581	11.8
25. Max. Abdom. Protrusion .	X	25	638	748	693	29.4
	Y	25	603	631	619	5.7
	Z	25	541	582	562	11.6
26. 10th Rib	X	25	474	509	492	9.6
	Y	25	791	831	813	10.9
	Z	25	519	585	552	16.3

TABLE 1.9
 LANDMARK LABORATORY COORDINATE STATISTICS: LARGE MALE (Continued)

Reference No. and Landmark	Coord.	N	Min.	Max.	Mean	S.D.
PELVIS AND HIP:						
27. Iliocristale	X	25	480	523	504	9.8
	Y	25	800	837	816	9.6
	Z	25	491	551	514	14.8
28. Ant. Sup. Iliac Spine . .	X	25	574	624	591	13.2
	Y	25	726	754	740	7.6
	Z	25	486	525	507	10.4
29. Pubic Symphysis	X	25	641	688	668	13.3
	Y	25	603	633	619	6.7
	Z	25	434	476	459	9.9
30. Thigh-Abdom. Junction . .	X	23	621	661	637	14.4
	Y	23	753	792	774	10.3
	Z	23	490	520	503	9.9
31a. Trochanterion (palpated)	X	25	561	607	584	12.2
	Y	25	820	860	836	10.4
	Z	25	424	462	442	8.7
31b. Trochanterion (reconstr.)	X	--	---	---	640	---
	Y	--	---	---	834	---
	Z	--	---	---	387	---
SHOULDER:						
33. Clavicale	X	25	420	478	447	15.9
	Y	25	616	666	644	13.1
	Z	25	855	919	882	15.2
34. Acr.-Clav. Artic	X	25	318	417	371	20.9
	Y	25	774	844	811	17.0
	Z	25	852	933	889	18.8
35. Gr. Tubercle Humerus . .	X	24	377	463	433	20.8
	Y	23	824	859	842	11.5
	Z	24	842	912	878	17.4
36. Acromion	X	24	334	399	362	17.5
	Y	25	805	868	836	15.0
	Z	25	828	902	863	20.0
37. Scye, anterior	X	25	457	536	503	18.4
	Y	25	761	816	786	13.3
	Z	25	781	869	830	21.3
38. Scye, posterior	X	24	329	392	373	13.9
	Y	24	813	866	840	15.9
	Z	24	705	774	737	19.4

TABLE 1.9
 LANDMARK LABORATORY COORDINATE STATISTICS: LARGE MALE (Continued)

Reference No. and Landmark	Coord.	N	Min.	Max.	Mean	S.D.
ARM AND HAND:						
39. Lat. Humeral Epicondyle .	X	25	626	681	652	15.0
	Y	25	847	925	885	19.4
	Z	25	631	747	679	29.5
40. Radiale	X	25	643	707	670	16.0
	Y	25	839	925	880	21.3
	Z	25	608	732	661	29.6
41. Med. Humeral Epicondyle .	X	25	610	676	645	15.9
	Y	25	762	853	808	21.5
	Z	25	595	696	645	24.9
42. Olecranon	X	25	624	697	666	18.8
	Y	25	814	901	853	22.1
	Z	25	583	698	634	27.9
43. Ulnar Styloid	X	25	866	897	880	9.0
	Y	25	789	842	816	14.0
	Z	25	778	842	807	18.3
44. Stylium	X	24	850	875	863	8.4
	Y	24	726	793	757	16.7
	Z	24	791	866	823	17.2
LEG AND FOOT:						
45. Lat. Femoral Condyle . .	X	25	1004	1052	1029	12.2
	Y	25	776	881	826	25.5
	Z	25	514	607	566	22.7
46. Med. Femoral Epicondyle .	X	25	1005	1055	1032	11.6
	Y	25	667	783	717	26.7
	Z	25	552	627	584	15.9
47. Tibiale	X	25	1022	1069	1051	11.2
	Y	25	668	778	716	25.8
	Z	25	545	614	572	15.6
48. Patella	X	25	1045	1112	1078	14.9
	Y	25	730	853	787	29.0
	Z	25	560	651	611	20.9
49. Sphyrion	X	25	1319	1356	1339	8.7
	Y	25	668	698	682	7.7
	Z	25	268	288	278	5.8
50. Metatarsal/Phalangeal I .	X	25	1444	1478	1463	7.6
	Y	25	691	728	707	8.9
	Z	25	322	354	339	7.8

TABLE 1.9
 LANDMARK LABORATORY COORDINATE STATISTICS: LARGE MALE (Continued)

Reference No. and Landmark	Coord.	N	Min.	Max.	Mean	S.D.
LEG AND FOOT (Continued)						
51. Digit II	X	24	1487	1516	1507	7.1
	Y	24	747	799	769	11.4
	Z	24	377	410	392	8.6
52. Metatarsal/Phalangeal V .	X	25	1437	1465	1450	6.4
	Y	25	789	812	803	5.8
	Z	25	289	326	304	9.6
53. Lateral Malleolus	X	25	1311	1339	1329	6.8
	Y	25	739	767	754	6.3
	Z	25	231	251	240	5.2
ANTHRO. MEASUREMENT POINTS						
93. Neck, mid	X	25	358	437	392	20.2
	Y	25	648	707	682	14.9
	Z	25	912	994	953	17.4
94. Neck, lower	X	25	351	426	385	19.5
	Y	25	654	713	687	14.1
	Z	25	890	968	929	17.0
95. Arm, upper	X	25	478	531	508	15.8
	Y	25	840	892	872	13.1
	Z	25	743	829	786	23.4
96. Forearm, upper	X	25	714	759	740	11.8
	Y	25	836	909	871	17.8
	Z	25	690	768	727	23.1
97. Forearm, lower	X	25	792	860	834	16.6
	Y	25	803	855	830	13.0
	Z	25	736	820	781	21.9
98. Thigh, upper	X	25	704	812	751	22.9
	Y	25	825	865	844	11.1
	Z	25	463	528	489	13.2
99. Thigh, mid	X	25	820	884	842	18.2
	Y	25	811	878	843	15.4
	Z	25	495	570	521	18.7
100. Calf	X	25	1125	1175	1150	11.8
	Y	25	783	853	818	16.3
	Z	25	382	454	427	18.7
101. Ankle	X	25	1254	1303	1281	11.6
	Y	25	747	788	762	10.9
	Z	25	271	332	298	15.8

APPENDIX J

PHOTOGRAPHS OF CLAY MODEL DEVELOPMENT AND EPOXY/FIBERGLASS SHELL FABRICATION

The following pages show the progression of steps involved in developing the clay models, making the plaster molds, and fabricating and finishing the epoxy/fiberglass surface shells for each of the three dummy/family members. As described in the text (Section 4), the mid-sized male clay model was developed with different procedures than the small female and large male models. Figure J-1 shows the process of assembling the adjustable skeletal armature while Figures J-2 and J-3 show the sculpting of the clay model with Plasticine clay and fabrication of the plaster mold and surface shell for the mid-sized male dummy form. Figures J-4 through J-8 show similar steps for the large male and small female models and the shells for which a welded steel armature and industrial styling clay were used in the model development. Figure J-9 shows the final finishing, smoothing, and painting of the assembled surface shells.



FIGURE J-1. Constructing and sculpting the mid-sized male clay model using a "skeletal" armature and Plasticine clay.

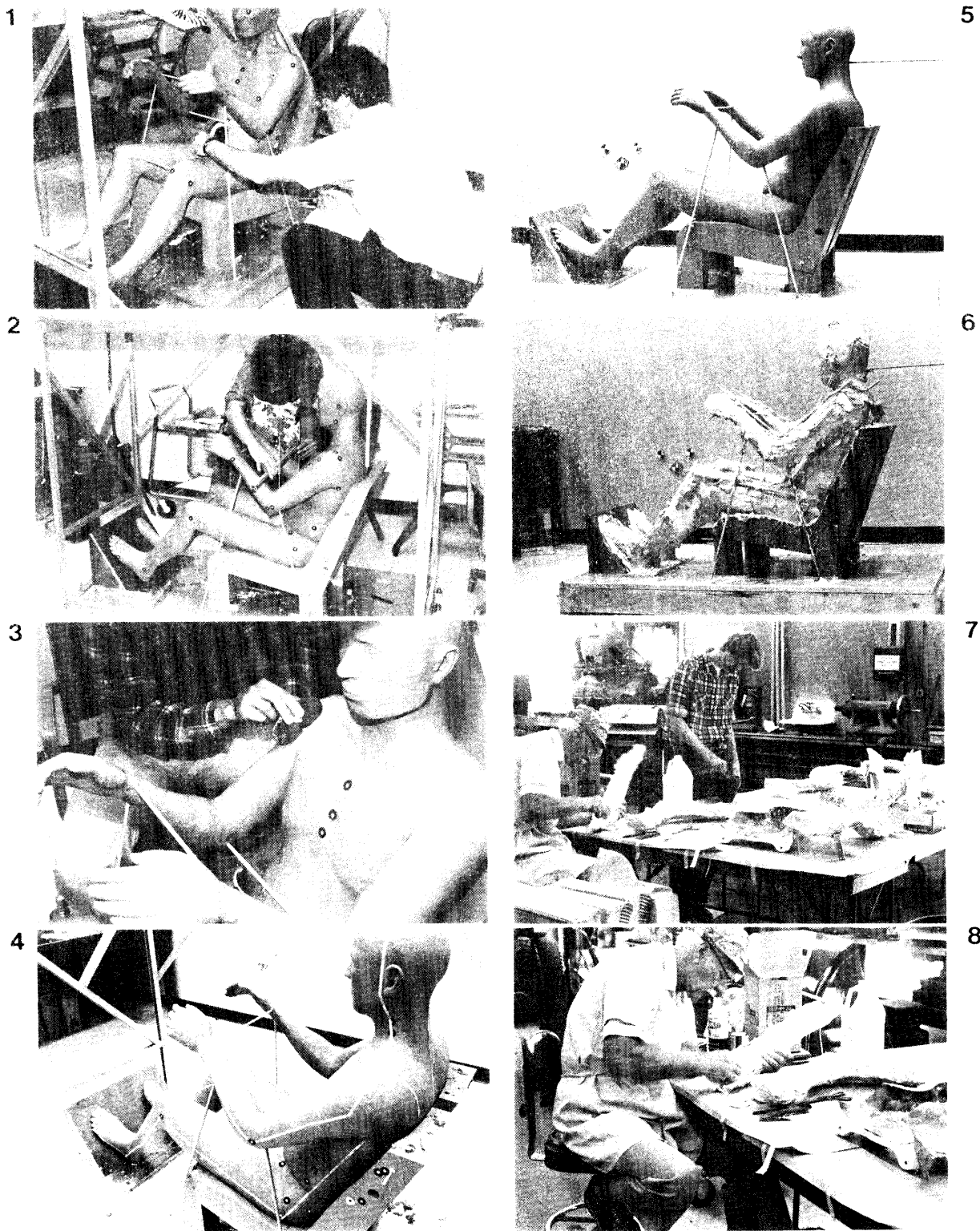


FIGURE J-2. Completing and validating the mid-sized male clay model and fabricating the multipiece plaster mold.

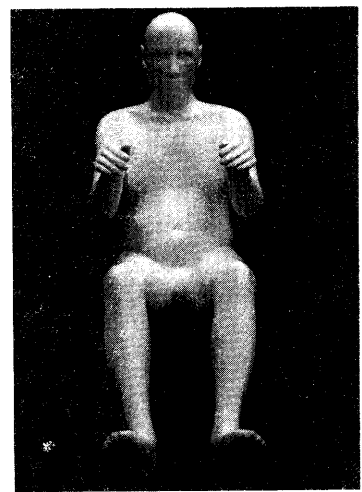
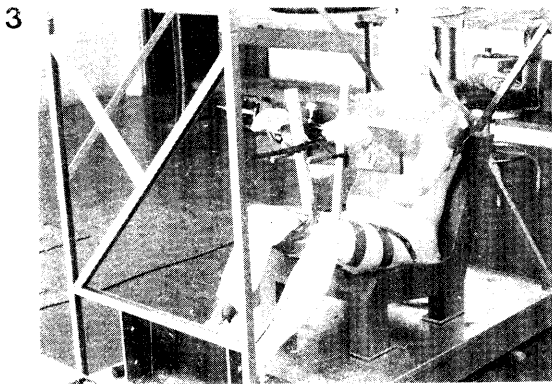
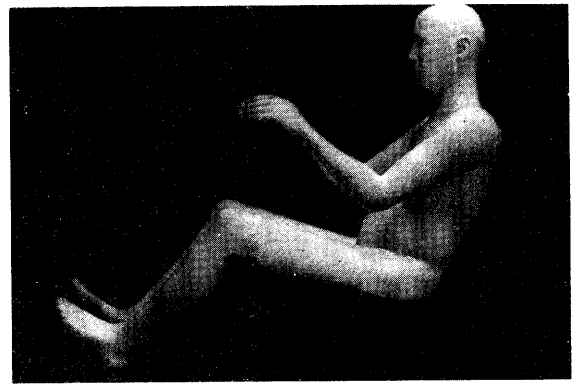
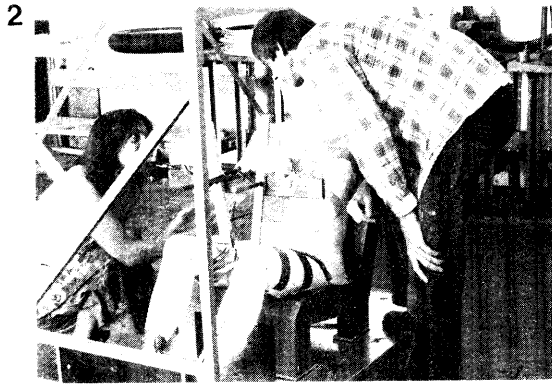
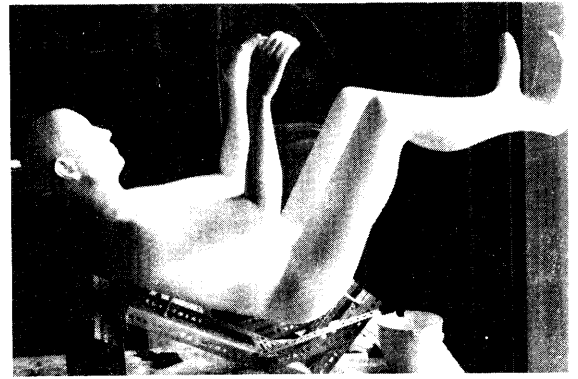


FIGURE J-3. Assembling and finishing the epoxy/fiberglass shell for the mid-sized male.

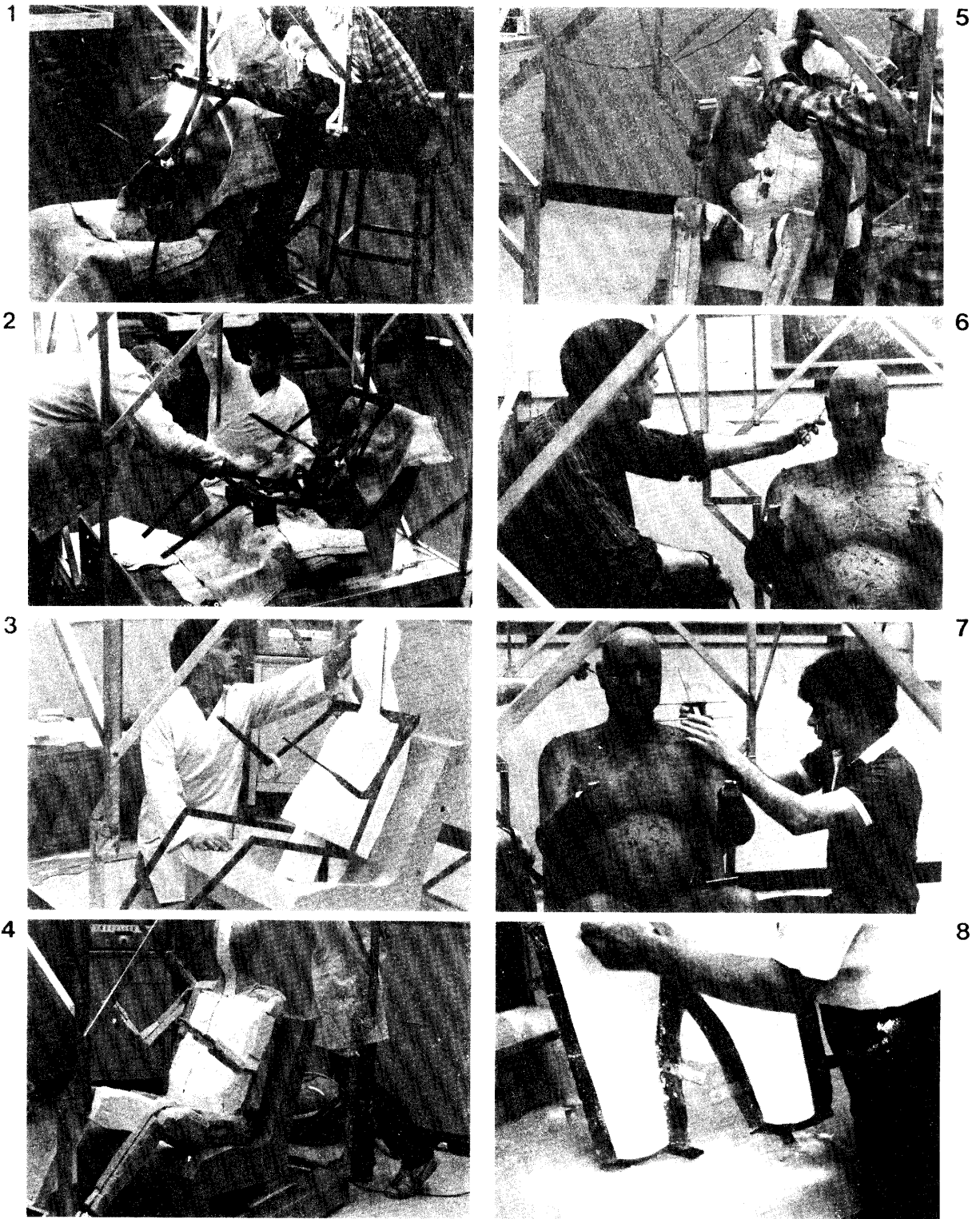


FIGURE J-4. Constructing and sculpting the large male clay model using a welded steel armature, styrofoam, and industrial styling clay.



FIGURE J-5. Completing the large male clay model and making the plaster/hemp mold.

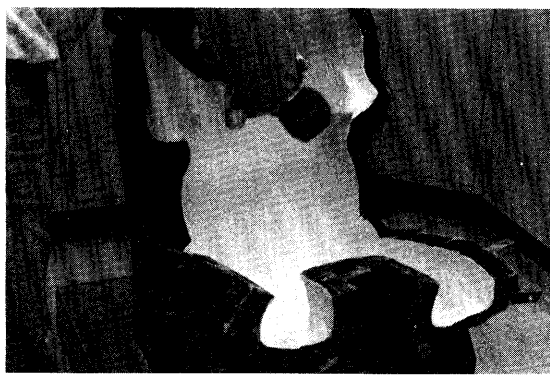
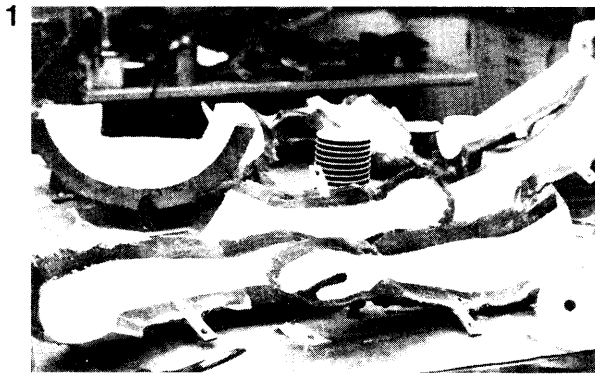


FIGURE J-6. Laying up epoxy/fiberglass in mold parts and assembling the large male shell.

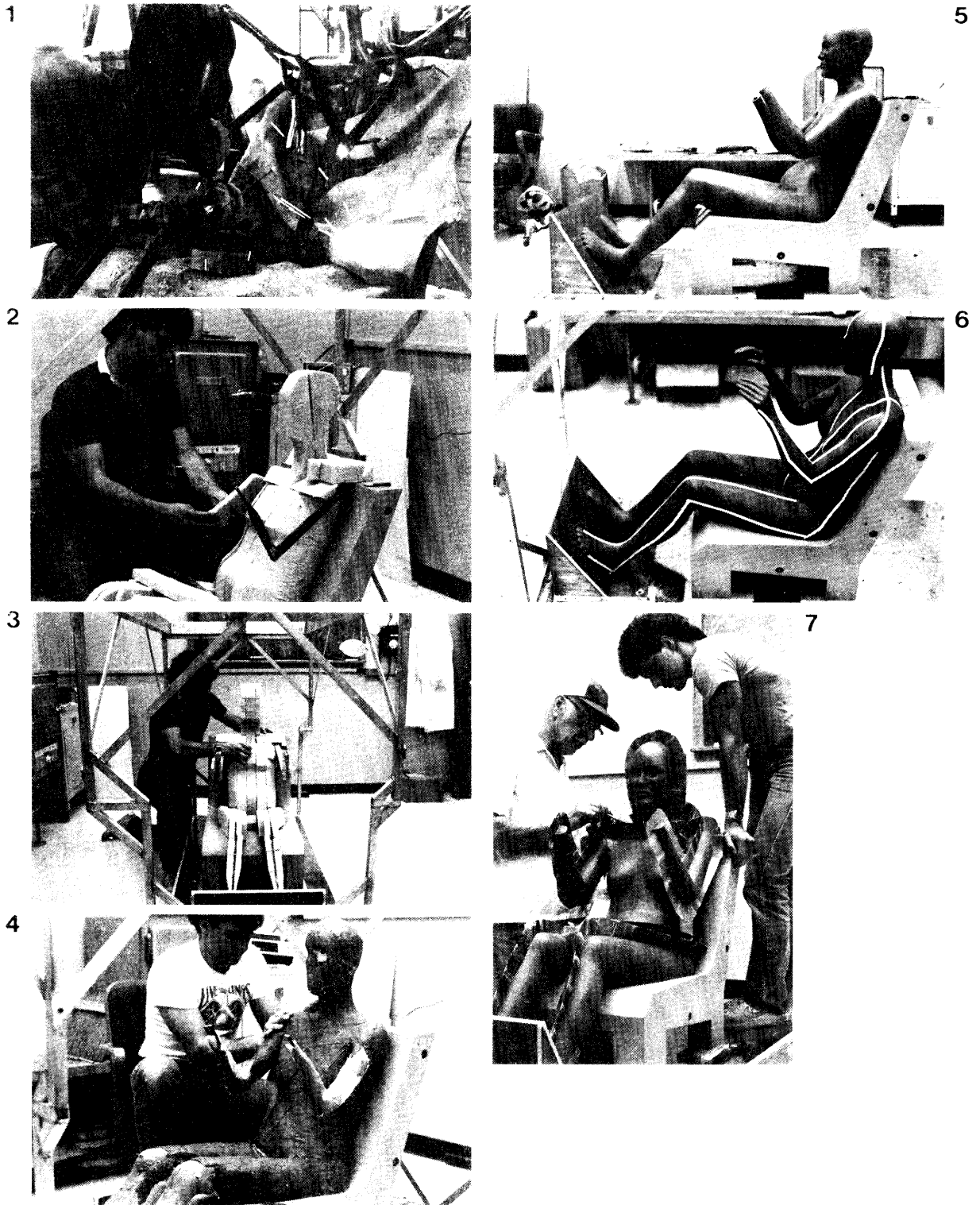


FIGURE J-7. Constructing and sculpting the small female clay model using a welded steel armature, styrofoam, and industrial styling clay.

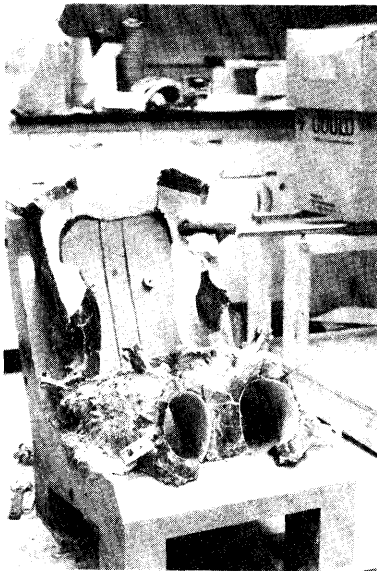
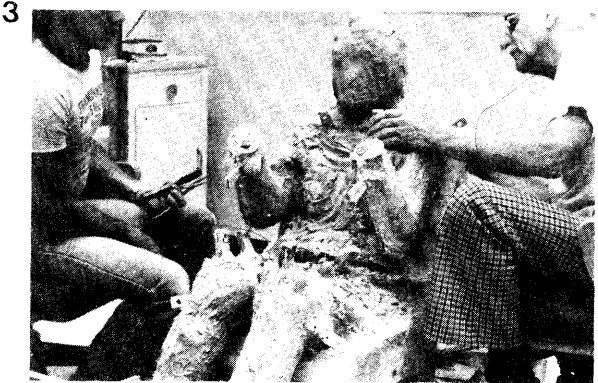
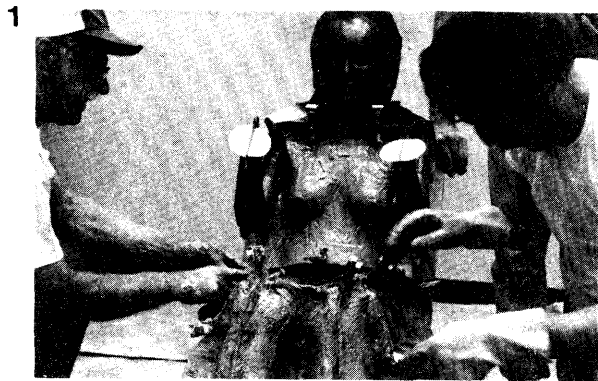


FIGURE J-8. Making the plaster/hemp mold and epoxy/fiberglass shell for the small female.

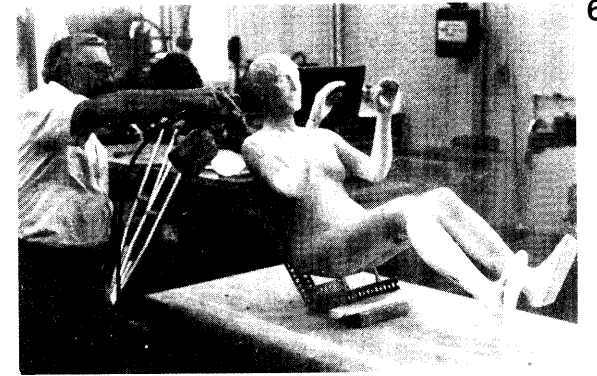
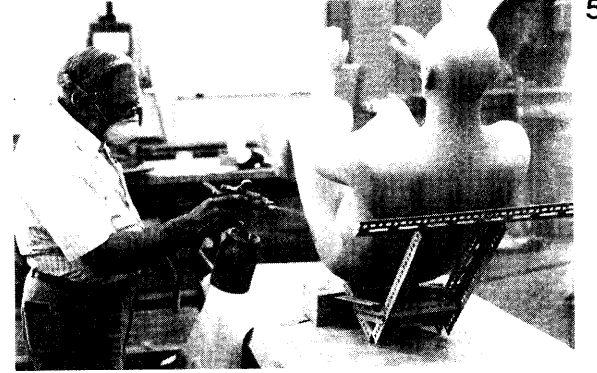
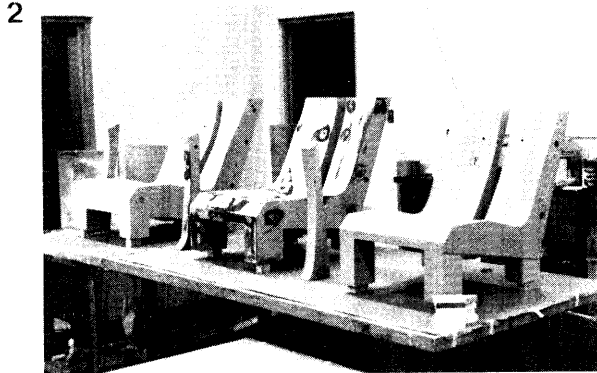
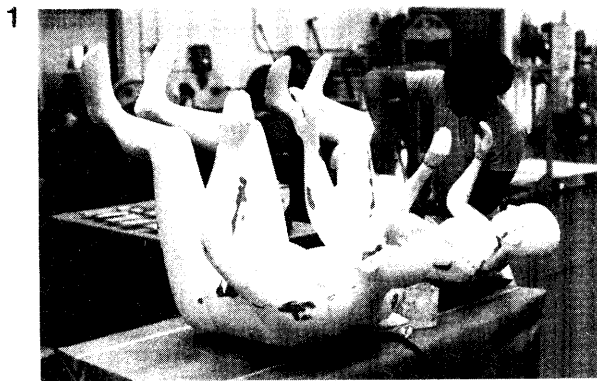


FIGURE J-9. Finishing, priming, and painting the assembled large male and small female epoxy/fiberglass shells.

APPENDIX K

PHOTOGRAPHS OF SURFACE SHELLS WITH SURFACE LANDMARK IDENTIFICATION NUMBERS

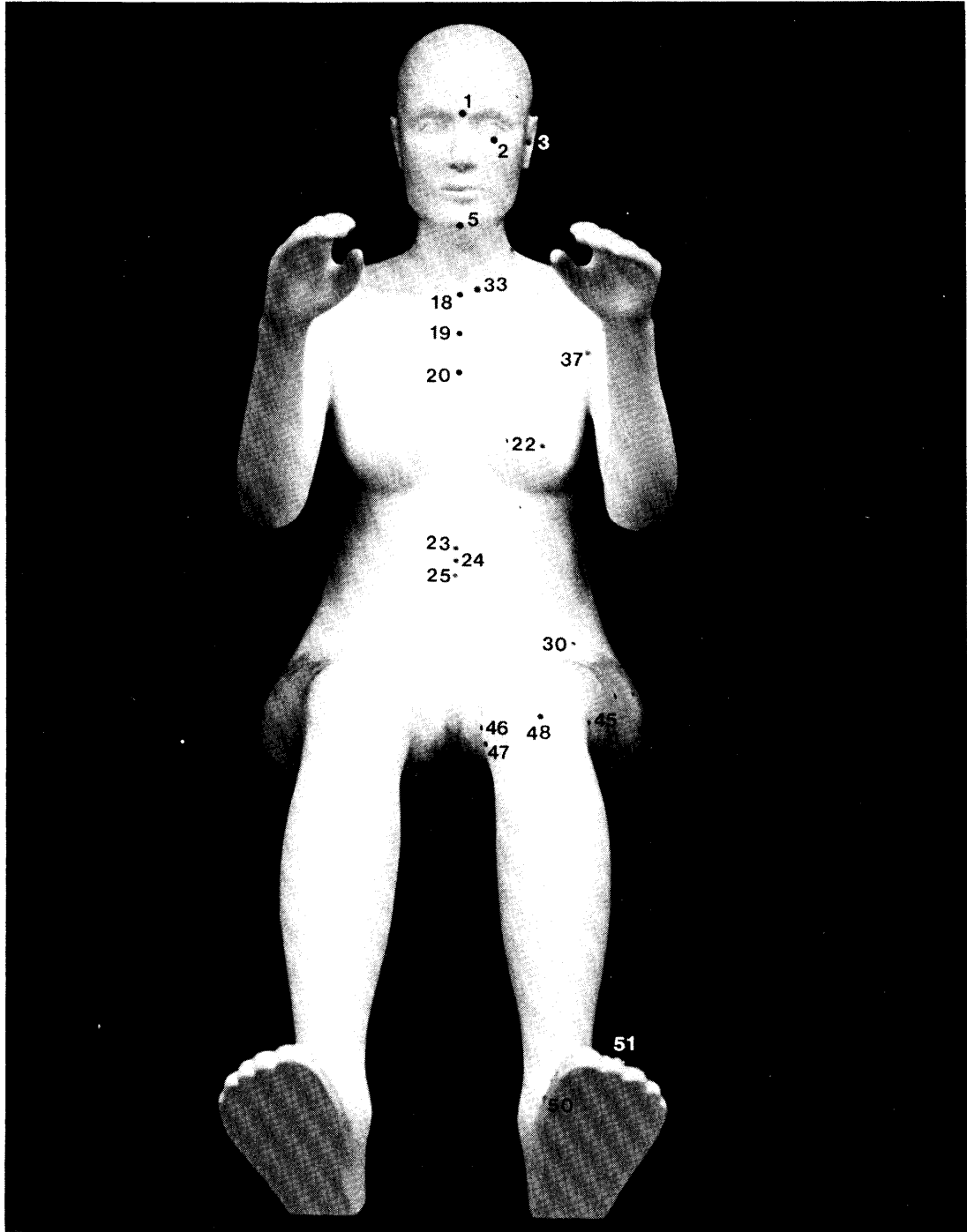
Table K.1 provides a listing of the surface shell landmarks by body region along with the reference number used to denote these landmarks on the full-size engineering drawings that supplement this report and the anthropometric specification packages contained in separate Volumes 1 and 2 of this report. Black rivets, denoting skeletal palpations, and gold rivets, denoting other surface landmarks, have been placed in the completed surface shells to mark these surface landmarks on the forms. In the photographs which follow Table K.1, the reference numbers of each landmark are provided next to the rivet to identify the landmark on the form.

TABLE K.1
LIST OF SURFACE LANDMARKS

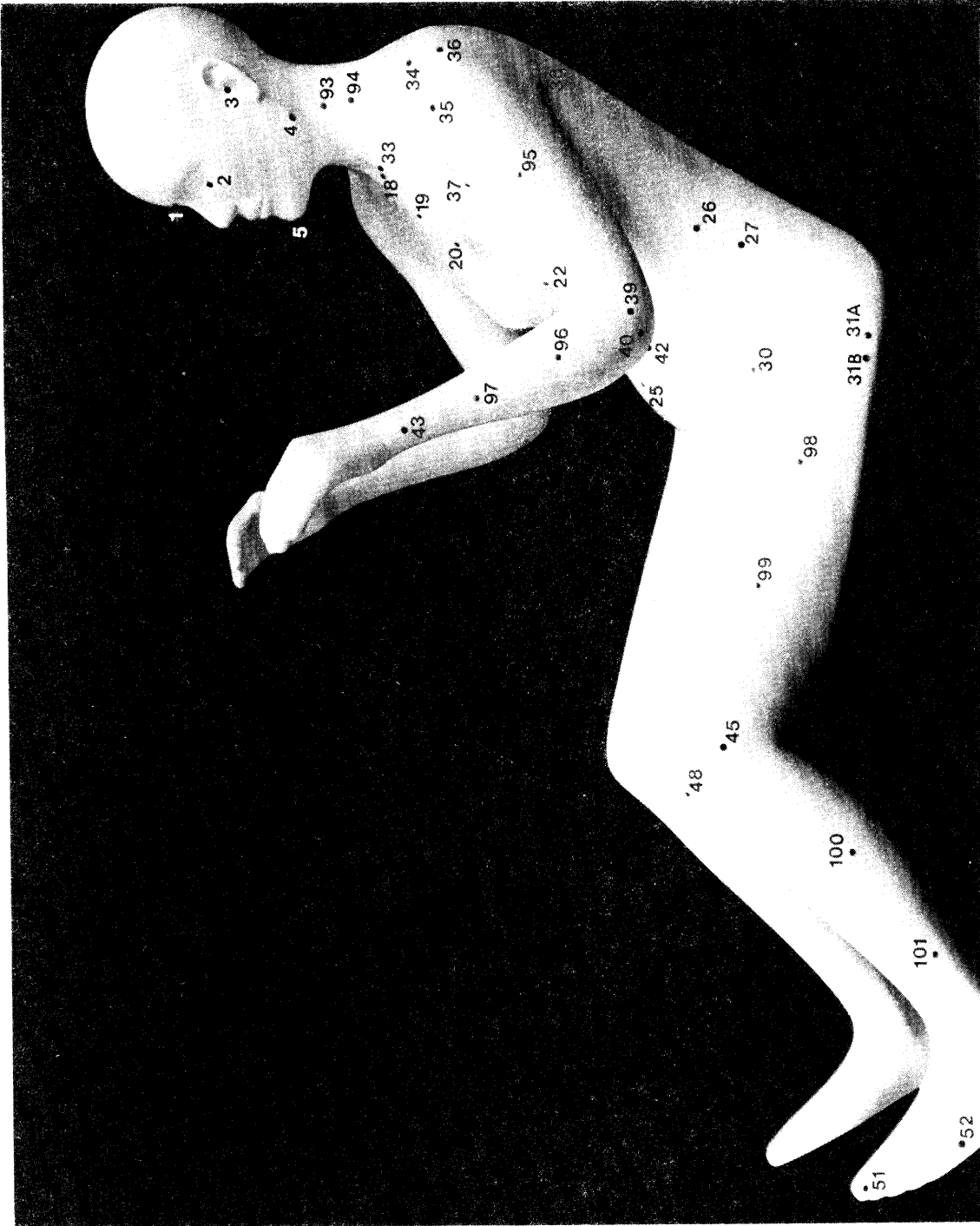
Body Region	Ref. No.	Landmark Name
Head and Neck	1	Glabella
	2	Infraorbitale
	3	Tragion
	4	Gonion
	5	Gnathion
Spine and Scapula	7	Cervicale (C7)
	8	T4
	9	T8
	10	T12
	11	L2
	12	L5
	13	10th Rib, Mid-Spine
	14	Scapula, Superior Margin
	15	Scapula, Inferior Margin
Chest and Torso	18	Suprasternale
	19	Mesosternale
	20	Substernale
	21	Bimammary Midline
	22	Nipple
	23	10th Rib, Anterior Midline
	24	Umbilicus
	25	Maximum Abdominal Protrusion
	26	10th Rib
Pelvis and Hip	27	Iliocristale
	28	Anterior-Superior Iliac Spine (ASIS)
	29	Symphysion (Pubic Symphysis)
	30	Thigh-Abdominal Junction
	31a	Trochanterion (palpated)
	31b	Trochanterion (skeletal reconstruction)
Shoulder	33	Clavicale
	34	Acromio-Clavicular Articulation
	35	Greater Tubercle Humerus
	36	Acromion
	37	Scye, Anterior
	38	Scye, Posterior
Arm and Hand	39	Lateral Humeral Epicondyle
	40	Radiale
	41	Medial Humeral Epicondyle
	42	Olecranon
	43	Ulnar Styloid
	44	Styliion

TABLE K.1
LIST OF SURFACE LANDMARKS (Continued)

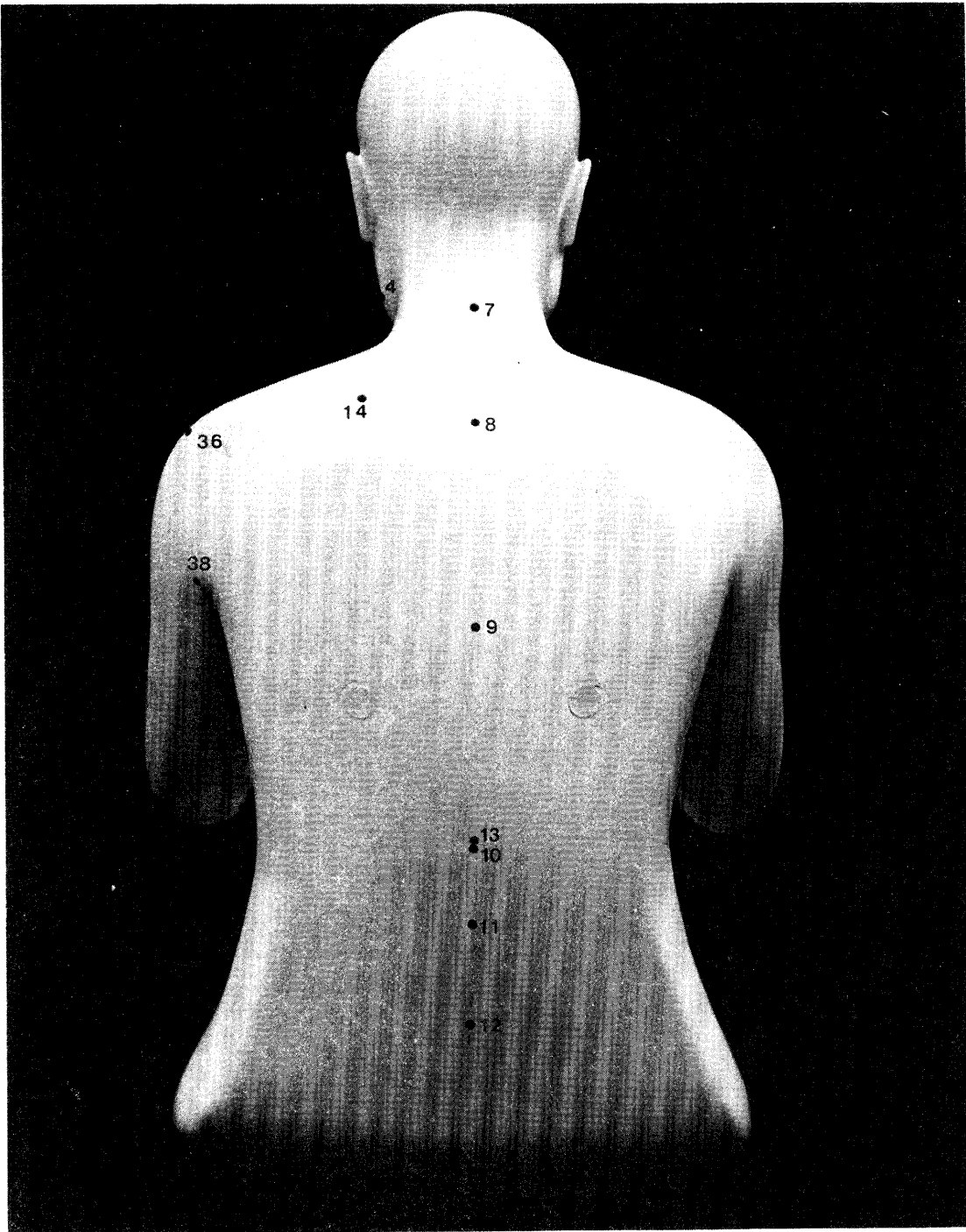
Body Region	Ref. No.	Landmark Name
Leg and Foot	45	Lateral Femoral Condyle
	46	Medial Femoral Epicondyle
	47	Tibiale
	48	Patella
	49	Sphyrion
	50	Metatarsal/Phalangeal I
	51	Digit II
	52	Metatarsal/Phalangeal V
	53	Lateral Malleolus
Anthro. Measurement Pts.	93	Neck, Mid
	94	Neck, Lower
	95	Arm, Upper
	96	Forearm, Upper
	97	Forearm, Lower
	98	Thigh, Upper
	99	Thigh, Mid
	100	Calf
	101	Ankle



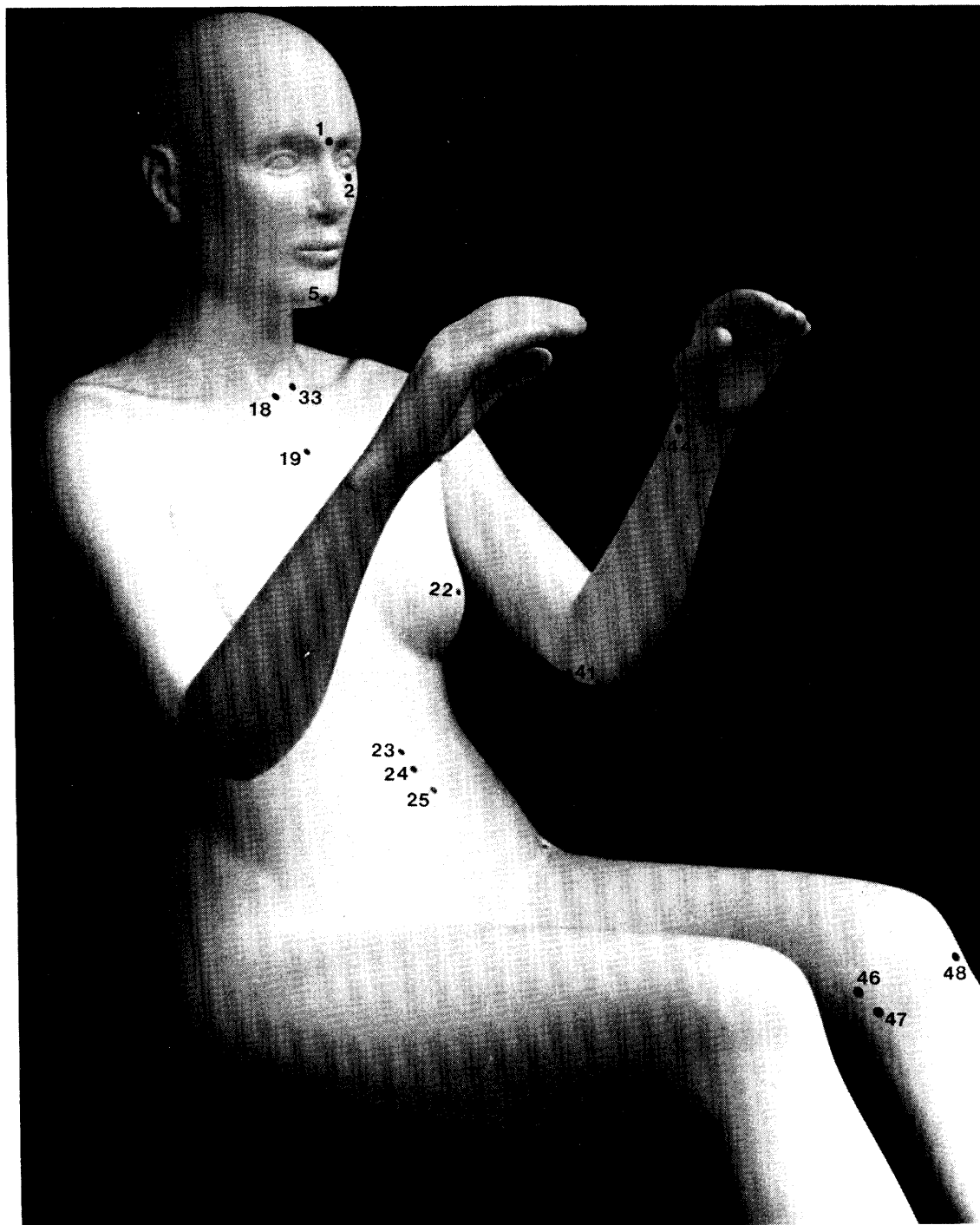
SMALL FEMALE - FRONT VIEW



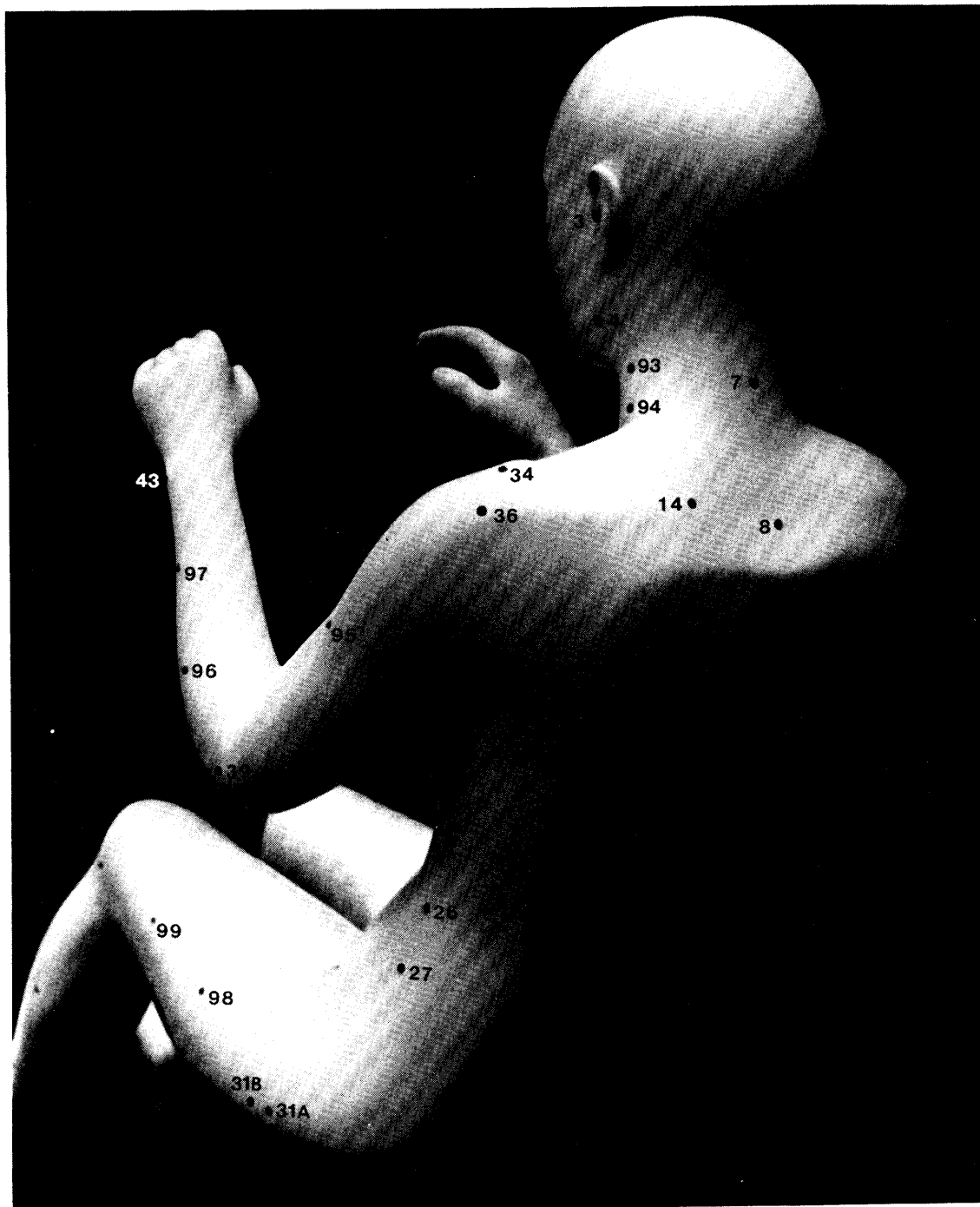
SMALL FEMALE - FULL LEFT SIDE VIEW



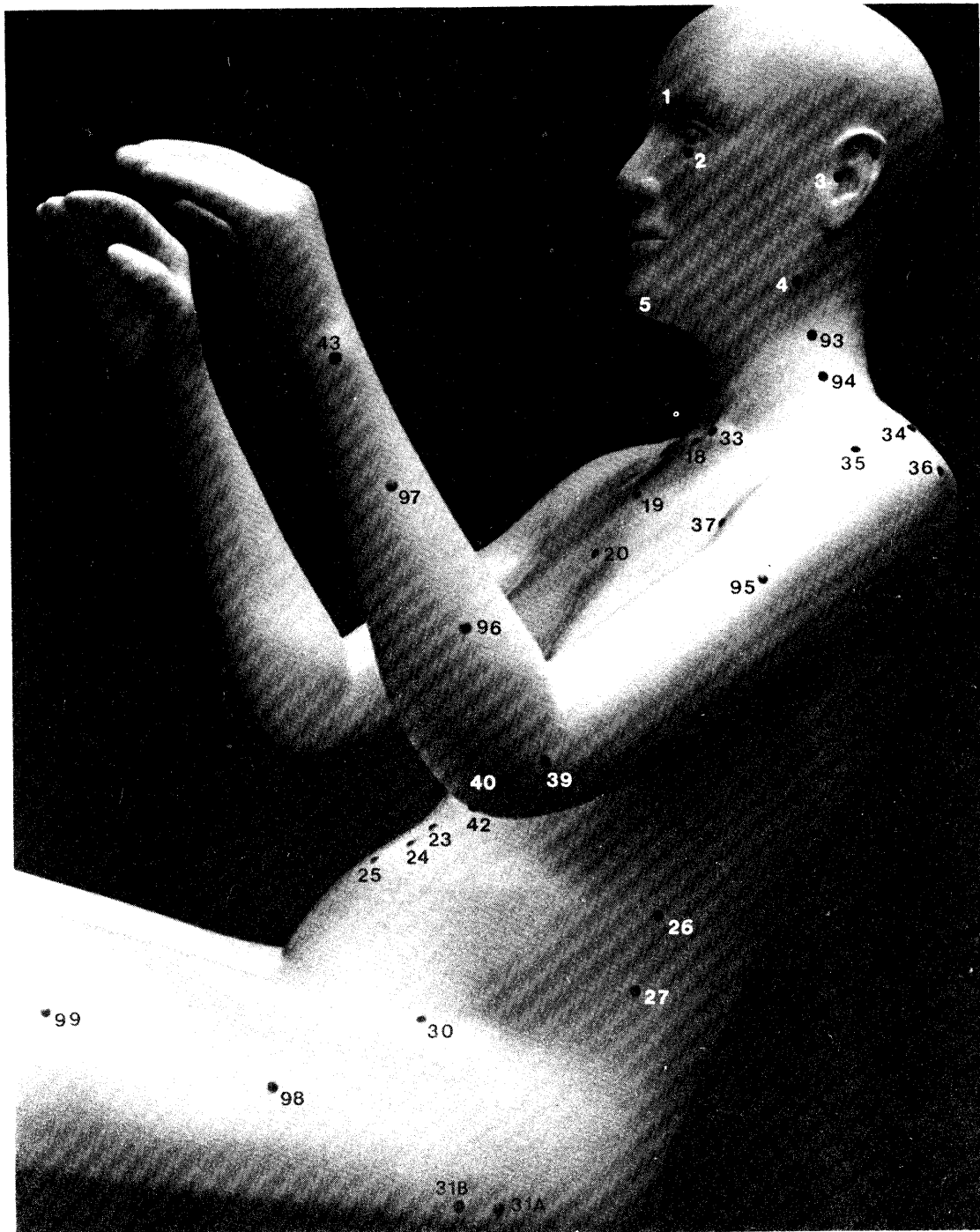
SMALL FEMALE - REAR VIEW



SMALL FEMALE – RIGHT FRONT OBLIQUE VIEW



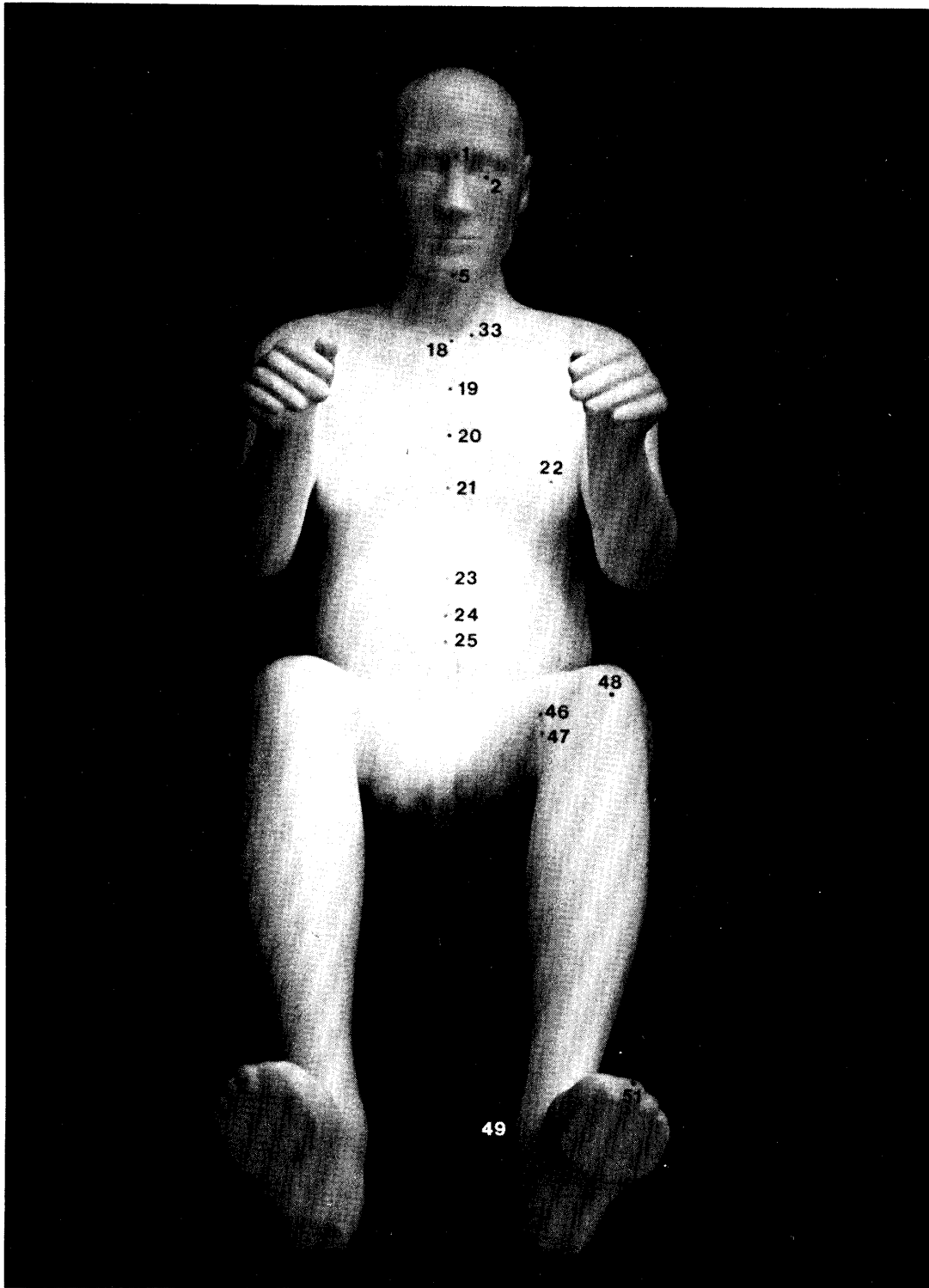
SMALL FEMALE - LEFT REAR OBLIQUE VIEW



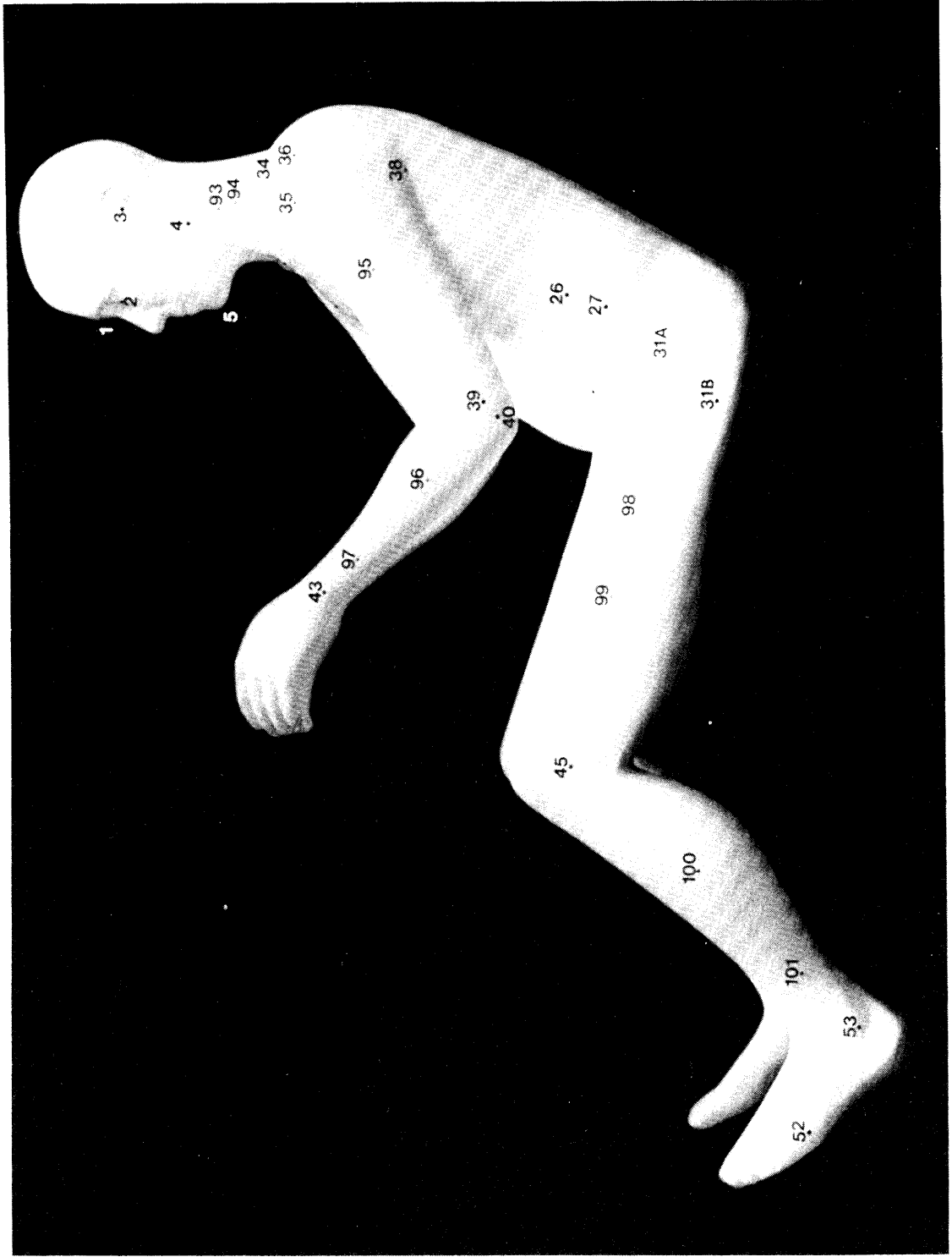
SMALL FEMALE - LEFT SIDE CLOSE-UP



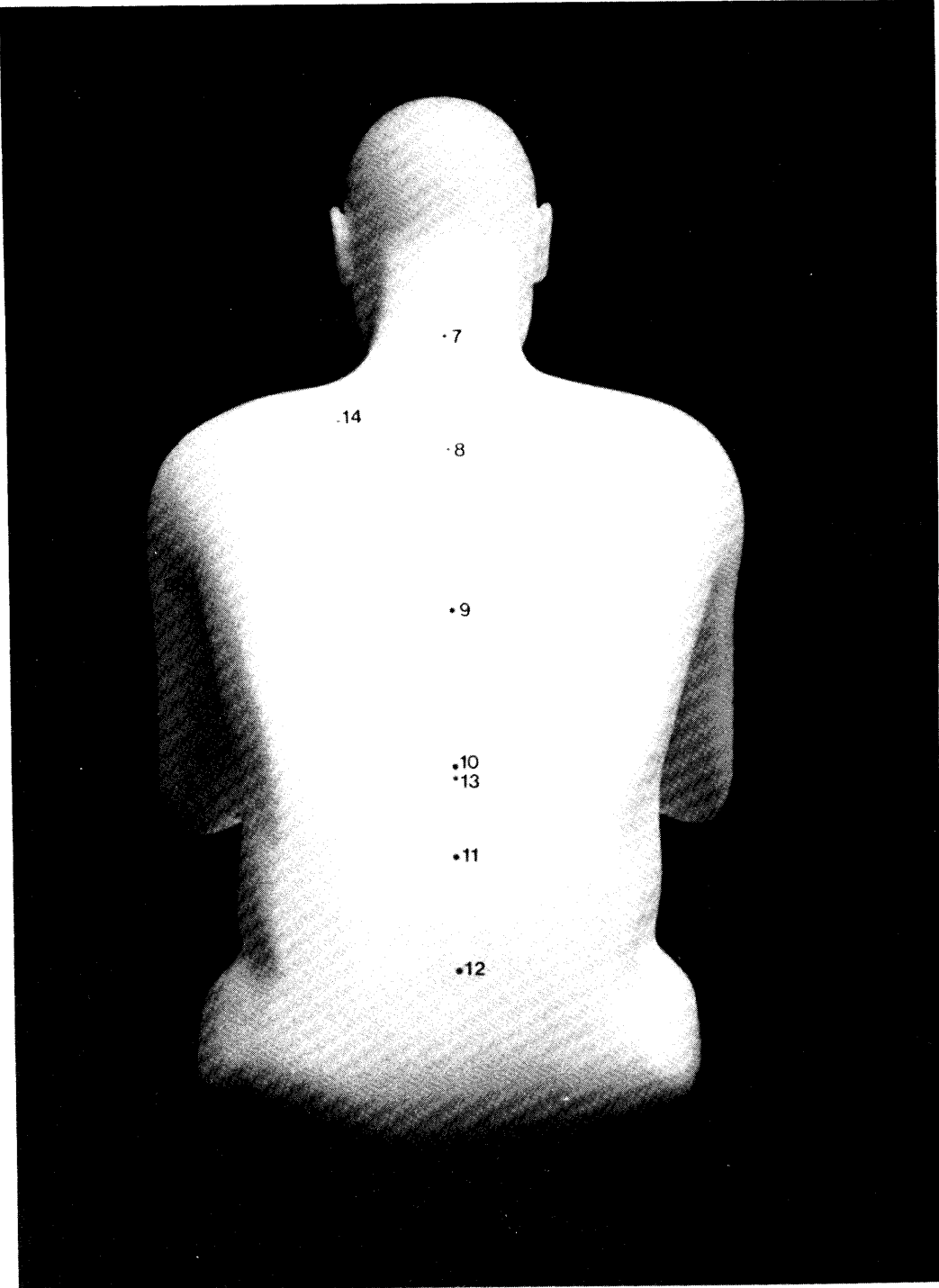
SMALL FEMALE - LEG AND FOOT VIEW



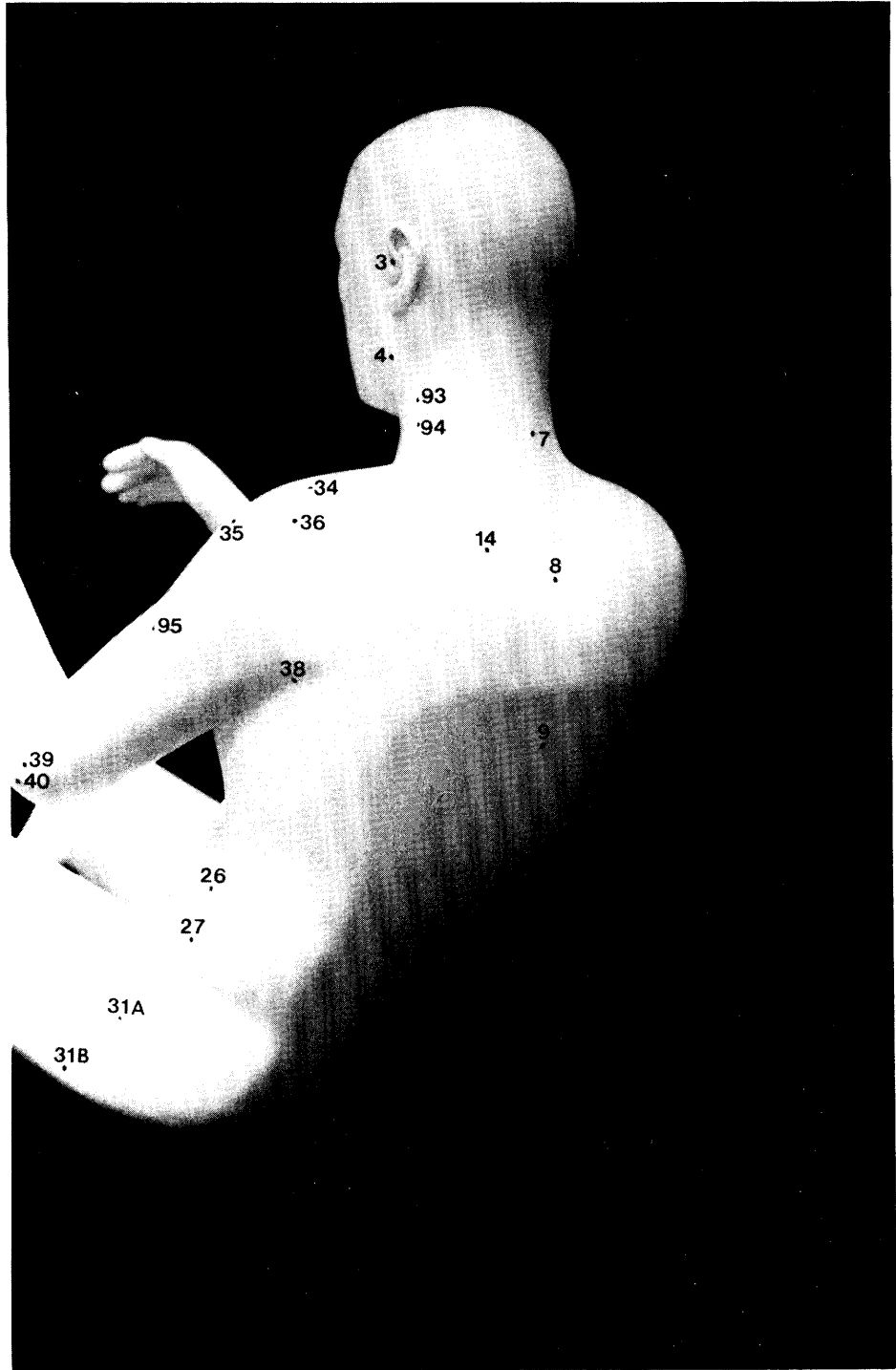
MID-SIZED MALE - FRONT VIEW



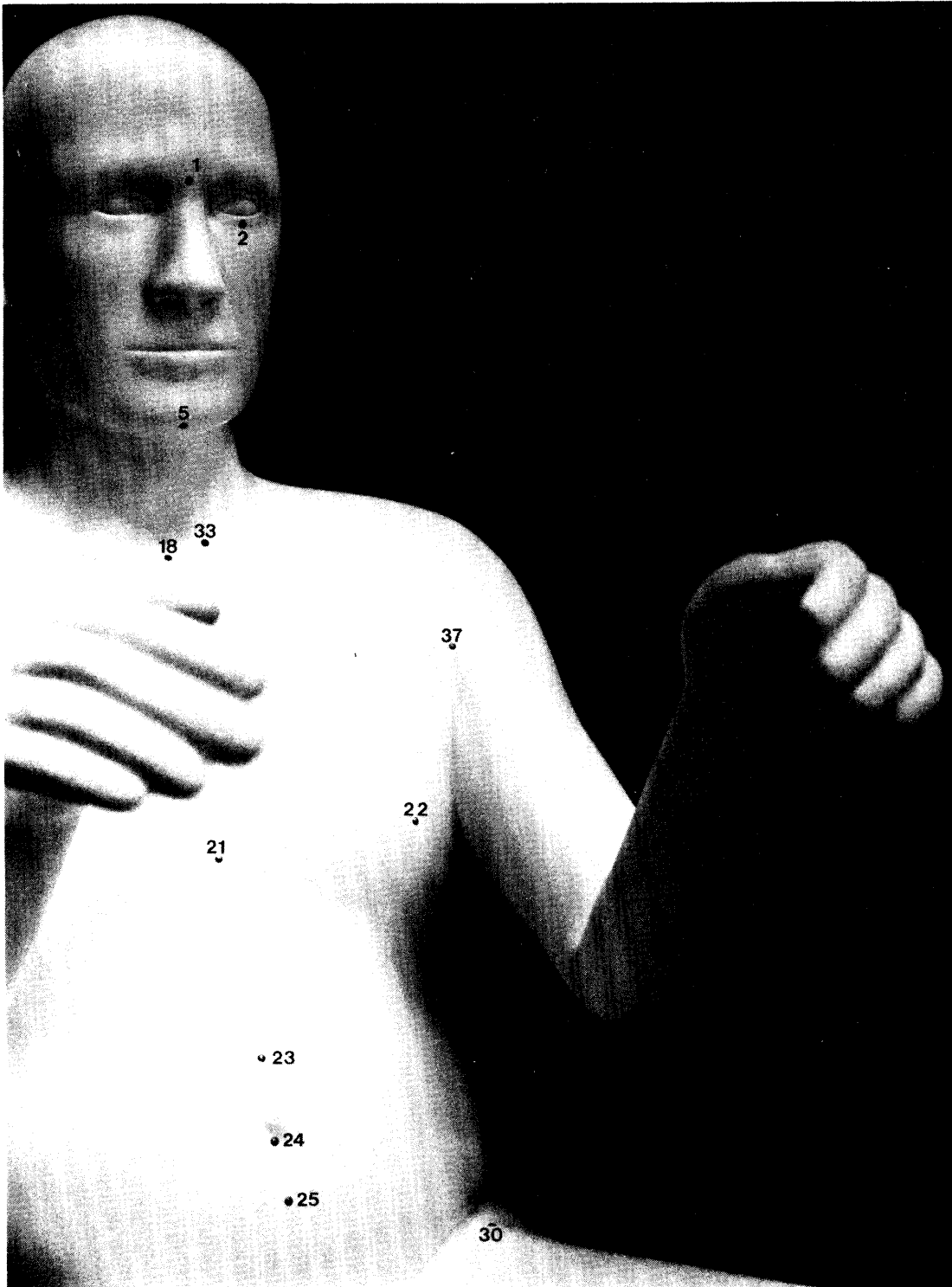
MID-SIZED MALE - FULL LEFT SIDE VIEW



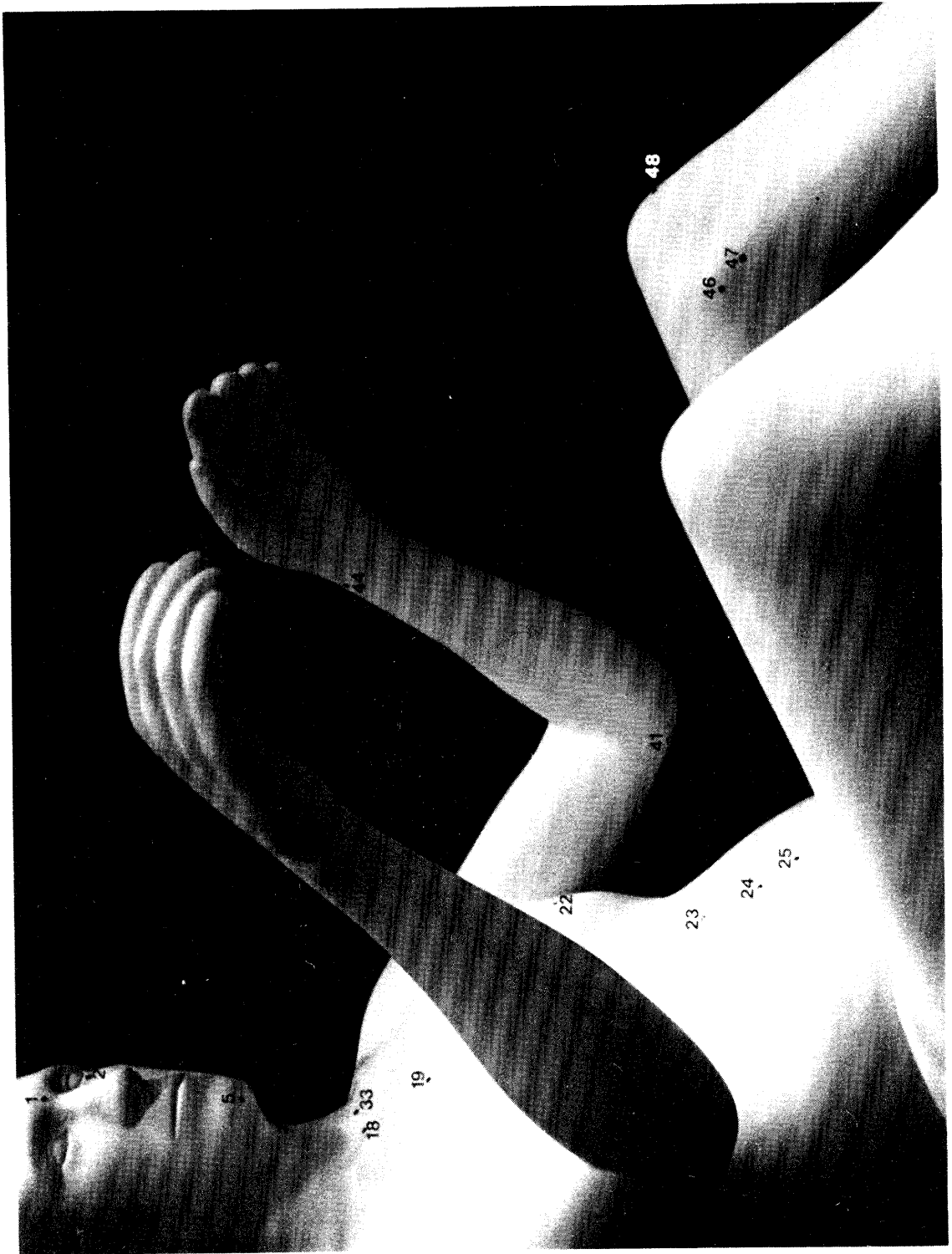
MID-SIZED MALE - REAR VIEW



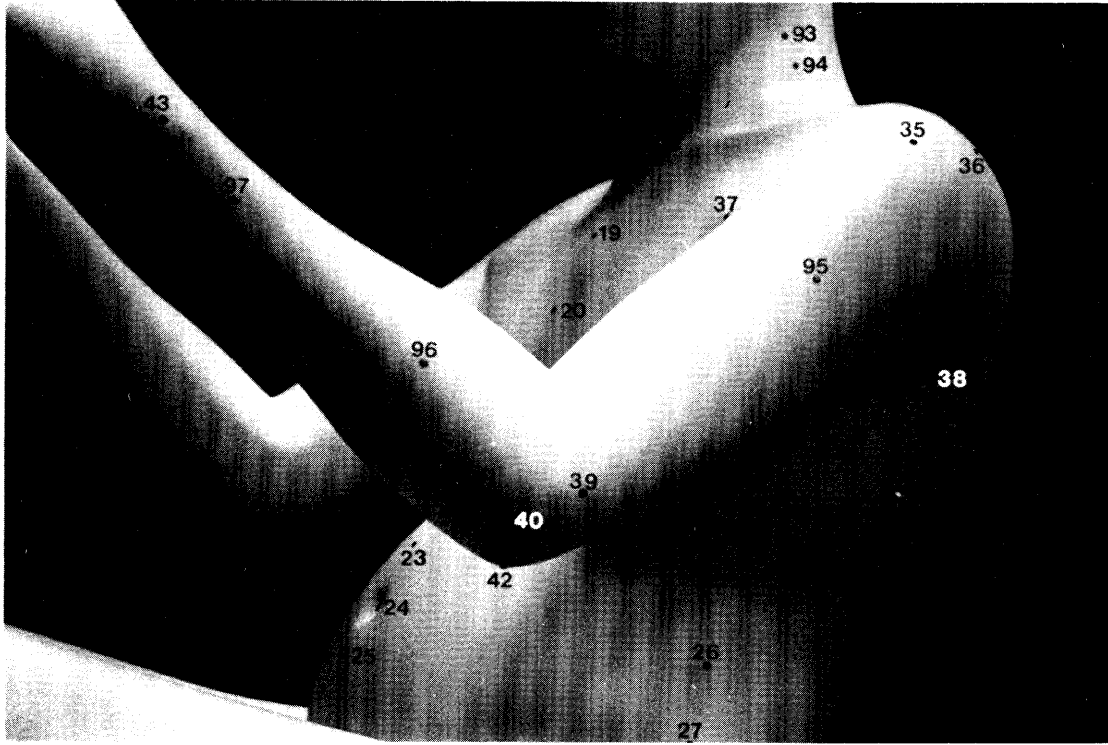
MID-SIZED MALE - LEFT REAR OBLIQUE VIEW



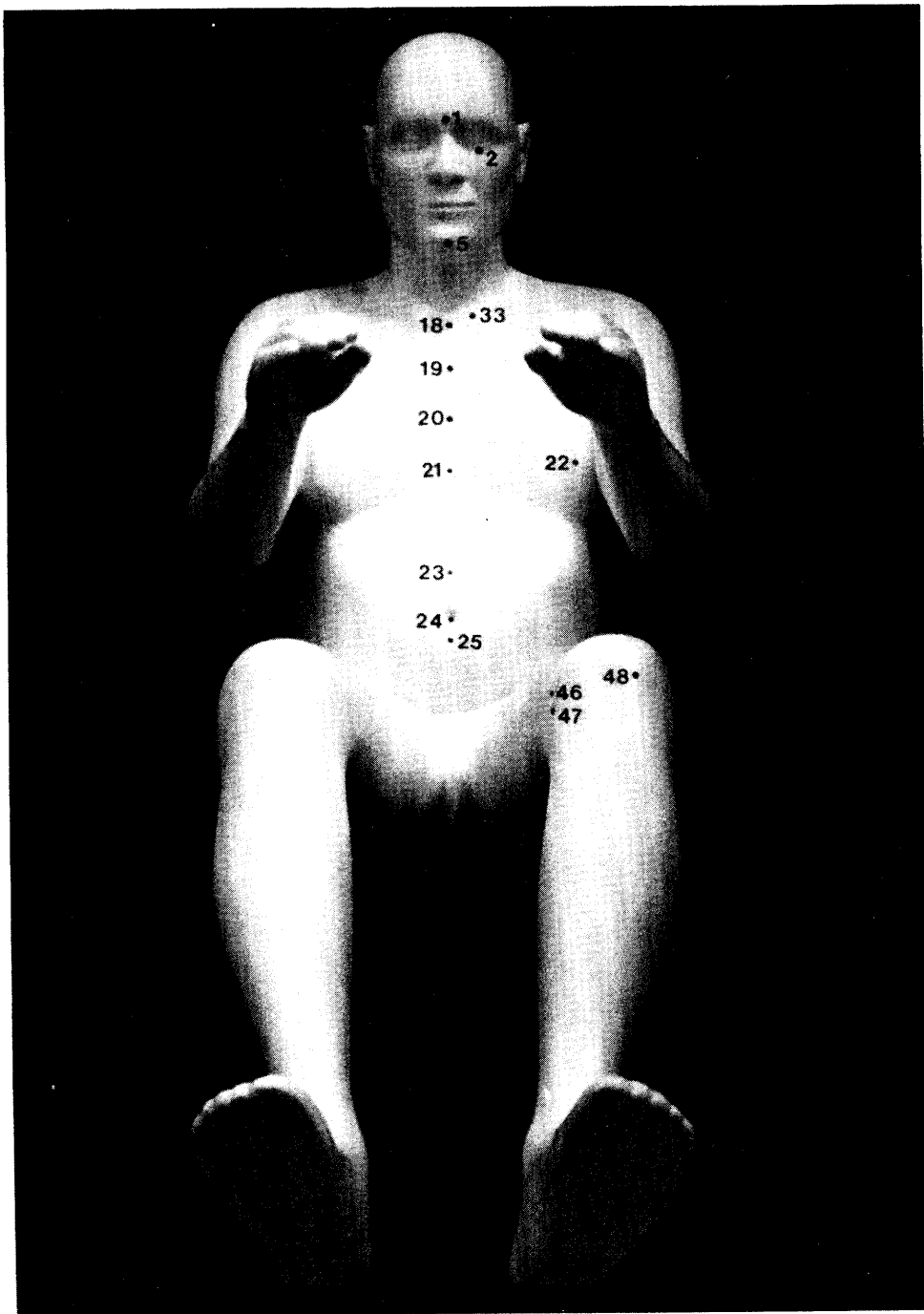
MID-SIZED MALE - RIGHT FRONT OBLIQUE CLOSE-UP



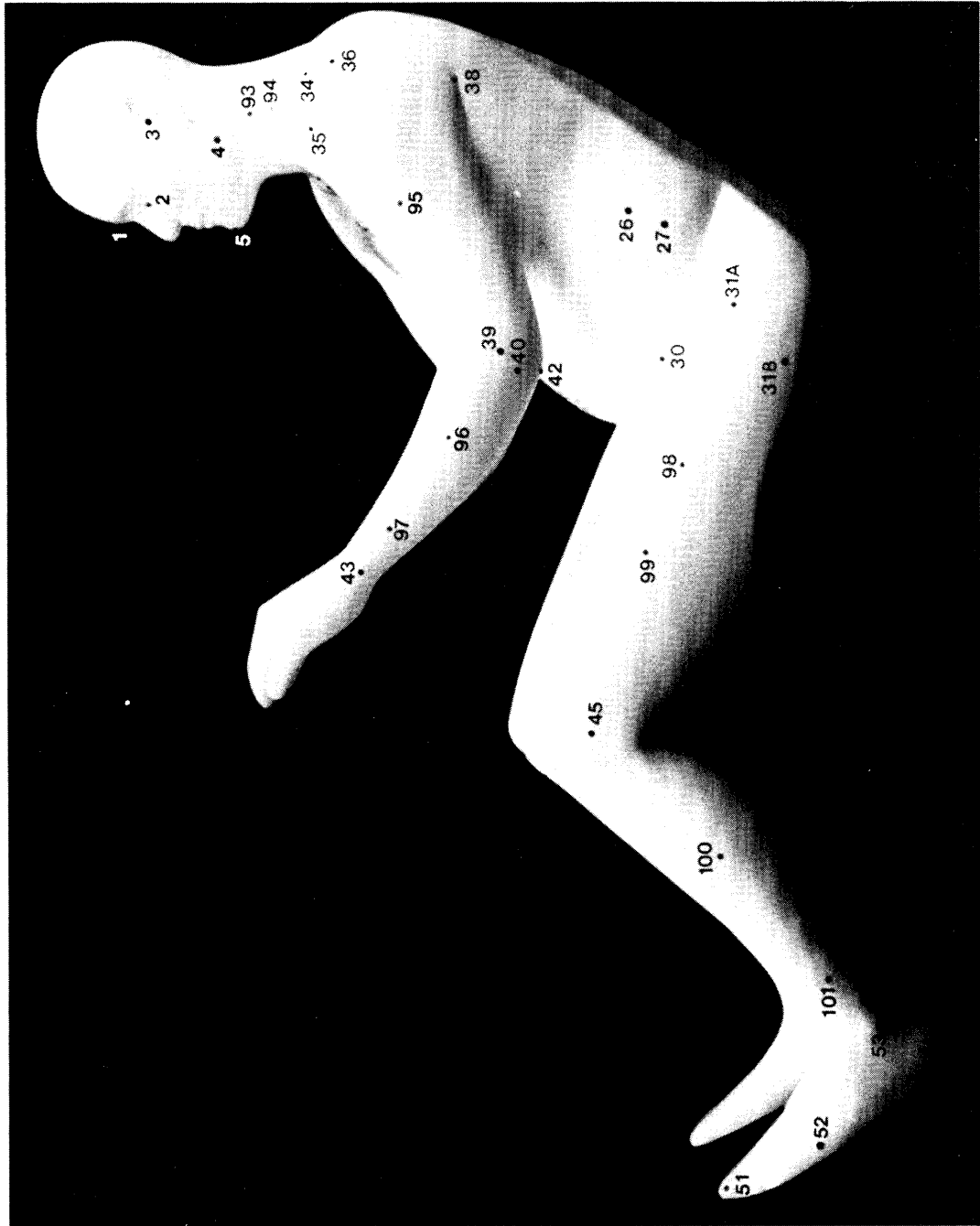
MID-SIZED MALE - RIGHT FRONT OBLIQUE VIEW



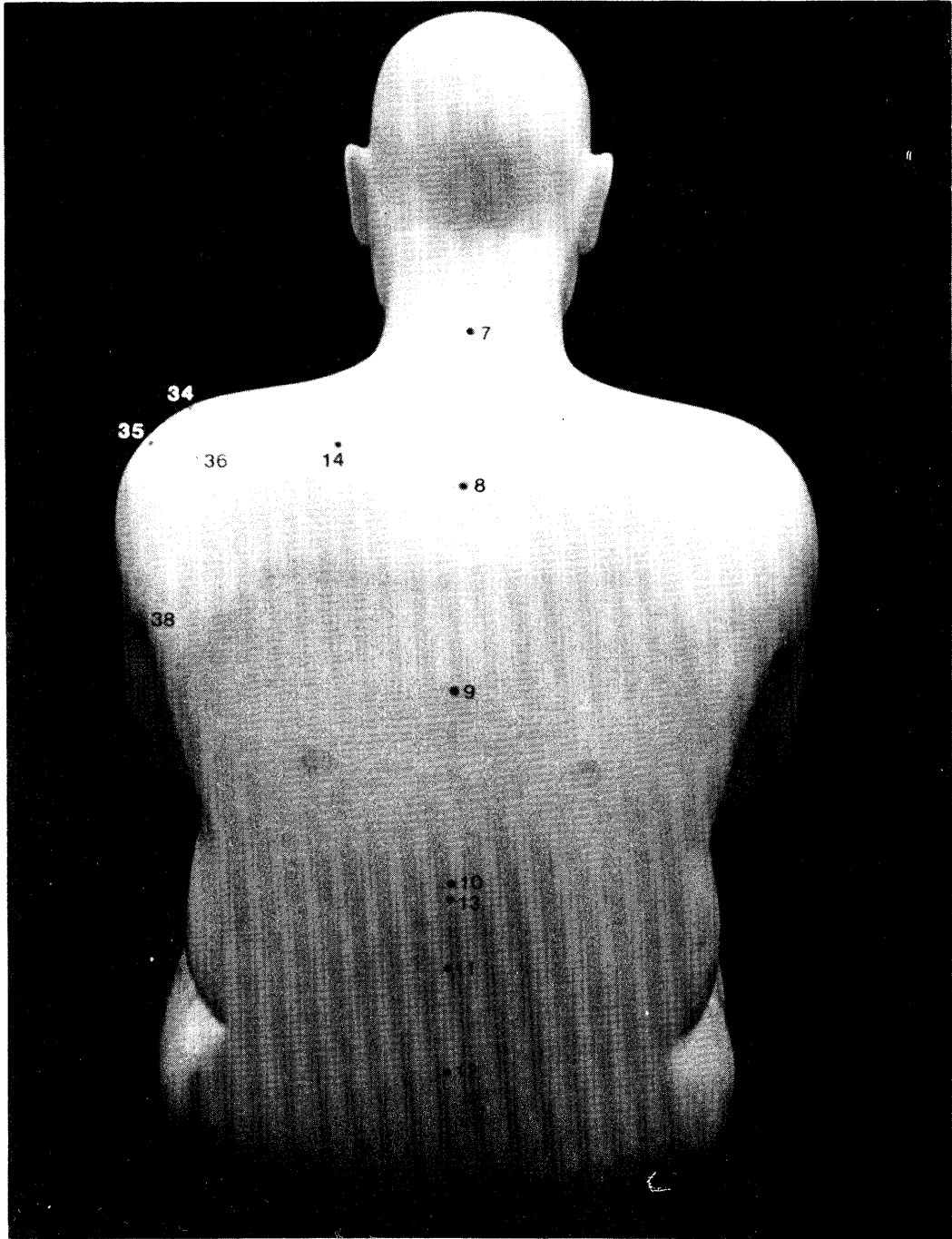
MID-SIZED MALE - LEFT SIDE CLOSE-UP



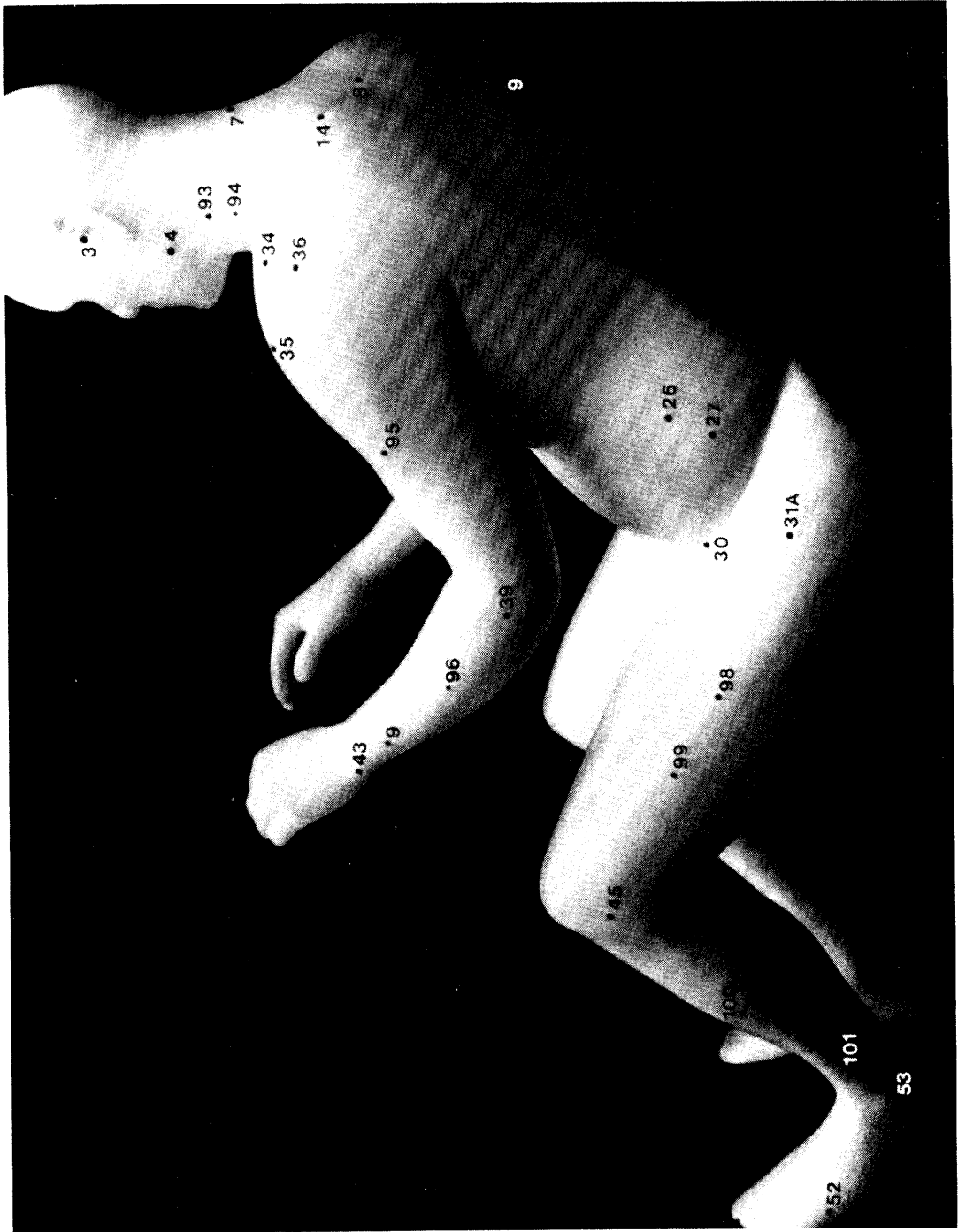
LARGE MALE - FRONT VIEW



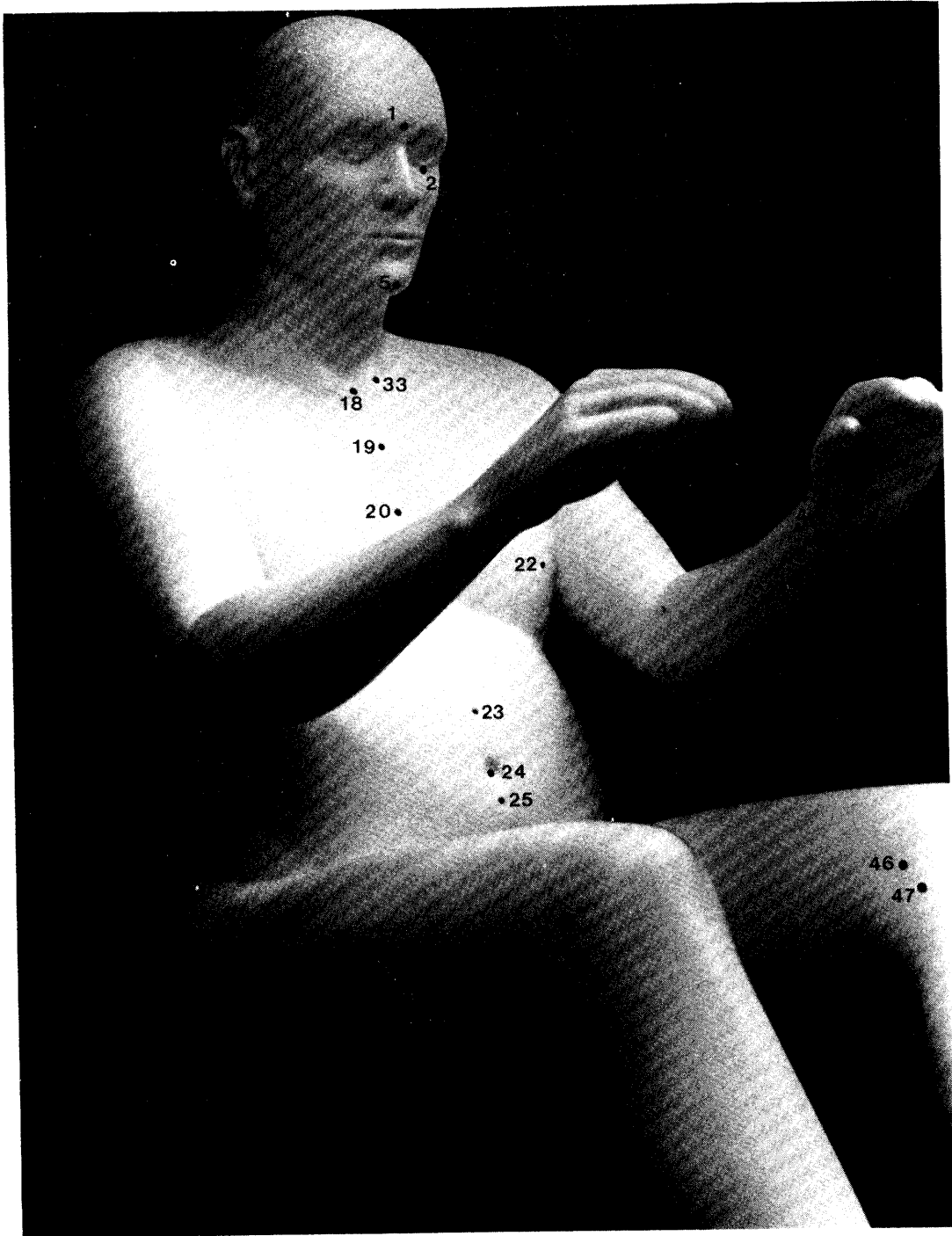
LARGE MALE - FULL LEFT SIDE VIEW



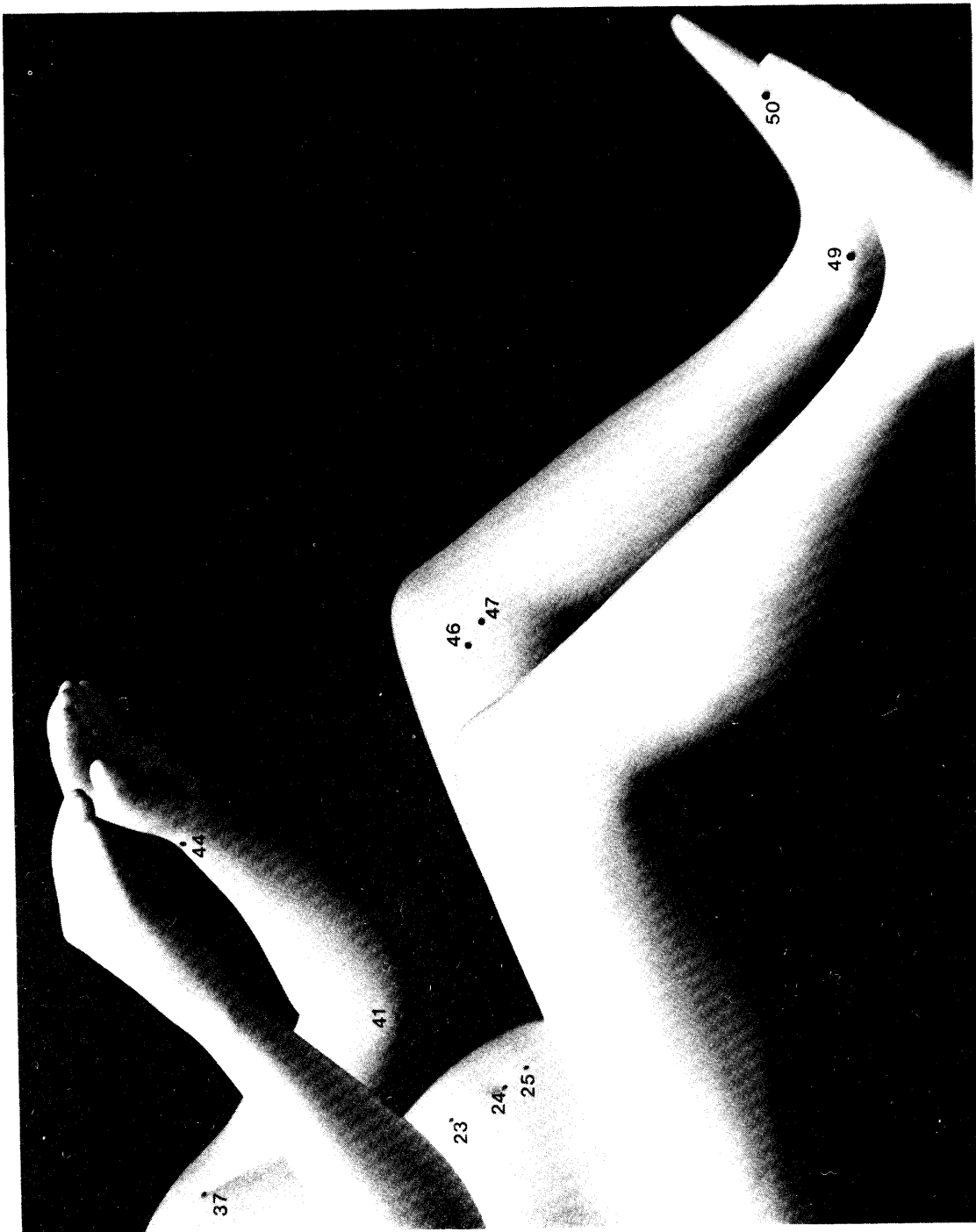
LARGE MALE - REAR VIEW



LARGE MALE - LEFT REAR OBLIQUE VIEW



LARGE MALE - RIGHT FRONT OBLIQUE VIEW



LARGE MALE - RIGHT SIDE LEG VIEW

APPENDIX L

COMPARISONS OF DESIRED AND ACTUAL VALUES FOR SEATED ANTHROPOMETRY AND SURFACE LANDMARK COORDINATES FOR THE SURFACE SHELLS

While considerable time, effort, and care went into sculpting the clay forms to the average Phase III measurement specifications and into the fabrication of the molds and epoxy shells, it was not possible to get all coordinates and measurements exactly to the desired values. Tables L.1 through L.6 compare the desired and actual values for the left sides of the three surface forms. Coordinate values given in these tables are in the laboratory system (X_L, Y_L, Z_L). Subscripts have been omitted in tables to condense the listings.

INDEX TO TABLES

Table No.	Title	Page No.
L.1	Small Female Anthropometry	L - 2
L.2	Small Female Landmark Laboratory Coordinates	L - 4
L.3	Mid-Sized Male Anthropometry	L - 9
L.4	Mid-Sized Male Landmark Laboratory Coordinates	L - 11
L.5	Large Male Anthropometry	L - 16
L.6	Large Male Landmark Laboratory Coordinates	L - 18

TABLE L.1

SMALL FEMALE SURFACE SHELL ANTHROPOMETRY
(Desired vs. Actual, cm or as noted)

Measurement Variable	Desired	Actual	Diff.
Sitting Height	93.3	93.3	0.0
Cervicale Height	71.2	71.2	0.0
Chin Height	73.2	73.2	0.0
Head Breadth	14.5	14.5	0.0
Head Height	20.0	20.2	+0.2
Head Length	18.3	18.3	0.0
Head Circumference	53.4	53.4	0.0
Neck Length (anterior)	8.1	*	*
Neck Breadth (mid)	9.1	9.2	+0.1
Neck Depth (mid)	9.0	9.2	+0.2
Neck Circumference (mid)	30.4	30.4	0.0
Neck Breadth (lower)	10.4	10.4	0.0
Neck Depth (lower)	9.3	9.4	+0.1
Neck Circumference (lower)	32.2	32.2	0.0
Shoulder Height (mid)	68.2	68.2	0.0
Acromion Height	64.3	64.3	0.0
Clav.-to-Acr. Clavic. Artic	15.5	15.9	+0.4
Shoulder Breadth	38.0	38.3	+0.3
Shoulder Circumference	95.3	95.5	+0.2
Biacromial Breadth	34.2	34.2	0.0
Torso Depth (upper)	9.0	9.0	0.0
Shoulder Depth (scye)	10.5	10.5	0.0
Axillary Depth	9.8	*	*
Arm Angle (upper)	43.0°	43.0°	0.0°
Arm Angle (lower)	50.0°	53.0°	+3.0°
Right-Left Med. Hum. Epicondyle	30.0	30.0	0.0
Right-Left Stylion	27.2	27.2	0.0
Arm Circumference (scye)	36.9	*	*
Arm Breadth (upper)	6.7	7.0	+0.3
Arm Depth (upper)	8.9	8.9	0.0
Arm Circumference (upper)	25.3	25.2	-0.1
Arm Breadth (above elbow)	7.2	7.2	0.0
Arm Depth (above elbow)	7.4	7.4	0.0
Arm Circumference (above elbow)	24.0	23.9	-0.1
Olecranon Height	44.4	44.4	0.0
Elbow Breadth	6.4	6.5	+0.1
Elbow Depth	7.7	7.7	0.0
Elbow Circumference	23.3	23.6	+0.3
Forearm Breadth (upper)	6.2	6.3	+0.1
Forearm Depth (upper)	6.9	7.0	+0.1
Forearm Circumference (upper)	21.5	21.5	0.0
Forearm Circumference (lower)	15.8	15.7	-0.1
Wrist Breadth (condyles)	4.7	4.7	0.0

TABLE L.1
SMALL FEMALE SHELL ANTHROPOMETRY (Continued)

Measurement Variable	Desired	Actual	Diff.
Wrist Depth (condyles)	3.4	3.5	+0.1
Wrist Circumference (condyles)	14.2	14.0	-0.2
Chest Height (nipple)	51.7	52.0	+0.3
Chest Height (posterior scye) .	55.1	55.1	0.0
Chest Breadth (axilla)	26.0	26.0	0.0
Chest Circumference (axilla) .	82.4	*	*
Chest Breadth (nipple)	27.6	*	*
Chest Circumference (nipple) .	83.3	82.8	-0.5
Chest Circumference (10th rib)	68.9	*	*
Waist Breadth (umbilicus) . . .	24.7	25.7	+1.0
Waist Depth (umbilicus)	18.8	21.4	+2.6
Waist Circumference (umbilicus)	70.8	73.0	+2.2
Abdominal Breadth (max.)	27.9	27.9	0.0
Abdominal Depth (max.)	21.0	22.7	+1.7
Abdominal Circumference (max.)	75.4	79.3	+3.9
Iliocristale Height	35.3	35.4	+0.1
Thigh-Abdom. Junct. Height . .	32.7	32.7	0.0
Ant.-Sup. Iliac Spine Height .	34.2	*	*
Trochanterion Height	24.8	24.9	+0.1
Hip Breadth (max.)	35.6	37.7	+2.1
Bitrochanter Breadth	36.9	*	*
Leg Angle (upper)	9.0°	11.0°	+2.0°
Leg Angle (lower)	53.0°	52.0°	-1.0°
Right-Left Med. Fem. Epicondyle	6.4	6.4	0.0
Right-Left Sphyrion	11.3	11.2	-0.1
Troc.to-Lat. Fem. Condyle . . .	38.1	38.1	0.0
Thigh Breadth (upper)	17.6	17.6	0.0
Thigh Circumference (upper) . .	50.1	50.1	0.0
Thigh Breadth (mid)	12.5	12.5	0.0
Thigh Circumference (mid) . . .	42.7	42.7	0.0
Knee Height	38.8	38.8	0.0
Knee Breadth	8.7	9.0	+0.3
Knee Depth (popliteal)	11.1	11.1	0.0
Knee Circumference	33.9	33.8	-0.1
Calf Breadth	9.4	9.5	+0.1
Calf Depth	9.6	9.8	+0.2
Calf Circumference	31.5	31.5	0.0
Ankle Breadth (min.)	6.0	6.1	+0.1
Ankle Depth (min.)	6.7	6.8	+0.1
Ankle Circumference (min.) . .	21.4	21.5	+0.1
Ankle Breadth (condyles)	6.3	6.6	+0.3
Ankle Depth (condyles)	8.1	8.1	0.0
Ankle Circumference (condyles)	22.0	22.2	+0.2

*Cannot measure on shell.

TABLE L.2

SMALL FEMALE SURFACE SHELL LANDMARK LABORATORY COORDINATES
(Desired vs. Actual, mm)

Reference No. and Landmark	Coord.	Desired	Actual	Diff.
HEAD AND NECK:				
1. Glabella	X	665	667	+2
	Y	619	619	0
	Z	1003	1003	0
2. Infraorbitale	X	652	652	0
	Y	651	650	-1
	Z	975	976	+1
3. Tragion	X	575	575	0
	Y	686	686	0
	Z	970	970	0
4. Gonion	X	588	588	0
	Y	674	674	0
	Z	909	909	0
5. Gnathion	X	664	664	0
	Y	619	619	0
	Z	890	890	0
SPINE AND SCAPULA:				
7. C7	X	517	516	-1
	Y	619	618	-1
	Z	870	870	0
8. T4	X	496	494	-2
	Y	619	618	-1
	Z	789	789	0
9. T8	X	508	506	-2
	Y	619	618	-1
	Z	667	667	0
10. T12	X	555	554	-1
	Y	619	620	+1
	Z	547	547	0
11. L2	X	575	575	0
	Y	619	619	0
	Z	504	504	0
12. L5	X	601	600	-1
	Y	619	620	+1
	Z	448	448	0

TABLE L.2
SMALL FEMALE SHELL LABORATORY COORDINATES (Continued)

Reference No. and Landmark	Coord.	Desired	Actual	Diff.
SPINE AND SCAPULA (Continued)				
13. 10th Rib, mid-spine . . .	X	554	554	0
	Y	619	620	+1
	Z	551	551	0
14. Scapula, Sup. Marg. . . .	X	493	494	+1
	Y	685	685	0
	Z	804	804	0
15. Scapula, Inf. Marg. . . .	X	505	*	*
	Y	728	*	*
	Z	717	*	*
CHEST AND TORSO:				
18. Suprasternale	X	611	612	+1
	Y	619	617	-2
	Z	816	815	-1
19. Mesosternale	X	645	645	0
	Y	619	617	-2
	Z	778	778	0
20. Substernale	X	666	667	+1
	Y	619	617	-2
	Z	741	741	0
21. Bimammary Midline	X	---	---	--
	Y	---	---	--
	Z	---	---	--
22. Nipple	X	716	716	0
	Y	704	703	-1
	Z	675	675	0
23. 10th Rib, Ant. Midline .	X	745	745	0
	Y	619	618	-1
	Z	575	575	0
24. Umbilicus	X	756	756	0
	Y	619	619	0
	Z	566	565	-1
25. Max. Abdom. Protrusion .	X	777	777	0
	Y	619	619	0
	Z	554	554	0
26. 10th Rib	X	659	659	0
	Y	748	748	0
	Z	550	550	0

TABLE L.2
SMALL FEMALE SHELL LABORATORY COORDINATES (Continued)

Reference No. and Landmark	Coord.	Desired	Actual	Diff.
PELVIS AND HIP:				
27. Iliocristale	X	672	672	0
	Y	757	758	+1
	Z	511	511	0
28. Ant. Sup. Iliac Spine . .	X	740	*	*
	Y	722	*	*
	Z	500	*	*
29. Pubic SymphYsis	X	799	*	*
	Y	619	*	*
	Z	457	*	*
30. Thigh-Abdom. Junction . .	X	777	777	0
	Y	736	736	0
	Z	485	484	-1
31a. Trochanterion (palpated)	X	752	752	0
	Y	806	809	+3
	Z	406	406	0
31b. Trochanterion (reconstr.)	X	---	773	--
	Y	---	809	--
	Z	---	407	--
SHOULDER:				
33. Clavicale	X	609	611	+2
	Y	636	635	-1
	Z	822	821	-1
34. Acromio-Clavicular Artic.	X	557	557	0
	Y	770	669	-1
	Z	823	825	+2
35. Gr. Tubercle Humerus . .	X	603	603	0
	Y	797	797	0
	Z	805	805	0
36. Acromion	X	549	549	0
	Y	790	791	+1
	Z	801	803	+2
37. Scye, anterior	X	649	650	+1
	Y	749	749	0
	Z	762	762	0
38. Scye, posterior	X	564	564	0
	Y	783	783	0
	Z	711	711	0

TABLE L.2
SMALL FEMALE SHELL LABORATORY COORDINATES (Continued)

Reference No. and Landmark	Coord.	Desired	Actual	Diff.
ARM AND HAND:				
39. Lat. Humeral Epicondyle .	X	767	767	0
	Y	830	830	0
	Z	631	631	0
40. Radiale	X	783	783	0
	Y	826	824	-2
	Z	618	618	0
41. Med. Humeral Epicondyle .	X	770	770	0
	Y	769	769	0
	Z	615	615	0
42. Olecranon	X	789	789	0
	Y	802	799	-3
	Z	602	603	+1
43. Ulnar Styloid	X	885	885	0
	Y	801	800	-1
	Z	808	808	0
44. Stylium	X	876	876	0
	Y	755	755	0
	Z	812	812	0
LEG AND FOOT:				
45. Lat. Femoral Condyle . .	X	1115	1115	0
	Y	738	740	+2
	Z	497	497	0
46. Med. Femoral Epicondyle .	X	1120	1120	0
	Y	651	652	+1
	Z	494	494	0
47. Tibiale	X	1133	1133	0
	Y	654	655	+1
	Z	483	483	0
48. Patella	X	1159	1156	-3
	Y	700	700	0
	Z	516	516	0
49. Sphyrion	X	1354	1354	0
	Y	676	684	+8
	Z	253	247	-6
50. Metatarsal/Phalangeal I .	X	1453	1453	0
	Y	695	699	+4
	Z	305	305	0

TABLE L.2
SMALL FEMALE SHELL LABORATORY COORDINATES (Continued)

Reference No. and Landmark	Coord.	Desired	Actual	Diff.
LEG AND FOOT (Continued)				
51. Digit II	X	1184	1184	0
	Y	745	748	+3
	Z	351	350	-1
52. Metatarsal/Phalangeal V .	X	1438	1438	0
	Y	776	780	+4
	Z	278	278	0
53. Lateral Malleolus	X	1339	1339	0
	Y	734	743	+9
	Z	231	231	0
ANTHRO. MEASUREMENT POINTS				
93. Neck, mid	X	569	569	0
	Y	665	664	-1
	Z	881	881	0
94. Neck, lower	X	562	562	0
	Y	671	671	0
	Z	856	857	+1
95. Arm, upper	X	658	658	0
	Y	818	818	0
	Z	731	731	0
96. Forearm, upper	X	813	813	0
	Y	826	827	+1
	Z	688	688	0
97. Forearm, lower	X	853	853	0
	Y	809	809	0
	Z	751	751	0
98. Thigh, upper	X	868	868	0
	Y	788	790	+2
	Z	458	458	0
99. Thigh, mid	X	976	976	0
	Y	766	769	+3
	Z	483	483	0
100. Calf	X	1198	1198	0
	Y	755	759	+4
	Z	381	381	0
101. Ankle	X	1281	1281	0
	Y	736	743	+7
	Z	293	293	0

*Cannot measure on shell.

TABLE L.3

MID-SIZED MALE SURFACE SHELL ANTHROPOMETRY
(Desired vs. Actual, cm or as noted)

Measurement Variable	Desired	Actual	Diff.
Sitting Height	100.3	99.9	-0.4
Cervicale Height	75.3	75.3	0.0
Chin Height	77.4	77.4	0.0
Head Breadth	15.8	15.9	+0.1
Head Height	23.1	23.1	0.0
Head Length	19.7	19.7	0.0
Head Circumference	57.1	57.1	0.0
Neck Length (anterior)	8.5	*	*
Neck Breadth (mid)	11.4	11.6	+0.2
Neck Depth (mid)	11.5	11.8	+0.3
Neck Circumference (mid)	38.3	38.3	0.0
Neck Breadth (lower)	12.2	12.4	+0.2
Neck Depth (lower)	11.5	11.8	+0.3
Neck Circumference (lower)	39.3	39.0	-0.3
Shoulder Height (mid)	72.1	72.0	-0.1
Acromion Height	68.3	68.4	+0.1
Clav.-to-Acr. Clav. Artic	17.4	17.5	+0.1
Shoulder Breadth	46.8	46.8	0.0
Shoulder Circumference	120.0	120.0	0.0
Biacromial Breadth	40.7	40.7	0.0
Torso Depth (upper)	11.9	11.4	-0.5
Shoulder Depth (scye)	14.5	13.9	-0.6
Axillary Depth	11.7	*	*
Arm Angle (upper)	40.0°	38.0°	-2.0°
Arm Angle (lower)	36.0°	38.0°	+2.0°
Right-Left Med. Hum. Epicondyle	33.8	32.3	-1.5
Right-Left Stylion	27.0	27.0	0.0
Arm Circumference (scye)	45.3	*	*
Arm Breadth (upper)	8.6	8.6	0.0
Arm Depth (upper)	10.8	10.5	-0.3
Arm Circumference (upper)	31.5	*	*
Arm Breadth (above elbow)	8.3	8.4	+0.1
Arm Depth (above elbow)	8.2	8.3	+0.1
Arm Circumference (above elbow)	28.4	28.4	0.0
Olecranon Height	45.0	45.0	0.0
Elbow Breadth	8.0	8.0	0.0
Elbow Depth	9.2	9.6	+0.4
Elbow Circumference	28.5	28.3	-0.2
Forearm Breadth (upper)	8.2	8.3	+0.1
Forearm Depth (upper)	8.6	8.8	+0.2
Forearm Circumference (upper)	27.5	27.4	-0.1
Forearm Circumference (lower)	18.3	17.5	-0.8
Wrist Breadth (condyles)	5.9	6.0	+0.1

TABLE L.3
MID-SIZED MALE SHELL ANTHROPOMETRY (Continued)

Measurement Variable	Desired	Actual	Diff.
Wrist Depth (condyles)	4.1	4.5	+0.4
Wrist Circumference (condyles)	16.9	16.9	0.0
Chest Height (nipple)	55.4	*	*
Chest Height (posterior scye) . .	57.0	56.9	-0.1
Chest Breadth (axilla)	30.4	30.4	0.0
Chest Circumference (axilla) . .	103.9	*	*
Chest Breadth (nipple)	34.9	*	*
Chest Circumference (nipple) . .	101.0	100.7	-0.3
Chest Circumference (10th rib)	90.9	90.6	-0.3
Waist Breadth (umbilicus)	31.4	31.5	+0.1
Waist Depth (umbilicus)	24.4	25.2	+0.8
Waist Circumference (umbilicus)	90.4	91.7	+1.3
Abdominal Breadth (max.)	32.5	32.6	+0.1
Abdominal Depth (max.)	26.9	26.0	-0.9
Abdominal Circumference (max.)	91.3	94.7	+3.4
Iliocristale Height	35.7	35.6	-0.1
Thigh-Abdom. Junct. Height . . .	34.5	34.5	0.0
Ant.-Sup. Iliac Spine Height . .	34.7	*	*
Trochanterion Height	29.2	29.2	0.0
Hip Breadth (max.)	38.5	39.4	+0.9
Bitrochanter Breadth	32.9	*	*
Leg Angle (upper)	18.0°	17.0°	-1.0°
Leg Angle (lower)	53.0°	53.0°	0.0°
Right-Left Med. Fem. Epicondyle	17.4	17.4	0.0
Right-Left Sphyrion	12.2	12.3	+0.1
Troc.-to-Lat. Fem. Condyle . . .	44.7	44.7	0.0
Thigh Breadth (upper)	19.4	19.3	-0.1
Thigh Circumference (upper) . . .	57.9	58.7	+0.8
Thigh Breadth (mid)	15.5	15.7	+0.2
Thigh Circumference (mid)	50.4	50.2	-0.2
Knee Height	45.3	45.5	-0.2
Knee Breadth	10.1	10.4	+0.3
Knee Depth (popliteal)	13.2	13.1	-0.1
Knee Circumference	39.2	39.1	-0.1
Calf Breadth	11.0	11.0	0.0
Calf Depth	11.8	11.9	+0.1
Calf Circumference	37.3	37.3	0.0
Ankle Breadth (min.)	6.1	6.3	+0.2
Ankle Depth (min.)	7.6	7.6	0.0
Ankle Circumference (min.) . . .	22.9	22.9	0.0
Ankle Breadth (condyles)	7.3	7.6	+0.3
Ankle Depth (condyles)	9.4	10.7	+1.3
Ankle Circumference (condyles)	26.1	28.3	+2.2

*Cannot measure on shell.

TABLE L.4

MID-SIZED MALE SURFACE SHELL LANDMARK LABORATORY COORDINATES
(Desired vs. Actual, mm)

Reference No. and Landmark	Coord.	Desired	Actual	Diff.
HEAD AND NECK:				
1. Glabella	X	577	575	-2
	Y	619	615	-4
	Z	1073	1065	-8
2. Infraorbitale	X	561	562	+1
	Y	653	650	-3
	Z	1042	1042	0
3. Tragon	X	472	467	+5
	Y	702	697	-5
	Z	1036	1036	0
4. Gonion	X	484	479	-5
	Y	689	684	-5
	Z	966	965	-1
5. Gnathion	X	556	558	+2
	Y	619	616	-3
	Z	933	933	0
SPINE AND SCAPULA:				
7. C7	X	391	391	0
	Y	619	617	-2
	Z	911	912	+1
8. T4	X	364	365	+1
	Y	619	619	0
	Z	802	802	0
9. T8	X	373	372	-1
	Y	619	619	0
	Z	675	675	0
10. T12	X	411	409	-2
	Y	619	619	0
	Z	568	568	0
11. L2	X	440	437	-3
	Y	619	620	+1
	Z	509	509	0
12. L5	X	483	482	-1
	Y	619	621	+2
	Z	435	433	-2

TABLE L.4
MID-SIZED MALE SHELL LABORATORY COORDINATES (Continued)

Reference No. and Landmark	Coord.	Desired	Actual	Diff.
SPINE AND SCAPULA (Continued)				
13. 10th Rib, mid-spine . . .	X	415	413	-2
	Y	619	620	+1
	Z	560	559	-1
14. Scapula, Sup. Marg. . . .	X	361	363	+2
	Y	698	699	+1
	Z	825	825	0
15. Scapula, Inf. Marg. . . .	X	381	379	-2
	Y	745	745	0
	Z	689	689	0
CHEST AND TORSO:				
18. Suprasternale	X	518	518	0
	Y	619	617	-2
	Z	857	857	0
19. Mesosternale	X	559	557	-2
	Y	619	617	-2
	Z	807	807	0
20. Substernale	X	585	583	-2
	Y	619	617	-2
	Z	758	758	0
21. Bimammary Midline	X	605	605	0
	Y	619	617	-2
	Z	703	703	0
22. Nipple	X	605	604	-1
	Y	732	731	-1
	Z	712	712	0
23. 10th Rib, Ant. Midline .	X	672	669	-3
	Y	619	618	-1
	Z	613	614	+1
24. Umbilicus	X	692	688	-4
	Y	619	618	-1
	Z	575	570	+1
25. Max. Abdom. Protrusion .	X	713	708	-5
	Y	619	619	0
	Z	551	551	0
26. 10th Rib	X	564	564	0
	Y	775	781	+6
	Z	556	556	0

TABLE L.4
MID-SIZED MALE SHELL LABORATORY COORDINATES (Continued)

Reference No. and Landmark	Coord.	Desired	Actual	Diff.
PELVIS AND HIP:				
27. Iliocristale	X	577	577	0
	Y	780	786	+6
	Z	515	515	0
28. Ant. Sup. Iliac Spine . .	X	632	*	*
	Y	735	*	*
	Z	505	*	*
29. Pubic Symphysis	X	708	*	*
	Y	619	*	*
	Z	463	*	*
30. Thigh-Abdom. Junction . .	X	678	676	-2
	Y	741	744	+3
	Z	503	505	+2
31a. Trochanterion (palpated)	X	624	624	0
	Y	807	816	+9
	Z	450	451	+1
31b. Trochanterion (reconstr.)	X	---	677	--
	Y	---	822	--
	Z	---	402	--
SHOULDER:				
33. Clavicale	X	512	513	+1
	Y	642	640	-2
	Z	865	865	0
34. Acromio-Clavicular Artic.	X	442	442	0
	Y	801	801	0
	Z	865	867	+2
35. Gr. Tubercle Humerus . .	X	484	483	-1
	Y	837	837	0
	Z	843	841	-2
36. Acromion	X	433	433	0
	Y	822	825	+3
	Z	841	844	+3
37. Scye, anterior	X	560	557	-3
	Y	773	772	-1
	Z	802	802	0
38. Scye, posterior	X	443	442	-1
	Y	816	812	-4
	Z	728	726	-2

TABLE L.4
MID-SIZED MALE SHELL LABORATORY COORDINATES (Continued)

Reference No. and Landmark	Coord.	Desired	Actual	Diff.
ARM AND HAND:				
39. Lat. Humeral Epicondyle .	X	689	687	-2
	Y	861	862	+1
	Z	646	646	0
40. Radiale	X	703	701	-2
	Y	862	856	-6
	Z	631	631	0
41. Med. Humeral Epicondyle .	X	689	686	-3
	Y	792	795	+3
	Z	621	620	-1
42. Olecranon	X	710	710	0
	Y	829	826	-3
	Z	608	607	-1
43. Ulnar Styloid	X	883	883	0
	Y	810	809	-1
	Z	809	809	0
44. Stylium	X	868	865	-3
	Y	754	753	-1
	Z	821	821	0
LEG AND FOOT:				
45. Lat. Femoral Condyle . .	X	1061	1060	-1
	Y	808	808	0
	Z	551	552	+1
46. Med. Femoral Epicondyle .	X	1064	1061	-3
	Y	706	708	+2
	Z	564	566	+2
47. Tibiale	X	1081	1079	-2
	Y	707	709	+2
	Z	550	552	+2
48. Patella	X	1106	1103	-3
	Y	769	769	0
	Z	594	596	+2
49. Sphyrion	X	1341	1341	0
	Y	680	683	+3
	Z	273	273	0
50. Metatarsal/Phalangeal I .	X	1453	1453	0
	Y	703	707	+4
	Z	336	336	0

TABLE L.4
MID-SIZED MALE SHELL LABORATORY COORDINATES (Continued)

Reference No. and Landmark	Coord.	Desired	Actual	Diff.
LEG AND FOOT (Continued)				
51. Digit II	X	1496	1504	+8
	Y	766	769	+3
	Z	385	381	-4
52. Metatarsal/Phalangeal V .	X	1442	1442	0
	Y	793	795	+2
	Z	298	298	0
53. Lateral Malleolus	X	1337	1339	+2
	Y	745	755	+10
	Z	237	237	0
ANTHRO. MEASUREMENT POINTS				
93. Neck, mid	X	459	459	0
	Y	676	673	-3
	Z	934	934	0
94. Neck, lower	X	453	453	0
	Y	680	678	-2
	Z	914	915	+1
95. Arm, upper	X	552	551	-1
	Y	850	850	0
	Z	758	758	0
96. Forearm, upper	X	767	767	0
	Y	853	852	-1
	Z	703	703	0
97. Forearm, lower	X	848	848	0
	Y	816	814	-2
	Z	775	775	0
98. Thigh, upper	X	788	788	0
	Y	816	820	+4
	Z	482	484	+2
99. Thigh, mid	X	883	882	-1
	Y	817	821	+4
	Z	511	511	0
100. Calf	X	1168	1168	0
	Y	799	805	+6
	Z	416	417	+1
101. Ankle	X	1281	1282	+1
	Y	752	760	+8
	Z	300	300	0

*Cannot measure on shell.

TABLE L.5

LARGE MALE SURFACE SHELL ANTHROPOMETRY
(Desired vs. Actual, cm or as noted)

Measurement Variable	Desired	Actual	Diff.
Sitting Height	102.9	103.4	+0.5
Cervicale Height	78.2	78.4	+0.2
Chin Height	80.6	80.6	0.0
Head Breadth	15.6	15.8	+0.2
Head Height	23.3	23.0	-0.3
Head Length	20.2	20.2	0.0
Head Circumference	59.6	60.0	+0.4
Neck Length (anterior)	9.8	*	*
Neck Breadth (mid)	12.6	12.8	+0.2
Neck Depth (mid)	12.6	13.0	+0.4
Neck Circumference (mid)	42.1	42.0	-0.1
Neck Breadth (lower)	13.6	13.8	+0.2
Neck Depth (lower)	13.1	13.8	+0.7
Neck Circumference (lower)	43.3	43.5	+0.2
Shoulder Height (mid)	74.7	74.8	+0.1
Acromion Height	70.5	70.4	-0.1
Clav.-to-Acr. Clavic. Artic	19.1	18.7	-0.4
Shoulder Breadth	50.2	50.2	0.0
Shoulder Circumference	131.7	131.7	0.0
Biacromial Breadth	43.4	43.4	0.0
Torso Depth (upper)	13.8	13.8	0.0
Shoulder Depth (scye)	15.7	17.0	-1.3
Axillary Depth	13.3	*	*
Arm Angle (upper)	37.0°	40.0°	+3.0°
Arm Angle (lower)	24.0°	24.0°	0.0°
Right-Left Med. Hum. Epicondyle	37.8	36.5	-1.3
Right-Left Stylium	27.5	27.5	0.0
Arm Circumference (scye)	50.6	*	*
Arm Breadth (upper)	9.8	9.8	0.0
Arm Depth (upper)	12.5	12.6	+0.1
Arm Circumference (upper)	35.8	36.0	+0.2
Arm Breadth (above elbow)	9.2	9.4	+0.2
Arm Depth (above elbow)	9.2	9.2	0.0
Arm Circumference (above elbow)	31.3	31.3	0.0
Olecranon Height	47.6	47.6	0.0
Elbow Breadth	8.5	8.6	+0.1
Elbow Depth	9.5	9.6	+0.1
Elbow Circumference	30.3	30.3	0.0
Forearm Breadth (upper)	8.5	9.0	+0.5
Forearm Depth (upper)	9.2	9.3	+0.1
Forearm Circumference (upper)	29.6	29.7	+0.1
Forearm Circumference (lower)	20.3	20.6	+0.3
Wrist Breadth (condyles)	6.2	6.3	+0.1

TABLE L.5
LARGE MALE SHELL ANTHROPOMETRY (Continued)

Measurement Variable	Desired	Actual	Diff.
Wrist Depth (condyles)	4.5	4.8	+0.3
Wrist Circumference (condyles)	18.1	18.0	-0.1
Chest Height (nipple)	57.1	*	*
Chest Height (posterior scye) .	57.9	57.9	0.0
Chest Breadth (axilla)	32.3	32.3	0.0
Chest Circumference (axilla) .	117.1	*	*
Chest Breadth (nipple)	38.4	*	*
Chest Circumference (nipple) .	115.9	*	*
Chest Circumference (10th rib)	106.5	*	*
Waist Breadth (umbilicus) . . .	36.1	39.0	+2.9
Waist Depth (umbilicus)	30.1	33.8	+3.7
Waist Circumference (umbilicus)	107.5	111.2	+3.7
Abdominal Breadth (max.)	38.4	40.0	+1.6
Abdominal Depth (max.)	31.6	34.2	+2.6
Abdominal Circumference (max.)	108.2	114.5	+6.3
Iliocristale Height	35.4	35.6	+0.2
Thigh-Abdom. Junct. Height . .	34.5	35.0	+0.5
Ant.-Sup. Iliac Spine Height .	34.9	*	*
Trochanterion Height	28.4	28.6	+0.2
Hip Breadth (max.)	43.9	45.7	+1.8
Bitrochanter Breadth	38.5	*	*
Leg Angle (upper)	19.0°	19.0°	0.0°
Leg Angle (lower)	52.0°	52.0°	0.0°
Right-Left Med. Fem. Epicondyle	19.6	19.1	-0.5
Right-Left Sphyrion	12.6	12.6	0.0
Troc.-to-Lat. Fem. Condyle . .	46.6	46.3	-0.3
Thigh Breadth (upper)	21.4	21.4	0.0
Thigh Circumference (upper) . .	63.9	64.1	-0.8
Thigh Breadth (mid)	16.9	16.9	0.0
Thigh Circumference (mid) . . .	55.9	58.0	+2.1
Knee Height	47.8	47.9	+0.1
Knee Breadth	11.1	11.3	-0.2
Knee Depth (popliteal)	14.5	14.4	-0.1
Knee Circumference	43.4	43.4	0.0
Calf Breadth	12.1	12.4	+0.3
Calf Depth	12.8	2.7	+0.1
Calf Circumference	40.6	40.7	+0.1
Ankle Breadth (min.)	6.6	6.8	+0.2
Ankle Depth (min.)	8.2	8.3	+0.1
Ankle Circumference (min.) . .	24.7	24.6	+0.1
Ankle Breadth (condyles) . . .	7.7	7.8	+0.1
Ankle Depth (condyles)	10.2	10.2	0.0
Ankle Circumference (condyles)	28.7	28.7	0.0

*Cannot measure on shell.

TABLE L.6
 LARGE MALE SURFACE SHELL LANDMARK LABORATORY COORDINATES
 (Desired vs. Actual, mm)

Reference No. and Landmark	Coord.	Desired	Actual	Diff.
HEAD AND NECK:				
1. Glabella	X	507	510	+3
	Y	619	616	-3
	Z	1093	1093	0
2. Infraorbitale	X	490	491	+1
	Y	656	651	-5
	Z	1059	1059	0
3. Tragion	X	406	410	+4
	Y	702	700	-2
	Z	1055	1057	+2
4. Gonion	X	423	423	0
	Y	689	687	-2
	Z	985	985	0
5. Gnathion	X	510	510	0
	Y	619	618	-1
	Z	964	962	-2
SPINE AND SCAPULA:				
7. C7	X	318	317	-1
	Y	619	618	-1
	Z	940	940	0
8. T4	X	285	285	0
	Y	619	619	0
	Z	830	830	0
9. T8	X	291	292	+1
	Y	619	619	0
	Z	693	693	0
10. T12	X	335	335	0
	Y	619	619	0
	Z	564	564	0
11. L2	X	372	371	-1
	Y	619	619	0
	Z	504	504	0
12. L5	X	416	416	0
	Y	619	619	0
	Z	428	428	0

TABLE L.6
LARGE MALE SHELL LABORATORY COORDINATES (Continued)

Reference No. and Landmark	Coord.	Desired	Actual	Diff.
SPINE AND SCAPULA (Continued)				
13. 10th Rib, mid-spine	X	341	341	0
	Y	619	619	0
	Z	553	553	0
14. Scapula, Sup. Marg.	X	287	287	0
	Y	702	702	0
	Z	855	855	0
15. Scapula, Inf. Marg.	X	317	317	0
	Y	766	766	0
	Z	680	680	0
CHEST AND TORSO:				
18. Suprasternale	X	456	457	+1
	Y	619	618	-1
	Z	868	868	0
19. Mesosternale	X	499	501	+2
	Y	619	618	-1
	Z	824	824	0
20. Substernale	X	529	530	+1
	Y	619	618	-1
	Z	773	773	0
21. Bimammary Midline	X	558	557	-1
	Y	619	618	-1
	Z	721	721	0
22. Nipple	X	559	559	0
	Y	751	751	0
	Z	729	729	0
23. 10th Rib, Ant. Midline	X	651	651	0
	Y	619	618	-1
	Z	627	627	0
24. Umbilicus	X	678	676	-2
	Y	619	619	0
	Z	581	581	0
25. Max. Abdom. Protrusion	X	693	693	0
	Y	619	619	0
	Z	562	562	0
26. 10th Rib	X	492	492	0
	Y	813	814	+1
	Z	552	552	0

TABLE L.6
LARGE MALE SHELL LABORATORY COORDINATES (Continued)

Reference No. and Landmark	Coord.	Desired	Actual	Diff.
PELVIS AND HIP:				
27. Iliocristale	X	504	504	0
	Y	816	817	+1
	Z	514	514	0
28. Ant. Sup. Iliac Spine . .	X	591	*	*
	Y	740	*	*
	Z	507	*	*
29. Pubic Symphysis	X	668	*	*
	Y	619	*	*
	Z	459	*	*
30. Thigh-Abdom. Junction . .	X	637	638	+1
	Y	774	775	+1
	Z	503	506	+3
31a. Trochanterion (palpated)	X	584	584	0
	Y	836	841	+5
	Z	442	442	0
31b. Trochanterion (reconstr.)	X	---	640	--
	Y	---	834	--
	Z	---	387	--
SHOULDER:				
33. Clavicale	X	447	551	+4
	Y	644	644	0
	Z	882	878	-4
34. Acromio-Clavicular Artic.	X	371	371	0
	Y	811	811	0
	Z	889	890	+1
35. Gr. Tubercle Humerus . .	X	433	433	0
	Y	842	842	0
	Z	878	881	+3
36. Acromion	X	362	362	0
	Y	836	836	0
	Z	863	864	+1
37. Scye, anterior	X	503	504	+1
	Y	786	780	-6
	Z	830	830	0
38. Scye, posterior	X	373	373	0
	Y	840	837	-3
	Z	737	737	0

TABLE L.6
LARGE MALE SHELL LABORATORY COORDINATES (Continued)

Reference No. and Landmark	Coord.	Desired	Actual	Diff.
ARM AND HAND:				
39. Lat. Humeral Epicondyle .	X	652	652	0
	Y	885	886	+1
	Z	679	679	0
40. Radiale	X	670	670	0
	Y	880	879	-1
	Z	661	661	0
41. Med. Humeral Epicondyle .	X	645	645	0
	Y	808	808	0
	Z	645	645	0
42. Olecranon	X	666	666	0
	Y	853	853	0
	Z	634	636	+2
43. Ulnar Styloid	X	880	880	0
	Y	816	817	+1
	Z	807	807	0
44. Stylium	X	863	863	0
	Y	757	758	+1
	Z	823	823	0
LEG AND FOOT:				
45. Lat. Femoral Condyle . .	X	1029	1029	0
	Y	826	828	+2
	Z	566	566	0
46. Med. Femoral Epicondyle .	X	1032	1032	0
	Y	717	716	-1
	Z	584	584	0
47. Tibiale	X	1051	1051	0
	Y	716	717	+1
	Z	572	572	0
48. Patella	X	1078	1078	0
	Y	787	787	0
	Z	611	611	0
49. Sphyrion	X	1339	1339	0
	Y	682	684	+2
	Z	278	278	0
50. Metatarsal/Phalangeal I .	X	1463	1463	0
	Y	707	707	0
	Z	339	339	0

TABLE L.6
LARGE MALE SHELL LABORATORY COORDINATES (Continued)

Reference No. and Landmark	Coord.	Desired	Actual	Diff.
LEG AND FOOT (Continued)				
51. Digit II	X	1507	1507	0
	Y	769	769	0
	Z	392	392	0
52. Metatarsal/Phalangeal V .	X	1450	1450	0
	Y	803	802	-1
	Z	304	304	0
53. Lateral Malleolus	X	1329	1329	0
	Y	754	755	+1
	Z	240	240	0
ANTHRO. MEASUREMENT POINTS				
93. Neck, mid	X	392	392	0
	Y	682	680	-2
	Z	953	953	0
94. Neck, lower	X	385	385	0
	Y	687	686	-1
	Z	929	929	0
95. Arm, upper	X	508	508	0
	Y	872	872	0
	Z	786	786	0
96. Forearm, upper	X	740	740	0
	Y	871	873	+2
	Z	727	727	0
97. Forearm, lower	X	834	834	0
	Y	830	832	+2
	Z	781	781	0
98. Thigh, upper	X	751	751	0
	Y	844	848	+4
	Z	489	489	0
99. Thigh, mid	X	842	842	0
	Y	843	845	+2
	Z	521	521	0
100. Calf	X	1150	1150	0
	Y	818	823	+5
	Z	427	427	0
101. Ankle	X	1281	1281	0
	Y	762	764	+2
	Z	298	298	0

*Cannot measure on shell.